

fiora | TOUCH
YOUR
BATHROOM

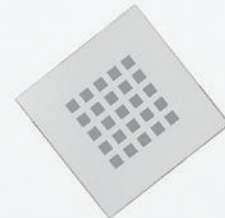

The Catalogue 01B

The Catalogue

fiora

fiora

En Fiora diseñamos, proyectamos y producimos soluciones globales para el baño.

In Fiora design, we design and produce global solutions for the bathroom.

Chez Fiora nous concevons, développons et produisons des solutions globales pour la salle de bains.

Fiora ontwerpt, plant en vervaardigt integrale oplossingen voor de badkamer.

The Catalogue

ESPAÑOL

Fiora diseña, proyecta y produce soluciones globales para el baño.

Platos de ducha, paneles para paredes, radiadores, muebles y lavabos con (y sin) texturas únicas para tocar.

En Fiora estamos convencidos de que podemos mejorar la vida de las personas. Por este motivo, dedicamos tiempo para la innovación de nuestros productos desde diferentes puntos de vista: funcionales, estéticos, tecnológicos, etc.

Este nuevo catálogo se ha realizado pensando en desarrollar una herramienta práctica y eficaz, capaz de transmitir los resultados de nuestro trabajo diario.

ENGLISH

Fiora designs, plans and produces global solutions for the bathroom.

Shower trays, wall panels, radiators, furniture and wash basins with (and without) unique textures for touching.

At Fiora we're convinced that we can improve the lives of people. As a result, we dedicate time to the innovation of our products from different points of view: functional, aesthetic, technological, etc.

This new catalogue has been made with the aim of developing a practical and effective tool, capable of communicating the results of our daily work.

FRANÇAIS

Fiora conçoit, développe et produit des solutions globales pour la salle de bains.

Receveurs de Douche, Panneaux d'habillage, radiateurs, meubles avec ou sans vasques. Des textures uniques au toucher.

Chez Fiora, nous sommes convaincus de pouvoir améliorer la vie de tous. C'est pour cette raison que nous investissons dans l'innovation de nos produits, selon différents points de vue: fonctionnels, esthétiques, technologiques, etc.

Ce nouveau catalogue a été réalisé pour vous fournir un outil pratique et efficace, dans le but de transmettre les résultats de notre travail au quotidien.

DUTCH

Fiora ontwerpt, plant en vervaardigt integrale oplossingen voor de badkamer.

Douchebakken, wandpanelen, radiatoren, meubels en wastafels met (en zonder) unieke texturen.

Bij Fiora zijn we ervan overtuigd dat we het leven van mensen kunnen verbeteren. Daarom besteden wij tijd aan de vernieuwing van onze producten vanuit functioneel, esthetisch en technologisch oogpunt.

Deze nieuwe catalogus is ontworpen met de bedoeling een praktisch en doeltreffend instrument samen te stellen, waarin de resultaten van ons dagelijks werk zijn weergegeven.

Since 1983,

Hitos históricos de nuestra compañía
Historical milestones of our company
Les grandes dates de notre société
Historische mijlpalen van ons bedrijf

.....
1983

PRIMER hito
“Muebles fabricados en poliuretano.”

FIRST milestone
“Furniture made in polyurethane.”

PREMIÈRE date « Des meubles fabriqués en polyuréthane. »

EERSTE mijlpaal “Meubels vervaardigd van polyurethaan.”



General Catalogue 1983

.....
1989

SEGUNDO hito
“Nuevos productos. Colecciones Época y Castilla ”

SECOND milestone “New products. Época and Castilla collections ”

DEUXIÈME date « Nouveaux produits. Les collections Époque et Castilla »

TWEEDE mijlpaal “Nieuwe producten. Collecties Época en Castilla ”

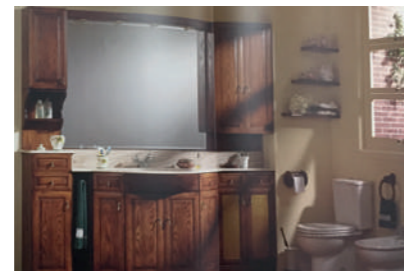

General Catalogue 1989

.....
2000

TERCER hito
Catálogo General.
“Diseño, diseño y más diseño.”

THIRD milestone General Catalogue.
“Design, design and more design.”

TROISIÈME date Catalogue Général.
« Design, design et encore du design »

DERDE mijlpaal Algemene Catalogus.
“Ontwerp, ontwerp en nog meer ontwerp.”

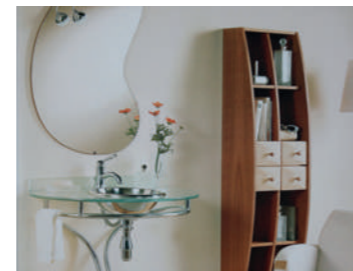

Serie 2000 Catalogue 2000

.....
2004

CUARTO hito
“TOTEM. Descubrimos las texturas y la vanguardia”

FOURTH milestone “TOTEM. We discover the textures and the cutting edge”

QUATRIÈME date « TOTEM. Découverte des textures et de l'innovation »

VIERDE mijlpaal “TOTEM. Wij ontdekken de texturen en de avant-garde”



TOTEM Catalogue 2004

.....
2008

QUINTO hito
“SILEX. Primer plato de ducha con textura y a medida.”

FIFTH milestone “SILEX. The first shower tray with texture and made to measure.”

CINQUIÈME date « SILEX. Le premier Receveur de Douche texturé et sur mesure. »

VIJFDE mijlpaal “SILEX. Eerste op maat gemaakte douchebak met textuur.”



SILEX Catalogue 2008

.....
2017

SEXTO hito
“Nuevas gamas de producto con texturas: paneles...”

SIXTH milestone “New product ranges with textures: panels...”

SIXIÈME date « Nouvelles gammes de produits texturés: panneaux... »

ZESDE mijlpaal “Nieuwe productengamma's met texturen: panelen...”



General Catalogue 2017

hello!!



BIENVENIDOS A FIORA

WELCOME TO FIORA | BIENVENUE CHEZ FIORA | WELKOM BIJ FIORA

Fiora cuenta con una planta de producción dividida en 4 bloques (+ de 20.000m²) dedicados a diferentes productos: muebles, radiadores y lavabos, paneles y platos de ducha. Todos ellos articulados desde un quinto bloque cuyo objetivo es la organización.

Fiora s'appuie sur une usine de production répartie en 4 ateliers (+ de 20 000m²) dédiés aux différents produits : meubles, radiateurs, vasques, panneaux et receveurs de douche. Tout est géré à partir d'un cinquième bâtiment qui a pour objectif de veiller à l'organisation.

Fiora has a production plant divided in four blocks (+ than 20.000m²) dedicated to different products: furniture, radiators and wash basins, panels and shower trays. All of them managed from a fifth block the aim of which is to provide organisation.

Fiora beschikt over een productievestiging die verdeeld is in 4 blokken (+ van 20.000m²) die zich toespitsen op verschillende producten: meubels, radiatoren en wastafels, panelen en douchebakken. Deze worden gestuurd vanuit een vijfde blok waar alles georganiseerd wordt.

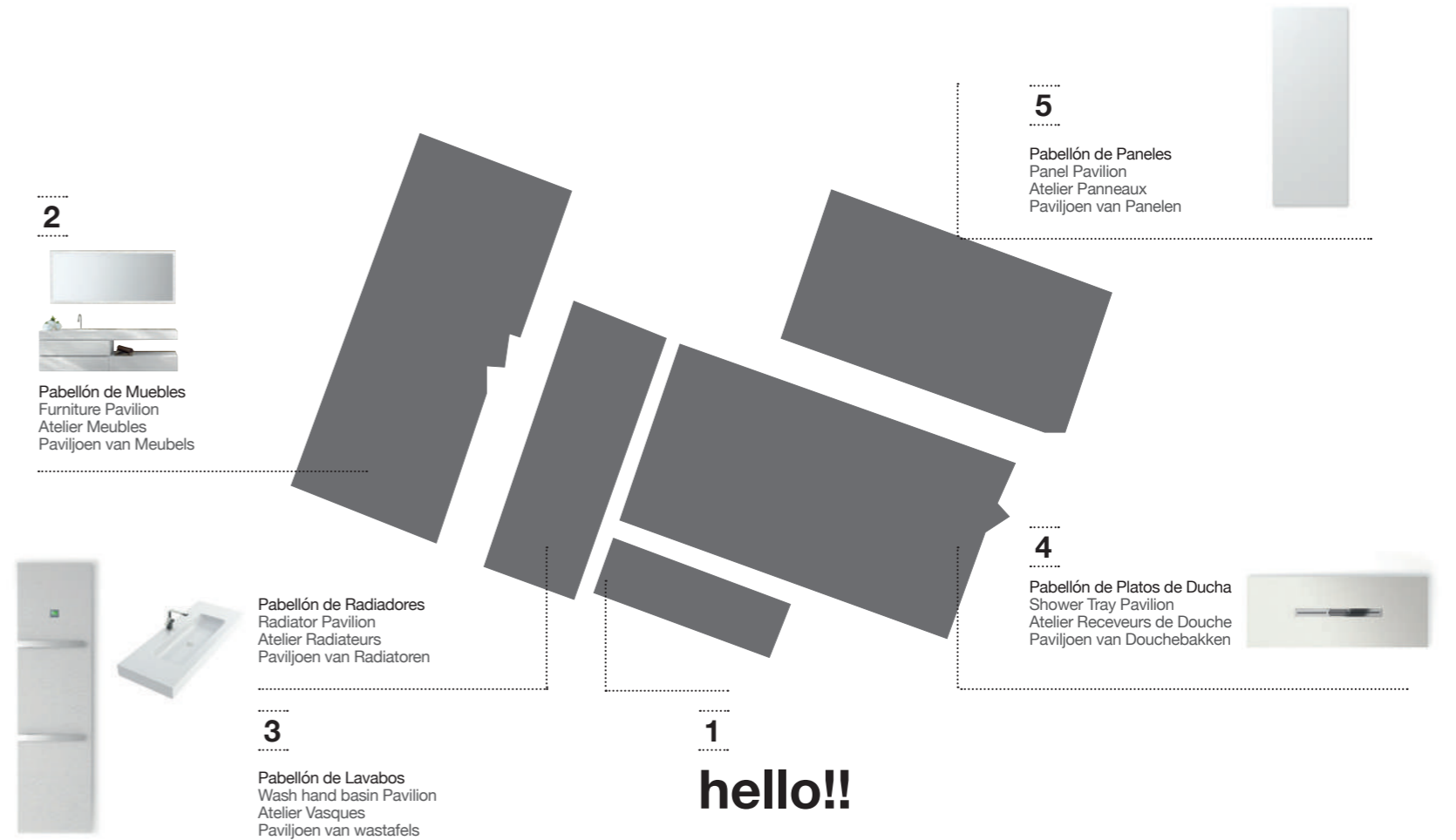

La Rioja (Spain)



ESTAMOS EN LA RIOJA. ESTAMOS EN EL MUNDO

WE ARE IN LA RIOJA. WE ARE AROUND THE WORLD | NOUS NOUS TROUVONS EN RIOJA. NOUS NOUS TROUVONS AU CŒUR DU MONDE | WIJ BEVINDEN ONS IN LA RIOJA. WIJ BEVINDEN ONS IN DE WERELD

Situados en La Rioja, zona norte de la península. En nuestra tierra, cerca de todo y con enorme vocación internacional.

Located in La Rioja, in the north of the peninsula. In our land, close to everything and with an enormous international vocation.

Nos ateliers se trouvent en Rioja, au nord de la péninsule. Sur notre terre, proche de tout et tournée vers l'international.

Gelegen in La Rioja, in het noorden van het schiereiland. In onze streek, dicht bij alles en met een uitgesproken internationale focus.

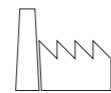
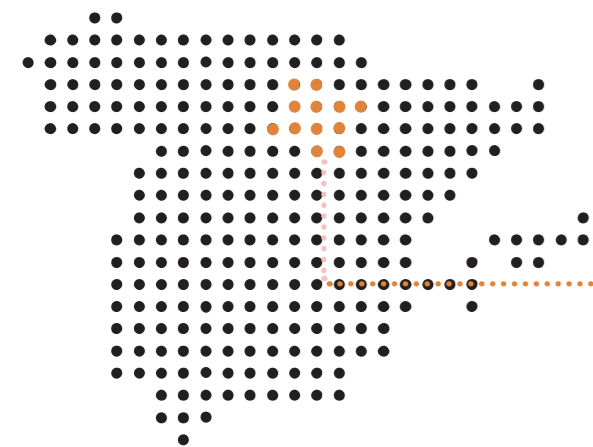

NÁJERA (La Rioja)
NÁJERA (La Rioja)
NÁJERA (La Rioja)
NÁJERA (La Rioja)



MAD - BCN - BIO

350 km a Madrid. 495 km a Barcelona, 120 km a Bilbao
350 km from Madrid. 495 km from Barcelona, 120 km from Bilbao
350 km de Madrid. 495 km de Barcelone, 120 km de Bilbao
350 km van Madrid. 495 km van Barcelona, 120 km van Bilbao

Distribuidores
Distributors
Distributeurs
Distributeurs

EUROPE
Germany
France
United Kingdom
Holland
Belgium
Portugal
Italy
Ireland
Luxembourg
Croatia
Slovenia
Switzerland
Austria

AMERICA
USA
Canada
Mexico

ASIA
Lebanon



Working,



CON CAPACIDAD DE PRODUCCIÓN

WITH PRODUCTION CAPACITY | AVEC UNE GRANDE CAPACITÉ DE PRODUCTION | MET PRODUCTIECAPACITEIT

En Fiora contamos con un sistema de trabajo de última tecnología que garantiza un alta capacidad productiva con la máxima calidad.

Chez Fiora, nous nous appuyons sur un système de travail de toute dernière technologie qui nous assure une grande capacité de production, d'une qualité maximale.

At Fiora we have a cutting-edge technology working system that guarantees high production capacity with the highest quality.

Fiora beschikt over een bijzonder geavanceerd werksysteem dat een hoge productiecapaciteit garandeert met de hoogste kwaliteit.

IN 2016:

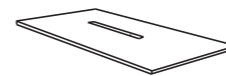

83.740

Platos de Ducha
Shower Trays
Receveurs de Douche
Douchebakken

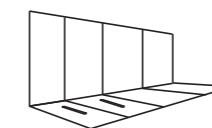

25.220M²

Paneles para paredes
Wall panels
Panneaux d'habillage
Wandpanelen



1.435

Radiadores
Radiators
Radiateurs
Radiatoren



3.240

Muebles de baño & Lavabos
Bathroom furniture & Wash basins
Meubles de salle de bains & Vasques
Badkamermeubels & Wastafels

With technology

ÚLTIMA TECNOLOGÍA PRODUCTIVA

THE LATEST PRODUCTION TECHNOLOGY | UNE PRODUCTION DE TOUTE DERNIÈRE TECHNOLOGIE | LAATSTE PRODUCTIETECHNOLOGIE

Los procesos de fabricación de todos los productos cuentan con tecnología de última generación para texturizado, barnizado, etc. sin incidencias.

The manufacturing processes of all the products using cutting-edge technology for texturising, varnishing, etc. without incidents.

Les processus de fabrication de tous nos produits possèdent une technologie de pointe pour une texturisation, un vernissage, etc. sans faille.

De vervaardigingsprocessen van alle producten beschikken over de modernste technologie voor het probleemloos texturiseren, lakken, enz.

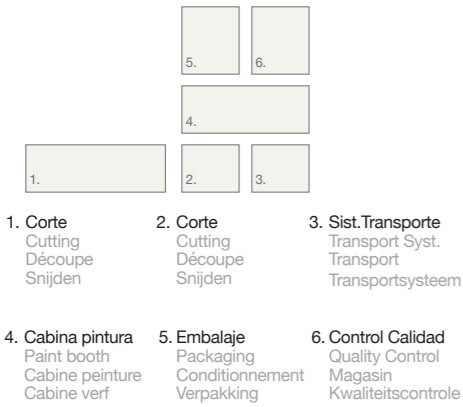



With care,

Los procesos de barnizado se realizan en 800 m² de cabinas personalizadas de última tecnología.

Les processus de vernissage sont réalisés dans 800 m² de cabinas personnalisées de toute dernière technologie.

The varnishing processes are carried out in 800 m² of cutting-edge technology tailored booths.

Het lakproces vindt plaats in een ruimte van 800 m² met de meest geavanceerde gepersonaliseerde cabinen.



With people,

PERSONAS QUE DISFRUTAN

PEOPLE WHO ENJOY | UN PERSONNEL ÉPANOUÍ | PERSONEN DIE GENIETEN

Ellos son el motor de la compañía. Personas con ilusión que se han comprometido para dar lo mejor de sí y eso, se nota.

Ce sont eux le moteur de notre société. Des personnes passionnées qui se sont engagées pour apporter le meilleur d'elles-mêmes, et ça se voit.

They are the company's driving force. Enthusiastic people who are committed to giving it their best, and that shows.

Zij zijn de stuwende kracht van de onderneming. Enthousiaste personen die er zich toe verbonden hebben om het beste van zichzelf te geven, en dat is duidelijk.

31/12/2016:



39

Hombres
Men
Hommes
Mannen



30

Mujeres
Women
Femmes
Vrouwen



41

Años de media
Average age
Moyenne d'âge
Gemiddelde leeftijd



5

Nacionalidades
Nationalities
Nationalités
Nationaliteiten



Responsability
Engagement
Creativity
Tenaciousness
Flexibility
Effectiveness
Collaboration

...



Searching and Innovating,

IDEAS Y SOLUCIONES

IDEAS AND SOLUTIONS | CAPACITÉ DE PRODUCTION | IDEEËN EN OPLOSSINGEN

Nuestro departamento de Diseño de Producto (6 personas) se fundamenta en un principio básico: trabajar sin darse nunca por satisfechos.

Notre département de Conception de Produit (6 personnes) se fonde sur un principe de base : travailler en allant au-delà de la satisfaction.

Our Product Design department (6 people) is based on a basic principle: working without ever becoming complacent.

Onze afdeling Productontwerp (6 personen) is gebaseerd op een basisprincipe: werken zonder ooit genoeg te nemen.

And showing... EXPERIENCE ROOM **fiora**



IN 2016:



EXPERIENCE ROOM FIORA es un espacio para el encuentro y la exposición de nuestros productos. Situado en Logroño, cuenta con 135m² para ruedas de prensa, eventos sociales y culturales, etc. Siempre en contacto con nuestro entorno.

L'EXPERIENCE ROOM FIORA est un espace de rencontres et d'exposition de nos produits. Il se trouve à Logroño, et compte sur 135m² pour des conférences de presse, des manifestations sociales et culturelles, etc. En contact permanent avec notre environnement.

EXPERIENCE ROOM FIORA is a space for finding and exhibiting our products. Located in Logroño, it has 135m² for press conferences, social and cultural events, etc. Always in touch with our surroundings.

EXPERIENCE ROOM FIORA is een ruimte waar ontmoetingen georganiseerd worden en onze producten tentoongesteld worden. De 135 m² grote ruimte is gelegen in Logroño en wordt² gebruikt voor persconferenties, sociale en culturele evenementen, enz. Steeds in contact met onze omgeving.



135M²

Exposición
Exhibition
Exposition
Toonzaal



650

Personas
People
Personnes
Personen



Meetings!

Eventos & Encuentros
Events & Meetings
Meubles pour la salle de bain & Bassins
Evenementen & Ontmoetingen

- Inauguración Experience Room Fiora 02/12/2015
- Programa Radio "La mañana de la COPE" 16/12/2015
- Idiomas y vino 28/12/2015
- Tercer tiempo de Fiora 02/03/2016
- Exposición "Mixturas de Fiora" 21/04/2016
- Rueda de prensa I Trofeo Fiora 12/05/2016
- El Sonido de las texturas de Fiora 20/05/2016
- Versos para las texturas de Fiora 16/06/2016
- Presentación Nueva Campaña publicitaria Fiora 29/09/2016
- Presentación Equipo FIORA DAKAR Team 01/12/2016

All fióra



Productos para proyectos integrales de baño
Products for integral bathroom projects
Produits pour projets complets de salle de bains
Producten voor integrale badkamerprojecten

Productos para una solución global de baño: platos de ducha, paneles para paredes, muebles y radiadores que pueden estar coordinados en texturas y colores.

Products for a global bathroom solution: shower trays, wall panels, furniture and radiators that can be coordinated by textures and colours.

Des produits pour une solution globale de la salle de bains : Receveurs de Douche, Panneaux d'habillage, meubles et radiateurs qui se coordonnent en textures et couleurs.

Producten voor een integrale oplossing voor de badkamer: douchebakken, wandpanelen, meubels en radiatoren die op elkaar kunnen worden afgestemd qua texturen en kleuren.

GAMA DE PRODUCTOS | PRODUCT RANGE | GAMME DE PRODUITS | PRODUCTENGAMMA

15 Texturas

15 Textures
 15 Textures
 15 Texturen

+

Infinidad de Colores

Infinite Colours
 Une Infinité de Couleurs
 Talloze Kleuren

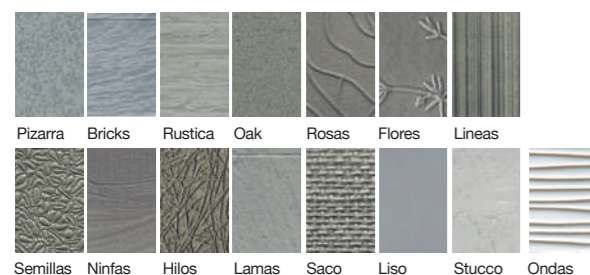

Plato de Ducha
Shower Tray
Receveur de Douche
Douchebak

Privilege
 Silex
 Avant
 Elax
 Essential



Paneles para alicatar
Wall panels
Panneaux d'habillage
Wandpanelen

Skin



Radiadores
Radiators
Radiateurs
Radiatoren

Vulcano Electric
 Vulcano Hydro



Muebles de baño
Bathroom furniture
Meubles de salle de bain
Badkamermeubels

Making
 Intouch
 Vivaldi



Lavabos & Consolas
Wash basins & Consoles
Vasques & Consoles
Wastafels & Consoles

Fontana



Platos de Ducha | Shower Trays | Receveurs de Douche | Douchebakken

Privilege

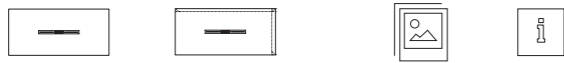
	PAGE 44 Extraplano Extra flat Extra-plat Extra vlak	PAGE 46 Enmarcado a medida Framed to measure Avec cadre sur mesure Omlijst op maat	PAGE 36 Imágenes Images Images Afbeeldingen	PAGE 50 Info.Técnica Technical Info Info Technique Technische Info.
				



Essential

	PAGE 90 Essential Essential Essential Essential	PAGE 84 Imágenes Images Images Afbeeldingen	PAGE 94 Info.Técnica Technical Info Info Technique Technische Info.
			

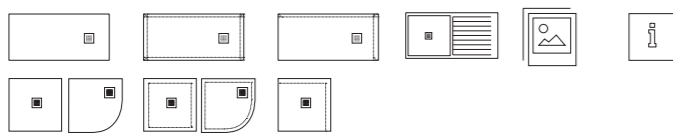

Silex

	PAGE 60 Extraplano Extra flat Extra-plat Extra vlak	PAGE 62 Enmarcado Framed Avec cadre Omlijst	PAGE 64 A medida To measure Sur mesure Op maat	PAGE 66 Mixto Mixto Mixto Mixto	PAGE 52 Imágenes Images Images Afbeeldingen	PAGE 70 Info.Técnica Technical Info Info Technique Technische Info.
						

Avant

	PAGE 80 Avant Avant Avant Avant	PAGE 72 Imágenes Images Images Afbeeldingen	PAGE 82 Info.Técnica Technical Info Info Technique Technische Info.
			

Elax

	PAGE 106 Tea System Tea System Tea System Tea System	PAGE 110 Classic Classic Classic Classic	PAGE 96 Imágenes Images Images Afbeeldingen	PAGE 112 Info.Técnica Technical Info Info Technique Technische Info.
				

Radiadores | Radiators | Radiateurs | Radiatoren

Vulcano Electric

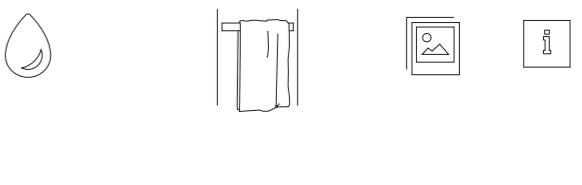

	PAGE 134 Sistema Instalación Installation system Système d'installation Montagesysteem	PAGE 136 Con toallero With towel holder Avec porte-serviettes Met handdoekrek	PAGE 132 Imágenes Images Images Afbeeldingen	PAGE 146 Info.Técnica Technical Info Info Technique Technische Info.
				

Vulcano Hydro

	PAGE 150 Sistema Instalación Installation system Système d'installation Montagesysteem	PAGE 154 Con toallero With tower holder Avec porte-serviettes Met handdoekrek	PAGE 148 Imágenes Images Images Afbeeldingen	PAGE 158 Info.Técnica Technical Info Info Technique Technische Info.
				

Muebles | Furniture | Meubles | Meubels

Making

	PAGE 161 Sistema Modular Modular System Système d'installation Montagesysteem	PAGE 163 Imágenes Images Images Afbeeldingen	PAGE 198 Info.Técnica Technical Info Info Technique Technische Info.
			

Intouch

	PAGE 200 Diseño Singular Singular design Design singulière Apart Ontwerp	PAGE 202 Imágenes Images Images Afbeeldingen	PAGE 228 Info.Técnica Technical Info Info Technique Technische Info.
			

Vivaldi

	PAGE 230 Imágenes Images Images Afbeeldingen	PAGE 242 Info.Técnica Technical Info Info Technique Technische Info.
		



Paneles para alicatar | Wall panels | Panneaux d'habillage | Wandpanelen

**Skin
Panels**

	PAGE 118 Colocación sobre baldosa Fitting on tiles Installation sur carrelage Montage op tegels	PAGE 124 Colocación sobre pared Fitting on the wall Installation sur mur Montage op wand	PAGE 126 Cambio de bañera por ducha Changing a bathtub for a shower Remplacement de baignoire par une douche Vervanging van een bad door een douche	PAGE 128 Conjuntados con platos de ducha Matched with shower trays Assortis avec le receveurs de douche Met bijpassende douchebak	PAGE 114 Imágenes Images Images Afbeeldingen	PAGE 130 Info.Técnica Technical Info Info Technique Technische Info.
						

Lavabos & Consolas | Wash basins & Consoles | Vasques & Consoles | Wastafels & Consoles

Fontana

	PAGE 250 Consolas Rectas Straight Consoles Consoles Droites Rechte Consoles	PAGE 251 Consolas Curvas Curved Consoles Consoles Courbes Gebogen Consoles	PAGE 252 Lavabos sobremesa Table top wash basins Vasques à poser Wastafels opbouwmodel	PAGE 254 Textura unificada con mueble Texture unified with furniture Texture unifiée au meuble Textuur uniform met meubel	PAGE 244 Imágenes Images Images Afbeeldingen	PAGE 268 Info.Técnica Technical Info Info Technique Technische Info.
						



Platos de Ducha

Shower Trays | Receveurs de Douche | Douchebakken

PRIVILEGE - SILEX - AVANT - ELAX - ESSENTIAL

Calidad Garantizada

Quality guaranteed | Garantie de qualité | Gegarandeerde Kwaliteit



Silexpol®

Fruto de un proceso de investigación, Silexpol es la materia de los platos de ducha. Siguiendo procesos registrados de máxima sostenibilidad, el Silexpol, ofrece ventajas como la durabilidad, fácil limpieza, etc.

The result of a research process, Silexpol is the material the shower trays are made of. Following highly sustainable, registered processes, Silexpol offers advantages such as durability, easy cleaning, etc.

Fruit d'un processus de recherche, Silexpol est la matière des Receveurs de Douche. Respectant des procédures confirmées et maximales de développement durable, le Silexpol offre de nombreux avantages comme la durabilité, un nettoyage facile, etc.

Silexpol, resultaat van een onderzoeksproces, is het materiaal van de douchebakken. Silexpol volgt gepatenteerde processen die een optimale levensduur garanderen en biedt voordelen zoals duurzaamheid, eenvoudig onderhoud, enz.

Silexpol es una resina patentada por Fiora. El material altamente resistente compuesto por una mezcla homogénea de sílices y cuarzos conglomerados con un polímero.

Silexpol is a resin patented by Fiora. The highly resistant material is made of a homogeneous mixture of silicas and quartzes conglomerated with a polymere.

Le Silexpol est une résine brevetée par Fiora. Il s'agit d'un matériau hautement résistant composé d'un mélange homogène de silices et de quartz agglomérés par un polymère.

Silexpol is door Fiora gepatenteerde hars. Het uiterst resistente materiaal bestaat uit een homogeen mengsel van kiezelstenen en kwarts, samengeperst met een polymeer.

Producto antideslizante que apenas se ensucia ópticamente, con una densidad de 1.900kg/m³ y un coeficiente de absorción de 0,01%.

It is a non-slip product that barely interferes with optical aesthetics, with a density of 1.900 kg/m³ and an absorption coefficient of 0.01%.

C'est un produit antidérapant qui ne se salit pratiquement pas visuellement, avec une densité de 1 900 kg/m³ et un coefficient d'absorption de 0,01 %.

Het is een anti-slip product dat alleen optisch vuil wordt en een dichtheid heeft van 1.900 kg/m³ en een absorptiecoëfficiënt van 0,01 %.

La resistencia al impacto es similar a la de las piedras naturales, y tiene una buena resistencia a la flexión, lo que impide roturas.

Its impact resistance is similar to that of natural stone, and it is also very resistant to bending, which prevents breakages.

La résistance à l'impact est similaire à celle des pierres naturelles. Il présente en outre une bonne résistance à la flexion, ce qui empêche les ruptures.

De impactbestendigheid is vergelijkbaar met die van natuursteen, en het is bovendien goed bestendig tegen doorbuigen, wat scheuren voorkomt.

Nanobath®

Sistema bacteriostático y fungistático
Bacteriostatic and fungistatic system
Système bactériostatique et fongistatique
Bacterieremmend en schimmelwerend systeem



> Evitar la aparición de cultivos de hongos y bacterias
Avoid the appearance of fungal and bacterial cultures
Évite l'apparition de cultures fongiques et bactériennes
Het optreden van schimmels en bacteriën voorkomen



> Disminuir la aparición de manchas superficiales
Reduce the appearance of surface stains
Réduit l'apparition de taches en surface
Het ontstaan van oppervlaktevlekken beperken



> Que las propiedades antibacterianas prevalezcan
Prevalence of antibacterial properties
Privilégie les propriétés antibactériennes
Dat de antibacteriële eigenschappen voorrang hebben



Con material NANOBATH
With NANOBATH material
Comporte le matériau NANOBATH
Met NANOBATH materiaal

Sin material NANOBATH
Without NANOBATH material
Ne comporte pas le matériau NANOBATH
Zonder NANOBATH materiaal

Metalface®

Sistema de endurecimiento del material
Material hardening system
Système de durcissement du matériau
Verhardingssysteem van het materiaal



> Resistencia extrema a los golpes
Extreme resistance to impacts
Résistance extrême aux chocs
Extreme schokbestendigheid



> Máxima durabilidad del producto
Maximum durability of the product
Durabilité maximale du produit
Optimale duurzaamheid van het product



> Sin necesidad de mantenimiento
Without the need for maintenance
Ne requiert aucun entretien
Zonder noodzaak van onderhoud

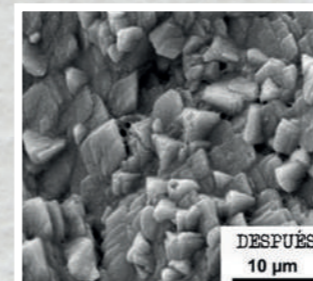

Porosidad Metalface
Metalface pore
Porosité Metalface
Metalface porie

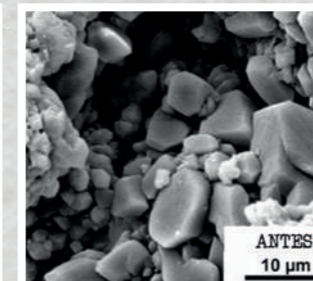

Porosidad Normal
Normal pore
Porosité Normal
Normal porie



Cambio de bañera por ducha
Changing a bathtub for a shower
Remplacement de baignoire par une douche
Vervanging van een bad door een douche

Los platos de ducha y los paneles para paredes de Fiora son la mejor solución para los cambios de bañera por ducha. por cuestiones como su instalación y su posibilidad de combinación en texturas y colores.

Fiora shower trays and wall panels are the best solution for changing a bathtub for a shower, thanks to its installation and the possibility of combining textures and colours.

Les Receveurs de Douche et les Panneaux d'habillage Fiora sont la meilleure solution en cas de remplacement de baignoire par une douche, grâce à leur mode d'installation et leur choix de coordination en textures et couleurs.

De douchebakken en de wandpanelen van Fiora zijn de beste oplossing voor het vervangen van een bad door een douche, dankzij de montage en de combinatiemogelijkheden van texturen en kleuren.



Proceso de Instalación | Installation Process | Installation | Montageproces

Ventajas
Advantages
Avantages
Voordelen



2 Paredes
 2 Walls
 2 Murs
 2 Wanden

3 Paredes
 3 Walls
 3 Murs
 3 Wanden

> Rápida Instalación
 Quick installation
 Rapidité d'installation
 Snelle Montage

> Sin juntas
 No joints
 Sans joints
 Zonder voeging

> Obra mínima
 Minimal construction work
 Moins de travaux
 Minimale werkzaamheden

> Colores&texturas unificados
 Unified colours&textures
 Couleurs&textures assorties
 Kleuren & texturen uniform



2 Paneles para paredes
 Wall panels
 Panneaux d'habillage
 Wandpanelen

2

1 Plato de Ducha
 Shower Tray
 Receveur de Douche
 Douchebak

1

Adaptabilidad

Adaptability | Adaptabilité | Aanpasbaarheid

sep system®

Soporte extensible para instalacion de platos PRIVILEGE, SILEX, AVANT, ESSENTIAL.
 Extensible support for the installation of PRIVILEGE, SILEX, AVANT, ESSENTIAL trays.
 Support extensible pour l'installation des plateaux PRIVILEGE, SILEX, AVANT, ESSENTIAL.
 Verlengbare montagesteun voor montage van douchebakken PRIVILEGE, SILEX, AVANT, ESSENTIAL.



DIN 4109

Aislamiento acústico en edificios
 Acoustic insulation in buildings
 Isolation phonique des bâtiments
 Geluidsisolatie in gebouwen

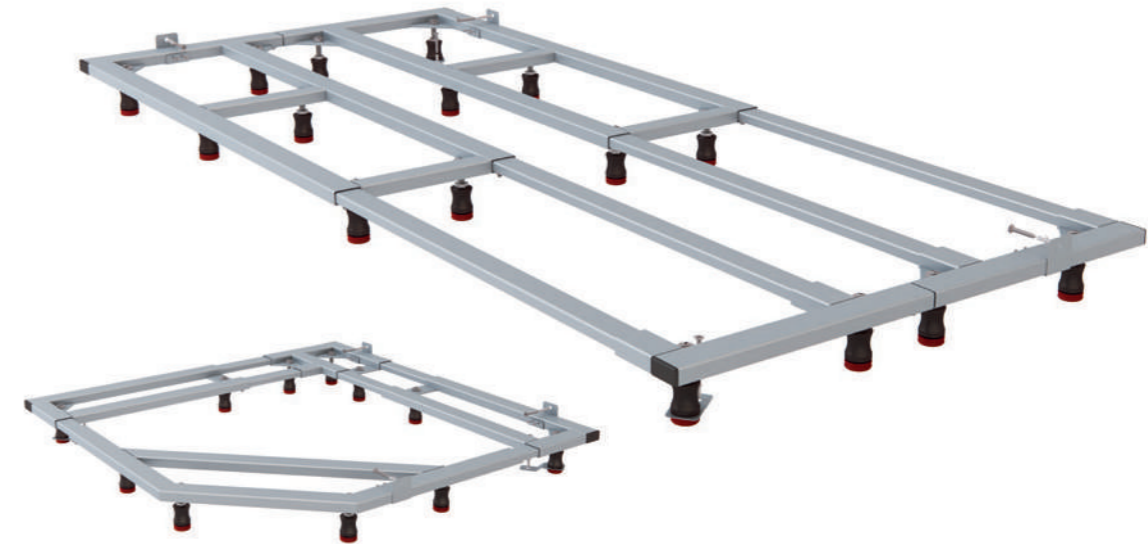

sep system® para platos angulares
 sep system® for quadrant trays
 sep system® pour plateaux d'angle
 sep system® voor hoekvormige douchebakken

sep system® para platos rectos
 sep system® for straight trays
 sep system® pour plateaux droits
 sep system® voor rechthoekige douchebakken



Patas regulables en altura
 Height-adjustable legs
 Pieds ajustables en hauteur
 In de hoogte verstelbare poten



Sistema extensible
 Extensible system
 Système extensible
 Verlengbaar systeem

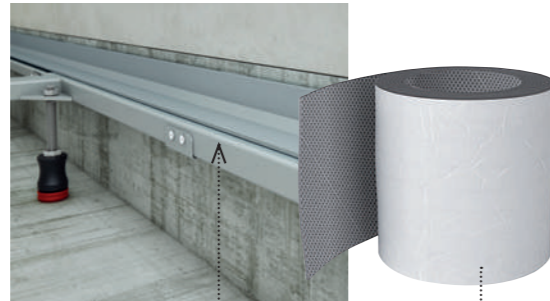

Sistema antifugas
 Anti-leak system
 Système anti-fuites
 Lekdicht systeem



Anclaje a pared
 Wall mounted
 Fixation au mur
 Muurbevestiging

VENTAJAS | ADVANTAGES | AVANTAGES | VOORDELEN

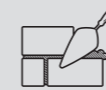

> Elimina los problemas derivados del mortero
 Eliminates the problems related to mortar
 Élimine les problèmes liés à la maçonnerie
 Voorkomt problemen die veroorzaakt worden door mortel



> Rápida Instalación
 Quick installation
 Rapidité d'installation
 Snelle Montage



> En caso de fuga o error permite rehacer la instalación
 In the event of a leak the installation can be re-done
 Permet de refaire facilement l'installation en cas de fuites ou d'erreurs
 In geval van een lek of een fout kan de montage overgedaan worden



> Aisla el ruido
 Insulates noise
 Isole du bruit
 Isoleert het geluid

Accesibilidad



Accessibility | Accessibilité | Toegankelijkheid

accessible system®

Duchas preparadas para discapacitados
Showers prepared for disabled people
Douches adaptées aux handicapés
Douches geschikt voor gehandicapten

Rampa de acceso | Access ramp
Rampe d'accès | Oprijplaat

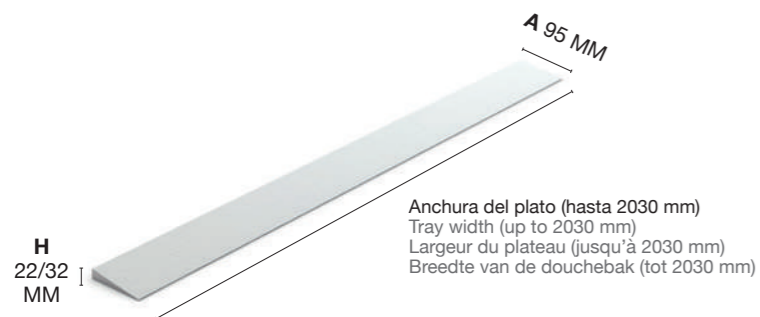

Detalle de rampa de acceso
Detail of access ramp
Détail de rampe d'accès
Detail van de oprijplaat



Privilege

Platos de Ducha | Shower Tray | Receveurs de Douche | Douchebakken

Extraplano
Extra flat
Extra-plat
Extra vlak

Enmarcado a medida
Framed to measure
Avec cadre sur mesure
Omlijst op maat

Información Técnica
Technical Information
Informations Techniques
Technische Informatie

P.
38, 39, 40, 41, 42,
43, 44, 45

P.
38, 39, 46, 47,
48, 49

P.
50, 51

Privilege

Platos de Ducha | Shower Trays | Receveurs de Douche | Douchebakken

Extraplano y Enmarcado a medida

Extra flat and
Framed to measure

Extra-plat et
avec Cadre sur mesure

Extra vlak en Omlijst
op maat

PRIVILEGE
Extraplano
Extra flat
Extra-plat
Extra vlak
Liso
OP Blanco Total



PRIVILEGE
Enmarcado a medida
Framed to measure
Avec cadre sur mesure
Omlijst op maat
Liso
OP Blanco Total



Privilege

Platos de Ducha | Shower Trays | Receveurs de Douche | Douchebakken

3 Texturas: Pizarra, Liso, Bricks.

3 Textures:
Pizarra, Liso, Bricks.

3 Textures:
Pizarra, Liso, Bricks.

3 Texturen:
Pizarra, Liso, Bricks.



PIZARRA



LISO

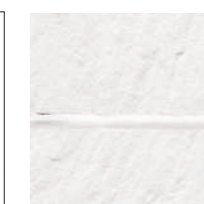

BRICKS

Privilege

Platos de Ducha | Shower Trays | Receveurs de Douche | Douchebakken

Colores sólidos
y nature que
ofrecen más de
60 posibilidades.

Solid and nature colours
that offer more than 60
possibilities.

Couleurs Uniformes et
nature offrant plus de 60
possibilités.

Solide en nature kleuren
die meer dan 60
mogelijkheden bieden.

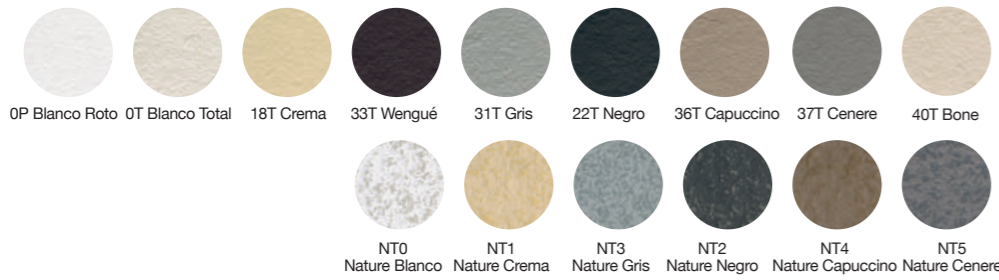

Colores personalizados RAL
RAL custom colours
Couleurs personnalisées RAL
Gepersonaliseerde RAL-kleuren

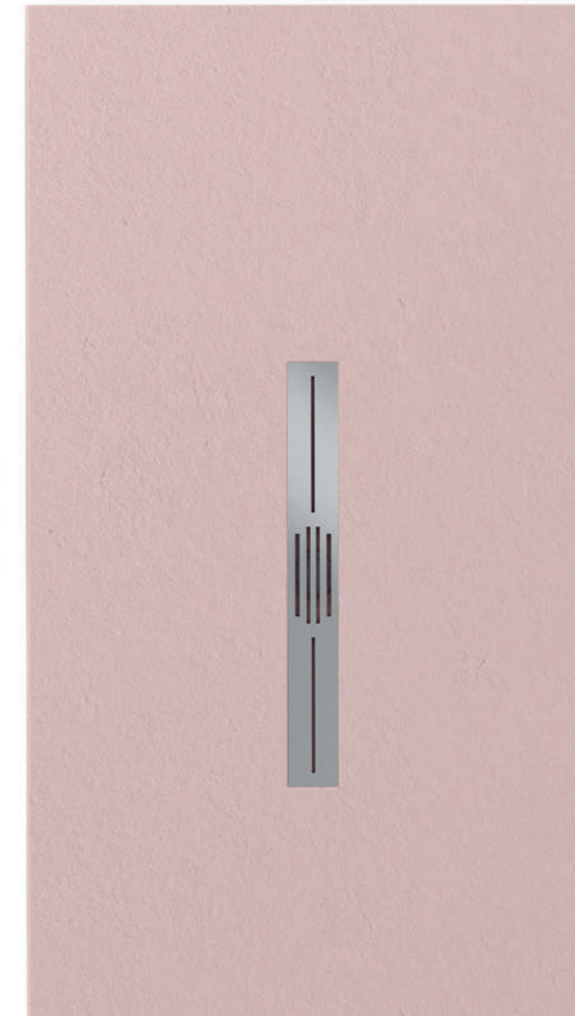

Color of
the year
2016



ROSA CUARZO
PANTONE® 13-520

Privilege - Extraplano -

Extra flat | Extra-plat | Extra vlak



Fabricación a medida
Made to measure
Fabrication sur mesure
Vervaardiging op maat

L 1000/1200/1400/1600/1800/2000 MM

Otros ejemplos | Exemples | Autres exemples | Andere voorbeelden



Rejilla Lacada en blanco
White lacquered grate
Grille Laquée en blanc
Wit gelakt rooster



Adaptable a la arquitectura
Adaptable to architecture
Adaptable aux différentes configurations
Aanpasbaar aan de opbouw



Privilege - Enmarcado a medida -

Framed to measure | Avec cadre sur mesure | Omlijst op maat

P
700
750
800
900
1000
1100
MM



L 1000/1200/1400/1600/1800/2000 MM

Adaptable a arquitecturas
Architectural adaptability
Adaptable aux différentes configurations
Aanpasbaar aan de opbouw

Fabricación a medida
Made to measure
Fabrication sur mesure
Vervaardiging op maat

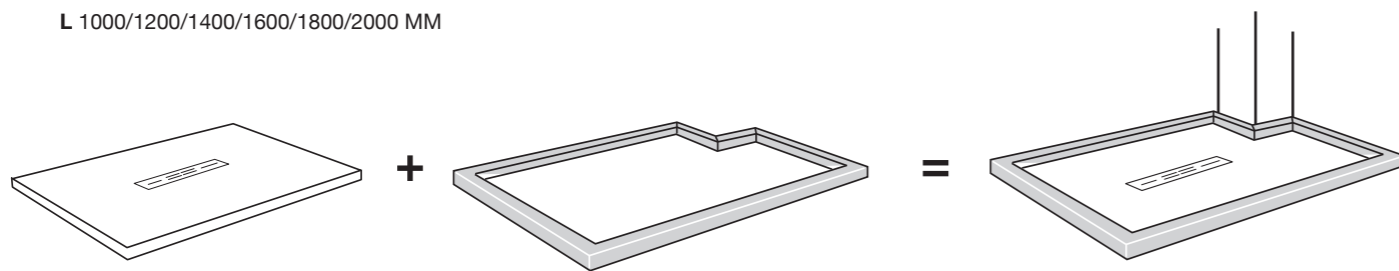

Plato
Tray
Plateau
Douchebak

Marco
Frame
Cadre
Omlijsting

Enmarcado a Medida
Framed to measure
Avec cadre sur Mesure
Omlijsting op maat

Otros ejemplos | Examples | Exemples | Andere voorbeelden



Plato de ducha enmarcado Bricks Negro
Framed shower tray Bricks Negro
Receveur de Douche avec cadre Bricks Negro
Omlijste douchebak Bricks Negro



Plato de ducha enmarcado a medida Pizarra Cenere
Framed shower tray Pizarra Cenere
Receveur de Douche avec cadre sur mesure Pizarra Ce-
nere
Douchebak omlijst op maat Pizarra Cenere





Cambio de bañera por ducha
 Changing a bathtub for a shower
 Remplacement de baignoire par une douche
 Vervanging van een bad door een douche



Privilege + Skin =

Paneles para paredes
 Wall panels
 Panneaux d'habillage
 Wandpanelen

2

Plato de Ducha
 Shower Tray
 Receveur de Douche
 Douchebak

1

PROCESO DEL CAMBIO | Changing process | Étapes de l'installation | Vervangingsprocedure



Otros ejemplos | Other examples | Autres exemples | Andere voorbeelden



Plato de ducha enmarcado liso negro con paneles Skin
 Framed shower tray liso negro with Skin panels
 Receveur de Douche liso negro avec cadre et panneaux Skin
 Omlijste douchebak met Skin panelen



Box Fiora con paneles a 3 paredes
 Box Fiora with panels on 3 walls
 Box Fiora avec panneaux sur 3 murs
 Box Fiora met panelen op 3 wanden



Privilege

Información Técnica | Technical Information | Informations Techniques | Technische Informatie

EXTRAPLANO | EXTRA FLAT | EXTRA-PLAT | EXTRA VLAK

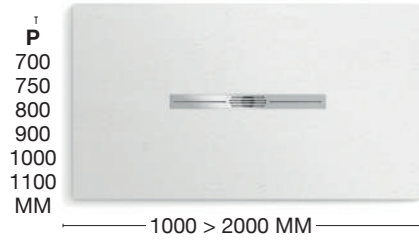

P 700/750/800/900/1000/1100
L 1000/1200/1400/1600/1800/2000
*** OPTION ***
Fabricación a medida
Made to measure
Fabriqué sur mesure
Vervaardiging op maat

ENMARCADO | FRAMED | CADRE | OMLIJST

A medida | Made-to-measure | Sur mesure | Op maat

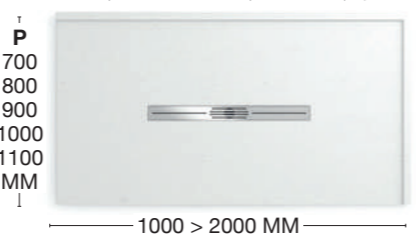

A 700/750/800/900/1000/1100
L 1000/1200/1400/1600/1800/2000
*** OPTION ***
Fabricación a medida
Made to measure
Fabriqué sur mesure
Vervaardiging op maat

Canal para mamparas | Channel for partitions | Rainure pour cloisons | Kanaal voor douchewanden



Adaptable a arquitecturas | Architectural adaptability | Adaptable aux différentes configurations | Aanpasbaar aan de opbouw

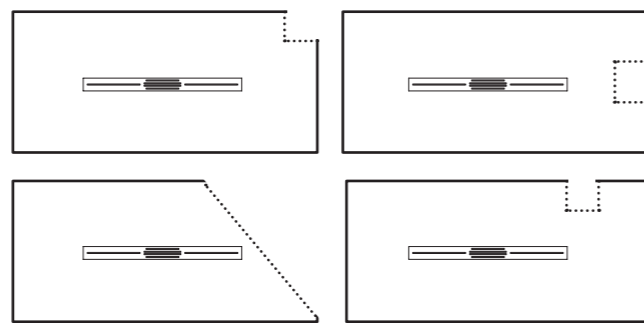

Rejilla | Grate | Grille | Rooster

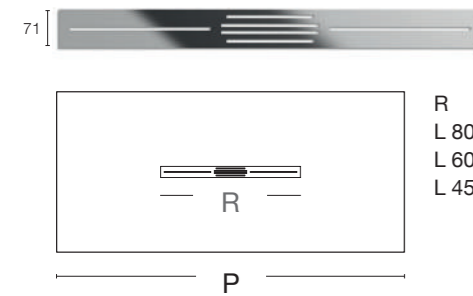

R P
L 800 > 1000/1200
L 600 > 1400/1600
L 450 > 1800/2000

Lacada | Lacquered | Laquée | Gelakt

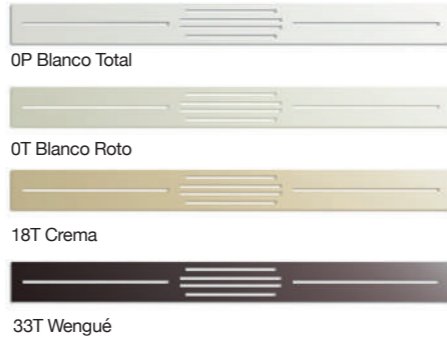

0P Blanco Total
0T Blanco Roto
18T Crema
33T Wengué

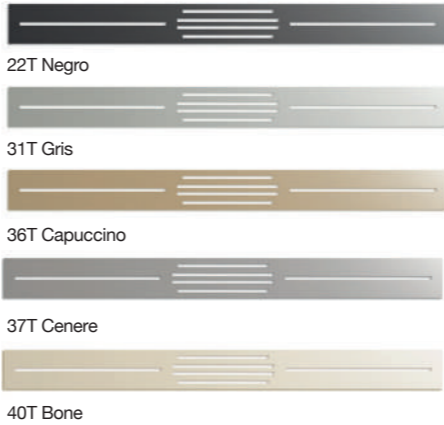

22T Negro
31T Gris
36T Capuccino
37T Cenere
40T Bone

Sifons | Wastes | Siphons | Sifons

SIFÓN D52

Salida horizontal
Horizontal outlet
Sortie horizontale
Horizontale uitgang



*** Sifón enviado por defecto**
Waste fitted by default
Siphon fourni par défaut
Standaard gemonteerde sifon

SIFÓN D52 VERTICAL

Salida vertical
Vertical outlet
Sortie verticale
Verticale uitgang



*** Opcional**
Optional
En option
Optioneel

Texturas & Colores | Textures & Colours | Textures & Couleurs | Texturen & Kleuren

PIZARRA

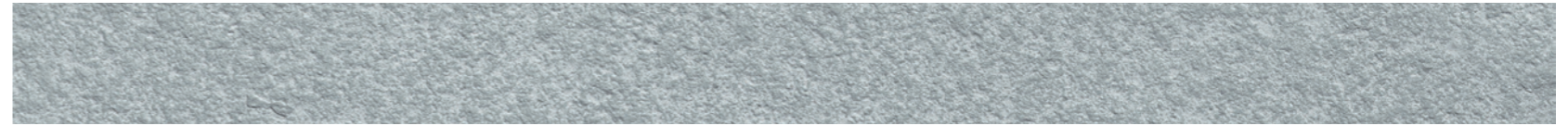

Colores Sólidos | Solid Colours | Couleurs Uniformes | Solide Kleuren



0T Blanco Roto 0P Blanco Total 18T Crema 33T Wengué 31T Gris 22T Negro 36T Capuccino 37T Cenere 40T Bone

Colores Nature | Nature Colours | Couleurs Nature | Nature Kleuren



NT0 Nature Blanco NT1 Nature Crema NT2 Nature Negro NT3 Nature Gris NT4 Nature Capuccino NT5 Nature Cenere

BRICKS



Colores Sólidos | Solid Colours | Couleurs Uniformes | Solide Kleuren



0T Blanco Roto 0P Blanco Total 18T Crema 33T Wengué 31T Gris 22T Negro 36T Capuccino 37T Cenere 40T Bone

Colores Nature | Nature Colours | Couleurs Nature | Nature Kleuren

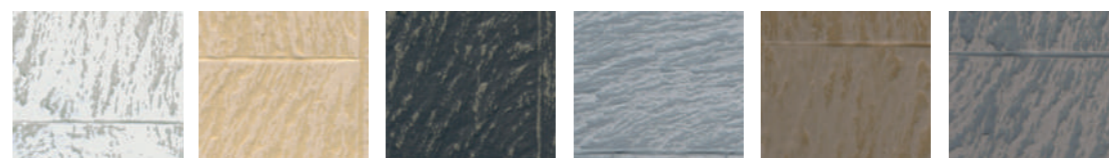

NT0 Nature Blanco NT1 Nature Crema NT2 Nature Negro NT3 Nature Gris NT4 Nature Capuccino NT5 Nature Cenere

LISO



0T Blanco Roto 0P Blanco Total 18T Crema 33T Wengué 31T Gris 22T Negro 36T Capuccino 37T Cenere 40T Bone

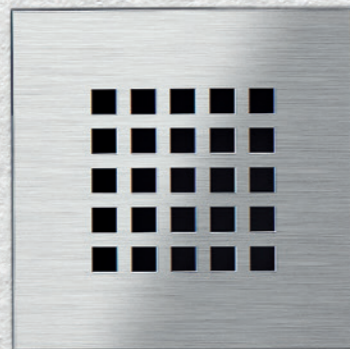

Silex

Platos de Ducha | Shower Trays | Receveurs de Douche | Douchebakken

Extraplano Extra flat Extra-plat Extra vlak	Enmarcado Framed Cadré Omlijst	Enmarcado a medida Framed to measure. Cadré sur mesure Omlijst op maat	Angular Angular D'Angle Hoekvormige	Mixto Mixto Mixto Mixto	Información Técnica Technical Information Information Technique Technical Informatie
P. 54, 55, 56, 57, 58, 59, 60, 61, 68, 69	P. 54, 55, 62, 63	P. 54, 55, 64, 65	P. 60, 61, 62, 63	P. 54, 55, 66, 67	P. 70, 71

Silex

Platos de Ducha | Shower Trays |
Receveurs de Douche | Douche-
bakken

Extraplano
Enmarcado
Enmarcado
a medida
Mixto

Extra flat
Framed
Framed to measure
Mixto

Extra-plat
Avec cadre
Avec cadre sur mesure
Mixto

Extra vlak
Omlijst
Omlijst op maat
Mixto



Enmarcado a medida
Framed to measure
Avec cadre sur mesure
Omlijst op maat



Mixto
Mixto
Mixto
Mixto



Enmarcado
Framed
Avec cadre
Omlijst



Extraplano
Extra flat
Extra-plat
Extra vlak

Platos de Ducha | Shower Trays |
Receveurs de Douche | Douchebakken

2 Texturas: Pizarra, Liso.

2 Textures:
Pizarra, Liso.

2 Textures:
Pizarra, Liso.

2 Texturen:
Pizarra, Liso.

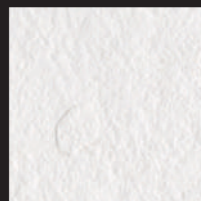

PIZARRA

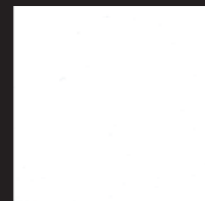

LISO

***MIXTO**
Sólo en textura Pizarra
Only in Pizarra textuta
Uniquement en Pizarra
Uitsluitend in textuur Pizarra



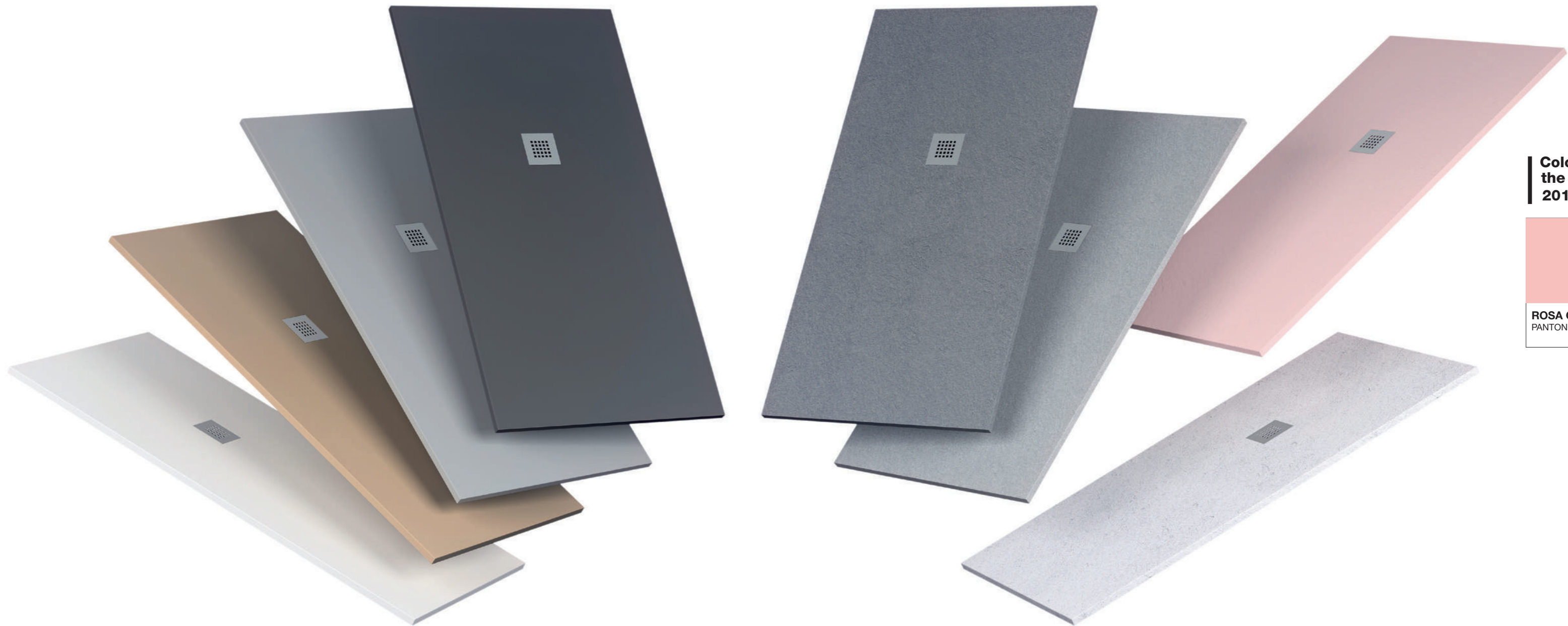

Silex

Platos de Ducha | Shower Trays | Receveurs de Douche | Douchebakken

Colores sólidos y nature
que ofrecen más de 60
posibilidades.



Colores personalizados RAL
RAL custom colours
Couleurs personnalisées RAL
Gepersonaliseerde RAL-kleuren

Solid and nature colours
that offer more than 60
possibilities.

Couleurs Uniformes et
nature offrant plus de 60
possibilités.

Solide en nature kleuren
die meer dan 60
mogelijkheden bieden.

Silex - Extraplano -

Extra flat | Extra-plat | Extra vlak

P
700
750
800
900
1000
1100
MM



L 1000/1100/1200/1400/1500/
1600/1800/2000 MM

RECTANGULAR | RECTANGULAR |
RECTANGULAIRE | RECHTHOEKIG

P
800
900
1000
MM



R 550 MM
L 800/900/1000 MM

ANGULAR | QUADRANT |
D'ANGLE | HOEKVORMIG

P
1000
MM



L 1000 MM

PENTAGONAL | PENTAGONAL |
PENTAGONAL | VIJFHOEKIG



Rejilla Inox
Stainless steel grate
Inox Grille
Rooster in roestvrij staal



Rejilla Lacada
Lacquered grate
Grille laquée
Gelakt rooster



Plato de ducha Angular
Quadrant shower tray
Receveur de Douche d'Angle
Hoekvormige Douchebak







Plato de ducha Pentagonal
Pentagonal shower tray
Receveur de Douche Pentagonal
Vijfhoekige Douchebak



Silex - Enmarcado -

Framed | Avec cadre | Halfomlijst

<p>P 700 750 800 900 MM</p>		<p>P 800 900 1000 MM</p>		<p>P 900 MM</p>		<p>P 900 MM</p>	
	<p>L 900/1000/1200/1400/1500/ 1600/1700 MM</p>		<p>L 800/900/1000 MM</p>		<p>L 1200 MM</p>		<p>L 900 MM R 504 MM</p>
	<p>RECTANGULAR RECTANGULAR RECTANGULAIRE RECHTHOEKIG</p>		<p>CUADRADO SQUARE CARRÉ VIERKANT</p>		<p>SEMI-ENMARCADO SEMI-FRAMED AVEC SEMI-CADRÉ HALFOMLIJST</p>		<p>ANGULAR QUADRANT D'ANGLE HOEKVORMIG</p>



Semienmarcado Angular
Quadrant Semi-Framed
Semi-cadre d'Angle
Halfomlijst Hoekvormig



Enmarcado Cuadrado
Square framed
Avec cadre Carré
Halfomlijst Vierkant



Silex - Enmarcado a medida -

Framed to measure | Avec cadre sur mesure | Omlijst op maat

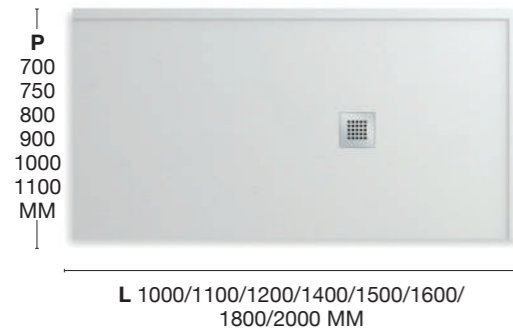

Adaptable a arquitecturas
Architectural adaptability
Adaptable aux différentes configurations
Aanpasbaar aan de opbouw

Fabricación a medida
Made to measure
Fabrication sur mesure
Vervaardiging op maat

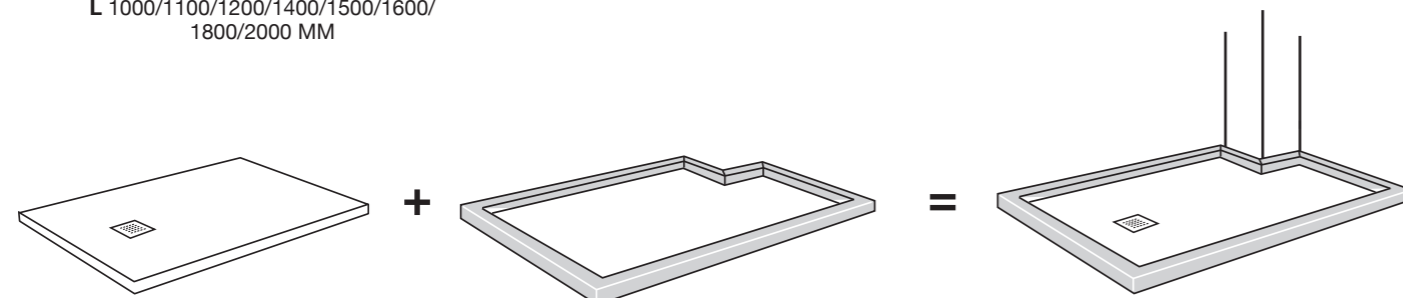

Plato
Shower tray
Plateau
Douchebak

Marco
Frame
Cadre
Omlijsting

Enmarcado a Medida
Framed to measure
Avec cadre sur Mesure
Omlijst op maat



Enmarcado a medida y adaptado a arquitectura
Framed to measure and adapted to architecture
Cadre sur mesure et adapté à la configuration
Omlijst op maat en aangepast aan de opbouw



Enmarcado a medida y adaptado a arquitectura
Framed to measure and adapted to architecture
Cadre sur mesure et adapté à la configuration
Omlijst op maat en aangepast aan de opbouw



Silex Mixto

Platos de Ducha | Shower Trays | Receveurs de Douche | Douchebakken

A
800
900
MM



L 1700/2000 MM



Rejilla Inox
Stainless steel grate
Grille Inox
Rooster in roestvrij staal



Rejilla Lacada
Lacquered Grid
Grille Laquée
Gelakt rooster

MIXTO | MIXTO | MIXTO | MIXTO

A 800/900 MM
L 1700/2000 MM



Silex Mixto Pizarra Negro
Silex Mixto Pizarra Negro
Silex Mixto Pizarra Negro
Silex Mixto Pizarra Negro



Zona de secado
Drying area
Zone de séchage
Afdrogruimte





Cambio de bañera por ducha
 Changing a bathtub for a shower
 Remplacement de baignoire par une douche
 Vervanging van een bad door een douche

Silex + Skin =

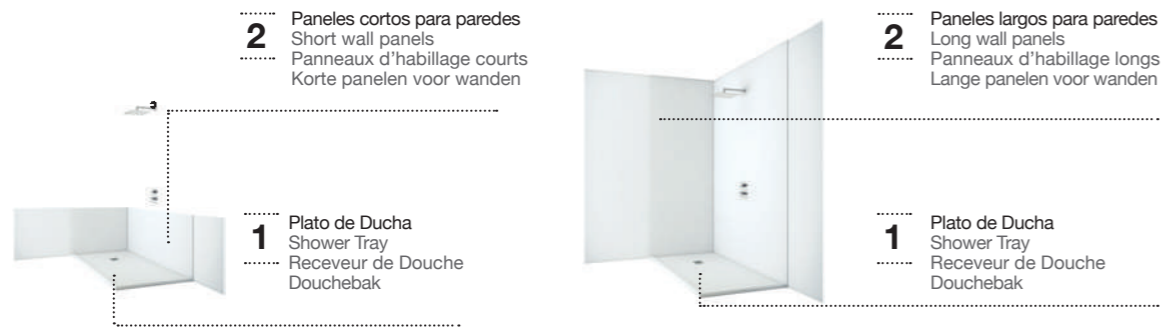

PROCESO DEL CAMBIO | Changing process | Étapes de l'installation | Vervangingsprocedure

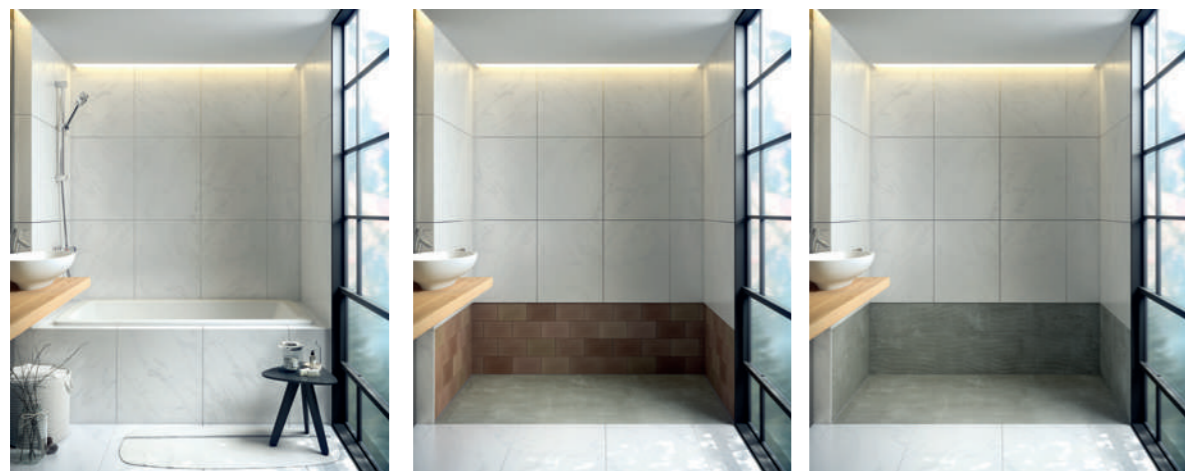

Otros ejemplos | Other examples | Autres exemples | Andere voorbeelden



Plato de ducha Enmarcado + Paneles Skin
 Framed shower tray + Skin Panels
 Receveur de Douche avec Cadre + Panneaux Skin
 Omlijste Douchebak + Skin Panelen

Plato de ducha con faldón, paneles Skin
 Shower tray with short Skin panels
 Receveur de Douche avec panneaux Skin
 Douchebak met korte Skin panelen



Silex

Información Técnica | Technical Information | Informations Techniques | Technische Informatie

EXTRAPLANO | EXTRA FLAT | EXTRA-PLAT | EXTRA VLAK

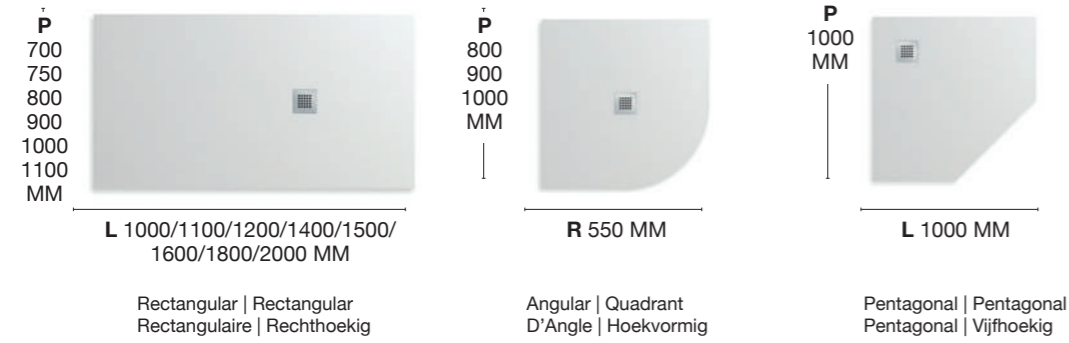

ENMARCADO | FRAMED | CADRÉ | RAHMEN

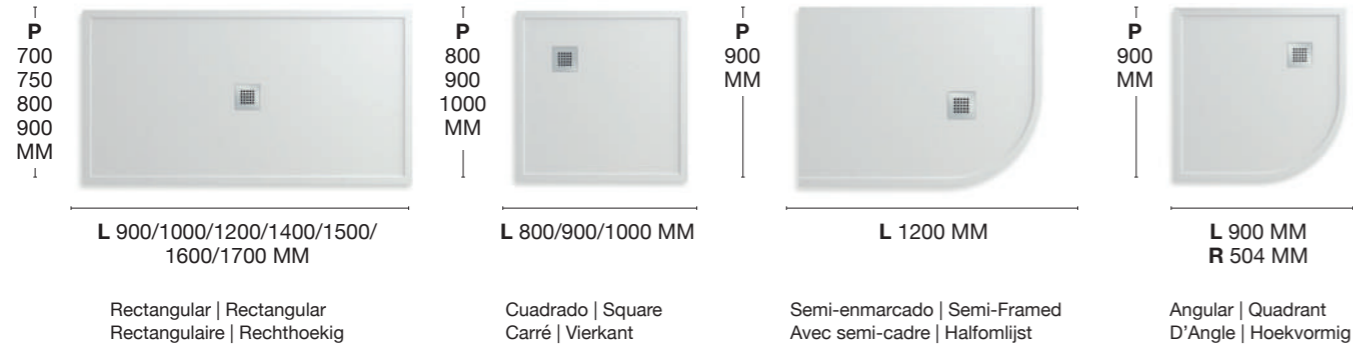

MIXTO | MIXTO | MIXTO | MIXTO



ENMARCADO A MEDIDA | FRAMED TO MEASURE AVEC CADRE SUR MESURE | OMLIJST OP MAAT

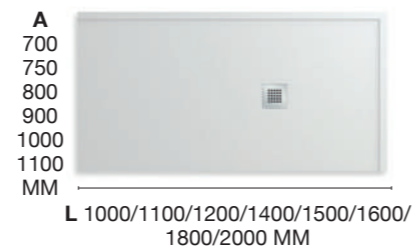

Canal para mamparas
Channel for partitions
Rainure pour cloisons
Kanaal voor douchewanden



Rejilla
Grate
Grille
Reinne



Inox
Stainless steel
Inox
Roestvrij staal

Lacada
Lacquered
Laquée
Gelakt

Adaptable a arquitecturas | Architectural adaptability | Adaptable aux différentes configurations | Aanpasbaar aan de opbouw

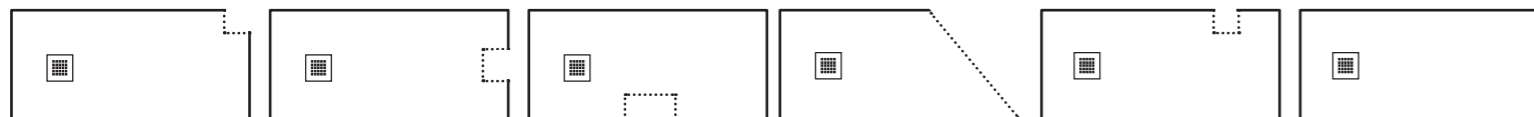

Sifón | Waste | Siphon | Sifon



**SIFÓN
(ESTÁNDAR)**

Salida horizontal
Horizontal outlet
Sortie horizontale
Horizontale uitgang

**SIFÓN
VERTICAL**

Salida vertical
Vertical outlet
Sortie verticale
Verticale uitgang

**SIFÓN
REDUCIDO**

Sifón reducido salida horizontal
Small waste horizontal outlet
Siphon raccourci sortie horizontale
Kleine sifon met horizontale uitgang

**SIFÓN
PLUS**

Plus salida horizontal
Plus horizontal outlet
Plus sortie horizontale
Plus horizontale uitgang

viega

Texturas & Colores | Textures & Colours | Textures & Couleurs | Texturen & Kleuren

PIZARRA

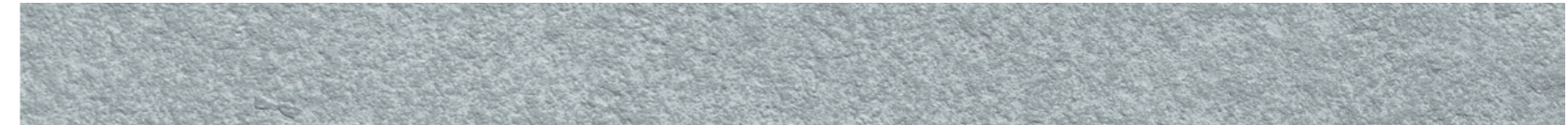

Colores Sólidos | Solid Colours | Couleurs Uniformes | Solide Kleuren



0T Blanco Roto 0P Blanco Total 18T Crema 33T Wengué 31T Gris 22T Negro 36T Capuccino 37T Cenere 40T Bone

Colores Nature | Nature Colours | Couleurs Nature | Nature Kleuren

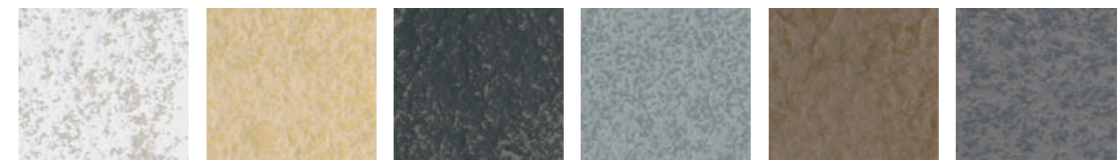

NT0 Nature Blanco NT1 Nature Crema NT2 Nature Negro NT3 Nature Gris NT4 Nature Capuccino NT5 Nature Cenere

LISO

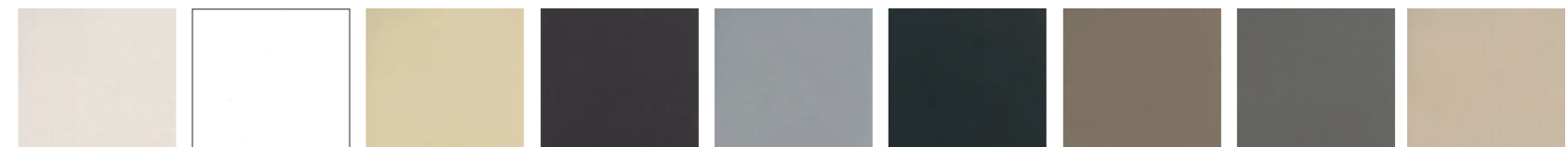

0T Blanco Roto 0P Blanco Total 18T Crema 33T Wengué 31T Gris 22T Negro 36T Capuccino 37T Cenere 40T Bone

[flora]

Avant

Platos de Ducha | Shower Trays | Receveurs de Douche | Douchebakken

Información Técnica
Technical Information
Informations Techniques
Technische Informatie

P.
82, 83

Avant

Un diseño exquisito.
Un marco rebajado con
una rejilla exclusiva.

Exquisite design Frame lowered
with a unique grate.

Un design exquis. Un cadre abaissé
avec une grille unique.

Een voortreffelijk ontwerp. Een verlaagde
omlijsting met een uniek rooster.



Avant

Platos de Ducha | Shower Trays | Receveurs de Douche | Douchebakken

1 Textura
exclusiva,
pizarra plaquetas.

1 Exclusive texture,
pizarra tiling.

1 Texture exclusive,
pizarra plaquettes.

1 exclusieve textuur,
met leistenen.



PIZARRA PLAQUETAS



Avant

Platos de Ducha | Shower Trays | Receveurs de Douche | Douchebakken

Colores Sólidos y Nature. Rejillas inox o lacadas.

Solid and Nature colours.
Stainless steel or lacquered grates.

Couleurs Uniformes et Nature.
Grilles inox ou laquées.

Solide en Nature Kleuren.
Gelakte of roestvrijstalen roosters.



0P BLANCO
Rejilla Inox
Stainless steel grate
Grille Inox
Rooster in roestvrij staal

22T NEGRO
Rejilla Inox
Stainless steel grate
Grille Inox
Rooster in roestvrij staal

31T GRIS
Rejilla Inox
Stainless steel grate
Grille Inox
Rooster in roestvrij staal

36T CAPUCCINO
Rejilla Inox
Stainless steel grate
Grille Inox
Rooster in roestvrij staal

33T WENGÉ
Rejilla lacada
Lacquered grate
Grille laquée
Gelakt rooster

18T CREMA
Rejilla Inox
Stainless steel grate
Grille Inox
Rooster in roestvrij staal

0T BLANCO ROTO
Rejilla Inox
Stainless steel grate
Grille Inox
Rooster in roestvrij staal

37T CENERE
Rejilla Inox
Stainless steel grate
Grille Inox
Rooster in roestvrij staal

Avant

Platos de Ducha | Shower Trays | Receveurs de Douche | Douchebakken

P
700
800
900
MM



Inox | Stainless steel | Inox | Roestvrij staal



Lacada | Lacquered | Laquée | Gelakt

L 1200/1300/1400/1500/1600/1700/1800 MM

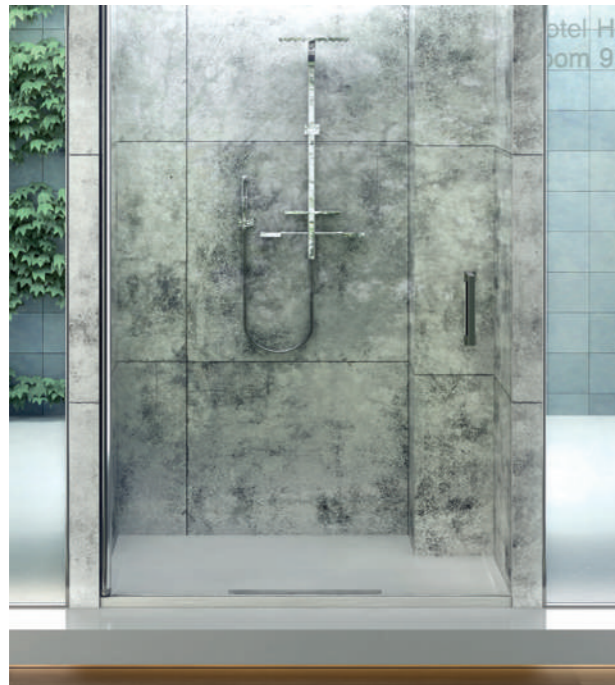

Posibilidad de adaptación a arquitecturas
Possibility of custom manufacturing
Architectural adaptability.
Possibilité de fabrication sur mesure.
Adaptable aux différentes configurations.
Maatwerk mogelijk Aanpasbaar aan de opbouw.

Rejilla Lacada blanca
White Lacquer grate
Grille Laquée en blanc
Wit gelakt rooster



Avant

Información Técnica | Technical Information | Informations Techniques | Technische Informatie

Dimensiones | Dimensions | Dimensions | Afmetingen

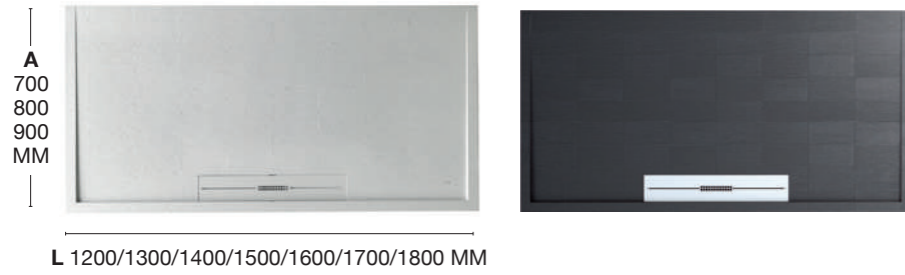

Rejilla | Grate | Grille | Rooster



Lacada | Lacquered | Laquée | Gelakt

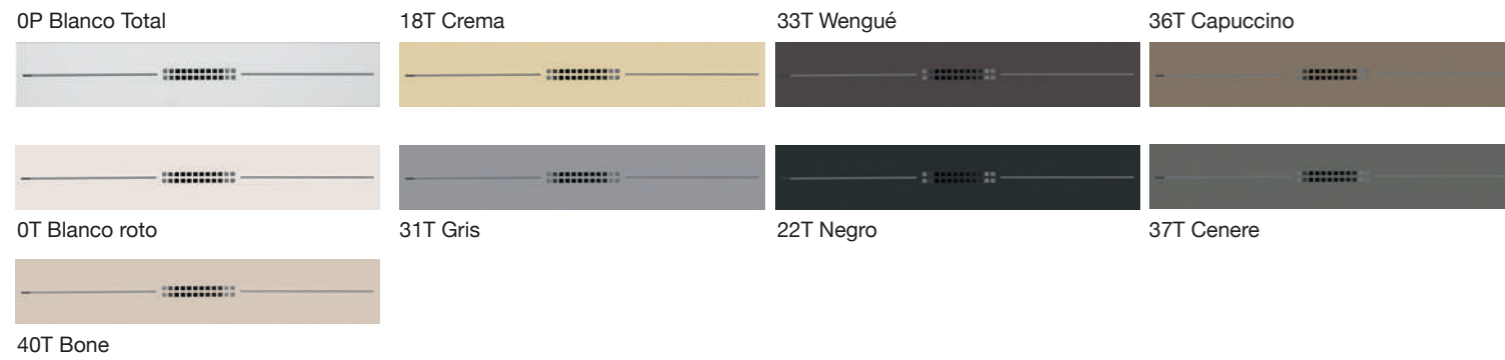

Sifón | Waste | Siphon | Sifón



SIFÓN (ESTÁNDAR)

Salida horizontal
Horizontal outlet
Sortie horizontale
Horizontale uitgang



SIFÓN VERTICAL

Salida vertical
Vertical outlet
Sortie verticale
Verticale uitgang



SIFÓN REDUCIDO

Sifón reducido salida horizontal
Small waste horizontal outlet
Siphon raccourci sortie horizontale
Kleine sifon met horizontale uitgang



SIFÓN PLUS

Plus salida horizontal
Plus horizontal outlet
Plus sortie horizontale
Plus horizontale uitgang



Texturas & Colores | Textures & Colours | Textures & Couleurs | Texturen & Kleuren

PIZARRA



Colores Sólidos | Solid Colours | Couleurs Uniformes | Solide Kleuren



Colores Nature | Nature Colours | Couleurs Nature | Nature Kleuren

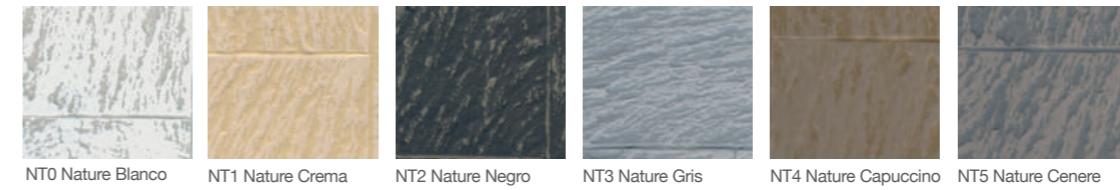

Essential



Platos de Ducha | Shower Trays | Receveurs de Douche | Douchebakken

Información Técnica
Technical Information
Informations Techniques
Technische Informatie

P.
94, 95



Essential

Platos de Ducha | Shower Trays | Receveurs de Douche | Douchebakken

El mejor precio
con la
calidad Fiora.

The best price without
losing Fiora quality.

Le meilleur prix pour la
même qualité Fiora.

De beste prijs zonder in
te boeten aan de kwaliteit
van Fiora.



Essential  Best Price

Platos de Ducha | Shower Trays | Receveurs de Douche | Douchebakken

Claves de un gran producto

The keys to a great product

L'essentiel d'un grand produit

Sleutels voor een fantastisch product



01

15 Medidas
15 Sizes
15 Dimensions
15 Afmetingen



02

Rejilla exclusiva inox
Exclusive stainless steel grate
Grille exclusive inox
Exclusief roestvrijstalen rooster



03

viega

Sifón Essential
Essential waste
Siphon Essential
Sifon Essential



04

Textura Pizarra
Pizarra Texture
Texture Pizarra
Textuur Pizarra



05

8 Colores Sólidos
8 Solid Colours
8 Couleurs Uniformes
8 Solide Kleuren

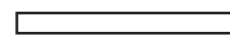

06

Extraplano
Extra flat
Extra-plat
Extra vlak



Essential

Platos de Ducha | Shower Trays | Receveurs de Douche | Douchebakken



Son fácilmente adaptables en obra.
They are easily adapted during construction.
Adaptable durant l'installation.
Ze zijn gemakkelijk aan te passen bij de installatie.

Essential 22T Pizarra Negro



Essential

fiora
BOX

Cambio de bañera por ducha
Changing a bathtub for a shower
Remplacement de baignoire par une douche
Vervanging van een bad door een douche

Essential + Skin =



2 Paneles para paredes
Wall panels
Panneaux d'habillage
Wandpanelen

1 Plato de Ducha
Shower Tray
Receveurs de Douche
Douchebak



Dimensiones | Dimensions | Dimensions | Afmetingen

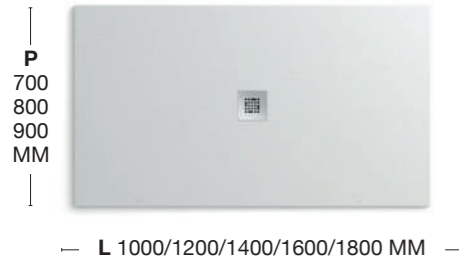

Rejilla | Grate | Grille | Rooster

SIFÓN ESSENTIAL

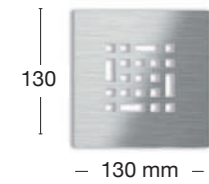

Salida horizontal
Horizontal outlet
Sortie horizontale
Horizontale uitgang

* Sifón enviado por defecto
Waste sent by default
Siphon envoyé par défaut
Levering sifon automatisch

Sifón | Waste | Siphon | Sifon



SIFÓN (ESTÁNDAR)

Salida horizontal
Horizontal outlet
Sortie horizontale
Horizontale uitgang



SIFÓN VERTICAL

Salida vertical
Vertical outlet
Sortie verticale
Verticale uitgang



SIFÓN REDUCIDO

Sifón reducido salida horizontal
Small waste horizontal outlet
Siphon raccourci sortie horizontale
Kleine sifon met horizontale uitgang



SIFÓN PLUS

Plus salida horizontal
Plus horizontal outlet
Plus sortie horizontale
Plus horizontale uitgang

- > Los platos Essential se envían siempre con el sifón Essential.
- > Hay disponibles otros 4 tipos de Sifons: estándar, vertical, reducido y plus.
- > Sifons Viega.

- > Essential trays are always sent with the Essential waste.
- > There are 4 other types of waste available: standard, vertical, reduced and plus.
- > Viega wastes

- > Les plateaux Essential sont toujours livrés avec le siphon Essential.
- > 4 types de siphons sont disponibles : standard, vertical, raccourci et plus.
- > Siphons Viega.

- > De Essential douchebakken worden steeds met de Essential sifon gestuurd.
- > Er zijn 4 andere soorten sifon verkrijgbaar: standaard, verticaal, klein en plus.
- > Sifons Viega



Texturas & Colores | Textures & Colours | Textures & Couleurs | Texturen & Kleuren

PIZARRA

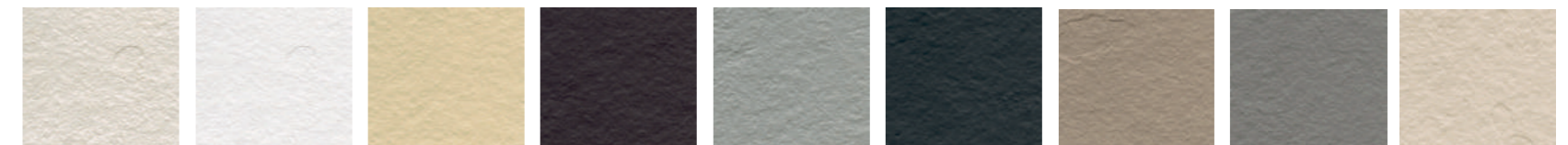

0T Blanco Roto 0P Blanco Total 18T Crema 33T Wengué 31T Gris 22T Negro 36T Capuccino 37T Cenere 40T Bone

Sistema de Embalaje "easy" | "Easy" packaging system | Système de Conditionnement « easy » | Verpakkingssysteem "easy"



"easy packaging"
Embalaje diseñado con asas para transportar el plato de ducha con facilidad
Packaging designed with handles to easily transport the shower tray
Emballage conçu avec des poignées pour transporter le Receveur de Douche facilement
Verpakking met handvatten om de douchebak comfortabel te vervoeren

Asas
Handles
Poignées
Handvaten

Elax **Elaxpol®**

Platos de Ducha | Shower Trays | Receveurs de Douche | Douchebakken

Tea System
Tea System
Tea System
Tea System

Classic System
Classic System
Classic System
Classic System

Información Técnica
Technical Information
Informations Techniques
Technische Informatie

P.
100, 101, 102,
103, 106, 107,
108, 109

P.
102, 103, 104,
105, 110, 111

P.
112, 113

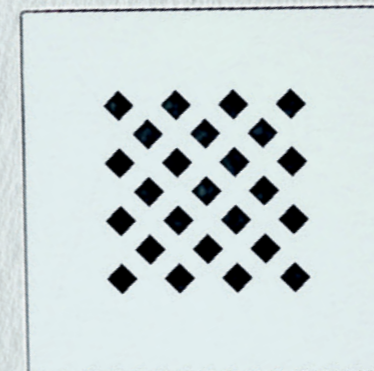

Elax

Elaxpol®

Sólo ventajas respecto a los platos de obra convencionales.

Just advantages with respect to conventional shower trays.

Que des avantages par rapport aux Receveurs de Douche maçonnés classiques.

Alleen maar voordelen in vergelijking met de conventionele douchebakken.



01

Adaptabilidad total
Total adaptability
Adaptabilité totale
Totale aanpasbaarheid



02

Fácil instalación
Easy installation
Facilité d'installation
Eenvoudige montage



03

Peso reducido
Reduced weight
Poids réduit
Gering gewicht

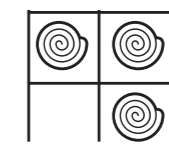

04

Fácil de almacenar
Easy storage
Stockage facile
Kan gemakkelijk worden opgeslagen



05

Antideslizante
Anti-slip
Antidérapant
Antislip



06

Tacto confortable
Comfortable feel
Toucher confortable
Voelt comfortabel aan

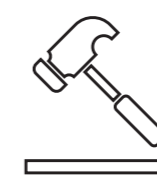

07

Resistente a golpes
Shock resistant
Résistant aux coups
Schokbestendig



08

Sin juntas
No joints
Sans joints
Zonder voeging



09

Sin impermeabilización
Without waterproofing
Sans imperméabilisation
Zonder waterdichting



10

Antibacteriano
Antibacterial
Antibacterien
Antibacteriële behandeling

Elax

Platos de Ducha | Shower Trays | Receveurs de Douche | Douchebakken

Elaxpol®

100% Adaptable.
100% Flexible
Perfecto para
la ducha de obra.

100% Adaptable.
100% Flexible
Perfect for the
refurbished shower.

100 % Adaptable.
100 % Souple
Parfait pour une douche
maçonnée.

100% Aanpasbaar.
100% Flexibel
Perfect voor de
gebouwde douche.

Elax

Platos de Ducha | Shower Trays | Receveurs de Douche | Douchebakken

2 Sistemas de evacuación: con canaleta TEA System[®], con rejilla CLASSIC System[®]

2 evacuation systems:
with TEA System[®] linear
drain, with CLASSIC
System[®] grate

2 Systèmes d'évacuation :
avec Caniveau TEA System[®],
avec grille CLASSIC System[®]

2 Afvoersystemen:
met douchegoot TEA
System[®], met rooster
CLASSIC System[®]



TEA System[®]
Canaleta
Linear drain
Caniveau
Douchegoot



CLASSIC System[®]
Rejilla
Grate
Grille
Rooster

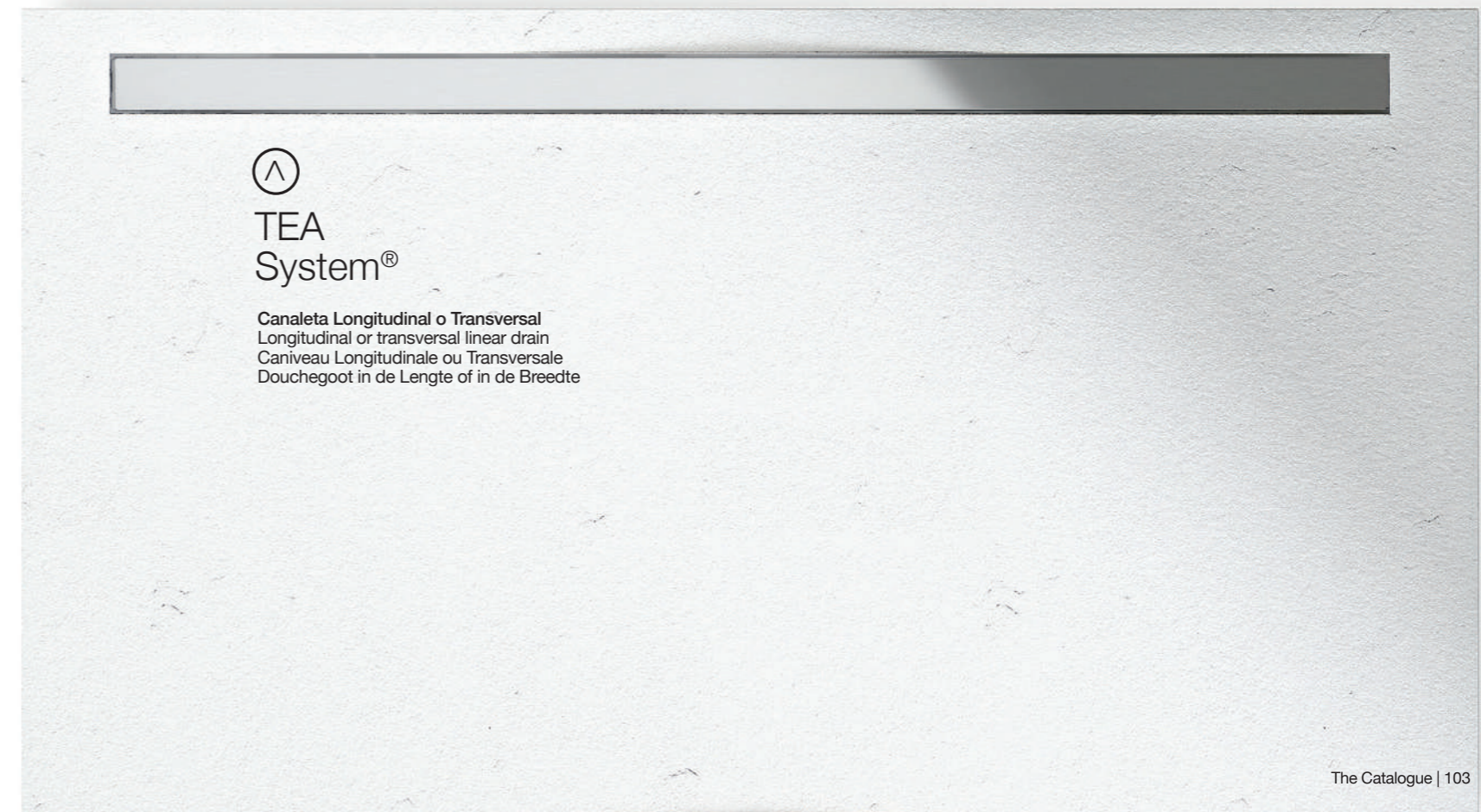
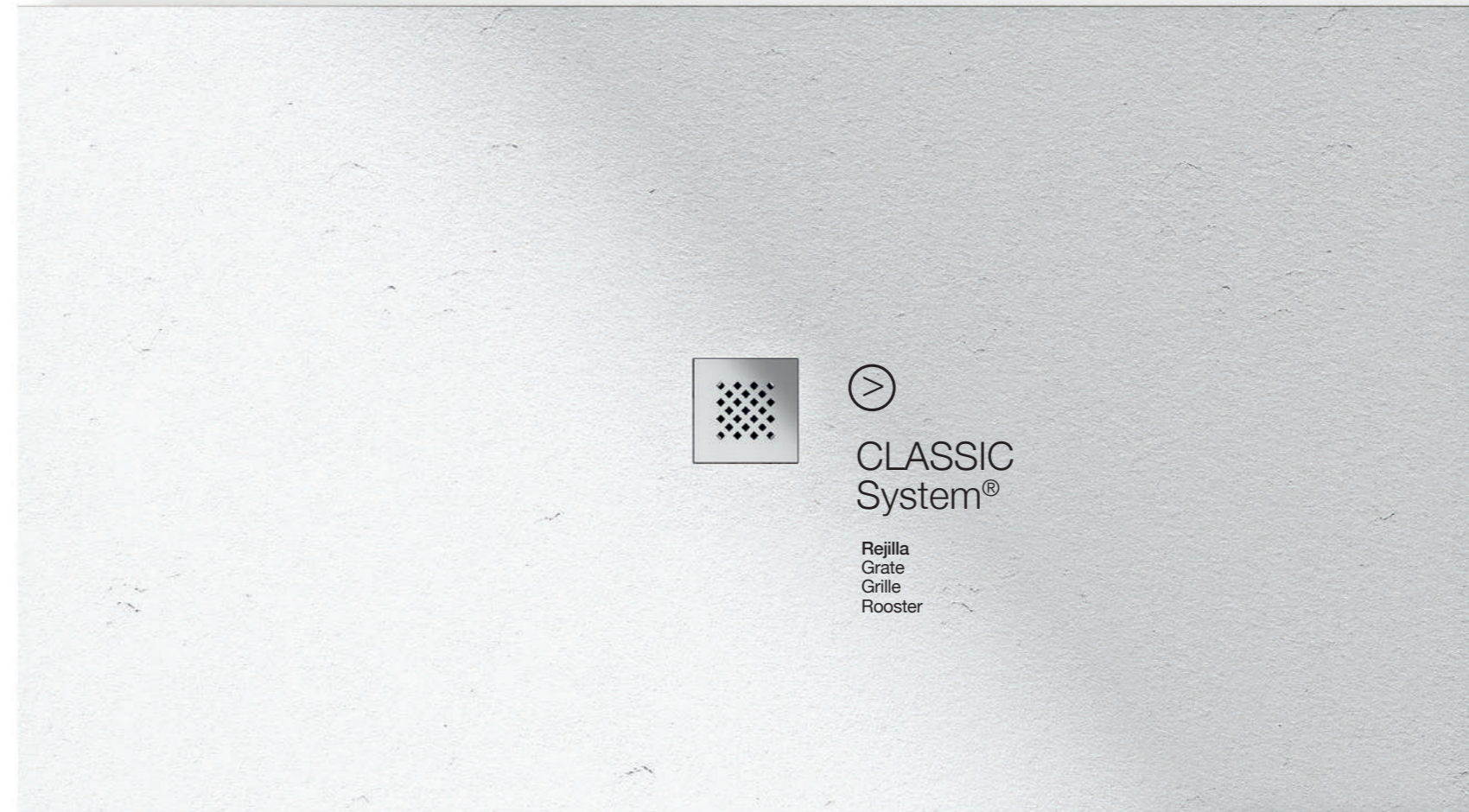

Elax

Platos de Ducha | Shower Trays | Receveurs de Douche | Piatti Doccia | Douchebakken

Textura Pizarra en colores sólidos.

Pizarra texture
in solid colours.

Texture Pizarra
en Couleurs Uniformes.

Textuur Pizarra
in solide kleuren.

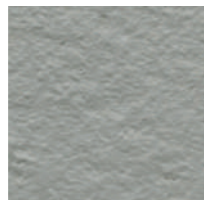

PIZARRA

Elax - Canaleta longitudinal -

Longitudinal linear drain | Caniveau longitudinale | Douchegoot in de lengte

P
700
800
900
1000
1100
1200
MM



Inox | Stainless steel | Inox | Roestvrij staal



Elaxpol®



L 1000/1200/1400/1600/1800/2000/2250/2500 MM



Canaleta Inox
Stainless steel linear drain
Caniveau Inox
Roestvrijstalen douchegoot

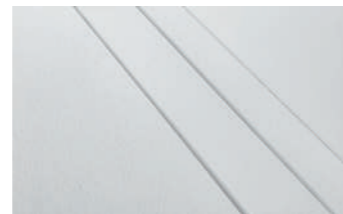

Canaleta Elaxpol®
Elaxpol® linear drain
Caniveau Elaxpol®
Elaxpol® douchegoot

Elax con canaleta en acabado Elaxpol®
Elax with linear drain in Elaxpol® finish
Elax avec caniveau en finition Elaxpol®
Elax met douchegoot met Elaxpol® afwerking



Elax - Canaletta transversal -

Transversal linear drain | Caniveau transversale | Douchegoot in de breedte

P
700
800
900
1000
1100
1200
MM



Inox | Stainless steel | Inox | Roestvrij staal

Elaxpol®

TEA System®

L 1000/1200/1400/1600/1800/2000/2250/2500 MM



Canaleta transversal inox
Stainless steel transversal linear drain
Caniveau transversale inox
Roestvrijstalen douchegoot in de breedte



Canaleta transversal Elaxpol®
Elaxpol® transversal linear drain
Caniveau transversale Elaxpol®
Elaxpol® douchegoot in de breedte



Elax - Rejilla -

Grate | Grille | Rooster

P
700
800
900
1000
1100
1200
MM



Rejilla Inox
Stainless steel grate
Grille Inox
Rooster in roestvrij staal

CLASSIC System®

L 1000/1200/1400/1600/1800/2000/2250/2500 MM



Formas irregulares Pizarra Gris
Irregular shapes Pizarra Gris
Formes irrégulières Pizarra Gris
Onregelmatige vormen Pizarra Gris



Formas circulares Pizarra Negro
Circular shapes Pizarra Negro
Formes circulaires Pizarra Negro
Ronde vormen Pizarra Negro





TEA System®

Canaleta | Linear drain | Conduite d'écoulement | Douchegoot

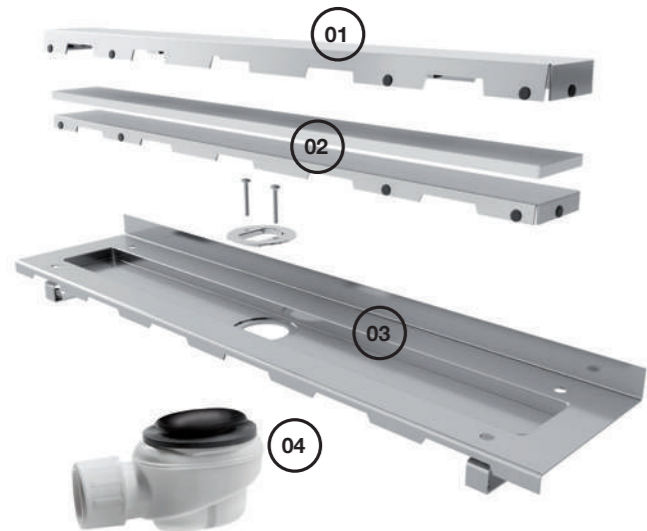

Inox | Stainless steel | Inox | Roestvrij staal

Elaxpol®



Canaleta en inox o Silexpol® y en longitudinal o transversal
Linear drain in stainless steel or Silexpol® and longitudinal or transversal
Caniveau en inox ou Silexpol® et longitudinale ou transversale
Roestvrijstalen of Silexpol® douchegoot® in de lengte of in de breedte

- | | | | |
|---|---|--|--|
| 01. Embellecedor Elaxpol
Elaxpol trim
Enjoliveur Elaxpol
Sierrand Elaxpol | 02. Embellecedor inox
Stainless steel trim
Enjoliveur inox
Roestvrijstalen sierrand | 03. Canaleta
Linear drain
Conduite d'écoulement
Douchegoot | 04. Sifón
Waste
Siphon
Sifon |
|---|---|--|--|



CLASSIC System®

Sifón | Siphon | Siphon | Sifon



CLASSIC SYSTEM 02

Sifón salida horizontal
Small waste horizontal outlet
Siphon sortie horizontale
Sifon met horizontale uitgang

Rejilla | Grate | Grille | Reinne



Rejilla Inox
Stainless steel grate
Grille Inox
Rooster in roestvrij staal

Sección sifón interior
Interior section waste
Section intérieure du siphon
Doorsnede binnenkant sifon



- 01.** Sección canaleta
Linear drain section
Section de la conduite d'écoulement
Doorsnede douchegoot
- 02.** Canaleta con 1 desagüe
Linear drain with 1 drain
Caniveau 1 évacuation
Douchegoot met 1 afvoer
- 03.** Canaleta con 2 desagües
Linear drain with 2 drains
Caniveau 2 évacuations
Douchegoot met 2 afvoeren

Texturas & Colores | Textures & Colours | Textures & Couleurs | Texturen & Kleuren

PIZARRA

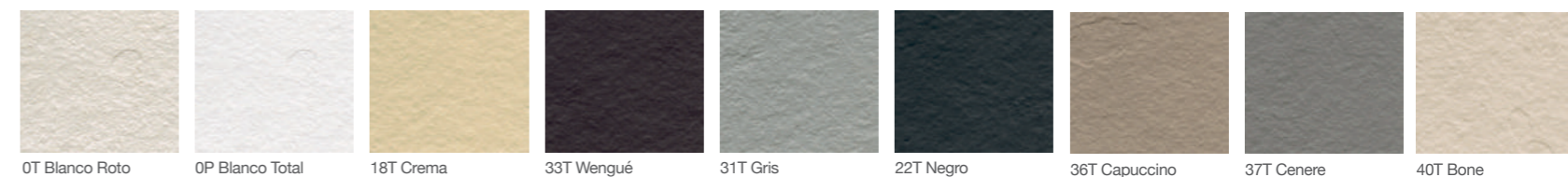

Paneles para alicatar

Wall panels | Panneaux d'habillage | Wandpanelen

.....
SKIN PANELS



Skin Panels

Paneles para alicatar | Wall panels | Panneaux d'habillage | Wandpanelen

Paneles para rehabilitaciones
Panels for remodeling projects
Panneaux pour rénovations
Panelen voor verbouwingen

Información Técnica
Technical information
Informations Techniques
Technische Informatie

P.

15, 16, 19, 20, 22,
25, 38, 42, 54, 60

P.

15, 16, 19, 20, 22,
25, 38, 42, 54, 60

Skin Panels - Paneles para alicatar -

Wall panels | Panneaux d'habillage | Wandpanelen

Perfecto para rehabilitaciones.

Perfect for remodeling projects
 Idéal pour les rénovations
 Ideaal voor verbouwingen



Instalación.
 Más fácil, imposible.

Installation. It couldn't be easier.
 Installation. Impossible de faire plus simple.
 Montage. Gemakkelijker gaat niet.



01

Pegado con silicona
 Glued with silicone
 Collage au silicone
 Gelijmd met silicone



02

Uniones perfectas
 Perfect joints
 Joints parfaits
 Perfecte voeging



03

Instalación fácil
 Easy installation
 Installation simple
 Eenvoudig te installeren



04

Fabricación a medida
 Made to measure
 Fabrication sur mesure
 Vervaardiging op maat

> 2400 MM



NT13 Stucco
 Nature Plata K
 1000x2400mm

L 700/800/900/1000 MM

Skin Panels

Paneles para alicatar
Wall panels
Panneaux d'habillage
Wandpanelen

10 Texturas de distintos estilos.

10 Different-style textures.

10 Textures dans des styles différents.

10 Texturen met verschillende stijlen.



Skin Panels

Wall panels | Panneaux d'habillage | Wandpanelen

Colores sólidos
y nature que
ofrecen más de 60
posibilidades.

Solid and nature colours
that offer more than 60
possibilities.

Couleurs Uniformes et
nature offrant plus de 60
possibilités.

Solide en nature kleuren
die meer dan 60
mogelijkheden bieden.

Skin Panels

Wall panels | Panneaux d'habillage | Wandpanelen

Perfecto para rehabilitaciones

Perfect for remodeling projects
 Idéal pour les rénovations
 Ideaal voor verbouwingen



1

Sólo el espacio de la ducha
 Only the shower area
 Uniquement l'espace de la douche
 Alleen de doucheruimte

2

Toda la pared
 The entire wall
 Toute le mur
 De hele wand

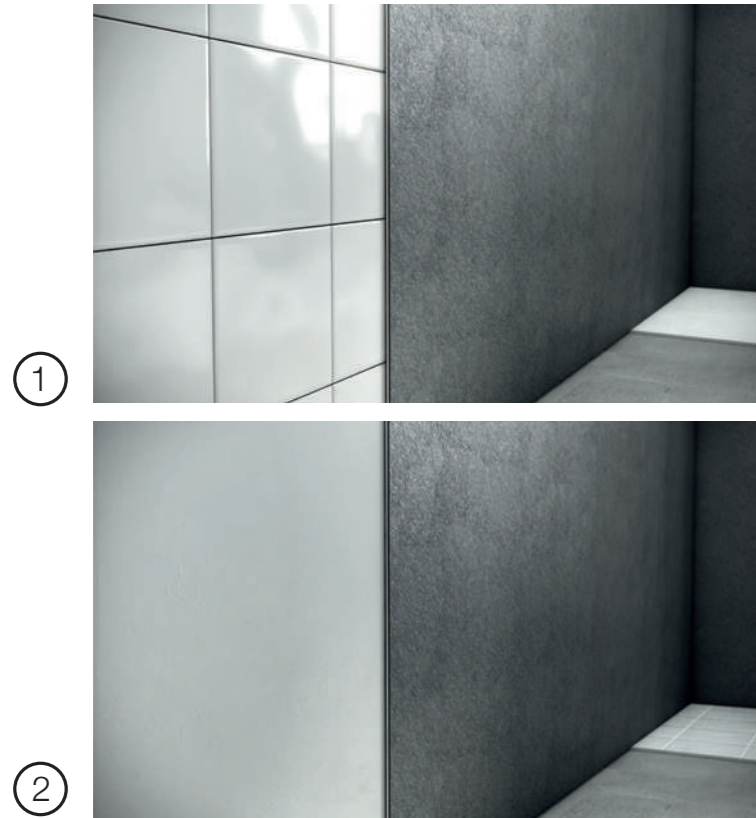

1

2

1. Sobre baldosa
 On tiles
 Sur carrelage
 Op tegels

2. Sobre pared nueva
 On a new wall
 Mur neuf
 Op nieuwe wand



ANTES

Before
 Avant
 Voor



DESPUÉS

After
 Après
 Na





Cambio de bañera por ducha
 Changing a bathtub for a shower
 Remplacement de baignoire par une douche
 Vervanging van een bad door een douche

Skin + Platos de Ducha =

Paneles para alicatar
 Wall panels
 Panneaux d'habillage
 Wandpaneele

Plato de Ducha
 Shower Tray
 Receveur de Douche
 Douchebak

Paneles para paredes
 Wall panels
 Panneaux d'habillage
 Wandpaneele



2

Plato de Ducha
 Shower Tray
 Receveur de Douche
 Douchebak

1



VENTAJAS | ADVANTAGES | AVANTAGES | VOORDELEN



2 Paredes
 2 Walls
 2 Murs
 2 Wanden



3 Paredes
 3 Walls
 3 Murs
 3 Wanden

> Rápida Instalación
 Quick installation
 Rapidité d'installation
 Snelle Montage

> Obra mínima
 Minimal construction work
 Moins de travaux
 Minimale werkzaamheden

> Colores & texturas para decorar
 Colours & textures for decorating
 Couleurs & textures pour décorer
 Kleuren & texturen om te decoreren



Skin Panels

Cambio de plato ducha antiguo por nuevo
Change of an old shower tray for a new one
Remplacement d'un vieux Receveur de Douche par un neuf
Vervanging van oude douchebak door nieuwe

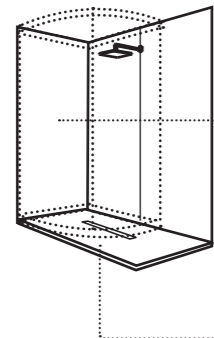

Paneles para paredes
Wall panels
Panneaux d'habillage
Wandpaneelen

2

Plato de Ducha
Shower Tray
Receveur de Douche
Douchebak

1



Ducha antigua
Old shower
Ancienne douche
Oude douche



Colocación plato y paneles
Fitting the tray and panels
Mise en place plateau et panneaux
Plaatsing van bak en panelen



Skin Panels

Información Técnica | Technical Information | Informations Techniques | Technische Informatie

Dimensiones | Dimensions | Dimensions | Afmetingen



2200 > 2400 MM

700/750/800/900/1000 MM

Click para instalar
Click to install
Installation en un clic
Click om te installeren

Sistema de colocación sobre baldosa
System for installing on tiles
Système d'installation sur carrelage
Montagesysteem op tegel

Video Rehabilitación | Refurbishment video
Vidéo Rénovation | Video Verbouwing



Video Instalación | Installation video | Vidéo Rénovation | Video Installatie



www.youtube.es/fiora

Texturas & Colores | Textures & Colours | Textures & Couleurs | Texturen & Kleuren

OAK

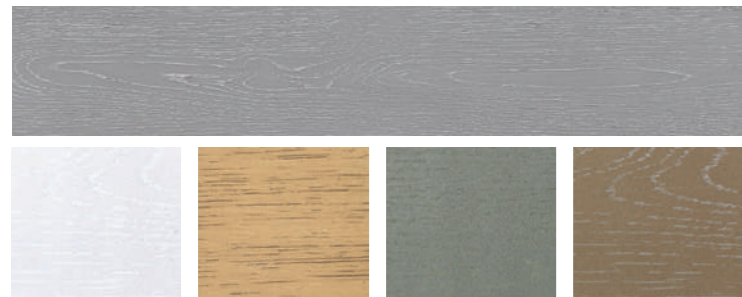

NT10 Nature Blanco K NT12 Nature Crema K NT13 Nature Plata K NT11 Nature Champán K

LISO



K0 Blanco K K2 Crema K K3 Plata K K1 Champán K

NINFA

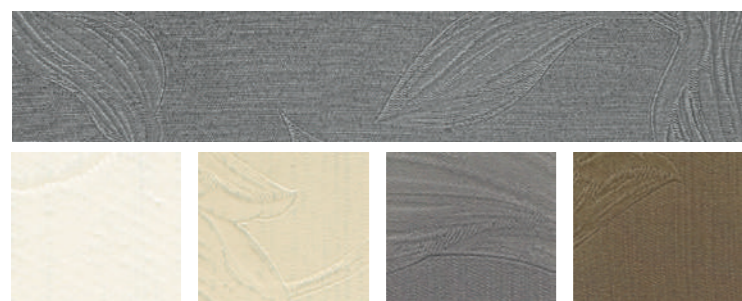

K0 Blanco K K2 Crema K K3 Plata K K1 Champán K

ROSAS

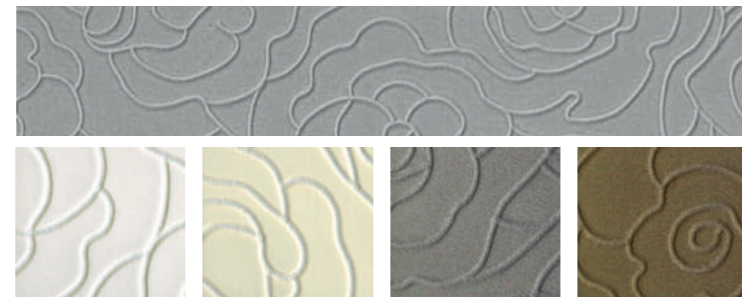

K0 Blanco K K2 Crema K K3 Plata K K1 Champán K

LINEAS

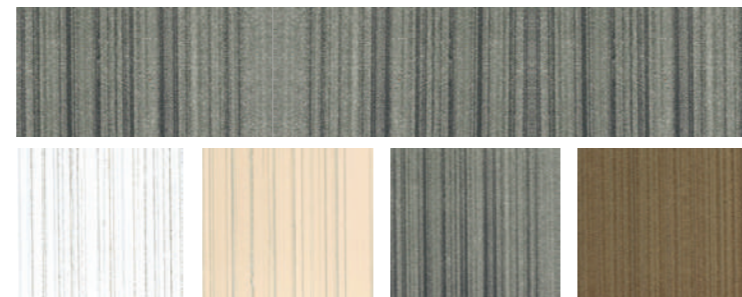

K0 Blanco K K2 Crema K K3 Plata K K1 Champán K

SACO

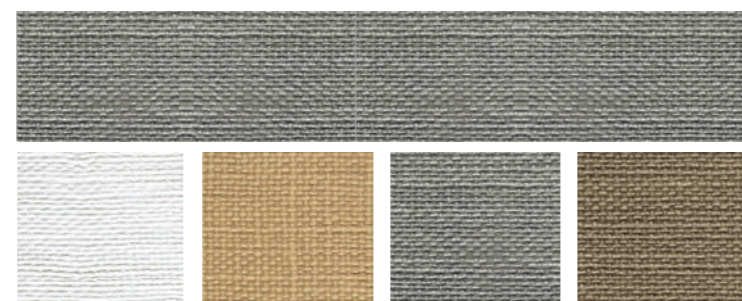

K0 Blanco K K4 Tostado K K3 Plata K K1 Champán K

Texturas & Colores | Textures & Colours | Textures & Couleurs | Texturen & Kleuren

PIZARRA



Colores Sólidos | Solid Colours | Couleurs Uniformes | Solide Kleuren



0T Blanco Roto 0P Blanco Total 18T Crema 33T Wengué 31T Gris 22T Negro 36T Capuccino 37T Cenere 40T Bone

Colores Nature | Nature Colours | Couleurs Nature | Nature Kleuren

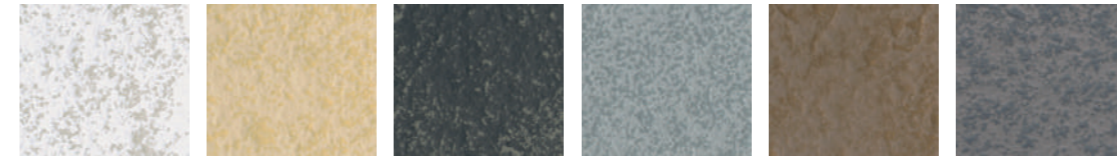

NT0 Nature Blanco NT1 Nature Crema NT2 Nature Negro NT3 Nature Gris NT4 Nature Capuccino NT5 Nature Cenere

LAMAS



Colores Sólidos | Colori a tinta unita | Couleurs Uniformes | Solide Farben



0T Blanco Roto 0P Blanco Total 18T Crema 33T Wengué 31T Gris 22T Negro 36T Capuccino 37T Cenere 40T Bone

Colores Nature | Colori Nature | Couleurs Nature | Nature-Farben

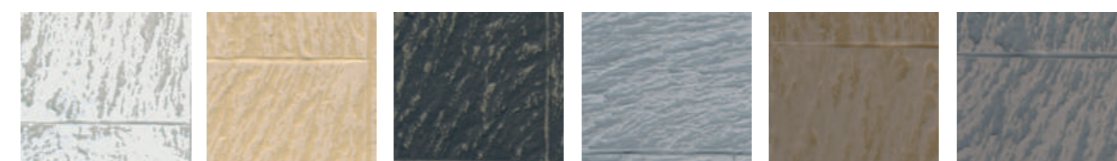

NT0 Nature Blanco NT1 Nature Crema NT2 Nature Negro NT3 Nature Gris NT4 Nature Capuccino NT5 Nature Cenere

STUCCO

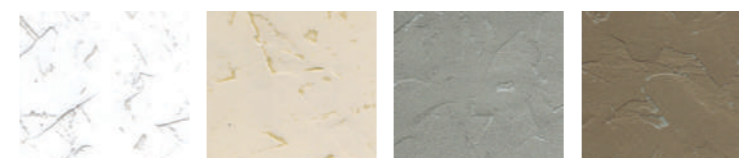

NT10 Nature Blanco K NT12 Nature Crema K NT13 Nature Plata K NT11 Nature Champán K

RUSTICA Colores Sólidos | Solid Colours | Couleurs Uniformes | Solide Kleuren

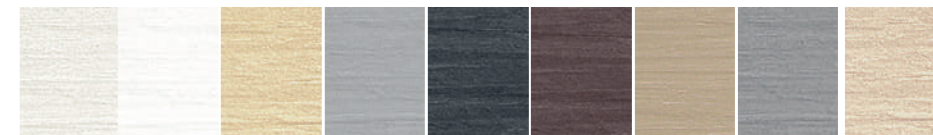

0T Blanco Roto 0P Blanco Total 18T Crema 31T Gris 22T Negro 33T Wengué 36T Capuccino 37T Cenere 40T Bone

RUSTICA Colores Nature | Nature Colours | Couleurs Nature | Nature Kleuren

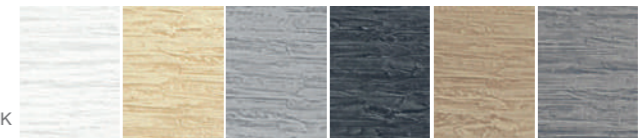

NT0 Nature Blanco NT1 Nature Crema NT3 Nature Gris NT2 Nature Negro NT4 Nature Capuccino NT5 Nature Cenere

Radiadores

Radiators | Radiateurs | Radiatoren

VULCANO HIDRO | VULCANO ELECTRIC



Vulcano Electric

Radiadores | Radiators | Radiateurs | Radiatoren

Baño
Bathroom
Salle de bains
Badkamer

Hogar
Home
Maison
Woning

Información Técnica
Technical Information
Informations Techniques
Technical Information

P.
15, 16, 19, 20, 22,
25, 38, 42, 54, 60

P.
15, 16, 19, 20, 22,
25, 38, 42, 54, 60

P.
15, 16, 19, 20, 22,
25, 38, 42, 54, 60



Vulcano Electric

Radiadores | Radiators | Radiateurs | Radiatoren

Radiadores con control de temperatura digital y programable.

Radiators with digital and programmable temperature control.

Radiatoren met programmeerbare temperatuurregeling.

Radiateurs avec contrôle de température numérique et programmable.

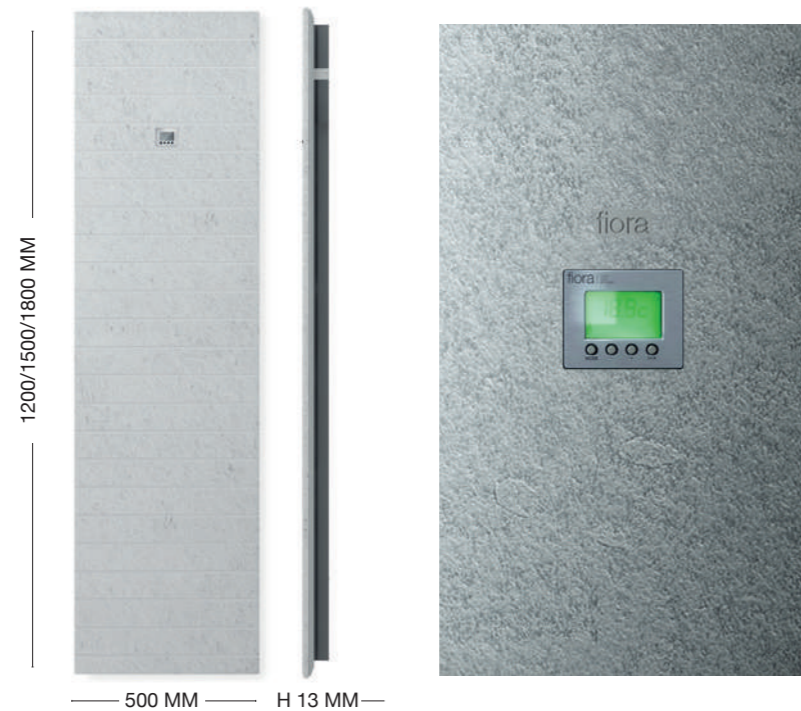

Disponibile en 3 alturas y 1 ancho
(Posibilidad de toallero)

Available in 3 heights and 1 width
(Possibility of towel holder)

Disponibile en 3 hauteurs et 1 largeur
(Possibilité de porte-serviettes)

Verkrijgbaar in 3 hoogtes en 1 breedte
(Handdoekrek optioneel)

Control de temperatura

Temperature control

Contrôle de température

Temperatuurregeling



PIZARRA LAMAS
NT0 Nature Blanco

Vulcano Electric

Radiadores | Radiators | Radiateurs | Radiatoren

8 Texturas:
Pizarra, Lamas, Liso,
Rosas, Semillas, Hilos,
Stucco, Rustica.

8 Textures:
Pizarra, Lamas, Liso,
Rosas, Semillas, Hilos,
Stucco, Rustica.

8 Textures:
Pizarra, Lamas, Liso,
Rosas, Semillas, Hilos,
Stucco, Rustica.

8 Texturen:
Pizarra, Lamas, Liso,
Rosas, Semillas, Hilos,
Stucco, Rustica.



LISO 31T Gris



SEMILLAS 31T Gris



PIZARRA NT3 Nature Gris



ROSAS 6N Gris IN



PIZARRA LAMAS NT3 Nature Gris

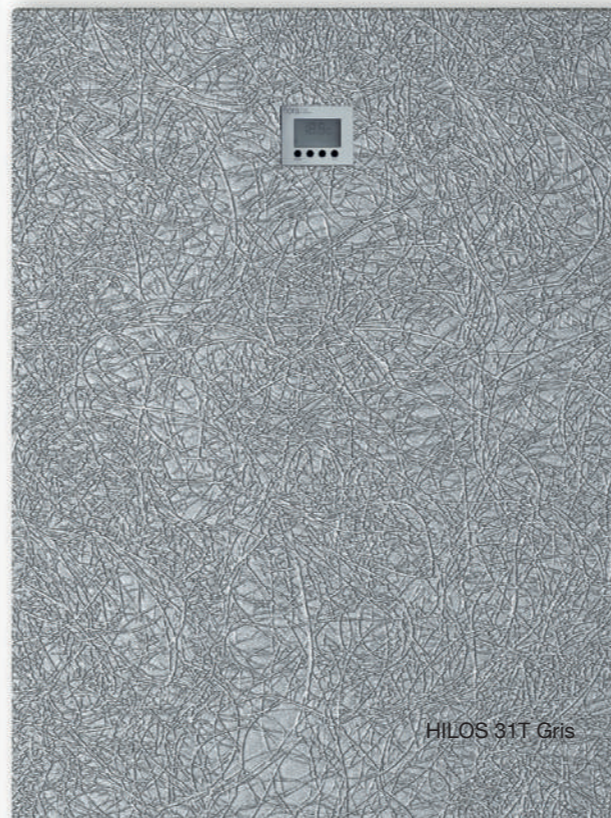

HILOS 31T Gris

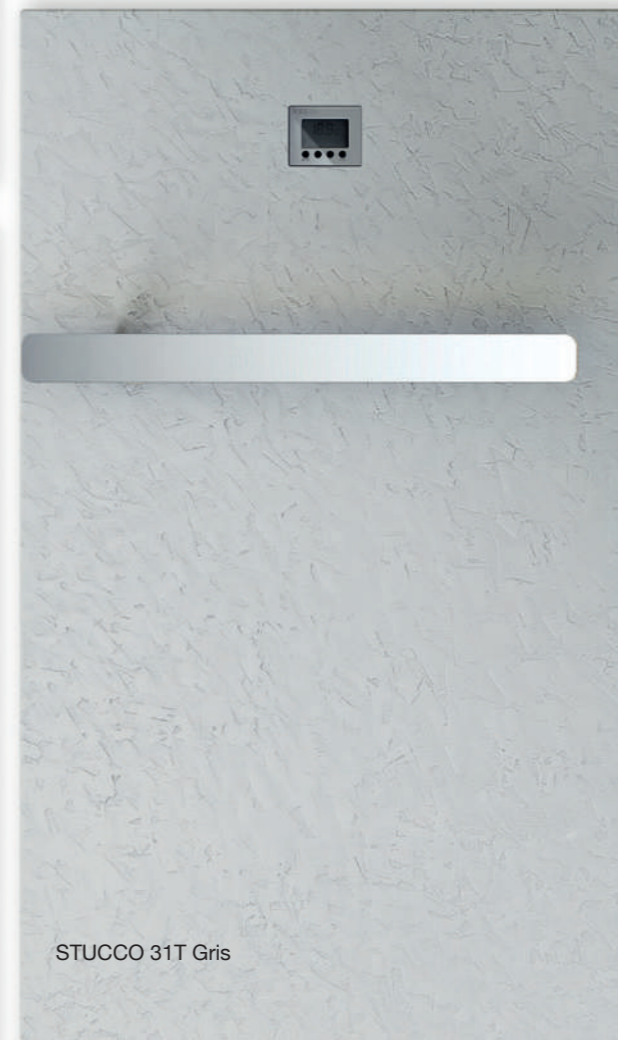

STUCCO 31T Gris



RUSTICA
NT3 Nature Gris



Vulcano Electric

Radiadores | Radiators | Radiateurs | Radiatoren

Colores sólidos y nature
con texturas que ofrecen
más de 60 posibilidades.

Solid and nature colours
with textures that offer
more than 60 possibilities.

Couleurs Uniformes et
nature avec textures offrant
plus de 60 possibilités.

Solide en nature kleuren
met texturen die meer dan
60 mogelijkheden bieden.

Vulcano Electric - en el baño -

In the bathroom | Dans la salle de bains | In de badkamer

Combinado con otros productos Fiora
Combined with other Fiora products
Coordonné aux autres produits Fiora
Gecombineerd met andere Fiora-producten

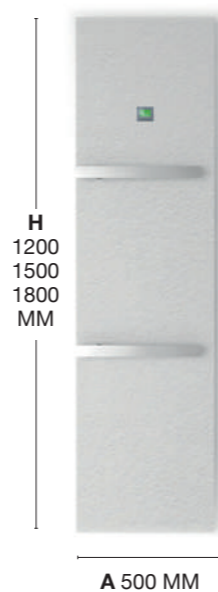

Ejemplo de combinación con panel Skin y platos de ducha
Example of combination with Skin panel and shower trays
Exemple de coordination avec panneau Skin et Receveurs de Douche
Voorbeeld van combinatie met Skin paneel en douchebakken



Vulcano Electric - en el hogar -

Aplicaciones en el hogar: sala, despacho, cocina...

Applications in the home: living room, office, kitchen...

Applications dans la maison : salle, bureau, cuisine...

Toepassingen in de woning: woonkamer, kantoor, keuken...



⏪ Pizarra Nature Cenere ⏩ Pizarra Lamas Nature Blanco



Vulcano Electric

Información Técnica | Technical Information | Informations Techniques | Technische Informatie

Dimensiones | Dimensions | Dimensions | Afmetingen

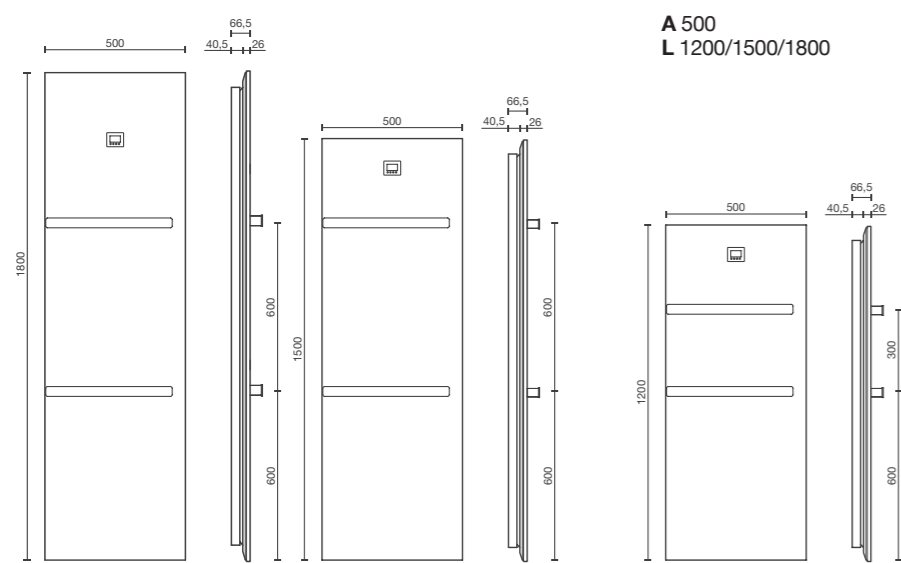

A 500
L 1200/1500/1800



> Sistema de enganche
Hooking system
Système de fixation
Bevestigingssysteem



1. Detalle pantalla
Screen detail
Détail écran
Detail scherm
2. Detalle enchufe
Socket detail
Détail branchement
Detail stopcontact
3. Detalle toallero
Towel holder detail
Détail porte-serviettes
Detail handdoekrek

Texturas & Colores | Textures & Colours | Textures & Couleurs | Texturen & Kleuren

PIZARRA

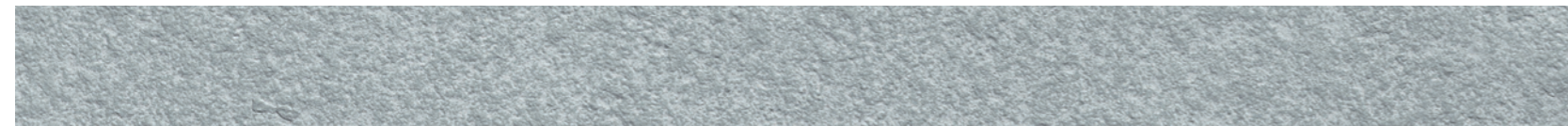

Colores Sólidos | Solid Colours | Couleurs Uniformes | Solide Kleuren

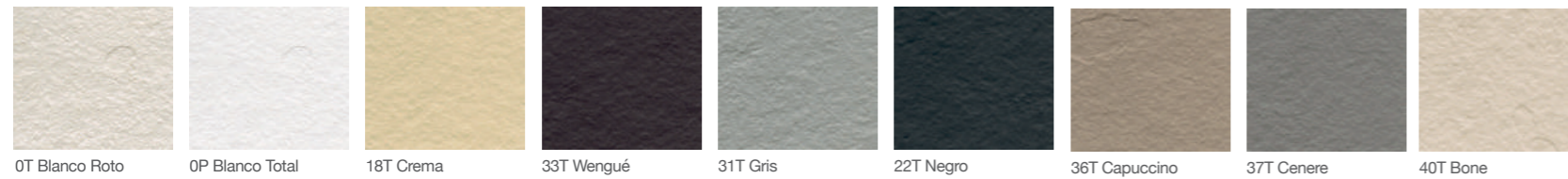

Colores Nature | Nature Colours | Couleurs Nature | Nature Kleuren

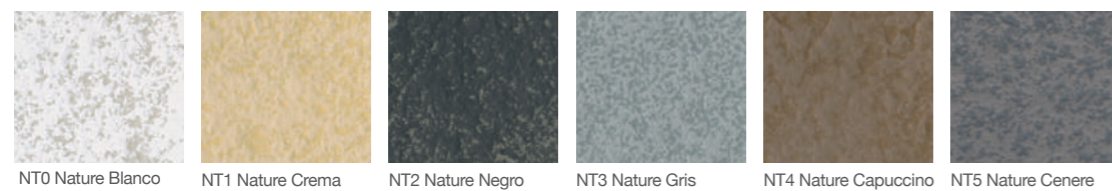

Texturas & Colores | Textures & Colours | Finitions & Couleurs | Texturen & Kleuren

LAMAS

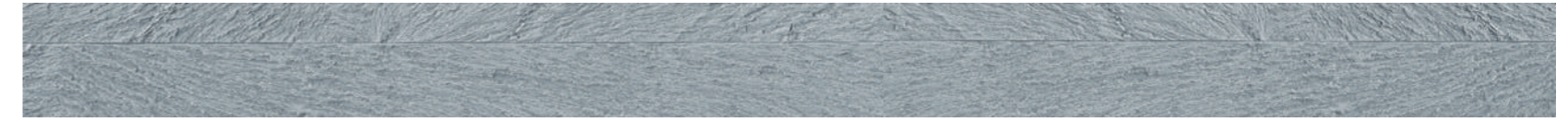

Colores Sólidos | Solid Colours | Couleurs Uniformes | Solide Kleuren



Colores Nature | Nature Colours | Couleurs Nature | Nature Kleuren

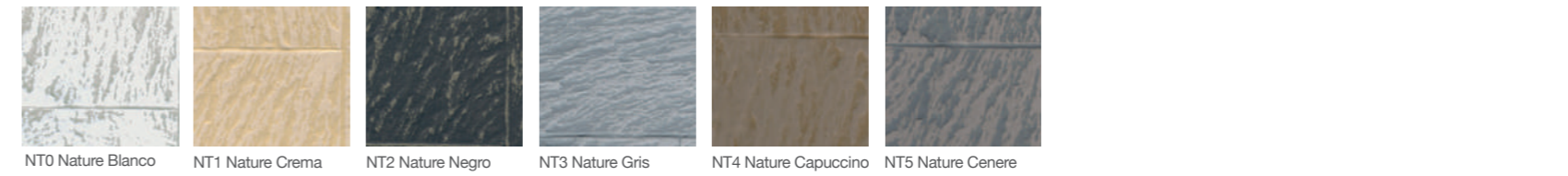

SEMILLAS

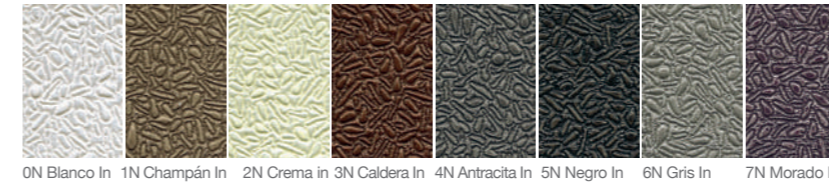

ROSAS

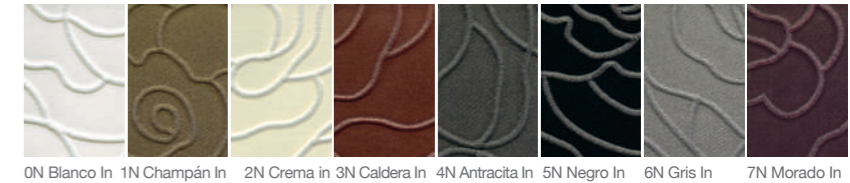
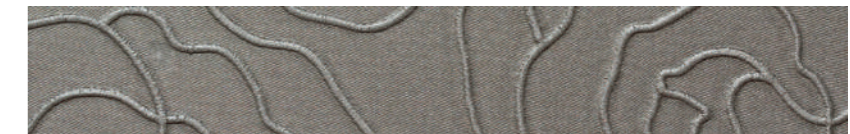

HILOS

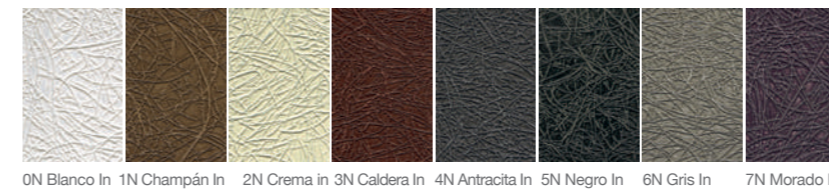
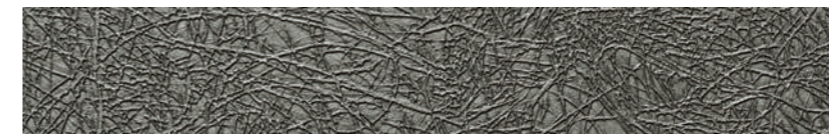

RUSTICA Colores Sólidos | Solid Colours | Couleurs Uniformes | Solide Kleuren



STUCCO

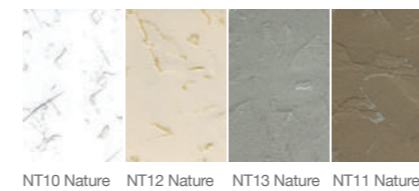

LISO

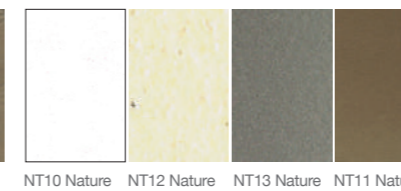
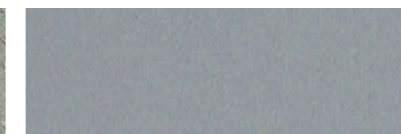

Colores Nature | Nature Colours | Couleurs Nature | Nature Kleuren

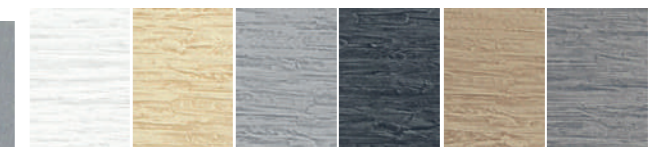

Vulcano Hidro

Radiadores | Radiators | Radiateurs | Radiatoren

Baño
Bathroom
Salle de bains
Badkamer

Hogar
Home
Maison
Woning

Información Técnica
Technical Information
Informations Techniques
Technische Informatie

P.
15, 16, 19, 20, 22,
25, 38, 42, 54, 60

P.
15, 16, 19, 20, 22,
25, 38, 42, 54, 60

P.
15, 16, 19, 20, 22,
25, 38, 42, 54, 60



Vulcano Hidro

Radiadores | Radiators | Radiateurs | Radiatoren

Radiadores de agua para el baño y el hogar.

Water radiators for the bathroom and the home.

Radiateurs à eau pour la salle de bains et toute la maison.

Waterradiators voor de badkamer en de woning.



Disponibile en 3 alturas y 1 ancho
(Posibilidad de toallero)
Available in 3 heights and 1 width
(Possibility of towel holder)
Disponibile en 3 hauteurs et 1 largeur
(Possibilité de porte-serviettes)
Verkrijgbaar in 3 hoogtes en 1 breedte
(Handdoekrek optioneel)



Vulcano Hidro

Radiadores | Radiators | Radiateurs | Radiatoren

5 Texturas:
Pizarra,
Lamas, Rosas,
Semillas, Hilos.
Colores sólidos
y Nature.

5 Textures:
Pizarra, Lamas, Rosas,
Semillas, Hilos.
Solid and Nature colours.

5 Textures:
Pizarra, Lamas, Rosas,
Semillas, Hilos.
Couleurs Uniformes et Nature.

5 Texturen:
Pizarra, Lamas, Rosas,
Semillas, Hilos.
Solide en Nature Kleuren.



PIZARRA



LAMAS



HILOS



ROSAS

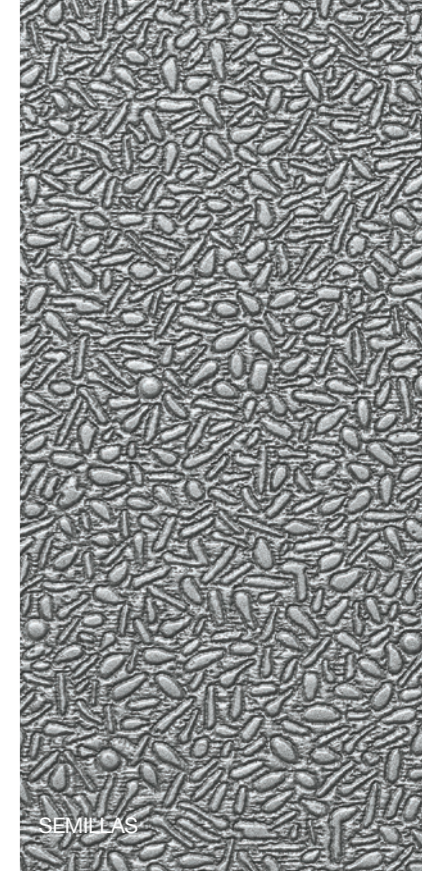

SEMILLAS

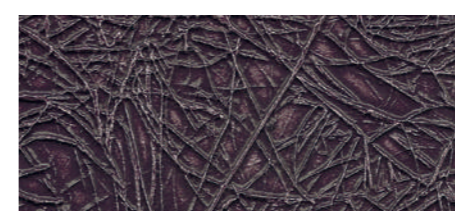
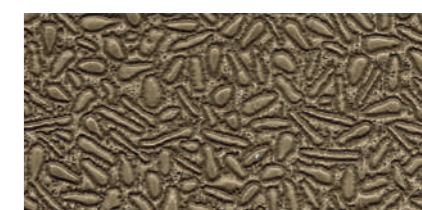
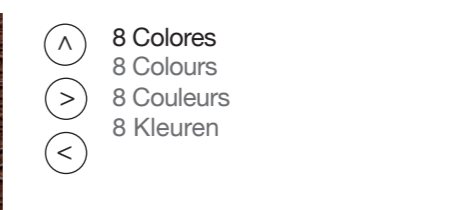
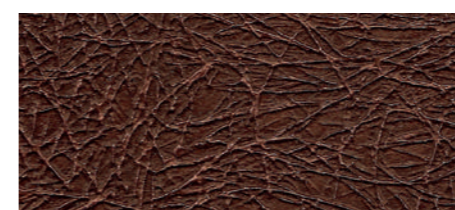
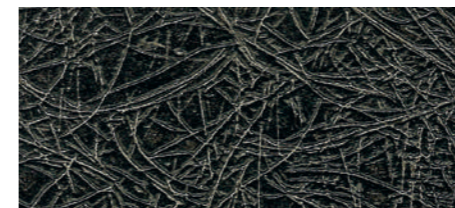
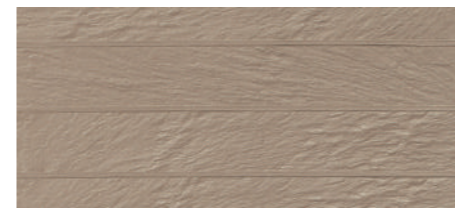
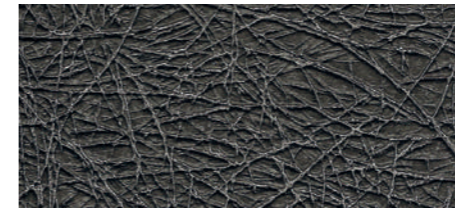
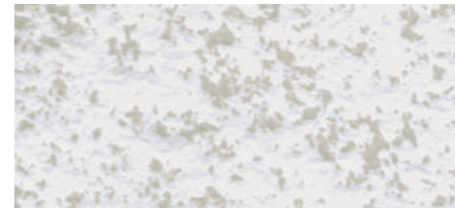

8 Colores Sólidos + 6 Colores Nature
8 Solid Colours + 6 Nature Colours
8 Colores Pleines + 6 Couleurs Nature
8 Solide kleuren + 6 Nature kleuren

⤴ 8 Colores
8 Colours
8 Couleurs
8 Kleuren

8 Colores Sólidos + 6 Colores Nature
8 Solid Colours + 6 Nature Colours
8 Colores Pleines + 6 Couleurs Nature
8 Solide kleuren + 6 Nature kleuren

Vulcano Hidro - en el baño -

In the bathroom | Dans la salle de bains | In de badkamer

Combinado con otros productos Fiora
 Combined with other Fiora products
 Coordonné aux autres produits Fiora
 Gecombineerd met andere Fiora-producten



Detalle toallero
 Towel holder detail
 Détail porte-serviettes
 Detail handdoekrek

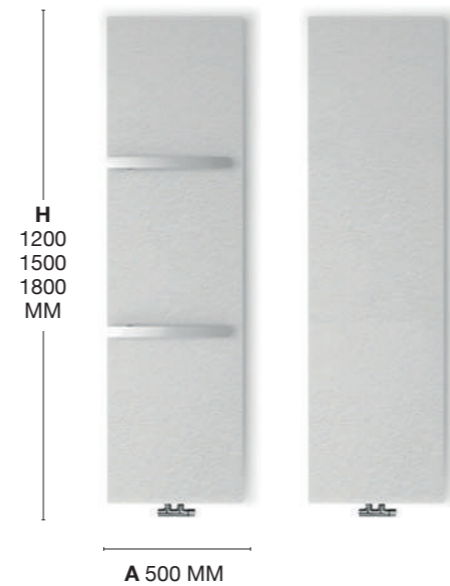

Radiador Hidro Baño 1,80 Pizarra Blanca
 1.80 Hidro Bathroom Radiator Pizarra Blanca
 Radiateur Hidro Bain 1,80 Pizarra Blanca
 Radiator Hidro Badkamer 1,80 Pizarra Blanca



Radiador Hidro Baño 1,80 Semillas Oro
 1.80 Hidro Bathroom Radiator Semillas Oro
 Radiateur Hidro Bain 1,80 Semillas Oro
 Radiator Hidro Badkamer 1,80 Semillas Oro



Vulcano Hidro - en el baño -

In the bathroom | Dans la salle de bains | In de badkamer

Combinado con otros productos Fiora
Combined with other Fiora products
Coordonné aux autres produits Fiora
Gecombineerd met andere Fiora-producten



Radiador Hidro Baño 1,80 Pizarra Blanca
1.80 Hidro Bathroom Radiator Pizarra Blanca
Radiateur Hidro Bain 1,80 Pizarra Blanca
Radiator Hidro Badkamer 1,80 Pizarra Blanca



Radiador Hidro Baño 1,80 Lamas Gris
1.80 Hidro Bathroom Radiator Lamas Gris
Radiateur Hidro Bain 1,80 Lamas Gris
Radiator Hidro Badkamer 1,80 Lamas Gris



Vulcano Hidro

Información Técnica | Technical Information | Informations Techniques | Technische Informatie

Dimensiones | Dimensions | Dimensions | Afmetingen



A 500
L 1200/1500/1800

> 3 medidas disponibles con posibilidad de toallero
3 sizes available with possibility of towel holder
3 dimensions disponibles avec possibilité de porte-serviettes
3 verkrijgbare afmetingen met optioneel handdoekrek

Texturas & Colores | Textures & Colours | Textures & Couleurs | Texturen & Kleuren

PIZARRA

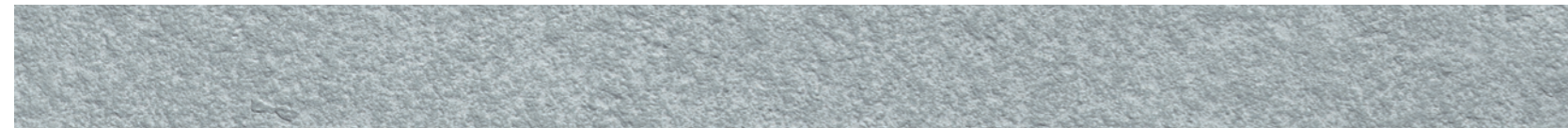

Colores Sólidos | Solid Colours | Couleurs Uniformes | Solide Kleuren

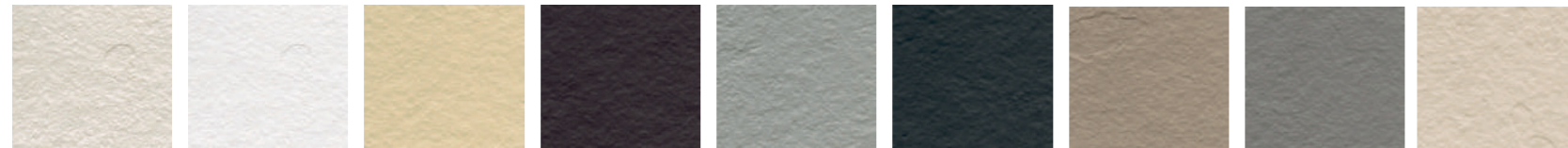

0T Blanco Roto 0P Blanco Total 18T Crema 33T Wengué 31T Gris 22T Negro 36T Capuccino 37T Cenere 40T Bone

Colores Nature | Nature Colours | Couleurs Nature | Nature Kleuren

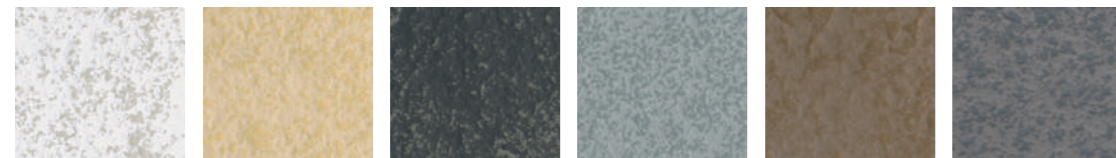

NT0 Nature Blanco NT1 Nature Crema NT2 Nature Negro NT3 Nature Gris NT4 Nature Capuccino NT5 Nature Cenere

Texturas & Colores | Textures & Colours | Textures & Couleurs | Texturen & Kleuren

LAMAS



Colores Sólidos | Solid Colours | Couleurs Uniformes | Solide Kleuren



0T Blanco Roto 0P Blanco Total 18T Crema 33T Wengué 31T Gris 22T Negro 36T Capuccino 37T Cenere 40T Bone

Colores Nature | Nature Colours | Couleurs Nature | Nature Kleuren

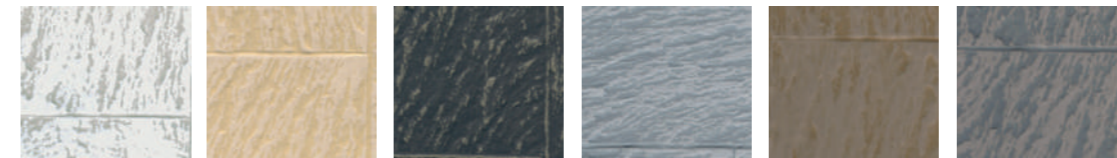

NT0 Nature Blanco NT1 Nature Crema NT2 Nature Negro NT3 Nature Gris NT4 Nature Capuccino NT5 Nature Cenere

SEMILLAS

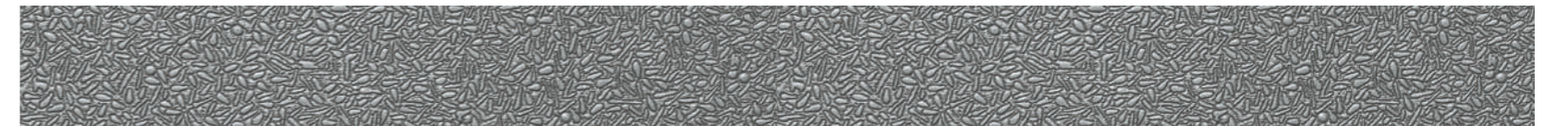

0N Blanco IN 1N Champán IN 2N Crema IN 3N Caldera IN 5N Antracita IN 5N Negro IN 6N Gris IN 7N Morado IN

ROSAS



0N Blanco IN 1N Champán IN 2N Crema IN 3N Caldera IN 4N Antracita IN 5N Negro IN 6N Gris IN 7N Morado IN

HILOS

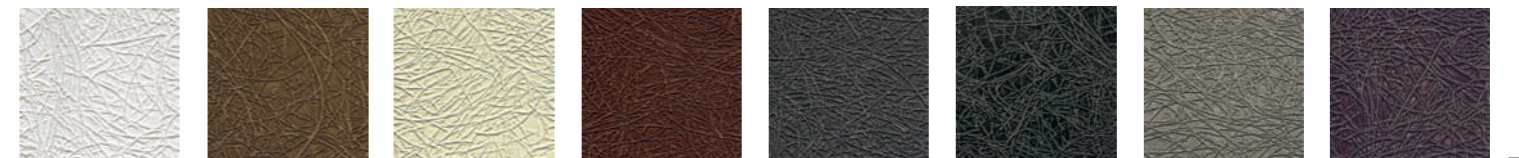
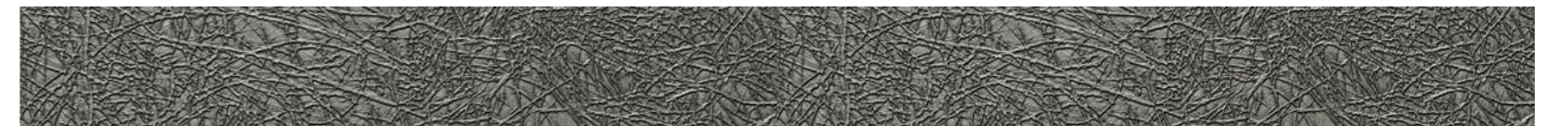

0N Blanco IN 1N Champán IN 2N Crema IN 3N Caldera IN 4N Antracita IN 5N Negro IN 6N Gris IN 7N Morado IN



Mobiliario de Baño

Bathroom Furniture | Mobilier de Salle de Bains | Badkamermeubilair

MAKING | INTOUCH | VIVALDI

Making

Mobiliario de Baño | Bathroom Furniture | Mobilier de Salle de Bains | Badkamermeubilair

COLECCIÓN MODULAR | MODULAR COLLECTION | COLLECTION MODULAIRE | MODULAIRE COLLECTIE

Ejemplos de modularidad
Examples of modularity
Exemples de modularité
Voorbeelden van modulariteit

Ambientes
Atmospheres
Environnements
Omgeving

Mini
Mini
Mini
Mini

Información Técnica
Technical Information
Informations Techniques
Technische Informatie

P.

168, 169, 170,
171

P.

172, 173, 174, 175,
176, 177, 178, 179,
180, 181, 182, 183,
184, 185, 186, 187,
188, 189, 190, 191,
192, 193, 194

P.

195, 196,
197, 198

P.

199, 200



Making

Mobiliario de Baño | Bathroom Furniture | Mobilier de Salle de Bains | Badkamermeubilair

Con 3 texturas: Pizarra, Liso, Stucco.

With 3 textures:
Pizarra, Liso, Stucco.

Avec 3 Textures :
Pizarra, Liso, Stucco.

Met 3 texturen:
Pizarra, Liso, Stucco.

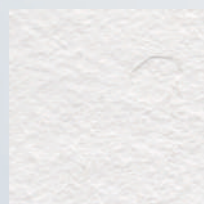

PIZARRA

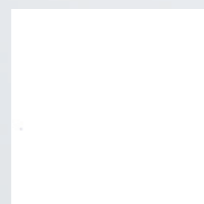

LISO

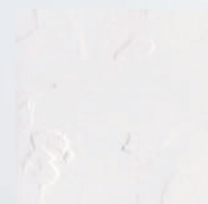

STUCCO



Making

Mobiliario de Baño | Bathroom Furniture | Mobilier de Salle de Bains | Badkamermeubilair

15 Colores totalmente combinables, sólidos y nature

15 Totally combinable colours, solid and nature

15 couleurs entièrement coordonnables, pleines et nature

15 geheel combineerbare kleuren, solide en nature

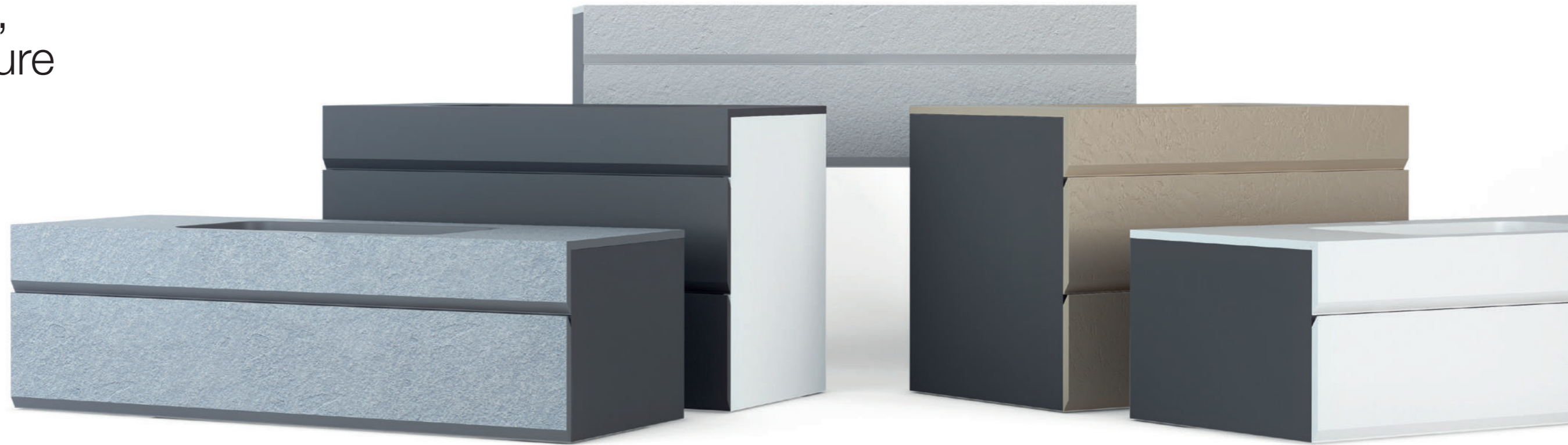

Making

Mobiliario de Baño | Bathroom Furniture | Mobilier de Salle de Bains | Badkamermeubilair

Et voilà!

Ejemplos de composiciones suspendidas ligeras.

Examples of light wall hung arrangements.

Exemples de compositions suspendues légères.

Voorbeelden van lichte hangende samenstellingen.



Making

Mobiliario de Baño | Bathroom Furniture | Mobilier de Salle de Bains | Badkamermeubilair

Without limits!

Ejemplos de composiciones de gran capacidad.
Examples of large capacity arrangements.
Exemples de compositions à grande contenance.
Voorbeelden van samenstellingen met grote capaciteit.





Making

Mobiliario de Baño | Bathroom Furniture
 Mobilier de Salle de Bains | Badkamermeubilair

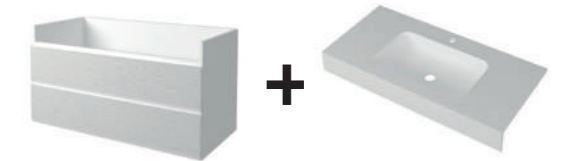

Mueble suspendido 2 cajones + Encimera integrada de 120
 Wall hung vanity unit with 2 drawers + built-in 120 vanity top
 Meuble suspendu 2 tiroirs + Plan intégré de 120
 Ophangmeubel met 2 lades + Ingebouwd bovenblad van 120

L 1200 X P 480 X H 576



Espejo di Base
 Di Base mirror
 Miroir di Base
 Di Base spiegel

L 1200 X P 16 X H 700



Columna con puerta
 High cabinet with door
 Colonne avec porte
 Kolomkast met deur

L 400 X P 335 X H 1020



STUCCO
 31T Gris





Making

Mobiliario de Baño | Bathroom Furniture
 Mobilier de Salle de Bains | Badkamermeubilair



3 Muebles suspendidos 1 cajón + Lavabos sobremesa IOTA
 3 Wall hung vanity units with 1 drawer + IOTA table top wash basins
 3 Meubles suspendus 1 tiroir + Vasques à poser IOTA
 3 ophangmeubels met 1 lade + Wastafels opbouwmodel IOTA

L 2100 X P 480 X H 346

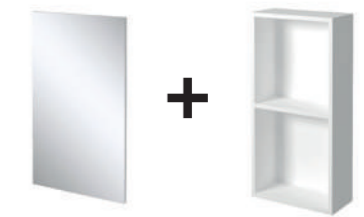

2 Espejo di Base + 2 Colgables abiertos
 2 Di Base mirrors + 2 open wall vanity units
 2 Miroirs di Base + 2 Éléments suspendus ouverts
 2 Di Base spiegel + 2 open hangkasten

L 700 X P 15 X H 700 L 358 X P 156 X H 700



STUCCO
 NT13 Nature Plata



Making

Mobiliario de Baño | Bathroom Furniture
Mobilier de Salle de Bains | Badkamermeubilair



Consola integrada desplazada lavabo grande
Console with built-in offset small wash basin
Console intégrée décalée grande vasque
Console ingebouwd niet-gecentreerd wastafel groot

L 1800 x P 480 x H 130

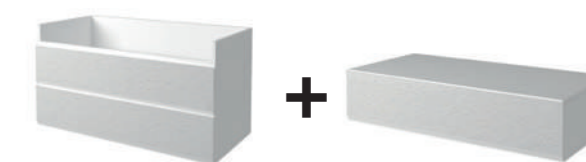

Mueble 2 cajones y tocador doble con tapa
Vanity unit 2 drawers and Vanity cabinet
Meuble 2 tiroirs et coiffeuse
Meubel met 2 lades en toilettafel

L 1800 X P 480 X H 576



Espejo enmarcado textura
Textured framed mirror
Miroir encadré avec texture
Spiegel met lijst met textuur

L 1800 X P 16 X H 710



STUCCO
0P Blanco Total

Making

Mobiliario de Baño | Bathroom Furniture | Mobilier de Salle de Bains | Badkamermeubilair



Mueble 2 cajones con baldas de 1200
Vanity unit 2 drawers with 120 shelves
Meuble 2 tiroirs avec étagères de 120
Meubel met 2 lades met legplanken van 120

L 1200 X P 480 X H 576



Espejo camerino de 1200
120 mirror cabinet
Miroir loge de 120
Spiegelkast van 120

L 1200 X P 115 X H 700



PIZARRA
22T Negro



Mueble 3 cajones y con baldas
Vanity unit 3 drawers and with shelves
Meuble 3 tiroirs et étagères
Meubel met 3 lades en legplanken

L 1200 X P 480 X H 860



Espejo di Base de 1200
1200 Di Base mirror
Miroir di Base de 1200 mm
Di Base spiegel van 1200

L 1200 X P 15 X H 700



Colgables abiertos
Open wall vanity units
Éléments suspendus ouverts
Open hangkasten

L 358 X P 156 X H 358
L 358 X P 156 X H 1042

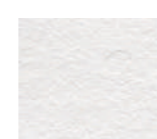

PIZARRA
0P Blanco Total





Making

Mobiliario de Baño | Bathroom Furniture
 Mobilier de Salle de Bains | Badkamermeubilair



Consola integrada desplazada lavabo pequeño
 Console with built-in offset small wash basin
 Console intégrée décalée petite vasque
 Console ingebouwd niet-gecentreerd wastafel klein

L 1300 X P 480



Coqueta 2 cajones + Tocador doble con tapa
 2 Drawer vanity cabinet + Double Vanity cabinet with cover
 Coiffeuse 2 tiroirs + Élément de rangement avec plateau
 Toilettafel met 2 lades + Toilettafelmeubel dubbel met bovenblad

L 2200 X P 480 X H 570

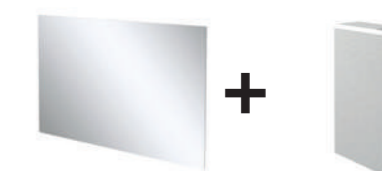

Espejo di Base + Colgable con baldas
 Di Base mirror + Wall vanity unit with shelves
 Miroir de Base + Élément suspendu avec étagères
 Spiegel di Base + Hangkast met legplanken

L 1300 X P 15 X H 700 L 400 X P 175 X H 700



PIZARRA
 NT0 Nature Blanco

Making

Mobiliario de Baño | Bathroom Furniture | Mobilier de Salle de Bainss | Badkamermeubilair

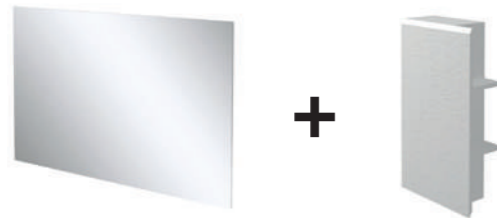

Espejo di Base + Colgable costados vistos
Di Base mirror + Wall vanity unit with open sides
Miroir de Base + Élément suspendu côtés apparents
Di Base spiegel + Hangkast met open zijkanten



PIZARRA
NTO Nature Blanco

L 1300 X P 15 X H 700 L 400 X P 175 X H 700





Making

Mobiliario de Baño | Bathroom Furniture
 Mobilier de Salle de Bainss | Badkamermeubilair

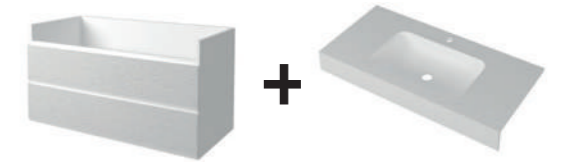

Mueble suspendido 2 cajones + Encimera integrada de 110
 Wall hung vanity unit with 2 drawers + built-in 110 vanity top
 Meuble suspendu 2 tiroirs + Plan intégré de 110
 Ophangmeubel met 2 lades + Ingebouwd bovenblad van 110

L 1100 X P 480 X H 576



Mueble con toallero lateral
 Vanity unit with side towel holder
 Meuble avec porte-serviettes latéral
 Meubel met handdoekrek zijkant



Espejo di Base
 Di Base mirror
 Miroir di Base
 Di Base Spiegel

L 1100 X P 16 X H 700



Colgables abiertos
 Open wall vanity units
 Éléments suspendus ouverts
 Open hangkasten

L 356 X F 156 X H 1042



LISO
 OP Blanco Total

Making

Mobiliario de Baño | Bathroom Furniture | Mobilier de Salle de Bains | Badkamermeubilair



Mueble 1/2 cajones encimera incluida
Vanity unit 1/2 drawers including vanity top
Meuble 1/2 tiroirs plan inclus
Meubel met 1/2 lades bovenblad inbegrepen

L 1200 X P 480 X H 576/346



Espejo enmarcado con textura
Textured framed mirror
Miroir encadré avec texture
Spiegel met lijst met textuur

L 1200 X P 16 X H 700



Espejo camerino
Mirror cabinet
Miroir loge
Spiegelkast

L 1200 X P 115 X H 700

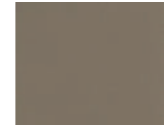

LISO
36T Capuccino



LISO
37T Cenere





Making

Mobiliario de Baño | Bathroom Furniture
 Mobilier de Salle de Bainss | Badkamermeubilair



Consola recta con lavabo sobremesa + Lavabo IOTA
 Straight console with tabletop wash basin + IOTA wash basin
 Console droite pour vasque à poser + Vasque IOTA
 Rechte console met wastafel opbouwmodel + Wastafel IOTA

L 1800 X P 480 X H 130

L 1800 X P 480 X H 110



Mueble tocador con tapa de 180
 Vanity cabinet with cover measuring 180
 Élément de rangement avec plateau de 180
 Meubel toilettafel met bovenblad van 180 mm

L 1800 X P 480 X H 227



Espejo di Base + Applique
 Di Base mirror + Lamp
 Miroir de Base + Applique
 Di Base spiegel + Lichtarmatuur

L 400 X P 15 X H 700



LISO
 36T Capuccino



Making

Mobiliario de Baño | Bathroom Furniture
Mobilier de Salle de Bainss | Badkamermeubilair

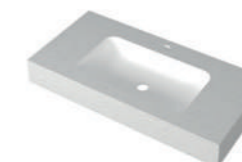

Consola recta lavabo integrado
Straight console built-in wash basin
Console droite vasque intégrée
Rechte console ingebouwde wastafel

L 1200 X F 480 X H 130



Coqueta 2 cajones + Mueble tocador con tapa
2-Drawer vanity cabinet + Vanity cabinet with cover
Coiffeuse 2 tiroirs + Meuble de rangement avec plateau
Toilettafel met 2 lades + Meubel toilettafel met bovenblad

L 1200 X P 480 X H 250



Espejo camerino
Mirror cabinet
Miroir loge
Spiegelkast

L 1200 X P 115 X H 700

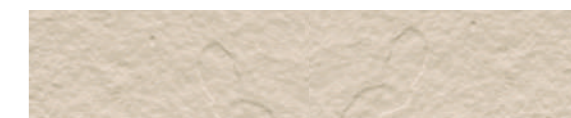

PIZARRA
40T Bone

Making

Mobiliario de Baño | Bathroom Furniture | Mobilier de Salle de Bains | Badkamermeubilair



Monobloc lavabo Delta bajo plano
Monobloc Delta undermount wash basin
Monobloc vasque Delta à encastrer
Monobloc onderhangende wastafel Delta

L 620 X P 435 X H 1710



Monobloc lavabo Gamma sobremesa
Monobloc Gamma table top wash basin
Monobloc vasque Gamma à poser
Monobloc wastafel Gamma opbouwmodel

L 620 X P 435 X H 1710



Making - MINI

Mobiliario de Baño | Bathroom Furniture | Mobilier de Salle de Bains | Badkamermeubilair



Lavabo suspendido Petit
Wall hung Petit wash basin
Vasque suspendue Petit
Onderhangende wastafel Petit

L 450 X P 280 X H 75

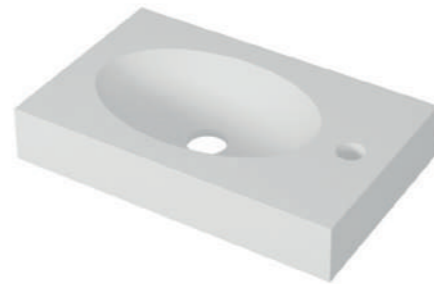

Lavabo suspendido Ovale
Wall hung Ovale wash basin
Vasque suspendue Ovale
Onderhangende wastafel Ovale

L 450 X P 280 X H 75



Espejo con puerta
Mirror with door
Armoire avec porte miroir
Spiegel met deur

L 300 X P 100 X H 600



Making - MINI

Mobiliario de Baño | Bathroom Furniture | Mobilier de Salle de Bains | Badkamermeubilair



Mueble suspendido 1 puerta
Wall hung vanity unit 1 door
Meuble suspendu 1 porte
Ophangmeubel met 1 deur

L 450 X P 280 X H 575

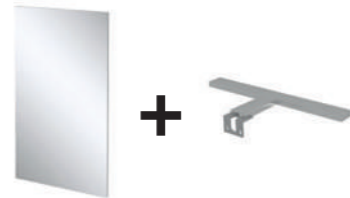

Espejo con aplique
Mirror with lamp
Miroir avec applique
Spiegel met lichtarmatuur

L 400 X P 15 X H 700



PIZARRA
36T Capuccino



LISO
33T Wengé

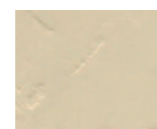

STUCCO
18T Crema



Making

Información Técnica | Technical Information | Informations Techniques | Technische Informatie

Dimensiones & Sistemas de Colocación | Dimensions & Fitting Systems | Dimensions & Systèmes de Pose | Afmetingen & Montagesystemen

3 ALTURAS
3 Heights | 3 Hauteurs | 3 Hoogtes

6 ANCHURAS
6 Widths | 6 Largeurs | 6 Breedtes

2 SIST. DE COLOCACIÓN
2 Fitting Systems | 2 Syst. Pose | 2 Syst. Montage

Suspendido
Wall hung
Suspendu
Wandmontage

Con zócalo
With a base
Sur socle
Met sokkel

Opciones del mueble | Furniture options
Options du meuble | Opties meubel



Baldas Laterales
Side shelves
Étagères Latérales
Legplanken zijkant

Toallero Lateral
Side towel holder
Porte-serviettes Latéral
Handdoekrek zijkant

Colgables | Wall vanity unit
Éléments à suspendre | Hangmeubels



Colgables con puerta
Wall vanity unit with door
Éléments à suspendre avec porte
Hangmeubels met deur

Colgables abierto
Open wall vanity units
Éléments à suspendre ouverts
Open hangkasten

Columnas | Columns
Colonnes | Kolomkasten



Columna con puerta
High cabinet with door
Colonne avec porte
Kolomkast met deur

Columna abierto
Open high cabinet
Éléments à suspendre ouverts
Open hangkasten

Texturas & Colores | Textures and colours | Textures et couleurs | Texturen & Kleuren

PIZARRA

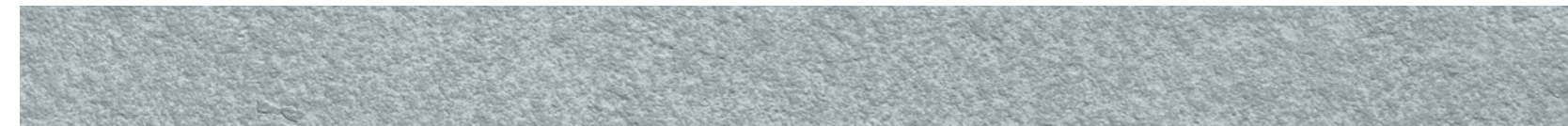

Colores Sólidos | Solid Colours | Couleurs Uniformes | Solide Kleuren

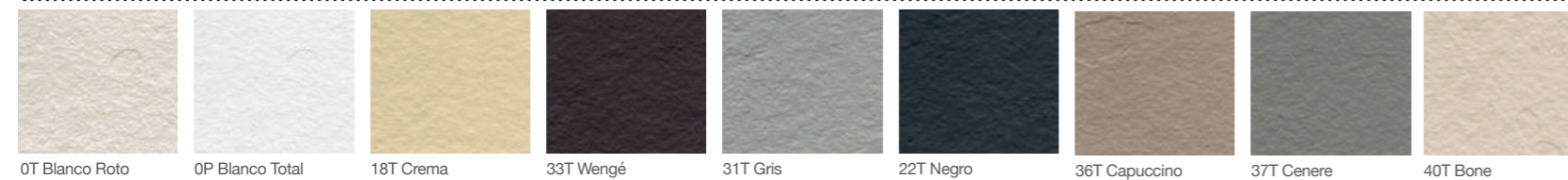

Colores Nature | Nature Colours | Couleurs Nature | Nature Kleuren

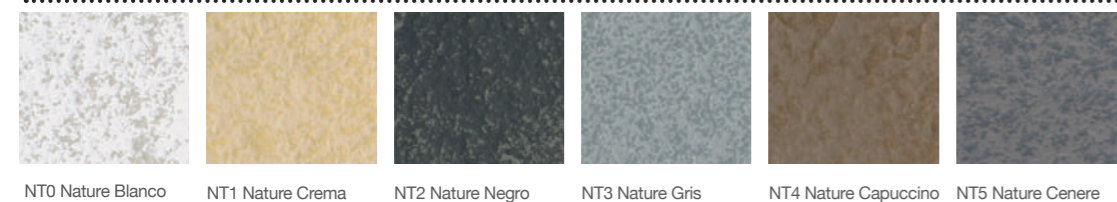

MINI Dimensiones | Dimensions | Dimensions | Afmetingen
Espejo con puerta | Mirror with door | Armoire avec porte miroir | Spiegel met deur

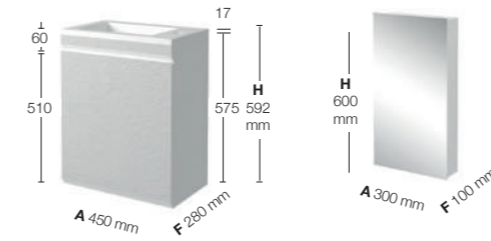

Espejos | Mirrors | Mirrors | Spiegels



Enmarcado Textura
Framed Texture
Encadré Texture
Omlijsting Textuur

Di Base
Di Base
Di Base
Di Base

Espejo camerino
Mirror cabinet
Miroir loge
Met textuur

Texturas & Colores | Textures and colours | Textures et couleurs | Texturen & Kleuren

LISO



Colores Sólidos | Solid Colours | Couleurs Uniformes | Solide Kleuren



Colores IN | IN Colours | Couleurs IN | IN-Kleuren

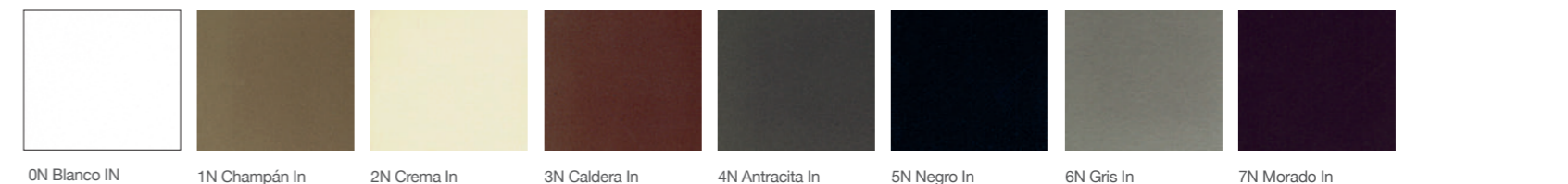

STUCCO



Colores Sólidos | Solid Colours | Couleurs Uniformes | Solide Kleuren

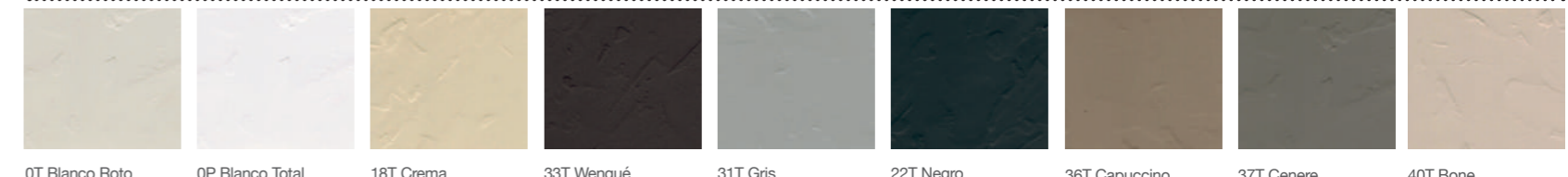

Colores Nature | Nature Colours | Couleurs Nature | Nature Kleuren

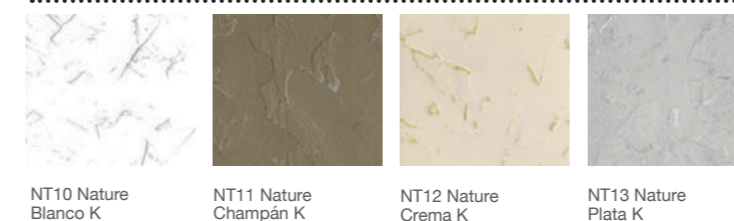

Intouch

Mobiliario de Baño | Bathroom Furniture | Mobilier de Salle de Bains | Badkamermeubelen

DISEÑO&TEXTURAS | DESIGN&TEXTURES | DESIGN&TEXTURES | DESIGN&TEXTURES

Liso	Rosas	Hilos	Semillas	Información Técnica
Liso	Rosas	Hilos	Semillas	Technical Information
Liso	Rosas	Hilos	Semillas	Informations Techniques
Liso	Rosas	Hilos	Semillas	Technische Informatie
P.	P.	P.	P.	P.
206, 207, 208, 209, 212, 218	202, 203, 206, 207, 208, 209, 216, 217, 219	206, 207, 208, 209, 220, 221, 222, 223	206, 207, 208, 209, 224, 225, 226, 227	228, 229

Intouch

Mobiliario de Baño | Bathroom Furniture | Mobilier de Salle de Bains | Badkamermeubilair

Perfilería cromada
perimetral.
Toques de distinción.

Chromed frames perimeter.
Distinctive touches.

Profilés chromés.
Touches d'élégance.

Verchromde omtrekprofielen.
Een elegante touch.



Intouch

Mobiliario de Baño | Bathroom Furniture | Mobilier de Salle de Bains | Badkamermeubilair

Detalles de
alta calidad para
un diseño único.

High quality details for a
unique design.

Finitions de haute qualité pour
un design unique.

Hoogwaardige details voor
een uniek ontwerp.

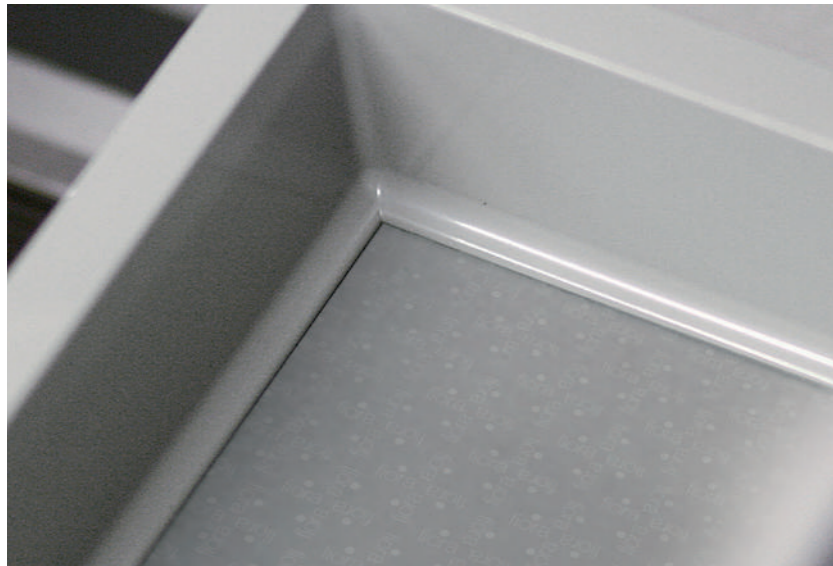

⤴ Fondos antideslizantes
Non-slip bottoms
Fonds antidérapants
Antislipbodems



⤴ Interiores exclusivos Personalizados
Exclusive Custom interiors
Intérieurs exclusifs Personnalisés
Persoonlijke exclusieve binnenzijden

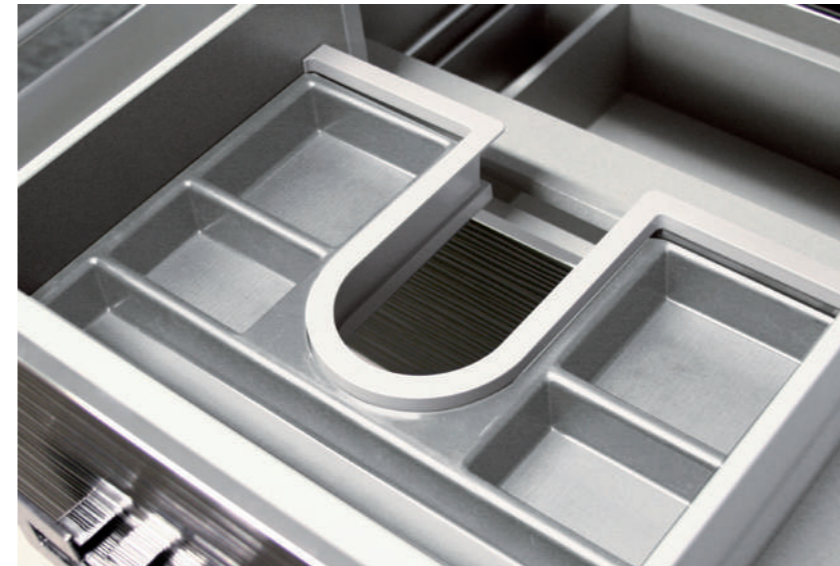

⤴ Bandeja portaobjetos
Storage tray
Plateau porte-objets
Opbergblad



⤴ Tapajuntas de esquinas en los cajones
Corner joint sealer
Cache-joint d'angle
Voegbedekking op de hoeken

Intouch

Mobiliario de Baño | Bathroom Furniture | Mobilier de Salle de Bains | Badkamermeubilair

Con 4 texturas:
Rosas, Semillas, Hilos
y Liso en 8 Colores.

With 4 textures:
Rosas, Semillas, Hilos and
Liso in 8 Colours.

Avec 4 textures :
Rosas, Semillas, Hilos et
Liso en 8 Couleurs.

Met 4 texturen:
Rosas, Semillas, Hilos en
Liso in 8 Kleuren.

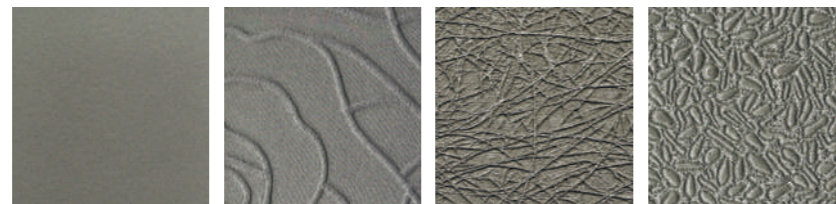

LISO
6N Gris In

ROSAS
6N Gris In

HILOS
6N Gris In

SEMILLAS
6N Gris In

✓ LISO
6N Gris In



ROSAS ✓
6N Gris In



HILOS
6N Gris In

SEMILLAS ✓
6N Gris In





Intouch

Mobiliario de Baño | Bathroom Furniture
 Mobilier de Salle de Bains | Badkamermeubilair

Colores, colores,
 colores...!!

Colours, colours,
 colours...!!

Couleurs, couleurs,
 couleurs...!

Kleuren, kleuren,
 kleuren...!!

COLORES | COLOURS
 COULEURS | KLEUREN

-
- 0N Blanco IN
 - 1N Champán IN
 - 2N Crema IN
 - 3N Caldera IN
 - 4N Antracita IN
 - 5N Negro IN
 - 6N Gris IN
 - 7N Morado IN



Intouch

Mobiliario de Baño | Bathroom Furniture | Mobilier de Salle de Bains | Badkamermeubilair

Compact or...

Composiciones previamente configuradas
Previously configured arrangements
Compositions déjà assemblées
Reeds bestaande samenstellingen



Mueble con zócalo 3 cajones
Floor standing vanity unit 3 drawers
Meuble sur socle 3 tiroirs
Meubel met plint en 3 lades

+



Encimera integrada curva Intouch
Intouch curved built-in vanity top
Plan intégré courbe Intouch
Gebogen ingebouwd bovenblad Intouch



Mueble 2 cajones recto suspendido
Straight wall hung vanity unit 2 drawers
Meuble 2 tiroirs droit suspendu
Recht ophangmeubel met 2 lades

+



Encimera integrada recta Intouch
Intouch straight built-in vanity top
Plan intégré droit Intouch
Recht ingebouwd bovenblad Intouch

Modular

Composiciones compuestas por varios módulos
Arrangements comprising several modules
Compositions plusieurs modules
Samenstellingen die uit verschillende modules bestaan



2 Muebles zócalo con puertas
2 floor standing vanity units with doors
2 Meubles sur socle avec portes
2 Meubels met plint met deuren

+



Coqueta 3 cajones
Vanity cabinet 3 drawers
Coiffeuse 3 tiroirs
Toilettafel met 3 lades

+



2 Muebles zócalo con puertas
2 floor standing vanity units with doors
2 Meubles sur socle avec portes
2 Meubels met plint met deuren

+



Encimera integrada para mueble recto
Built-in vanity top for straight unit
Plan intégré pour meuble droit
Ingebouwd bovenblad voor recht meubel

OTROS EJEMPLOS | Other examples | Autres exemples |
Andere voorbeelden



Mueble recto 2 puertas +
Coqueta 2 cajones
Straight vanity unit 2 doors +
vanity cabinet 2 drawers
Meuble droit 2 portes +
Coiffeuse 2 tiroirs
Recht meubel met 2 deuren +
Toilettafel met 2 lades



Mueble recto 3 cajones +
Coqueta 3 cajones
Straight vanity unit 3 drawers +
vanity cabinet 3 drawers
Meuble droit 3 portes +
Coiffeuse 3 tiroirs
Recht meubel met 3 lades +
Toilettafel met 3 lades

Intouch

Mobiliario de Baño | Bathroom Furniture | Mobilier de Salle de Bains | Badkamermeubilair



Mueble 2 cajones
Vanity unit 2 drawers
Meuble 2 tiroirs
Meubel met 2 lades

L 1200 X P 432 X H 570



Encimera integrada curva Intouch
Intouch curved built-in vanity top
Plan intégré courbe Intouch
Gebogen ingebouwd bovenblad
Intouch

L 1210 X P 435 X H 16



Espejo enmarcado con moldura
Framed mirror with moulding
Miroir encadré avec moulure
Spiegel met omlijsting

L 1200 X P 24 X H 700



LISO
6N Gris IN



Módulo con ruedas curvo
Curved sideboard on wheels
Module courbe à roulettes
Gebogen module met wieltjes

L 1200 X P 432 X H 433



Espejo auxiliar de aumento
Auxiliary magnifying mirror
Miroir auxiliaire grossissant
Vergrootspiegel

L 1200 X P 50 X H 600



Consola integrada curva Intouch
Curved built-in Intouch console
Console intégrée courbe Intouch
Gebogen inbouwconsole Intouch

L 1210 X P 522 X H 100

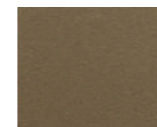

LISO
1N Champán IN



Intouch

Mobiliario de Baño | Bathroom Furniture | Mobilier de Salle de Bains | Badkamermeubilair

Conjuntos sencillos de consolas con espejos camerino
Light arrangements of consoles with dressing room furniture
Ensembles légers de consoles avec meubles loges
Lichte set consoles met spiegelkasten



Consola integrada curva Intouch
Curved built-in Intouch console
Console intégrée courbe Intouch
Gebogen inbouwconsole Intouch

L 1210 X P 522 X H 100



Espejo camerino
Mirror cabinet
Miroir loge
Gebogen console

L 1200 X P 130 X H 700



Colgable con puerta
Wall vanity unit with door
Élément à suspendre avec porte
Hangkast met deur

L 450 X P 200 X H 700

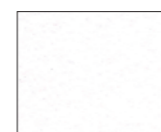

LISO
0N Blanco IN





Intouch

Mobiliario de Baño | Bathroom Furniture
Mobilier de Salle de Bains | Badkamermeubilair



Mueble 2 cajones recto suspendido
Straight wall hung vanity unit 2 drawers
Meuble 2 tiroirs droit suspendu
Recht ophangmeubel met 2 lades

L 1100 X P 480 X H 570



Encimera integrada recta Intouch
Intouch straight built-in vanity top
Plan intégré droit Intouch
Recht ingebouwd bovenblad Intouch

L 1110 X P 480 X H 16



Espejo enmarcado textura
Mirror framed texture
Miroir encadré texture
Spiegel omlijst textuur

L 1000 X P 24 X H 700

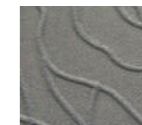

ROSAS
6N Gris IN



Intouch

Mobiliario de Baño | Bathroom Furniture | Mobilier de Salle de Bains | Badkamermeubilair



Mueble con zócalo 3 cajones
Floor standing vanity unit 3 drawers
Meuble sur socle 3 tiroirs
Meubel met plint en 3 lades

L 1200 X P 432 X H 850



Encimera integrada curva Intouch
Intouch curved built-in vanity top
Plan intégré courbe Intouch
Gebogen ingebouwd bovenblad Intouch

L 1210 X P 435 X H 16



Espejo con textura
Textured mirror
Miroir texturé
Spiegel met textuur

L 1000 X P 24 X H 700



Balda Liso
Plain shelf
Étagère unie
Legplank effen

L 400 X P 130 X H 12



Toallero
Towel holder
Porte-serviettes
Handdoekrek

L 400 X P 130 X H 12



ROSAS
1N Champán IN

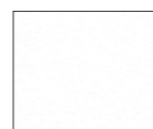

LISO
0N Blanco IN



Mueble suspendido con puertas
Wall hung vanity unit with doors
Meuble suspendu avec portes
Ophangmeubel met deuren

L 1000 X P 480 X H 570



Encimera sobremesa recta Intouch
Intouch straight vanity top
Plan à poser droit Intouch
Rechthoekig bovenblad in opbouwmodel Intouch

L 1000 X P 480 X H 570



Lavabo sobremesa IOTA
IOTA table top wash basin
Vasque à poser IOTA
Wastafel opbouwmodel IOTA

L 660 X P 335 X H 110



Espejo Teja textura
Mirror Teja texture
Miroir texture Teja
Spiegel Teja textuur

L 900 X P 75 X H 700



Columna 4 cajones
High cabinet 4 drawers
Colonne 4 tiroirs
Kolomkast met 4 lades

L 900 X P 75 X H 700



Intouch

Mobiliario de Baño | Bathroom Furniture | Mobilier de Salle de Bains | Badkamermeubilair



Mueble suspendido de 2 cajones
Wall hung vanity unit with 2 drawers
Meuble suspendu à 2 tiroirs
Ophangmeubel met 2 laden

L 1000 X P 480 X H 570



Encimera integrada recta Intouch
Intouch straight built-in vanity top
Plan intégré droit Intouch
Recht ingebouwd bovenblad Intouch

L 1010 X P 480 X H 16



HILOS
0N Blanco IN



Espejo moldura Liso
Mirror with smooth moulding
Miroir moulure unie
Spiegel met effen omlijsting

L 1000 X P 24 X H 700



Columna Cajones
High cabinet Drawers
Colonne Tiroirs
Kolomkast met Lades

L 450 X P 335 X H 966



Columna puerta
High cabinet door
Colonne porte
Kolomkast met deur

L 450 X P 335 X H 966



Intouch

Mobiliario de Baño | Bathroom Furniture | Mobilier de Salle de Bains | Badkamermeubilair

Muebles, auxiliares y complementos conjuntados.
 Vanity units, auxiliary elements and matched accessories.
 Meubles, compléments et compléments assemblés.
 Meubels, hulpmeubels en bijbehorende accessoires.



Mueble suspendido 1 cajón curvo
 Wall hung curved vanity unit 1 drawer
 Meuble suspendu 1 tiroir courbe
 Gebogen hangmeubel met 1 lade

L 1000 X P 432 X H 337



Encimera sobremesa curva Intouch
 Intouch curved vanity top
 Plan à poser courbe Intouch
 Gebogen bovenblad opbouwmodel Intouch

L 1010 X P 435 X H 16



Lavabo sobremesa Omicron
 Omicron table top wash basin
 Vasque à poser Omicron
 Wastafel opbouwmodel Omicron

L 600 X P 320 X H 110



Colgable
 Wall vanity unit
 Élément à suspendre
 Hangkast

L 450 X P 200 X H 700



Espejo moldura Liso
 Mirror with moulding Liso
 Miroir moulure Liso
 Spiegel met omlijsting Liso

L 1000 X P 24 X H 700

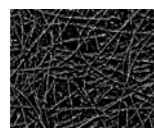

HILOS
 5N Negro IN





Intouch

Mobiliario de Baño | Bathroom Furniture |
 Mobilier de Salle de Bains | Badkamermeubilair



2 Muebles suspendidos con puertas
 2 Wall hung vanity units with doors
 2 Meubles suspendus avec portes
 2 ophangmeubels met deuren

L 750 X P 480 X H 570



Encimera bajoplano recta Intouch
 Intouch straight undermount vanity top
 Plan à encastrer droit Intouch
 Rechtt Bovenblad onderhangend Intouch

Lavabo bajoplano ZETA pequeño
 Small ZETA undermount
 wash hand basin
 Vasque à encastrer ZETA petite
 Wastafel onderhangend ZETA klein

L 1910 X P 480 X H 16

L 540 X P 335 X H 110



Coqueta 2 cajones
 Vanity cabinet 2 drawers
 Coiffeuse 2 tiroirs
 Toilettafel met 2 lades

L 400 X P 480 X H 570



Espejo Teja
 Mirror Teja
 Miroir Teja
 Spiegel Teja

L 1900 X P 75 X H 700

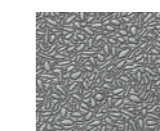

SEMILLAS
 6N Gris IN

Intouch

Mobiliario de Baño | Bathroom Furniture | Mobilier de Salle de Bains | Badkamermeubilair



2 Muebles zócalo con puertas
2 floor standing vanity units with doors
2 Meubles suspendus avec portes
2 Meubels met plint met deuren

L 750 X P 480 X H 850



Coqueta 3 cajones
Vanity cabinet 3 drawers
Coiffeuse 3 tiroirs
Toilettafel met 3 lades

L 400 X P 480 X H 850



Encimera bajoplano recta Intouch
Intouch straight undermount vanity top
Plan à encastrer droit Intouch
Recht Bovenblad onderhangend Intouch

L 1910 X P 480 X H 16



2 Lavabos bajoplano ZETA pequeño
2 Small Zeta undermount wash basins
2 Vasques à encastrer ZETA petite
2 Wastafel onderhangend ZETA klein

L 540 X P 335 X H 110



Espejo Teja
Mirror Teja
Miroir Teja
Spiegel Teja

L 1900 X P 75 X H 700



SEMILLAS
0N Blanco IN



2 Muebles suspendidos 2 cajones
2 Wall hung vanity units 2 drawers
2 Meubles suspendus 2 tiroirs
2 ophangmeubels met 2 lades

L 700 X P 432 X H 570



Encimera integrada curva Intouch
Intouch curved built-in vanity top
Plan intégré courbe Intouch
Gebogen ingebouwd bovenblad Intouch

L 710 X P 435 X H 16



2 Espejos moldura Liso
2 Mirrors with smooth moulding
2 Miroirs moulure unie
2 Spiegels met effen omlijsting

L 700 X P 24 X H 700

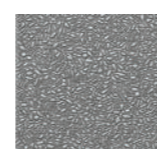

SEMILLAS
6N Gris IN



Intouch

Información Técnica | Technical Information | Informations Techniques | Technische Informatie

Dimensiones | Dimensions | Dimensions | Afmetingen



**Muebles Rectos
(con zócalo, 2 cajones y 1 cajón)**
Straight Furniture
(floor standing, 2 drawers and 1 drawer)
Meubles Droits
(avec socle, 2 tiroirs et 1 tiroir)
Rechte Meubels
(met plint, 2 lades en 1 lade)

A DE 700 A 1200 MM
H 337 / 570 / 850 MM
P 480 MM



**Muebles Curvos
(con zócalo, 2 cajones y 1 cajón)**
Curved Furniture
(floor standing, 2 drawers and 1 drawer)
Meubles Courbes
(avec socle, 2 tiroirs et 1 tiroir)
Gebogen Meubels
(met plint, 2 lades en 1 lade)

A DE 700 A 1200 MM
H 337 / 570 / 850 MM
P 432 MM



SUSPENDIDOS
WALL HUNG
SUSPENDUS
WANDMONTAGE



CON ZÓCALO
FLOOR STANDING
SUR SOCLE
MET SOKKEL

Colgables y Columnas | Wall vanity units and High Cabinets | Éléments à suspendre et Colonnes | Hangkasten en Kolomkasten



Columnas con cajones
High cabinets with drawers
Colonnes à tiroirs
Kolomkasten met lades



Colgables puertas
High cabinets with doors
Éléments suspendus avec portes
Hangkasten met deuren

Auxiliares con ruedas | Auxiliary elements with wheels | Compléments avec roulettes | Hulpmeubels met wieltjes



Rectos
Straight
Droits
Recht

Curvos
Curved
Courbes
Gebogen

Baldas & Toalleros | Shelves & Towel holders | Shelves & Towel holders | Legplanken & handdoekrekken



Baldas
Shelves
Étagères
Legplanken

Toalleros
Towel holders
Porte-serviettes
Handdoekrekken

Espejos | Mirrors | Miroirs | Spiegels



Espejo camerino
Mirror cabinet
Miroir loge
Spiegelkast



Espejo auxiliar de aumento
Auxiliary magnifying mirror
Miroir auxiliaire grossissant
Vergrootspiegel



Espejo enmarcado textura
Textured framed mirror
Miroir encadré textur
Spiegel met lijst met textuur



Espejo moldura Liso
Mirror with moulding Liso
Miroir moulure Liso
Spiegel met omlijsting Liso



Espejo Teja textura
Mirror Teja texture
Miroir texture Teja
Spiegel Teja textuur

Encimeras y Lavabos | Vanity tops and Wash basins | Encimeras y Lavabos | Plans et Vasques | Bovenbladen en Wastafels



Encimera integrada recta
Straight built-in vanity top
Plan intégré droit
Recht ingebouwd bovenblad



Encimera integrada curva
Curved built-in vanity top
Plan intégré courbe
Bovenblad ingebouwd gebogen



Encimera sobremesa recta
Straight tabletop vanity top
Plan à poser droit
Recht bovenblad opbouwmodel



Encimera bajo plano recta
Straight undermount vanity top
Plan à encastrer droit
Recht onderhangend bovenblad



Encimera sobremesa curva
Curved tabletop vanity top
Plan à poser courbe
Gebogen bovenblad opbouwmodel



Lavabo ZETA
ZETA wash basin
Vasque ZETA
Wastafel ZETA

Texturas & Colores | Textures and colours | Textures & Couleurs | Texturen & Kleuren

LISO



0N Blanco IN



2N Crema IN



1N Champán IN



6N Gris IN



4N Antracita IN



5N Negro IN



3N Caldera IN



7N Morado IN

ROSAS



0N Blanco IN



2N Crema IN



1N Champán IN



6N Gris IN



4N Antracita IN

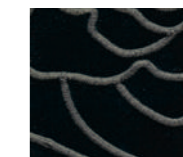

5N Negro IN

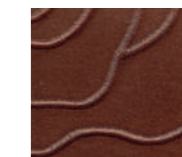

3N Caldera IN



7N Morado IN

HILOS



0N Blanco IN



2N Crema IN

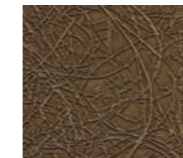

1N Champán IN

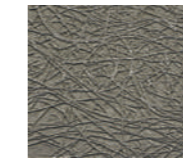

6N Gris IN



4N Antracita IN

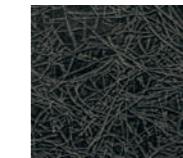

5N Negro IN

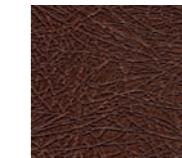

3N Caldera IN

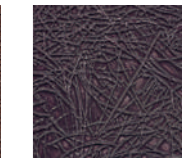

7N Morado IN

SEMILLAS

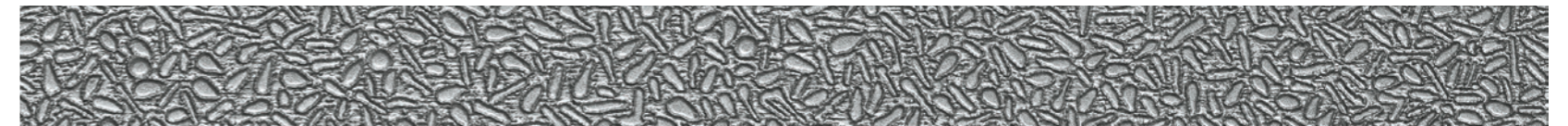

0N Blanco IN

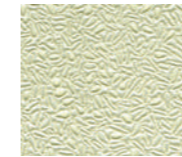

2N Crema IN

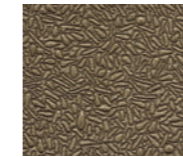

1N Champán IN

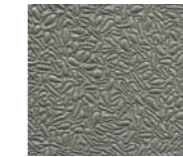

6N Gris IN

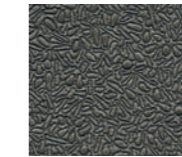

4N Antracita IN



5N Negro IN



3N Caldera IN

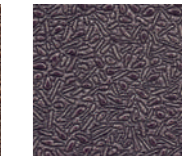

7N Morado IN

Vivaldi

Mobiliario de Baño | Bathroom Furniture | Mobilier de Salle de Bains | Badkamermeubilair

ESTILO CLÁSICO | CLASSICAL STYLE | STYLE CLASSIQUE | KLASSIEKE STIJL

Ondas
Ondas
Ondas
Ondas

Flores
Flores
Flores
Flores

Información Técnica
Technical Information
Informations Techniques
Technische Informatie

P.
234, 235,
240, 241,

P.
234, 235, 236,
237, 238, 239

P.
242, 243

Vivaldi

Mobiliario de Baño | Bathroom Furniture | Mobilier de Salle de Bains | Badkamermeubilair

Diseño clásico
con estilo.
Detalles singulares.

Classical design
with style.
Singular details.

Design classique
avec du style.
Finitions uniques.

Klassiek ontwerp
met stijl.
Aparte details.



Vivaldi

Mobiliario de Baño | Bathroom Furniture |
Mobilier de Salle de Bains | Badkamermeubilair

2 Texturas.
Flores y Ondas
en 4 colores.

2 Textures.
Flores and Ondas
in 4 colours.

2 Textures.
Flores et Ondas
en 4 couleurs.

2 Texturen.
Flores en Ondas
in 4 kleuren.



FLORES
Blanco

ONDAS
Blanco

✓ FLORES
Blanco



✓ FLORES
Crema



✓ FLORES
Plata



✓ FLORES
Negro



∧ ONDAS
Blanco

∧ ONDAS
Marrón

∧ ONDAS
Oro

∧ ONDAS
Plata

Vivaldi

Mobiliario de Baño | Bathroom Furniture |
Mobilier de Salle de Bains | Badkamermeubilair



Mueble 1 cajón
Vanity unit 1 drawer
Meuble 1 tiroir
Meubel met 1 Lade

L 1000 X P 500 X H 880

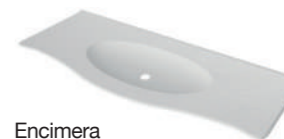

Encimera
Vanity tops
Plan
Bovenblad

L 1000 X P 510 X H 12



Espejo enmarcado inglete
Mitred frame mirror
Miroir encadré a onglet
Omlijste spiegel facet

L 600 X F 50 X H 900



Columna con puerta
High cabinet with door
Colonne avec porte
Kolomkast met deur

L 500 X P 350 X H 1270

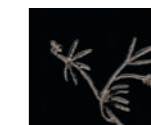

FLORES
F5 Negro

Vivaldi

Mobiliario de Baño | Bathroom Furniture | Mobilier de Salle de Bains | Badkamermeubilair

Otros usos, como en un hall de entrada

Other uses, such as in an entrance hall
Autres usages, comme pour une entrée
Andere gebruiken, zoals in de inkomhal

VIVALDi es una colección versátil que puede reconvertirse en un uso alternativo cuando se prescinde del lavabo, se convierte en un mueble de hall de entrada.

VIVALDi is a versatile collection that can be re-purposed for an alternative use when the wash basin is not used, to become a piece of furniture for the entrance hall.

VIVALDi est une collection polyvalente qui se transforme pour une nouvelle utilisation. Il suffit d'enlever la vasque pour le transformer en un meuble d'appoint dans l'entrée.

VIVALDi is een veelzijdige collectie die een alternatief gebruik biedt als meubel in de inkomhal, wanneer men ze niet langer als wastafel gebruikt.



Mueble 2 cajones
Vanity unit 2 drawers
Meuble 2 tiroirs
Meubel met 2 lades

L 1200 X P 500 X H 880



Espejo enmarcado inglete
Mitre frame mirror
Miroir encadré à onglet
Omlijste spiegel facet

L 600 X P 50 X H 900



Encimera
Vanity tops
Plan
Bovenblad

L 1200 X P 510 X H 12



FLORES
F3 Blanco



Mueble 1 cajón sin lavabo
Vanity unit 1 drawer without wash basin
Meuble 1 tiroir sans vasque
Meubel met 1 lade zonder wastafel

L 1000 X P 500 X H 880



FLORES
F2 Crema



Encimera
Vanity tops
Plan
Bovenblad

L 1000 X P 510 X H 12



Espejo enmarcado inglete
Mitre frame mirror
Miroir encadré à onglet
Omlijste spiegel facet

L 600 X P 50 X H 900



Vivaldi

Mobiliario de Baño | Bathroom Furniture | Mobilier de Salle de Bains | Badkamermeubilair



Mueble 2 cajones
Vanity unit 2 drawers
Meuble 2 tiroirs
Meubel met 2 lades

L 1000 X P 500 X H 880



Espejo enmarcado inglete
Mitre frame mirror
Miroir encadré a onglet
Omlijste spiegel facet

L 600 X P 50 X H 900



Encimera
Vanity tops
Plan
Bovenblad

L 1200 X P 510 X H 12



ONDAS
A3 Blanco



Mueble 1 cajón
Vanity unit 1 drawer
Meuble 1 tiroir
Meubel met 1 lade

L 1000 X P 500 X H 880

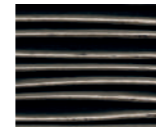

ONDAS
A8 Plata



Espejo enmarcado inglete
Mitre frame mirror
Miroir encadré a onglet
Omlijste spiegel facet

L 600 X P 50 X H 900



Encimera
Vanity tops
Plan
Bovenblad

L 1200 X P 510 X H 12



Vivaldi

Información Técnica | Technical Information | Information Technique | Technische Informatie

Dimensiones | Dimensions | Dimensions | Afmetingen



Mueble 1 Cajón
Vanity unit 1 Drawer
Meuble 1 tiroir
Meubel met 1 Lade

L 1000/1200
P 510
H 880

H 880 MM



Mueble 2 Cajones
Vanity unit 2 Drawers
Meuble 2 tiroirs
Meubel met 2 Lades

L 1000/1200
P 510
H 880

H 880 MM

L 1000/1200 MM

L 1000/1200 MM

Columnas con puerta | High cabinets with door
Colonnes avec porte | Kolomkasten met deur



L 500
P 350
H 1290

Columna con vitrina | High cabinet with display vanity unit
Colonne avec vitrine | Kolomkast met vitrine



L 500
P 350
H 1290

Espejos | Mirrors | Miroirs | Spiegels



Espejo enmarcado inglete horizontal
Horizontal mitred joint mirror
Miroir encadré biseau horizontal
Horizontale spiegel omlijst met verstek

L 900/1100
P 50
H 600



Espejo enmarcado inglete vertical
Vertical mitred joint mirror
Miroir encadré biseau vertical
Verticale spiegel omlijst met verstek

L 600
P 50
H 900

Encimeras y Lavabos | Vanity tops and Wash basins |
Plans et Vasques | Bovenbladen en Wastafels

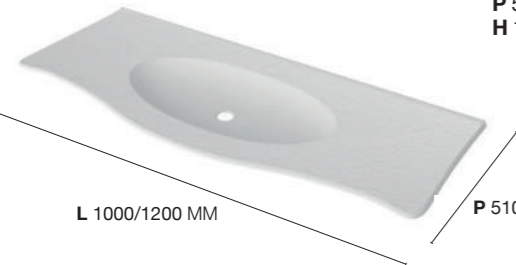

L 1000/1200
P 510
H 12

L 1000/1200 MM

P 510 MM

Texturas & Colores | Textures and colours | Textures & Couleurs | Texturen & Kleuren

FLORES



F3 Blanco



F2 Crema

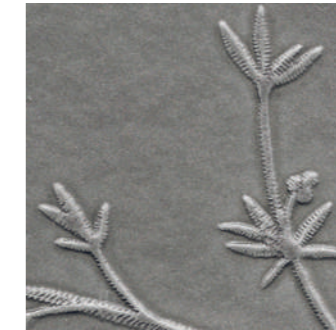

F8 Plata



F5 Negro

ONDAS

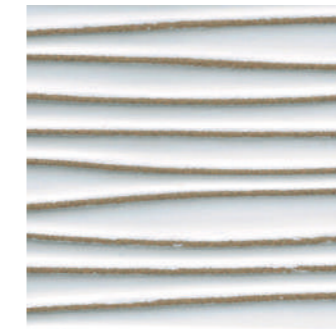

A3 Blanco

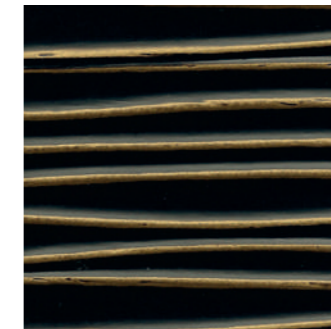

A7 Oro

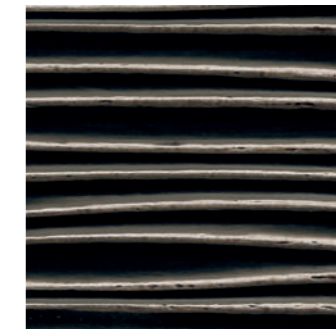

A8 Plata

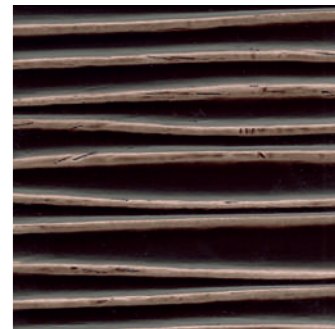

A1 Marrón

Lavabos&Consolas

Wash basins & Consoles | Vasques & Consoles | Wastafels & Consoles

FONTANA



Fontana

Lavabos & Consolas | Wash basins & Consoles | Vasques & Consoles | Wastafels & Consoles

**TODAS LAS SOLUCIONES | ALL SOLUTIONS |
TOUTES LES SOLUTIONS | ALLE OPLOSSINGEN |**

Consolas rectas
Straight consoles
Consoles droites
Rechte consoles

P.

248, 249, 250,
254, 256, 257,
258, 259

Consolas curvas
Curved consoles
Consoles courbes
Gebogen consoles

P.

248, 249, 251,
260, 261

Lavabos sobremesa
Table top wash basins
Vasques à poser
Wastafels opbouwmodel

P.

248, 249, 252,
262, 261, 263,
264, 265, 266,
267

Información Técnica
Technical Information
Informations Techniques
Technische Informatie

P.

268, 269

Fontana

Lavabos & Consolas | Wash basins & Consoles |
Vasques & Consoles | Wastafels & Consoles

3 Tipos de producto
para todas las
soluciones necesarias:
consolas rectas, curvas y
lavabos.

3 types of wash basin
for all the necessary
solutions: straight, curved
consoles and wash basins.

3 Types de vasque
pour toutes les
solutions nécessaires :
consoles droites, courbes
et vasques.

3 Soorten wastafels
voor alle nodige oplossingen:
rechte en gebogen consoles
en wastafels.



Ⓥ Lavabos Sobremesa
Table top wash basins
Vasques à Poser
Wastafels Opbouwmodel

Ⓛ Consolas Rectas
Straight Consoles
Consoles Droites
Rechte Consoles

Ⓜ Consolas Curvas
Curved Consoles
Consoles Courbes
Gebogen Consoles

Fontana

Lavabos & Consolas | Wash basins & Consoles | Vasques & Consoles | Wastafels & Consoles

Consolas rectas

Straight consoles | Consoles droites | Rechte consoles

Consola recta lavabo integrado
Straight console built-in wash basin
Console droite vasque intégrée
Rechte console ingebouwde wastafel



Consola recta lavabo sobremesa
Straight console tabletop wash basin
Console droite vasque à poser
Rechte console wastafel opbouwmodel



Consola recta para lavabo bajo plano
Straight console for undermount wash basin
Console droite pour vasque à encastrer
Rechte console voor onderhangende wastafel



Consola recta lavabo integrado doble
Straight console built-in double wash basin
Console droite vasque intégrée double
Rechte console ingebouwde dubbele wastafel



Consola recta lavabo sobremesa doble
Straight console tabletop double wash basin
Console droite vasque à poser double
Rechte console dubbele wastafel opbouwmodel



Consola recta para 2 lavabos bajo plano
Straight console for 2 undermount wash basins
Console droite pour 2 vasques à encastrer
Rechte console voor 2 onderhangende wastafels



Consola recta lavabo integrado desplazado
Straight console built-in offset wash basin
Console droite vasque intégrée décalée
Rechte console ingebouwde niet-gecentreerde wastafel



Consola recta lavabo sobremesa desplazado
Straight console tabletop offset wash basin
Console droite vasque à poser décalée
Rechte console niet-gecentreerde wastafel opbouwmodel



Consola recta para lavabo bajo plano desplazado
Straight console for undermount offset wash basin
Console droite pour vasque à encastrer décalée
Rechte console voor onderhangende niet-gecentreerde wastafel



Consolas curvas

Curved consoles | Consoles courbes | Gebogen consolen

Consola curva con lavabo integrado
Curved console with built-in wash basin
Console courbe avec vasque intégrée
Gebogen console met ingebouwde wastafel



Consola curva lavabo sobremesa
Curved console tabletop wash basin
Console courbe vasque à poser
Gebogen console wastafel opbouwmodel



Fontana

Lavabos & Consolas | Wash basins & Consoles | Vasques & Consoles | Wastafels & Consoles

Lavabos

Wash hand bassins | Vasques | Waschbecken



Lavabo STONE
STONE wash basin
Vasque STONE
Wastafel STONE



Lavabo KAPPA
KAPPA wash basin
Vasque KAPPA
Wastafel KAPPA



Lavabo SIGMA
SIGMA wash basin
Vasque SIGMA
Wastafel SIGMA



Lavabo GAMMA
GAMMA wash basin
Vasque GAMMA
Wastafel GAMMA



Lavabo BETA
BETA wash basin
Vasque BETA
Wastafel BETA



Lavabo OMICRON
OMICRON wash basin
Vasque OMICRON
Wastafel OMICRON



Lavabo IOTA
IOTA wash basin
Vasque IOTA
Wastafel IOTA



Lavabo ALFA
ALFA wash basin
Vasque ALFA
Wastafel ALFA



Fontana

Lavabos & Consolas | Wash basins & Consoles | Vasques & Consoles | Wastafels & Consoles

3 Texturas: Pizarra, Liso y Stucco

3 Textures:
Pizarra, Liso
and Stucco

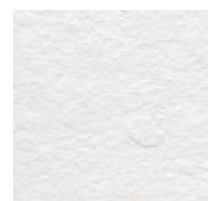

PIZARRA
0P Bianco

3 Textures:
Pizarra, Liso et
Stucco

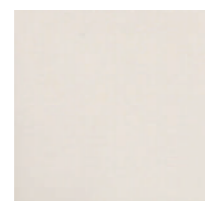

LISO
0P Bianco

3 Textures:
Pizarra, Liso en
Stucco

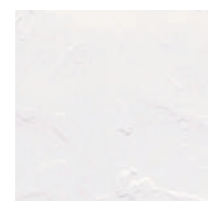

STUCCO
0P Bianco

9 Colores sólidos y 6 Nature que ofrecen más de 60 posibilidades.

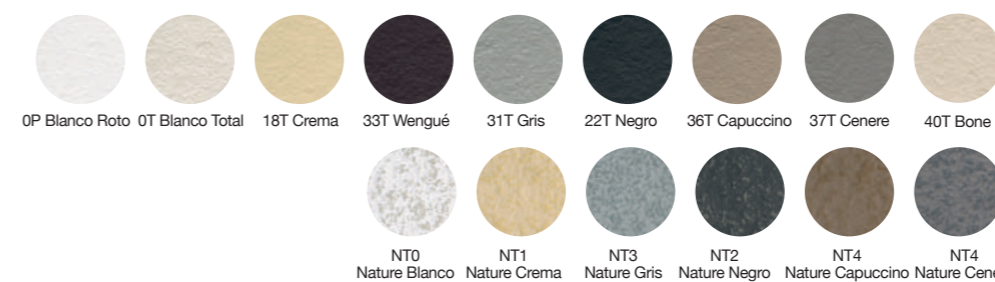

Solid and nature colours
that offer more than 60
possibilities.

Couleurs Uniformes et
nature offrant plus de 60
possibilités.

Solide en nature kleuren
die meer dan 60
mogelijkheden bieden.



Colores personalizados RAL
RAL custom colours
Couleurs personnalisées RAL
Gepersonaliseerde RAL-kleuren

Fontana

Lavabos & Consolas | Wash basins & Consoles | Vasques & Consoles | Wastafels & Consoles



Consola recta lavabo integrado
Straight console built-in wash basin
Console droite vasque intégrée
Rechte console ingebouwde wastafel

L 2010 X P 480 X H 100



PIZARRA
OP Blanco Total



Consola recta lavabo integrado desplazado
Straight console built-in offset wash basin
Console droite vasque intégrée décalée
Rechte console ingebouwde niet-gecentreerde wastafel

L 1610 X P 480 X H 100



LISO
OP Blanco Total



Consola recta lavabo bajoplano doble
Straight console undermount double wash basin
Console droite vasque à encastrer double
Rechte console wastafel dubbel onderhangend

L 2010 X P 480 X H 100



Fontana

Lavabos & Consolas | Wash basins & Consoles | Vasques & Consoles | Wastafels & Consoles



Consola recta lavabo integrado
Straight console built-in wash basin
Console droite vasque intégrée
Rechte console ingebouwde wastafel

L 1200 X P 480 X H 100



Consola recta lavabo bajoplano doble
Straight console built-in double wash basins
Console droite vasque à encastrier double
Rechte console wastafel dubbel onderhangend

L 2010 X P 480 X H 100



Consola recta doble para lavabo sobremesa IOTA
Double straight console for IOTA tabletop wash basins
Console droite double pour vasque à poser IOTA
Rechte dubbele console voor wastafel opbouwmodel IOTA

L 1800 X P 480 X H 100

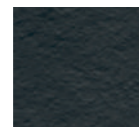

PIZARRA
22T Negro



Fontana

Lavabos & Consolas | Wash basins & Consoles | Vasques & Consoles | Wastafels & Consoles



Consola curva con lavabo integrado
Curved console with built-in wash basin
Console courbe avec vasque intégrée
Gebogen console met ingebouwde wastafel

L 1010 X P 494 X H 100



Consola curva con lavabo sobremesa OMICRON
Curved console with OMICRON tabletop wash basin
Console courbe avec vasque à poser OMICRON
Gebogen console met wastafel opbouwmodel OMICRON

L 1010 X P 494 X H 100



LISO
0P Blanco Total



Fontana

Lavabos & Consolas | Wash basins & Consoles | Vasques & Consoles | Wastafels & Consoles



Lavabo STONE
STONE wash basin
Vasque STONE
Wastafel STONE

L 545 X P 450 X H 70



Lavabo BETA
BETA wash basin
Vasque BETA
Wastafel BETA

L 545 X P 325 X H 83



PIZARRA
22T Negro

LISO
22T Negro

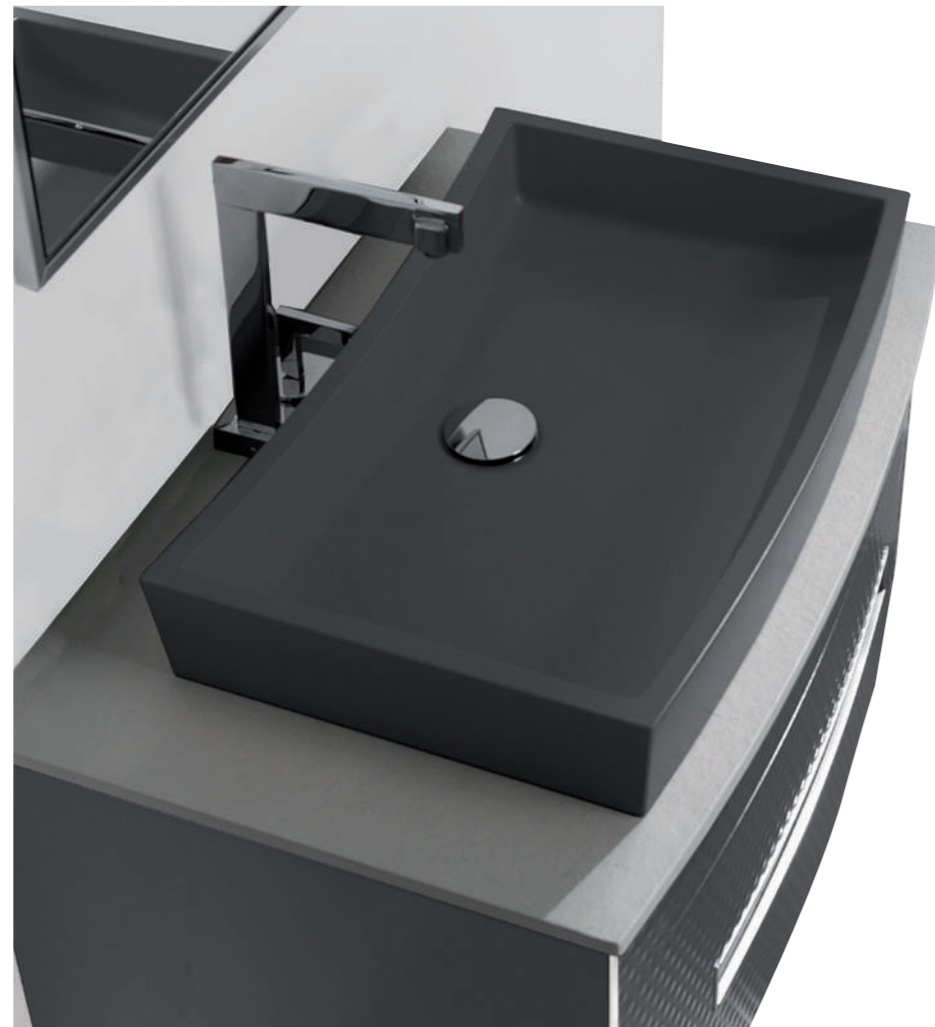

Fontana

Lavabos & Consolas | Wash basins & Consoles | Vasques & Consoles | Wastafels & Consoles



Lavabo KAPPA
KAPPA wash basin
Vasque KAPPA
Wastafel KAPPA

L 720 X P 430 X H 80



Lavabo GAMMA
GAMMA wash basin
Vasque GAMMA
Wastafel GAMMA

L 530 X P 285 X H 100



Lavabo SIGMA
SIGMA wash basin
Vasque SIGMA
Wastafel SIGMA

L 625 X P 350 X H 115

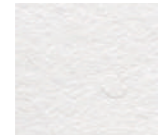

PIZARRA
0P Blanco Total



LISO
0P Blanco Total



Fontana

Lavabos & Consolas | Wash basins & Consoles | Vasques & Consoles | Wastafels & Consoles



Lavabo OMICRON
OMICRON wash basin
Vasque OMICRON
Wastafel OMICRON

L 600 X P 320 X H 110



Lavabo ALFA
ALFA wash basin
Vasque ALFA
Wastafel ALFA

L 667 X P 325 X H 83



Lavabo IOTA
IOTA wash basin
Vasque IOTA
Wastafel IOTA

L 540 X P 335 X H 110



LISO
31T Gris

LISO
22T Negro



Fontana

Información Técnica | Technical Information | Informations Techniques | Technische Informatie

Tipos de Lavabos & Encimeras | Types of Wash basins & Vanity tops | Types de Vasques & Plans | Soorten Wastafels & Bovenbladen

CONSOLAS RECTAS STRAIGHT CONSOLES CONSOLES DROITES RECHTE CONSOLES



DE 700 A 2000 MM
 > Pozas centradas, desplazadas y dobles.
 > Con posibilidad de toallero integrado.
 DE 700 A 2000 MM
 > Centred, offset and double drain holes.
 > Possibility of built-in towel holder.
 DE 700 A 2000 MM
 > Vasques centrées, décalées et doubles.
 > Avec possibilité de porte-serviettes intégré
 DE 700 À 2 000 MM.
 > Gecentreerde, niet-gecentreerde en dubbele waskommen.
 > Met optie van ingebouwd handdoekrek.

CONSOLAS CURVAS CURVED CONSOLES CONSOLES COURBES GEBOGEN CONSOLES



910 / 1010 / 1210 MM
Medidas disponibles
 910 / 1010 / 1210 MM
 Measurements available
 910 / 1010 / 1210 MM
 Mesures disponibles
 910 / 1010 / 1210 MM
 Beschikbare afmetingen

LAVABOS SOBREMESA TABLE TOP WASH BASINS VASQUES À POSER WASTAFELS OPBOUWMODEL



10 MODELOS
 > Diversidad de medidas
 > Formas varias: cuadrado, ovalado, etc.
 10 MODELS
 > Variety of sizes
 > Several shapes: square, oval etc.
 10 MODÈLES
 > Choix de dimensions
 > Formes variées : carrées, ovales, etc.
 10 MODELLEN
 > Verschillende maten
 > Verschillende vormen: vierkant, ovaal, enz.

Ejemplos de Consolas | Examples of Consoles | Exemples de Consoles | Voorbeelden van Consoles



Consola recta para lavabo bajo plano
 Straight console for undermount wash basin
 Console droite pour vasque à encastrer
 Rechte console voor onderhangende wastafel
 P. 45

Consola recta lavabo sobremesa
 Straight console for tabletop wash basin
 Console droite pour vasque à poser
 Rechte console voor wastafel opbouwmodel
 P. 45

Consola curva para lavabo sobremesa
 Curved console for tabletop wash basin
 Console courbe pour vasque à poser
 Gebogen console voor wastafel opbouwmodel
 P. 45

Consola recta lavabo integrado desplazado
 Straight console built-in offset wash basin
 Console droite vasque intégrée décalée
 Rechte console ingebouwde niet-gecentreerde wastafel
 P. 45

Consola recta lavabo integrado
 Straight console built-in wash basin
 Console droite vasque intégrée
 Rechte console ingebouwde wastafel
 P. 45

Ejemplos de Lavabos | Examples of Wash basins | Exemples de Vasques | Voorbeelden van Wastafels



Lavabo STONE
 STONE wash basin
 Vasque STONE
 Wastafel STONE
 P. 45

Lavabo KAPPA
 KAPPA wash basin
 Vasque KAPPA
 Wastafel KAPPA
 P. 45

LavaboOMICRON
 OMICRON wash basin
 Vasque OMICRON
 Wastafel OMICRON
 P. 45

Lavabo SIGMA
 SIGMA wash basin
 Vasque SIGMA
 Wastafel SIGMA
 P. 45

Lavabo GAMMA
 GAMMA wash basin
 Vasque GAMMA
 Wastafel GAMMA
 P. 45

Texturas & Colores | Textures and colours | Textures & Couleurs | Texturen & Kleuren

PIZARRA

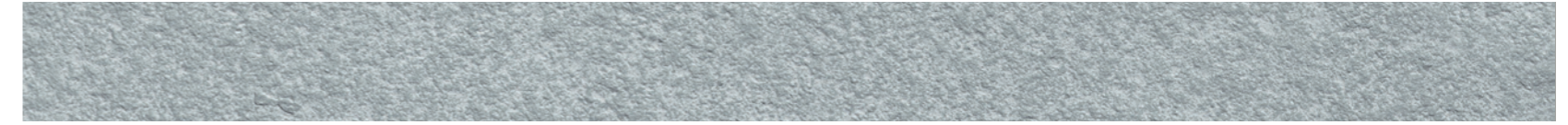

Colores Sólidos | Solid Colours | Couleurs Uniformes | Solide Kleuren



0T Blanco Roto 0P Blanco Total 18T Crema 33T Wengué 31T Gris 22T Negro 36T Capuccino 37T Cenere 40T Bone

Colores Nature | Nature Colours | Couleurs Nature | Nature Kleuren

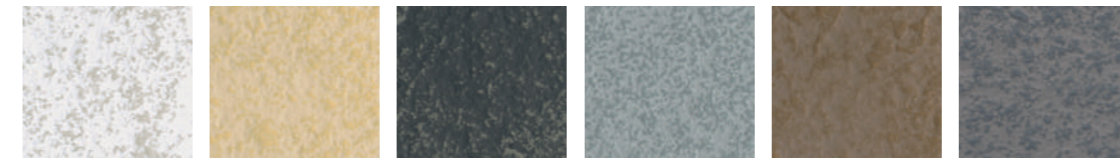

NT0 Nature Blanco NT1 Nature Crema NT2 Nature Negro NT3 Nature Gris NT4 Nature Capuccino NT5 Nature Cenere

LISO



0T Blanco Roto 0P Blanco Total 18T Crema 33T Wengué 31T Gris 22T Negro 36T Capuccino 37T Cenere 40T Bone

STUCCO



Colores Sólidos | Solid Colours | Couleurs Uniformes | Uni-Farben



0T Blanco Roto 0P Blanco Total 18T Crema 33T Wengué 31T Gris 22T Negro 36T Capuccino 37T Cenere 40T Bone

Colores Nature | Nature Colours | Couleurs Nature | Nature-Farben

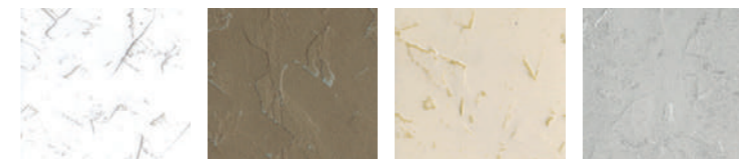

NT10 Nature Blanco K NT11 Nature Champán K NT12 Nature Crema K NT13 Nature Plata K

FIORA

Ctra. de Logroño, km.23.600
26300 Nájera (La Rioja) SPAIN
T (+34) 941 410 001
F (+34) 941 410 106
E fiora@fiora.es

DISEÑO DE PRODUCTO

Product Design | Conception de Produit | Productontwerp

Fiora

BRANDING

Branding | Branding | Branding

Cabo de Marcas

www.cabodemarcas.com

IMPRESIÓN

Printing | Impression | Druk

Otzarreta

www.otzarreta.com

FECHA DE EDICIÓN

Date published | Date de publication | Datum van publicatie

05/2017

Queda terminantemente prohibida la reproducción parcial e integral a través de cualquier proceso mecánico o fotográfico sin el permiso de la sociedad.

The partial or full reproduction by means of any mechanical or photographic process without the company's permission is strictly forbidden.

Toute reproduction totale ou partielle par quelque moyen que ce soit, mécanique ou photographique sans l'autorisation de la société est strictement interdite.

De gedeeltelijke of gehele reproductie via ongeacht welk mechanisch of fotografisch proces zonder de toestemming van de vennootschap is ten strengste verboden.

www.fiora.es

fiora

www.fiora.es

