

*Zehnder towel rails for
central heating, dual energy
and electric-only installations*

zehnder



zehnder *janda*



Tube-in-tube curved rail ladder radiator.
 23mm diameter horizontal tubes.
 30x35mm 'D' profile header tubes.

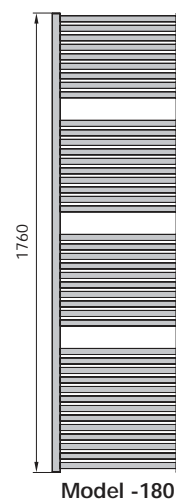
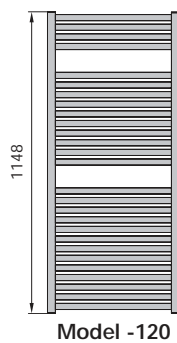
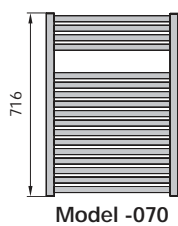

zehnder janda

Janda	Height (mm)	Width (mm)	50ΔT watts	60ΔT watts	Exponent	Allocated dual energy immersion heater
White						
JAB070-050	716	495	351	438	1.22	300
JAB120-050	1148	495	548	690	1.26	300
JAB180-050	1760	495	853	1075	1.27	600
JAB070-060	716	595	420	528	1.25	300
JAB120-060	1148	595	653	823	1.27	600
JAB180-060	1760	595	1013	1272	1.25	900
JAB120-075	1148	746	808	1015	1.25	600
JAB180-075	1760	746	1252	1572	1.25	1200
Chrome						
JABC070-050	716	495	251	314	1.23	n/a
JABC120-050	1148	495	396	496	1.24	300
JABC180-050	1760	495	603	756	1.24	600
JABC070-060	716	595	294	369	1.24	300
JABC120-060	1148	595	468	587	1.24	300
JABC180-060	1760	595	720	904	1.25	600
JABC120-075	1148	746	579	727	1.25	900
JABC180-075	1760	746	889	1117	1.25	900

Janda Electric White	Height (mm)	Width (mm)	Electric rating	Janda Electric Chrome	Height (mm)	Width (mm)	Electric rating
Factory fitted with a Novar immersion heater Class 1							
JAE-070-050/ND	716	495	300	JAEC-070-050/NS	716	495	n/a
JAE-120-050/ND	1148	495	300	JAEC-120-050/NS	1148	495	300
JAE-180-050/ND	1760	495	600	JAEC-180-050/NS	1760	495	600
JAE-070-060/ND	716	595	300	JAEC-070-060/NS	716	595	300
JAE-120-060/ND	1148	595	600	JAEC-120-060/NS	1148	595	300
JAE-180-060/ND	1760	595	900	JAEC-180-060/NS	1760	595	600
JAE-120-075/ND	1148	746	600	JAEC-120-075/NS	1148	746	900
JAE-180-075/ND	1760	746	1200	JAEC-180-075/NS	1760	746	900

Maximum test pressure: 15 bar

Maximum operating pressure: 11.5 bar

For information on alternative and dual energy immersion heater options, please refer to the back page.

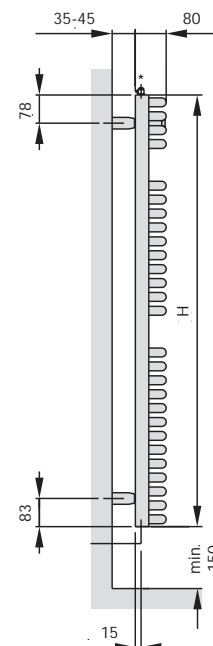
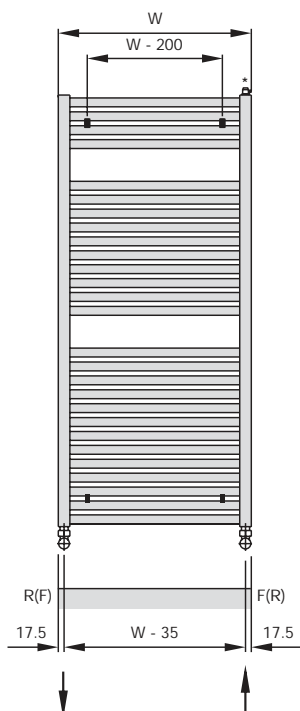

F = Flow
R = Return
* = Air Vent

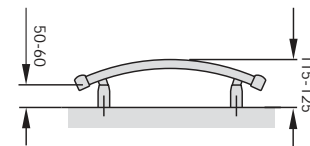

Dual energy installations

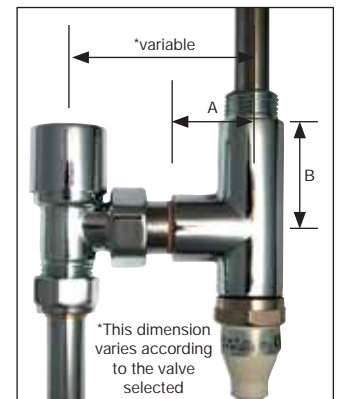

	Dim A	Dim B
DBM (short T-piece)	22mm	17mm
Novar (T-piece as above)	30mm	42mm
Simple Immersion (T-piece as above)	30mm	42mm

zehnder *electric immersion heater options*

Zehnder's oil-filled electrical radiators are supplied with the immersion heater factory fitted.

Dual energy installations can be supplied to order with a Novar, DBM immersion heater with controls, or a simple immersion heater element without controls. They are supplied with a T-piece as standard.



The electronic **Novar** (300w/600w/900w, 1200w IP65 Class 1) has a safety cut-out facility. The standard model has a control switch with 2 fixed temperature settings (50 deg.C or 70 deg.C), a 3-hour timer (70 deg.C) and off.

Electric only applications: Factory fitted to the Universal and Janda ranges. Available as self-fit for dual-energy applications. (SPECIAL APPLICATION OPTIONS AVAILABLE TO ORDER)



The **simple immersion** rod (300w/600w/900w, 1200w, IP55, Class 1) is a mechanical heating device with a thermo-fuse. It has no manual controls.

Electric only applications: Can be factory fitted to order on the Toga range, but minimum order quantities apply. Available as self-fit for dual-energy applications.



The electronic **DBM** (200w/300w/500w/600w/750w/900w, IP44, Class 1) with its safety cut-out facility has 2 fixed temperature settings (45 deg.C or 70 deg.C), a 2-hour programmable timer and an on/off control switch. (The DBM control is white or chrome dependant on the radiator finish.)

Electric only applications: Factory fitted to the Toga range. Available as self-fit for dual-energy applications.

Immersion heaters on electric towel rails are fitted in the right-hand header as standard, but can be fitted in the left hand header on request.

For dual energy operation, immersion heaters should be fitted on the return. The central heating and electrical options should never be used simultaneously. This will damage the unit and invalidate the warranty. In additions, the conflicting heat sources will prevent the correct circulation of the liquid, potentially forming damaging hot-spots.

Instructions for dual energy operation:

Summer use:

Switch off the central heating and vent the radiator.
Close the flow valve (only)
Activate the immersion heater as required.

Winter Use:

De-activate the immersion heater
Open the flow valve
The central heating will heat the rails

