

First choice, for your first thing

The Triton Shower Collection



Design, function and reliability

At Triton, we're proud to be known as 'The UK's Shower company'. Having produced expertly engineered, innovative shower designs for the British public since 1975, we've been an important part of your first thing routine for over 40 years.

We want that morning routine to be a great experience, which is why every Triton shower is expertly designed and rigorously tested.

That way, we've done absolutely everything we can to provide a reliable, enjoyable product that works perfectly every time. All of our showers are guaranteed against mechanical and electrical defects from the day they're fitted, with extra cover available for up to five years too.

Finally: style. We Brits are a fashionable bunch, which is why we take care in producing stylish, eye-pleasing showers for every price range. No matter what your budget, your shower will be a looker!



Reasons to choose Triton



1. Full Parts & Labour Guaranteed

All our models are individually tested. Every shower is backed by a full Triton parts & labour guarantee against mechanical or electrical defects.



2. Trusted Triton Service

Once you've bought a Triton product, it doesn't stop there. Our service team of fully trained telephone advisors and engineers provide you with help and support throughout its lifetime, to keep your shower running when you need it.



3. Designed & Built in Britain

We have been at the heart of the nation's bathrooms for more than 40 years. Today, our name stands for the best of British design, engineering and service. We are proud to be the UK's leading shower brand, trusted by the trade and homeowners alike.



4. Easy to Install

All Triton models are expertly engineered and rigorously tested to ensure the highest levels of quality and performance. Our showers are also designed with ease of installation in mind for quick, hassle-free fitting.



5. Next Day Delivery

Exceptional customer service, providing next day delivery.



6. Fit and forget

The Nation's leading brand will back you up so you can simply fit and forget.

Connect with Triton Showers at www.tritonshowers.co.uk or on  



Contents

See you first thing Britain	4 – 5
Shower range overview	6 – 7
Digital showers	8 – 11
Mixer showers	12 – 24
Electric showers	25 – 33
Power showers	34 – 35
Care showers	36 – 45
Shower accessories	46 – 47
Help me choose	48 – 49
Installer Guide	50 – 55
Specifications	56 – 63

Introduction

See you first thing Britain

Which shower type are you?

In Britain, a shower is like a cup of tea – everyone takes it differently. You've got the singers who love to linger, the go-getters who are out before they've got much wetter, the exotic lot who like it hot and many, many more.

Having been around since 1975, we understand and celebrate these differences, which is why we produce so many different shower types. Each part of our range has its own unique benefits which are bound to make first thing a time to look forward to.

The only question is – which shower type are you...?



The first-thing philosopher

This lot are in the shower for ages, but they don't seem to accomplish much. That's because they're too busy reflecting on the more important questions in life, like 'why are we here?' and 'do I look good in shorts?' Ok, so maybe their hair isn't always washed, but their minds are well and truly cleansed. If you're a philosopher, you're going to want to spend more time thinking and less time worrying – which is why our comprehensive product guarantees are perfect. And with expert engineers on standby should you need them, you can worry about more important things.



The daybreak diva

Maybe you're a Diva. You know the type; the type who likes to sing in the shower. Where most people see a shampoo bottle, the Diva sees a microphone, or a tambourine, or maybe even a Grammy Award. If you're a Diva, you're all about a great performance, which is exactly what you get with a Triton shower. They'll hit the right notes every morning – even if you don't!



The early-morning escapist

Escapists are busy people. Maybe they're a mum of four or a workaholic or both! Whatever they do, they look to their shower for a little moment of calm.

A few minutes to spend on themselves, and themselves alone. We think they deserve that – don't you? If you're an Escapist, our showers are exactly what you need. They're easy to install, use and maintain, and bound to keep those stress-levels down!



The sun-up survivor

Survivors stay up late playing too many video games, and it puts them on edge. So much so, they start losing their grip on reality. 'Is today Monday?', they wonder, 'or is it the day of reckoning, where the undead claim the world for their own?'. If you're a survivor, a nice, relaxing shower is a real must, preparing you for whatever first thing may bring.



The reluctant riser

These types really aren't morning people. They'll do anything for an extra few minutes in bed, including sleeping through multiple alarms. For reluctant risers, a shower needs to be easy, reliable and fast - which is where Triton comes in. Getting your shower just the way you want it quickly is our aim, so your first thing starts off on the right foot. After all, these guys are already late for work as it is!

The Triton shower range explained

Digital Mixer Showers

Triton digital mixer showers offer an unbeatable combination of smart state of the art technology, stylish choices and ease of installation with total control over your showering experience.

Mixer Showers

Mixer showers draw from both hot and cold water supplies which are readily available via a combi boiler or large capacity hot water cylinder. The water is then mixed within the valve.

Taps

Our selective range of taps have been designed to fully coordinate with our key mixer ranges, enabling you to style your bathroom or en-suite with ease.

Electric Showers

Electric showers draw on cold water supply and heat the water on demand, making electric showers energy efficient class A. Choose a higher kilowatt rating for better flow performance.

Pumped Electric Showers

Pumped electric showers heat the water on demand and have a built in pump to boost water flow, overcoming low or unreliable water pressures.

Thermostatic Electric Showers

Thermostatic electric showers work in the same way as an electric shower, with the added benefit of thermostatic temperature control. They regulate the water temperature to your personal needs, regardless of other water usage in the household.

Shower Accessories

Triton offers a wide range of showering accessories including shower heads, kits, bar brackets as well as hoses and rails. As you would expect all are tested thoroughly to work perfectly with our range of showers and in the UK market. Always fit Triton accessories to safely get the best out of your shower for longer.

Power Showers

Power showers have an integrated pump to boost flow rate. They draw from both hot and cold water supplies which are mixed within the unit, and are only suitable for low pressure systems.

Inclusive Showers

Inclusive showers have been specifically designed to combine everyday good looks with easy to use features, aiding independent living. A selection of products are RNIB, BEAB CARE or TMV3 endorsed for extra safety assurance, be it for care, nursing homes or a stylish at-home adapted bathroom.

Eco Showers

Eco Showers have been designed to offer 50% reduction in water usage when compared to conventional showers and meet the Home Quality Mark. Ideal for new-build or self-build projects.

Choose the solution you require and then look for the relevant colour or symbol to find the right Triton shower for you...



Value for Money



Ease of Installation



Affordable Style



Inclusive Showering

Shower symbols explained

Look for the following symbols on our showers:



Showers which are suitable for both High and Low pressure systems.



Terminal to accommodate both left and right hand cable entry points.



Showers which are suitable for High pressure systems.



Water inlet to accommodate both left and right water entry points.



Showers which are suitable for Low pressure systems.



Mixer showers and taps are guaranteed for 5 years full parts and labour for domestic use.



Showers which are suitable for Low pressure systems when used with a pump.



Electric showers are all guaranteed for 2 years full parts and labour for domestic use, with the option to extend to 5 years.



Showers which are suitable for cold mains systems.



All power showers and pumps are guaranteed for 1 year full parts and labour for domestic use, with the option to extend to 5 years.



Rub clean shower head can be rubbed clean to remove scale build up.



The shower is operated by a discreet control panel which is located away from the power pack. The power pack can be hidden in a loft or airing cupboard.



Suitable for hard water areas, helping to reduce scale build up.



Indicates that a product can be used to achieve water efficiency standards set by this mark.

Accreditations



BEAB CARE - British Electrotechnical Approvals Board Accreditation.



RNIB - Royal National Institute of Blind People Accreditation.



All electric showers comply with BEAB, CE and BSI Kitemark approvals.



TMV2 is an accreditation for thermostatic mixing valves that conform to BS-EN 1111 and BS EN 1287.



TMV3 is a standard created for thermostatic mixing valves that comply with NHS Estates requirements.



WRAS - The Water Regulations Advisory Scheme accreditation.



The Made in Britain marque was created to help consumers, both at home and abroad, identify and choose British made goods.



Thermostatic temperature explained

(Available for mixer, electric, digital and power showers)

You'll notice some of our showers are described as Thermostatic. Thermostatic showers blend incoming water to compensate for variations in the pressure and/or temperature to maintain a selected temperature. This allows you more control over your showering experience, which is ideal for busy households, particularly those with children or elderly users.



Digital Showers

Ideal for injecting a little high-tech into your first thing, digital showers blend first-rate performance with cutting-edge design, allowing you to start the unit remotely for maximum control.

A digital shower should be the first thing on the shopping list for tech savvy shower users. Stylish, contemporary and highly personal. A wide range of mix-and-match accessories is also available to create the look you desire. See pages 18-21.

There's a digital option for every type of home hot water system including those with a combi boiler. Plus you can choose a single or dual outlet which includes a diverter to overhead shower or handset (as seen below).



Digital Mixer Showers

HOST

With a number of top-spec features, HOST has been created by Triton's own designers to maximise your first thing, wherever and whatever it is. Incorporating features such as customisable pre-sets to save your favourite settings and a clear temperature read-out, plus a silent motor so your 5 minute morning escape is not disturbed.

All you have to do is turn on the shower and step in!



Affordable Style

Key features and benefits

Shower comfort

The HOST digital mixer puts you fully in control of your showering experience with the following features.

Presets

Customisable presets store your favourite shower settings. Simply press one of three presets to go straight to your preferred shower.

- 'Just shower' provides regular shower settings
- 'Relax' offers a gentle spray (e.g. for rinsing)
- 'Energise' offers a powerful spray (e.g. post workout).

Alternatively simply fine tune your shower using 16 temperature and 10 flow levels. Customising your shower has never been easier with Triton's HOST.

Easy to read display

The full text, full colour easy to read display confirms the selected preset at start up and shows temperature and flow settings. Perfect for bleary eyes first thing.

Remote start/stop

The optional portable wireless remote start/stop with warm up function means you can turn on the shower while you grab a bit longer in bed. The warm up is completed in minutes and automatically stops should you return to the Land of Nod.

Peace and quiet

The HOST digital mixer is silent running, even the pumped low pressure version that uses new quiet motor technology. So whether you're a sun-up survivor or early morning escapist, you are free to shower any time of the day or night.

Shower choice

Create the perfect shower for your bathroom.

Designer finish

Choose from three colour finishes and combine with your choice of Mix & Match accessories (see pages 18 to 21) or select from the popular All-in-One packs.

For all systems

There is a HOST digital mixer shower for every type of hot water system including combi boilers. We have options for high or low pressure, so that means the HOST range is suitable for combis, mains cylinders and gravity fed cylinders – see page 51.

Refurb or upgrade

Wireless so you are free to position the splash proof shower controller anywhere in the bathroom (within 10 metres of the mixer box). Also, no wires make it easy to upgrade any existing digital mixer shower.

Wireless or Wired

The shower controller is powered by 3x AA lithium batteries (supplied) that are easy to change. Alternatively, route a 10m cable (also supplied) where there is access to wall voids.





Complete the look

To achieve this look you'll need:

- HOST black digital shower controller
Ref: HOSDMM (HP) OR HOSDMMP (LP)
- HOST mixer box (e.g. in roof space or cupboard)
- HOST remote start stop Ref: HOSDMRSS
- Circular thin fixed shower head 300mm
Ref: TSHFCIR300CH
- Circular ceiling arm 200mm Ref: TSARMCIR200V
- 1.5m chrome hose Ref: REHOSE150C
- Circular integrated wall outlet & holder
Ref: TSHHWOCIRCHR
- Circular 1 position shower head - chrome
Ref: TSHUMIACHR



HOST black digital shower controller

Available in the main shower packs below:

Single outlet mixer with controller Ref: HOSDMS

Multi outlet mixer with controller Ref: HOSDMM

Single outlet pumped (LP) mixer with controller
Ref: HOSDMSP

Multi outlet pumped (LP) mixer with controller
Ref: HOSDMMP

tritonshowers.co.uk



HOST cloud grey digital shower controller



HOST white digital shower controller

For more accessories and combination packs
See page 18-21

For further inspiration and other accessory options including taps visit tritonshowers.co.uk/digital or your local bathroom showroom



HOST remote start/stop

Ref: HOSDMRSS



HOST mixer box

Not available to purchase as a single unit



Mixer Showers

Triton mixers offer a wide choice of styles and functions. Each model is expertly designed to provide your ideal 'first thing' shower.

From fashionable bar diverters to versatile concentric mixers, with plenty of styles to choose from and unbeatable quality, the only hard part is deciding which one you like the most.



Eden Bar Diverter

- All chrome finish
- Elegant Eden lever metal handles
- Separate integral diverter and temperature controls with clear handle markings
- Supplied with fast fit push-fit brackets for an easy installation
- Rigid riser rail kit
- 200mm circular fixed drencher head
- Height adjustable, push button slider
- 5 spray pattern rub clean circular shower head
- 1.5m anti-twist, extended length, chrome hose

Ref: UNEDTHBMDIV



Affordable Style

Mixer Showers

The Eden Range

The Eden mixer range offers a choice of exposed or built in valves delivering great showering performance, all housed in a simple and stylish design. Providing the finishing touch to every designer bathroom creation. Offering all the performance without the drama.



Affordable Style



Matching taps available

Providing the finishing touch to the bathroom, select Eden taps to coordinate with your Eden shower. There are a range of options for both basin and bath and all have, of course, been tested for UK bathroom conditions.



Eden TMV2 Bath Shower Mixer with Wall Holder Kit

Ref: UNEDTHBSM

Eden TMV2 Bath Shower Mixer with Riser Rail Kit

Ref: UNEDTHBSMRR



Eden Bath Shower Mixer

Ref: UNEDBSM



Eden Mini Mono Basin Mixer with Click Waste

Ref: UNEDTPBASMM



Eden Bath Filler

Ref: UNEDTPBAF



Eden Mono Basin Mixer with Click Waste

Ref: UNEDTPBASM



Eden Bar Mixer

- All chrome finish
- Elegant Eden lever metal handles
- Separate flow and temperature controls with clear handle markings
- Supplied with fast fit push-fit brackets for an easy installation
- Automatic safety shut down
- New circular kit
- 5 spray pattern rub clean circular shower head
- 1.5m anti-twist, extended length, chrome hose

Ref: UNEDTHBM



Eden Sequential Mixer Shower

- All chrome finish
- Single, elegant Eden lever metal handle to control the temperature with constant flow
- 2 in 1 solution - includes cover plate and wall outlet for concealed option or can be exposed only
- New circular shower rail kit
- 5 spray pattern rub clean circular shower head
- 1.5m anti-twist chrome hose

Ref: UNEDTHSQM



tritonshowers.co.uk



Eden Dual Control Mixer Shower Valves

- All chrome finish
- Elegant Eden lever metal handles
- Slim rectangular cover plate
- Choice of diverter for two outlets or single outlet option
- New mix and match accessories range to complement Triton dual control valves. See page 18 -21 to mix and match

Ref: UNEDTHDCDIV (Two outlet)
UNEDTHDCMX (Single outlet)

Eden Concentric Mixer Shower

- All chrome finish
- Separate flow and temperature control
- 2 in 1 solution – includes cover plate and wall outlet for concealed option or can be exposed only
- New circular shower rail kit
- 5 spray pattern rub clean circular shower head
- 1.5m anti-twist chrome hose

Ref: UNEDTHCM
UNEDTHCMEXT (extended 940mm rail)

Eden Eco Concentric Mixer Shower

An eco model of Triton's successful Eden range, the Eden Eco Concentric Mixer combines sleek design and energy efficiency. Factory fitted with a 'flow regulator' to save water, it's an intelligent mixer shower whose maximum flow rate – 6 l/pm

Ref: ECOEDTHCM



Mixer Showers

The Kensey Range

The Kensey range offers a contemporary twist on a traditional crosshead style as well as great performance to create a satisfying showering experience. Ideal for updating a traditional bathroom while being easy for all to use. The only thing missing from the range is the designer price.



Affordable Style



Kensey Built-in and Exposed Concentric

- All chrome finish
- Contemporary Kensey cross handle
- Separate flow and temperature controls
- 2 in 1 solution – includes cover plate and wall outlet for concealed option or can be exposed only
- New slender kit
- 5 spray pattern rub clean circular shower head
- Optional clip-on tray
- 1.5m anti-twist chrome hose

Ref: UNKETHCM



Matching taps available

Continue with unique crosshead design by co-ordinating with some Kensey taps for your basin and bath.



Kensey Mono Basin Mixer with Click Waste

Ref: UNKETPBAM



Kensey Bath Filler

Ref: UNKETPBF



Kensey Bath Shower Mixer with Shower Head

Ref: UNKEBSM



Kensey Basin Tap Pair with Click Waste

Ref: UNKETPBAS

Kensey Bar Mixer

- All chrome finish
- Contemporary Kensey cross handles
- Separate flow and temperature controls
- Supplied with fast fit push-fit brackets for an easy installation
- New slender kit
- 5 spray pattern rub clean circular shower head
- Optional clip-on tray
- 1.5m anti-twist chrome hose

Ref: UNKETHBM

MIX & MATCH



Kensey Dual Control

- All chrome finish
- All metal contemporary Kensey handles
- Slim design oval cover plate
- Choice of diverter for two outlets or single outlet option
- New mix and match accessories range to complement - see pages 18 - 21

Ref: UNKETHCDIV (Two outlet)
UNKETHDCMX (Single outlet)

Kensey Built-in and Exposed Sequential

- All chrome finish
- Single, forward facing, contemporary Kensey metal cross handle to control the temperature with constant flow
- 2 in 1 solution – includes cover plate and wall outlet for concealed option or can be exposed only
- New slender kit
- 5 spray pattern rub clean shower head
- Optional clip-on tray
- 1.5m anti-twist chrome hose

Ref: UNKETHSQM



To add a personal touch, take a look at our accessories.

See page 18 - 21



Shower Accessories

Mix and Match



Affordable Style

MIX & MATCH

Now you can create your perfect personal shower design with our flexible Mix and Match options. Simply combine our easy to use valves with your own choice of shower heads – fixed, handheld or both, wall holders, arms and risers rails to make Affordable Style ideal for you and your home.

Step 1

Pick a mixer shower style:



**Kensey – Dual Control
Thermostatic Mixer Showers**

Ref: UNKETHDCDIV (Two Outlet)
UNKETHDCMX (Single Outlet)



**HOST Black Digital
Shower** (See page 10-11)



**Eden – Dual Control
Thermostatic Mixer Showers**

Ref: UNEDTHDCDIV (Two Outlet)
UNEDTHDCMX (Single Outlet)

Step 2

Pick a fixed shower head:



Circular 200mm

Ref: TSHFISABCH



Circular Thin

Ref: TSHFCIR200CH (200mm)
TSHFCIR250CH (250mm)
TSHFCIR300CH (300mm)



Square 200mm

Ref: TSHFKELSCH



Square Edge Thin

Ref: TSHFSQ200CH (200mm)
TSHFSQ250CH (250mm)
TSHFSQ300CH (300mm)



Traditional 200mm Rose

Ref: TSHFTRAD200CH

Simply follow the steps to configure your perfect shower with a variety of styles to suit your bathroom.

Step 3

Pick a ceiling or wall arm:



200mm Circular Ceiling Arm
Ref: TSARMCIR200V



400mm Circular Wall Arm
Ref: TSARMCIR400H



200mm Square Edge Ceiling Arm
Ref: TSARMSQ200V



400mm Square Edge Wall Arm
Ref: TSARMSQ400H

Step 4

Choose a handheld shower head:



1 Position Circular Microphone
Ref: TSHMAMBICH



1 Position Circular
Ref: TSHUMIACHR



5 Position Circular
Ref: TSHM8RCCHR



1 Position Square Edge Microphone
Ref: TSHMELLICH



1 Position Square Edge
Ref: TSHMKATICH

Step 5

Choose a riser rail or wall holder:



Slender
Ref: TSKKIANCH



Circular
Ref: TSKADAM2CH



Square Edge
Ref: TSKCALLCH



Circular Wall Holder
Ref: TSHHCIRCHR



Square Edge Wall Holder
Ref: TSHHSQCHR



Circular Integrated
Ref: TSHHWOCIRCHR



Square Edge Integrated
Ref: TSHHWOSQCHR

Choose a hose outlet if integrated option (above) is not selected:



Circular Hose Outlet
Ref: TSWOCIRCHR



Square Edge Hose Outlet
Ref: TSWOSQCHR

Finally, add a hose.



1.25m Ref: TSHG1203
1.5m Ref: REHOSE150C
1.75m Ref: TSHER103
2m Ref: TSHG1266

Unique best seller



Ceiling Fed Riser Kit
includes hose and showerhead
Ref: TSKFCRR CIR



1 Position Classic
Ref: TSHMTRAD1CH

Accessory Packs



Affordable Style

Our most popular combinations. To help you select the accessories you'll need with your chosen mixer shower, here are four of our most popular Mix and Match combinations. Each one includes all you'll need to complete your shower – so you can be sure that nothing is forgotten!

Remember, when you choose Triton Affordable Style showering accessories they are all designed and tested to work perfectly with your shower.

Combination Pack 1

Ref: TSPKDIVHHCIR

1. 200mm circular fixed head
2. 400mm circular wall arm
3. Circular wall shower head holder
4. Circular concealed wall outlet
5. 1.5m hose
6. Circular 1 position shower head



Combination Pack 2

Ref: TSPKDIVRRCIR

1. 200mm circular fixed head
2. 400mm circular wall arm
3. Circular concealed wall outlet
4. Slender riser rail kit
5. 1.5m hose
6. Circular 1 position shower head

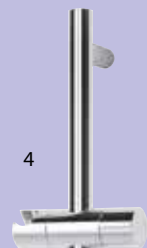

Choose from our Eden, Kensey Dual Control or HOST digital mixer showers on pages 8-17.

Combination Pack 3

Ref: TSPKDIVHHSQ

1. Square edge 200mm fixed head
2. 400mm square edge wall arm
3. Square edge wall shower head holder
4. Square edge concealed wall outlet
5. 1.5m hose
6. Square edge 1 position shower head



tritonshowers.co.uk

Combination Pack 4

Ref: TSPKDIVRRSQ

1. Square edge 200mm fixed head
2. 400mm square edge wall arm
3. Square edge riser rail kit
4. Square edge concealed wall outlet
5. 1.5m hose
6. Square edge 1 position shower head



Mixer Showers

The Dene Range

Looking for style, versatility and an easy installation?
Our Dene range should be the very first thing on your list. Coming in a handsome, minimal, chrome design and suiting every kind of household water system, it really is the perfect all-rounder. If you wish to fit the shower yourself, then no problem, or if you're hiring a professional they'll thank you for the easy task. The only trouble will be choosing the right valve for you – the Dene comes with a choice of seven!



Ease of Installation

Dene Bar Mixer – Standard Specification:

- All chrome with quality metal handles
- Suitable for all hot water systems including gravity fed
- Durable design including ceramic disc flow control
- Riser rail kit with adjustable top bracket
- 3 spray pattern rub clean shower head
- Fast fit surface brackets
- Easy-fit pipe spacing guide
- Push fit pipe connectors
- Connects to plastic or copper pipes

Dene Hi-Flo Bar Mixer for performance

As the standard specification but also featuring:

- Generous Flow Rates
- 5 l/min at 0.1 bar



Ref: UNDETHBM

Dene Cool to Touch Bar Mixer for families

As the standard specification but also featuring:

- Cool to touch valve

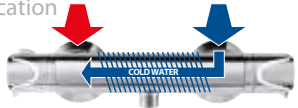

The cold supply runs across the valve before being mixed.

Ref: UNDETHBMCT

Dene Eco Bar Mixer for water saving

As the standard mixer but also featuring:

- 6 l/min water efficiency rating
- Factory fitted flow limiter
- Assists compliance with Building Regulations and the Home Quality Mark (HQM)

Ref: ECODETHBM



Matching taps available

It's also easy to complete the Dene look with some simple but stylish tap options



Dene Mono Basin Mixer with Click Waste

Ref: UNDETPBAM



Dene Basin Tap Pair with Click Waste

Ref: UNDETPBAS



Dene Bath Filler

Ref: UNDETPBF



Dene Bath Shower Mixer with Shower Head

Ref: UNDEBSM



Dene Concentric Mixer

- Accessible forward facing controls
- Suitable for all hot water systems including gravity fed
- 3 spray pattern rub clean shower head

Ref: UNDETHEXCM



Dene Sequential Mixer

- Single control for temperature adjustment with constant flow
- Suitable for all hot water systems including gravity fed
- 3 spray pattern rub clean shower head

Ref: UNDETHEXSQM



Dene Bar Mixer with Diverter

This is to the standard bar mixer specification, plus the following:

- Diverts between pivot shower head and handset
- Handset is height adjustable for families
- Large diameter pivot shower head

Ref: UNDETHBMDIV



Mixer Showers

EXE – Quality at a great price

Want quality, durability and value for money? Look no further than the Triton EXE range, offering a choice of bar mixers and bath shower mixers with two handle options. Featuring standard inlet centres, all are ideal for a quick product replacement. All EXE products will work with all hot water systems, including gravity fed. Co-ordinating taps are also available.



EXE Bar Mixer (left)

- Suitable for all hot water systems including gravity fed
- Appealing design and great value for money
- Durable design including ceramic disc flow control
- One piece, one screw rail fixings with adjustable centres
- Thermostatic control

Ref: UNEXTHBM



EXE Lever Bar Mixer (right)

- As standard but with the benefit of our easy to use lever handles
- Suitable for all applications and user abilities. The sleek paddle makes EXE the ideal combination of style and functionality

Ref: UNEXTHBMINC



Matching taps available

For a quick and easy replacement the EXE taps for either your bath or basin come as you would expect, with a choice of standard or lever handle. All come with manual temperature control.



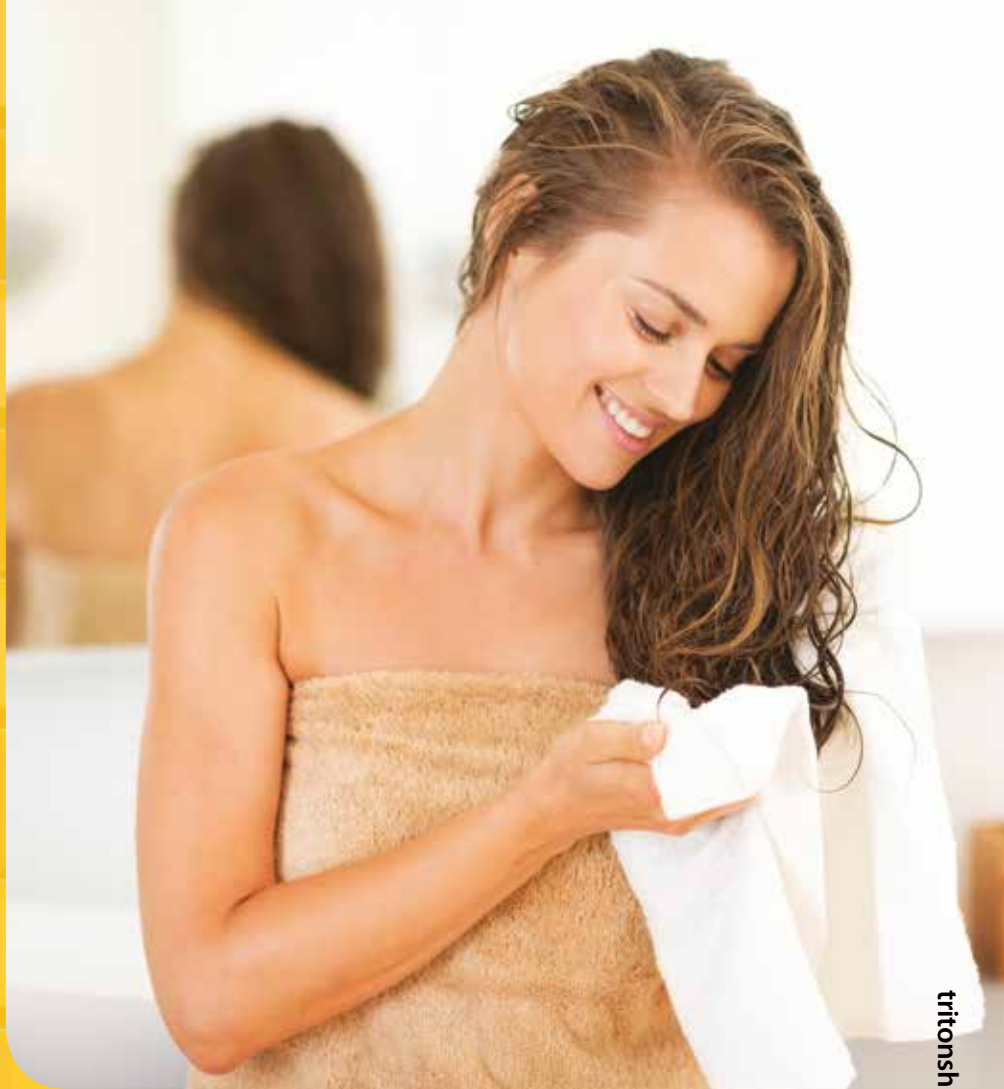

tritonshowers.co.uk

Electric Showers

Triton are famous for electric showers, and with good reason. Advanced shower technology and outstanding designs are combined to maximum effect in our extensive range.

From the stylish Amore electric shower, to the easy to install T80 family, there's a model to match any bathroom or budget. Whichever you choose, all of our electric showers benefit from the Triton commitment to innovation and affordable style.

Electric Showers

Amore

Sleek, modern and ultra-stylish, with clever fingertip touch controls and precise digital temperature readings to create and set your ideal showering experience. Amore is an elegant and easy-to-operate shower range you're sure to love using first thing. And with a choice of three smart finishes, Amore showers are irresistibly good looking too.



Affordable Style

Gloss Black



Amore Electric Shower

- Choice of three finishes
- Available in 8.5kW and 9.5kW
- Digital display with temperature readout
- Contemporary sleek cover
- Accompanied by the slender kit, circular rub clean 5 mode shower head and clip-on bottle tray

Ref: ASPAMO8GSBLK – 8.5kW
ASPAMO9GSBLK – 9.5kW
ASPAMO8GSWHT – 8.5kW
ASPAMO9GSWHT – 9.5kW
ASPAMO8BRSTL – 8.5kW
ASPAMO9BRSTL – 9.5kW



Gloss White

Brushed Steel



Touch

The intuitive Triton Touch brings modern style and state-of-the-art technology into your bathroom. With its easy-to-use, digital touch screen controls, you can set your ideal temperature and flow every time. Boasting a high-gloss finish, adjustable riser rail fixings and an easy-clean flat screen, it's easy to fit and great to look at.



Touch

- Touch controlled start/stop button
- Clear illuminated display indicates:
 - Shower is on
 - Water temperature
 - Low water pressure
- Phased shutdown – when the shower is switched off, it flushes out preheated water before stopping completely to help prevent limescale
- Rub clean shower head
- 5 spray patterns

Ref: ASPTOU8WHT – 8.5kW
ASPTOU9WHT – 9.5kW



Wireless Electric Showers

Aspirante Wireless/T300SI

Want the modern look of a digital shower but with cold water connectivity only? Then choose from Triton's unique range of wireless or remote electric showers. Only available from the UK's market leader!



Aspirante Wireless Electric Shower

We've applied our wireless mixer technology to this stunning electric shower. The power pack and plumbing are hidden in a loft or cupboard, leaving only the sleek riser rail, handset and the elliptical elegance of the polished chrome control panel on show. Suitable for cupboard or loft installations.

Ref: ASP3CHR09SIWL – 9.5kW
ASP3CHR10SIWL – 10.5kW



**What's your
first thing?**



T300si Wireless Electric Shower

This electric, wireless model benefits from the same clever showering technology as the Aspirante Wireless, but features a beautiful satin/chrome ecliptic control panel.

Design freedom – position the wireless remote control anywhere within 10 metres of the power unit.

- Suitable for cupboard or loft installations
- Pick the traditionally installed wall kit or the option of the through the ceiling rail (shown).
- Easy to use and easy to clean
- Push button start/stop to select your favourite shower setting every time
- Phased shutdown – when the shower is turned off, the water continues to run for a few seconds to flush out any water before stopping completely to help prevent limescale build up
- ‘Low pressure’ indicator – operates when the water pressure is insufficient
- Rub clean shower head with 5 spray patterns

Ref: SP3009SIWLSA - 9.5kW
SP3010SIWLSA - 10.5kW



T80 Family

Triton's T80 family of electric showers has been an iconic household favourite for more than 30 years and includes Britain's most popular shower; the T80z Fast Fit. Packed with design features that will appeal to both the homeowner and the professional installer, T80 showers feature the latest Swing-Fit™ and Swivel-Fit™ installation technology as well as delivering Triton style, quality and showering performance. A T80 shower makes it easy to create your perfect shower first time - both you and your installer will love it.



Ease of Installation



See page 51 for more information on ease of installation.

T80 Pro-Fit Electric Shower

A brilliantly finished model which can be easily fitted from left or right, the highly durable Triton Pro-Fit is suitable for copper or plastic fittings, as a compression or push fit. Boasting Dura-Flow™ technology for a longer lasting shower, plus fully adjustable riser rail and extended anti-twist hose for added flexibility, it's an electric shower as easy to use as it is to connect.

- 8 water and 8 cable entry points
- Makes it easy to replace any existing models
- Easy to use controls for both flow and temperature
- 5 mode Dura-Flow™ shower head that is easy to clean

T80 Pro-Fit Eco

The eco model is all about being green. Cutting water usage down by up to 50%, it's great for the environment, and your wallet, too!

Ref: SP8007PF - 7.5kW
SP8008PF - 8.5kW
SP8009PF - 9.5kW
SP8001PF - 10.5kW
ECO8008PF - Eco 8.5kW



What you should expect from a T80

An easy-to-install, stylishly designed electric shower, it's no wonder the T80 is one of our most popular units. Featuring up to eight water entry points and a sleek, simple look, the T80 is particularly popular as a replacement unit, coming highly endorsed by users and tradesmen alike.



The Nation's Favourite



T80Z Thermostatic Fast-Fit

The T80Z Thermostatic Fast-Fit also uses the Dura-Flow™ technology for a longer lasting shower, making it ideal for hard water areas.

With all the installation benefits of the Fast-Fit (see page 32) but with precise thermostatic temperature control, this T80 is ideal for busy households where someone is always using water, whether flushing the toilet or running a tap. Whatever is happening, the T80Z Thermostatic Fast-Fit will maintain your desired showering temperature.

- 8 water and 6 cable entry points
- Makes it easy to replace any existing models
- Easy to use controls for both flow and temperature
- 5 mode Dura-Flow™ shower head that is easy to clean

Ref: SP8008ZFFTHM - 8.5kW
SP8009ZFFTHM - 9.5kW
SP8001ZFFTHM - 10.5kW

tritonshowers.co.uk



Electric Showers

T80Z Fast-Fit

The UK's most popular electric shower, the Fast-Fit offers loads of installation benefits along with excellent value for money. Available in white/chrome or chrome.



The Nation's Favourite



T80Z Fast-Fit Electric shower

Our original T80 model, the Fast-Fit has that unbeatable combination of an easy-to-install shower, classic looks and all at great value for money. Loved by families and installers alike the T80Z Fast-Fit has:

- 8 water and 6 cable entry points
- Makes it easy to replace any existing models
- Easy-to-use controls for both flow and temperature
- 5 mode Dura-Flow™ shower head that is easy to clean

Ref: SP8007ZFF - 7.5kW white
SP8008ZFF - 8.5kW white
SP8009ZFF - 9.5kW white
SP8001ZFF - 10.5kW white
ECO8008ZFF - 8.5kW eco
SP8CHR8ZFF - 8.5kW chrome
SP8CHR9ZFF - 9.5kW chrome
SP8CHR1ZFF - 10.5kW chrome



MADE IN
BRITAIN



Pumped Electric Showers

T90XR/T80SI

Looking for a low pressure showering solution? Look no further. Triton has a range of pumped electric showers which have a built-in pump, boosting water flow to overcome low or unreliable water pressures.

T90XR Pumped Electric Shower

With an integrated pump, this simple, stylish unit is designed for homes where water pressure is low, unreliable or non-existent. The unit features the latest technology to make it significantly quieter and slimmer than its predecessors. It is also an ideal replacement for older T90 variants, with compatible water and cable connections for quick and easy installations.

Ref: SP9008SI – 8.5kW
SP9009SI – 9.5kW



tritonshowers.co.uk

T80SI Pumped Electric Shower

- Pumped electric for low or negligible water pressures
- Push button start/stop
- Separate temperature and power controls
- Power on indicator
- Integrated pump
- Rub clean shower head – 5 spray patterns

Ref: SP8P08SI – 8.5kW
SP8P09SI – 9.5kW





Power Showers

Triton Power Showers mean everyone can have an invigorating shower experience whenever they want. Designed for low pressure plumbing systems, these stylish showers combine a mixer and an integral pump in one.

All Triton Power Showers have been designed not only to boost performance but to enhance and complement any style of bathroom. Designed with clean, simple lines the AS2000XT and AS2000X are discreet in white, while the Aspirante model is available in a statement making chrome finish. Whichever you choose, you can be sure their power is a force to be reckoned with.



Aspirante Power Shower

Under a beautifully polished chrome fascia, this power shower has an integrated pump that provides a luxurious high flow rate of 14 l/pm. Matched with an all chrome riser rail and handset, this model offers optimum style and performance for any bathroom.

Thermostatic Control – constantly regulated temperature gives the user more precise control and safer showering.

Automatic Shutdown – should either the hot or cold water supplies fail.

Adjustable Maximum Temperature Stop – reduces the risk of accidentally turning the temperature too high.

Rub Clean Shower Head – 5 spray patterns.

Ref: ASP2000THM



AS2000X Power Showers

Suited only for low pressure systems, these power showers also provide an outstanding flow rate of up to 14 l/pm, but with a choice of manual or thermostatic temperature control.

Adjustable Maximum Temperature Stop – reduces the risk of accidentally turning the temperature too high.

Push Button Start/Stop – to select your favourite shower setting every time.

Rub Clean Shower Head – 5 spray patterns.

Ref: TAS2000XMAN
TAS2000XTHM (thermostatic)

(Thermostatic model shown)





Inclusive Showers

Design. Safety. Simplicity. For extra care.



Safeguard+

Style doesn't need to be sacrificed for function. Inclusive showering should mean you can have the stylish products you desire in your home and that everyone finds them easy to use day after day.

As the manufacturer of the UK's favourite shower, it is only natural that we would want everyone to be able to enjoy showering. That's why in 2000, we were the first to produce an electric shower specifically designed for the care market. Through in depth discussions with carers and organisations such as the RNIB and BEAB, Triton has continued to develop a variety of innovative

solutions for independent living. Design features such as audible feedback and easy to use operating controls are just some of the benefits which Triton's extensive range has to offer.

All products in this carefully selected range have thermostatic temperature control as well as easy to use, intuitive controls.

Inclusive Showering products also comply to one or more of the following national safety accreditations.



Care Showers

Elina

Elina mixer showers offer key features to help users lead more independent lives, without compromising on styling.

The Triton 'Inclusive Showering' Range is TMV3 accredited and ideal for bathroom adaptations, commercial healthcare applications and nursing homes.



Elina TMV3 Concentric Mixer – Built-in

With its striking cylindrical face, the built-in Elina delivers the style and functionality that you would expect from all Triton showers.

Ref: ELICMINCBT (Valve and grab kit)
ELICMINCBTVO (Valve only)

Elina TMV3 Concentric Mixer – Exposed

This exposed mixer is available with separate flow and temperature controls for ease of use.

- Separate flow temperature controls
- Accessible front facing level controls that are easy to turn
- Automatic shutdown if hot and cold supplies fail
- Simple to install and maintain
- Factory set maximum temperature at 38°C
- Ideal for use in care homes, hospitals and nursing homes

Ref: ELICMINCEX (Valve and grab kit)
ELICMINCEXVO (Valve only)



Elina TMV3 Inclusive Bar Mixer Shower

Stylish, sleek and robust. The Elina TMV3 Bar Mixer has tamper-proof, separate controls for flow and temperature.

- Separate flow and temperature controls
- Tamper-proof lever controls
- Automatic shutdown if hot and cold supplies fail
- Simple to install and maintain
- Factory set maximum temperature at 38°C

Ref: ELITHBMINC3 (Valve and grab kit)
ELITHBMINC3BOT (Valve only)



tritonshowers.co.uk



Elina TMV3 Sequential Mixer Shower

Exposed Simple and easy to use, with its single control, the Elina sequential mixer also has TMV3 thermostatic performance for extra safety assurance giving you peace of mind for all the family.

Ref: ELITMV3EXSL (Valve only)

Built-in Designed to fit flush to your wall giving a chic look to your bathroom, the Elina Built-in features the same operating and thermostatic features as the Elina Exposed. Choose from our selection of riser rail kits and shower heads to suit your needs.

Ref: ELITMV3BTSL (Valve only)

- TMV3 Thermostatic Control – constantly regulated temperature gives the user more precise control and safer showering
- Automatic Shutdown – should either hot or cold water supplies fail
- Single control – for temperature adjustment with constant flow
- Tamper proof lever control
- Factory set maximum temperature at 38°C
- Ideal use for care homes, hospitals and nursing homes
- Shower kit, riser rail and shower head each sold separately
- See our accessory range on page 44 - 45

Care Showers

Omnicare

The new Omnicare has all the Safeguard+ and T150+ safety features you should expect from a Triton 'Inclusive Shower', but as styling has evolved so has Omnicare. With its new sleek form, the option of two designs and minimalist simplistic look, this shower ticks all of the inclusive showering boxes. The user has all the benefits of a BEAB Care approved shower without having to compromise the styling of their bathroom.

**BEAB
CARE**

INC: Inclusive showering



Omnicare Style with Grab Kit

Ref: CINCSTY08WGRB - 8.5kW
CINCSTY09WGRB - 9.5kW



Omnicare Style with Extended Kit

Ref: CINCSTY08W - 8.5kW
CINCSTY09W - 9.5kW

**BEAB
CARE**





Omicare Design with Grab Kit

Ref: CINCDES08WGRB - 8.5 kW
CINCDES09WGRB - 9.5 kW



Omicare Design with Extended Kit

Ref: CINCDES08W - 8.5kW
CINCDES09W - 9.5kW

Design:

- Stylish form with a variety of finish choices – an option to suit all bathrooms
- Tactile temperature dial with soft grey tones offers helpful visual contrast
- A choice of kit depending on your needs; extended kit for more flexibility while showering, or the grab kit for the optimum safety and support
- The Omnicare connects to both analogue and digital waste pumps
- With multiple pipe and cable entry points, a generous footprint and a kit for plugging any existing holes in your wall, the Omnicare is designed with ease of replacement in mind

Safety:

- Constantly regulating water temperature within +/- 1°C, the Omnicare gives the maximum temperature reassurance with the BEAB Care mark
- The Design unit has RNIB approval
- Safe-set™ allows the maximum temperature to be set whilst allowing full rotation of temperature dial
- Choice to set the duration of the shower ranging from 5 minutes to 30 minutes, for extra peace of mind whilst showering
- Dual purpose grab rail option is designed to withstand up to 150kg support load, providing a stylish grab rail option if and when it is needed
- Power on illumination along with audible feedback allows ease of use for all users

Simplicity:

- The soft press start/stop requires very little effort when wanting to start or stop your showering experience
- Looped lever handle in the centre of the unit for intuitive use, with its low resistance operation the perfect showering settings can be achieved easily
- With a 2m hose and a lower level handset holder offered with the grab rail, this gives you the flexibility of a seated or standing shower



supporting blind and partially sighted people

To find out more about our inclusive accessories including our unique grab kit

See page 44 - 45

Care Showers

Safeguard+/T150+

Just because you may need a little extra help when showering, doesn't mean you are happy to compromise on the look of your bathroom. Safeguard+ and the T150+ allow you to have both. As part of Triton's commitment to Inclusive Showering, both models have features which have been designed to be used and admired by all.



Safeguard+

Ref: CSGP08W – 8.5kW – White/Chrome
CSGP09W – 9.5kW – White/Chrome

“The Safeguard+ is a well researched and designed product that will meet the needs of a wide variety of clients and is a must for any person or organisation wanting to future proof their home or properties”

Gordon Heath
Occupational Therapist



supporting blind and partially sighted people





T150+

Provides the ideal solution to the challenge of finding a shower that is stylish for the bathroom and that can be easily used by everyone. Inclusive showering of the highest quality is what the T150+ achieves with its attention to design, safety and simplicity.

- BEAB CARE mark - keeps water temperature within +/-1°C for total peace of mind
- Controls - low resistance operation and soft press start/stop button
- Safe-Set™ - ensures tamper-proof maximum temperature setting whilst allowing full rotation of the temperature dial
- Connection - connects to both manual or digital level access waste pump
- Great accessories – comes with longer length 670mm riser rail kit with adjustable fixing centres and 1.75m anti twist shower hose

Ref: SP1508WP – 8.5kW – white/chrome
 SP1509WP – 9.5kW – white/chrome



Care Shower Accessories

Riser Rails, Kits and Hoses

All designed and tested to be used comfortably whether standing or sitting whilst showering. Available in chrome or white to complement your choice of shower.



Triton's standard care kits include:

- 940mm stainless steel polished riser rail
- An easy to use and easy to clean shower head with adjustable settings
- 2m hose ideal for both users and carers

Inclusive Care Riser Kit – white

Ref: TSKCARESTDWHT

Inclusive Care Riser Kit – chrome

Ref: TSKCARESTDCHR



1.75m Chrome Hose –

Ref: TSHER103

2m Chrome Hose –

Ref: TSHG1266





Triton's NEW Grab Riser Rail Care Kits include:

- 940mm polish stainless steel grab riser rail able to withstand up to 150kg support load to provide extra reassurance while showering
- An easy to use and easy to clean 5 position shower head
- 2m hose ideal for both users and carers

A separate shower head holder is also available giving extra flexibility whether standing or sitting (see below).

Inclusive Extended Grab Riser Rail Kit – white/grey (left)

Ref: TSKCAREGRBWHT

Inclusive Extended Grab Riser Rail Kit – chrome/grey (right)

Ref: TSKCAREGRBCHR

TRITON SAFETY RECOMMENDED



Hard Wired Remote

Ref: CGSPRSS

- 10m wire included
- Illuminated Off/On soft press button

Professional advice

For advice on funding a bathroom adaptation for a customer or yourself, Triton recommends checking online at www.hmrc.gov.uk for confirmation of what can be VAT Zero rated. Also, always gain professional advice from your doctor or occupational therapist to discover what extra help could be available.

Testing service

Triton offers an optional testing service in line with the BEAB CARE standard for relevant electric showers and NHS D 08 specifications for TMV3 mixer showers. This ensures ongoing temperature performance is upheld and is ideal for organisations.

Contact Triton on **0844 980 0750** for more details.



Lower Shower Head Holder

Ref: CSGPHHCHR - Chrome (shown)

CSGSPHHWHT - White



Shower Accessories

Beautiful showers deserve beautiful surroundings. That's why Triton have designed a range of accessories with the same attention to detail, quality and style as our showers. Ideal for most shower installations, Triton have a great range of accessories to choose from. Shower heads for electric, mixer and power showers offer a choice of spray patterns to suit your mood and our riser rails include an adjustable bracket which allows you to alter the height and angle of the shower head.

Why Triton Accessories?

Did you know that Triton tests all its shower accessories to ensure they deliver the optimum performance from our showers?

We also consider them to be safety recommended items, ensuring hassle-free showering day after day. So if you're looking to refresh your shower, look no further than our selection of Triton accessories.

**TRITON SAFETY
RECOMMENDED**



tritonshowers.co.uk

To view our full range, visit tritonshowers.co.uk/accessories

Always make sure you choose the correct accessory suitable for your chosen shower.

Get it right first time

Help me choose

So now you have browsed through the Triton showers available, you will need to check which showers work with your home's water system. This section will guide you through the process to make the right selection for you .

What shower can I have?

One of the first questions you need to ask when you're choosing a new shower is "Do I have a High or a Low pressure hot water system?". This is because it will determine the type of shower unit that is suitable and will give you the best performance.

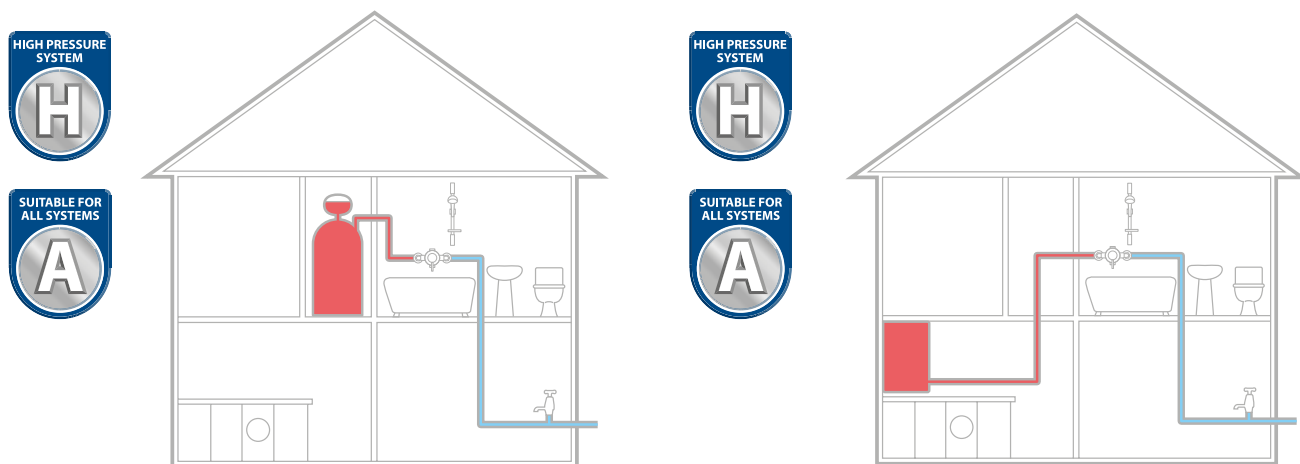

High Pressure Water Systems

Mains Unvented Cylinder

If you have a hot water tank (cylinder), usually found in your airing cupboard, but you don't have a cold water tank (cistern) in your loft, this is an unvented high pressure system. This can look similar to a low pressure system so check carefully to avoid confusion. Also take caution in refurbished houses with disused water tanks.

Mains Combi

If you have a combination (combi) boiler which heats water on demand so there is no hot water storage cylinder or cold water tank, you have a high pressure system.

If you have either of these two set-ups, simply choose from our extensive range of High Pressure showers indicated by the relevant symbol illustrated above (H or A).

Mixer



Electric



Digital

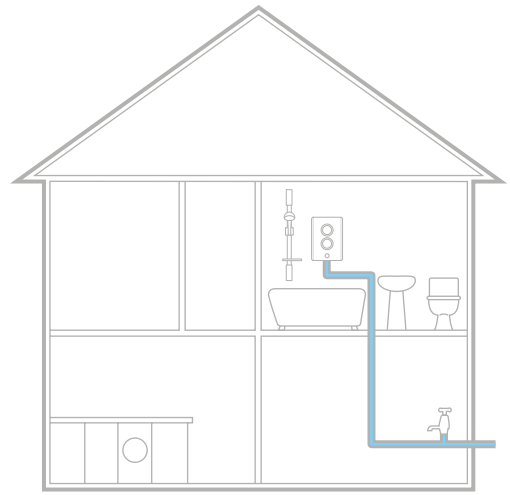
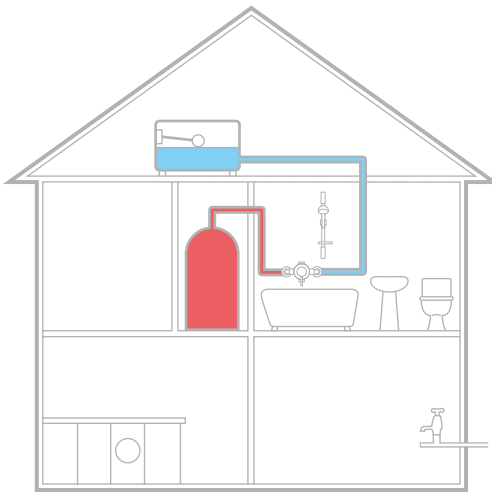

tritonshowers.co.uk

Low Pressure Water Systems

Gravity Fed

If you have a cold water tank (cistern) in your loft and a hot water tank (cylinder) in your airing cupboard, this is a gravity-fed system. It's the most common household plumbing system and means you have a low pressure water system. Having low pressure need not limit your choice of shower type. Simply choose from our extensive range of low pressure suitable showers indicated by the symbol above.

Cold Mains

Most Electric showers can be connected to a cold water mains supply. Simply choose from our extensive range of Electric showers indicated by the relevant symbol illustrated above. If your cold mains does not have the required regulated minimum water pressure, select the T90XR pumped, T150Z pumped electric showers (see page 33).



Low pressure water systems when used with a pump

As low pressure water systems above, but only suitable if used with a pump as indicated by the relevant symbol illustrated above (P).

Electric showers are all guaranteed for 2 years for domestic use, with the option to extend to 5 years.



Fitting Advice

Triton. The UK's Shower Company.
First for getting the job done right first time.

Since the beginning we've always understood the importance of easy installation. When we design a shower we always do it with quick, hassle-free fitting in mind.

We also know installers demand reliability and that's why all our showers can be fitted and forgotten.

On the following pages, technical details for each of our showers can be found, including details of function, styling and entry point details; perfect for easy fitting and easy selection.

Make Triton Showers the first thing on your list.

Take a look at the T80 Pro-Fit

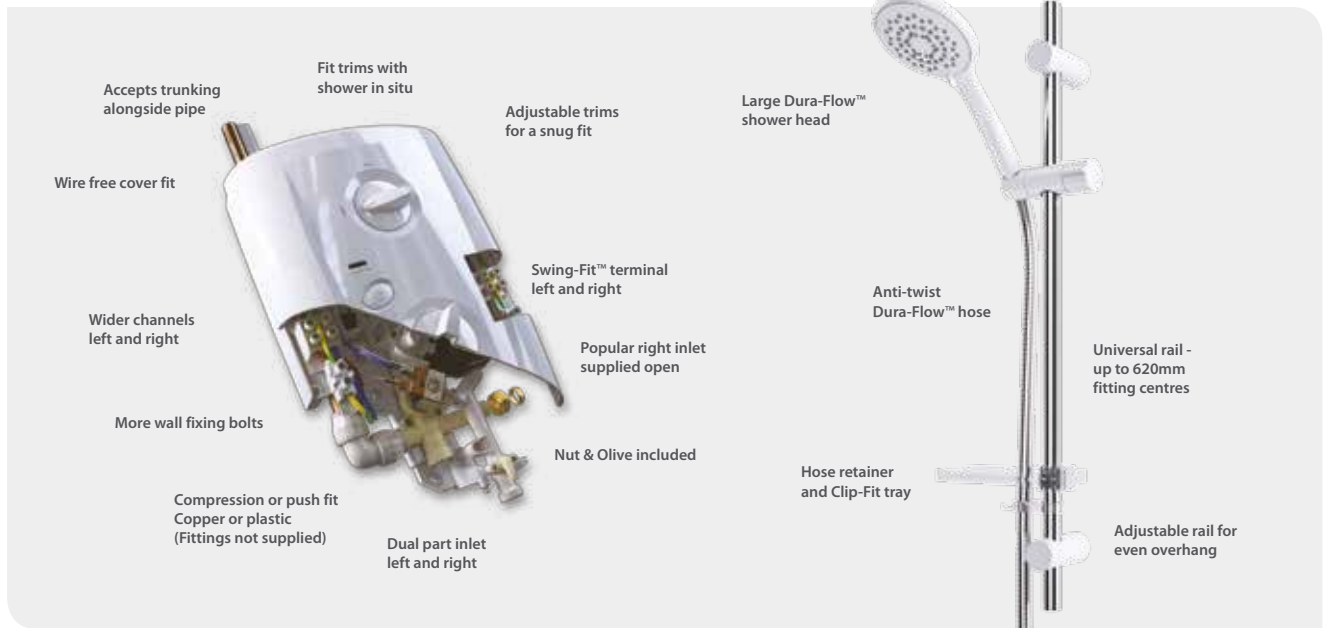

tritonshowers.co.uk

Want to fit a digital shower?

Triton's new HOST makes this easy whatever the plumbing system. See page 9 - 11 for more details. Also see the video on our website.



Mains Combi



Gravity Fed



Mains Unvented Cylinder

For more details, view the video on our website at tritonshowers.co.uk/digital

Installer Section Training



FREE expert training

Sharpen up your skills with Triton and get the job right first time. We offer Electric, Mixer and Power shower training throughout the year. Our hands-on training is FREE and also enables you to network with like-minded people.

Register for FREE now at

tritonshowers.co.uk/training



Swing Fit™

Triton's revolutionary and patented Swing-Fit™ terminal block allows left and right hand cable connection. Simply move the terminal block to the side of the unit you require, screw into place and connect. It really is as easy as that!



Swivel-Fit™

Triton's 180 degree fully reversible Swivel-Fit™ water inlet allows left and right hand pipe connection. Simply swivel into place, screw to secure and connect your pipework, making it ideal for replacing existing showers.



Dual Water Inlet Port

Triton's dual water inlet port allows left and right hand pipe connection. Simply blank off the inlet that is not required using the blanking plug supplied, making it ideal for replacing existing showers.

Installer Section

Euro Standards

Water Efficiency Label - Applicable for Mixer Showers

Triton Showers is proud to be a registered member of the Bathroom Manufacturers Association. The BMA 'Water Efficiency Label' provides a recognisable, consistent measure of water usage for domestic water appliances; designed to help consumers and Installers choose a product.

For more information visit www.europeanwaterlabel.eu



EU Energy Efficiency Label - Applicable for Electric Showers

Bathroom manufacturers across the globe are aiding governments in their quest to reduce water consumption by producing innovative and technologically advanced bathroom products that deliver a bathing experience customers can enjoy while saving water and energy.

The scheme provides easy access to a database of bathroom products which when installed and used correctly will use less water, save energy and save money.

For more information visit www.europeanwaterlabel.eu

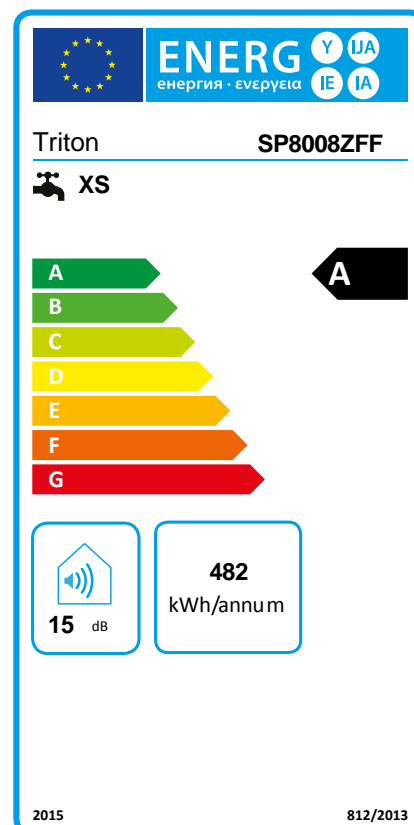

Installer Favourites



T75 Electric Shower

- Dual water inlet port to accommodate left and right hand water entry
- Large temperature control
- Push button start/stop
- Power on indicator
- Rub clean shower head – single spray pattern

Ref: SP7508SC – 8.5kW
SP7509SC – 9.5kW

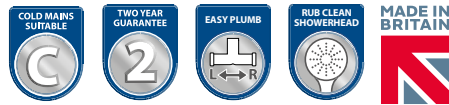

T30i Handwash

- Heats water for hand washing where only cold mains supply is available
- Single control for start/stop and temperature selection
- 200mm swivel arm
- Ideal for use when there is no hot water supply

Ref: T3A3034I – 3kW
T3A7074I – 7kW



T70Z Electric Shower

- Swivel-Fit™ – 180° reversible water inlet providing left and right hand-side water connectivity.
- Single control for start/stop selection and power selection
- Separate temperature and power controls
- Rub clean shower head – 3 spray patterns

Ref: SP7007Z – 7.5kW
SP7008Z – 8.5kW



Need a pump, visit tritonshowers.co.uk
For technical product details

see pages 60-61



Bar Mixer Shower Fixing Bracket

An easy fit option that eliminates the need to measure distance between the inlet centres and accommodates a building-in depth as little as 30mm from the plasterboard face. It also comes with push fit fittings, flow limiters and filters to simplify future maintenance. Suitable for most types of bar mixer and wall mounted bath/shower mixers with 3/4" BSP fittings including the extensive Triton range.

Ref: UNBMXBKT

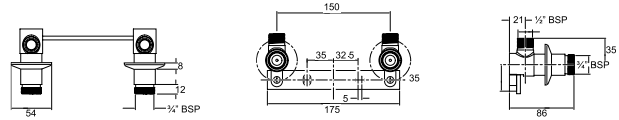

Dimensions given are approximate.

1. Fit the elbows to the bracket using the screws provided.
2. Secure a fixing baton to the depth required in the stud wall and fix the bracket using the screws provided.
3. Complete the pipework to the elbows and make good the walls.
4. Once the tiling is complete you simply fit the trims and push-fit the seals into the outlets, inserting flow regulators if required. You are now ready to fit and secure the bar mixer.

Mixer Shower Fixing – Exposed Pipework

Fittings designed with no exposed screws and requires only one drill hole through the tiling for each bracket. Flow limiters and filters are also included to simplify future maintenance. Suitable for most types of bar mixer and wall mounted bath/shower mixers with 3/4" BSP fittings including the extensive Triton range.

Ref: UNBMXFIXEX

1. Secure the bracket mounting plates to the wall using the screws provided. Ensure the distance between the mounting plate centres is equal to the distance between the bar mixer inlet centres.
2. Slide the brackets onto the mounting plates and secure using the grub-screw in the base.
3. Slide the nut and olive onto the in-coming pipework and fit the pipework into the bracket. Tighten the nut for a watertight seal.
4. You then simply push-fit the seals into the bracket outlets, inserting flow regulators if required. You are now ready to fit and secure the bar mixer.

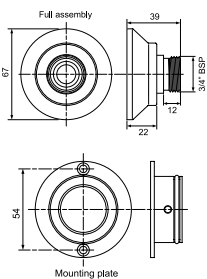

Dimensions given are approximate. For Bar Diverter mixer showers please check suitability.

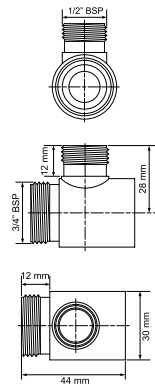

Dimensions given are approximate. For Bar Diverter mixer showers please check suitability.

Mixer Shower Fixing – Exposed Pipe Tails

Fittings designed to leave no exposed thread between the trim and the bar mixer. The push-fit connections make installation even faster they also include flow limiters and filters to simplify future maintenance.

Suitable for most types of bar mixer and wall mounted bath/shower mixers with 3/4" BSP fittings including the extensive Triton range.

Ref: UNBMXFIXBT

1. Complete the pipework to the bracket mounting points, leaving an excess of pipe protruding out of the wall and make good the walls and tiles.
2. Press a push-fit connector onto each pipe, screw the mounting plates onto the connectors and fix in place using the screws provided.
3. A grub screw in the mounting plate secures the connector and you can now seal the joint between the mounting plate and the wall using a suitable sealant.
4. You then simply push-fit the cover trims onto the mounting plates and push-fit the seals into the outlets, inserting flow regulators if required. You are now ready to fit and secure the bar mixer.

Shower specifications

Eden Bar Mixer with Diverter

thermostatic mixer shower

Temperature Control	Thermostatic
Plumbing System Compatibility	Low and high pressure
Inlet Connections	15mm push fit to a 3/4 union
Water Entry Points	Back
Minimum Running Pressure/Flow	0.5 Bar @ 8l/min
Maximum Running Pressure	5 Bar
Maximum Static Pressure	10 Bar
Open Outlet Flow Rate at 0.1 Bar	3.5l/min
Pipe Inlet Centres	150mm
Approvals, Complies with	BS EN 1111, WRAS, TMV2
Guarantee	5 years

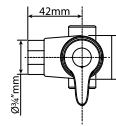
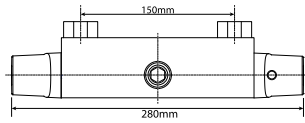

Finish	Code
Chrome	UNEDTHBMDIV

Eden Bath/Shower Mixer

thermostatic mixer shower

Temperature Control	Thermostatic
Plumbing System Compatibility	Low and high pressure
Inlet Connections	3/4" BSP
Water Entry Points	Rising
Outlet Connection	1/2" BSP bottom
Minimum Running Pressure/Flow	0.5 Bar @ 8l/min
Maximum Running Pressure	5 Bar
Maximum Static Pressure	10 Bar
Open Outlet Flow Rate at 0.1 Bar	4l/min
Pipe Inlet Centres	180mm
Approvals, Complies with	BS EN 1111, WRAS, TMV2
Guarantee	5 years

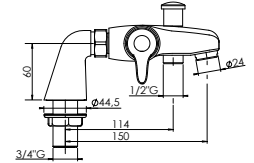
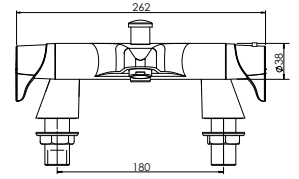

Finish	Code
Chrome	UNEDTHBSM
Chrome	UNEDTHBSMR

Eden Dual Control

thermostatic mixer shower

Temperature Control	Thermostatic
Plumbing System Compatibility	Low and high pressure
Inlet Connections	3/4" BSP
Water Entry Points	Rising, falling, back
Minimum Running Pressure/Flow	0.1 Bar @ 8l/min
Maximum Running Pressure	5 Bar
Maximum Static Pressure	10 Bar
Open Outlet Flow Rate at 0.1 Bar	4.9l/min
Built-In depth	55mm minimum
Approvals, Complies with	BS EN 1111, WRAS, TMV2
Guarantee	5 years

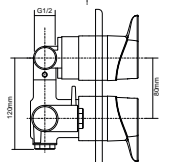
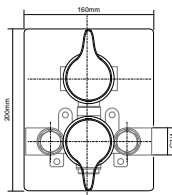

Finish	Code
Chrome	UNEDTHDCDIV
Chrome	UNEDTHDCMX

Eden Built-in & Exposed Concentric

thermostatic mixer shower

Temperature Control	Thermostatic
Plumbing System Compatibility	Low and high pressure
Inlet Connections	15mm compression
Water Entry Points	Rising, falling, back
Minimum Running Pressure/Flow	0.1 Bar @ 8l/min
Maximum Running Pressure	5 Bar
Maximum Static Pressure	10 Bar
Open Outlet Flow Rate at 0.1 Bar	6l/min
Maximum Flow with Flow Limiters Fitted	12l/min max flow (6l/min for Eden Eco)
Pipe Inlet Centres	150mm
Approvals, Complies with	BS EN 1111, WRAS, TMV2
Guarantee	5 years

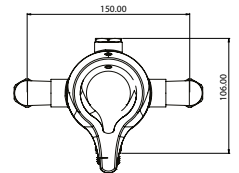
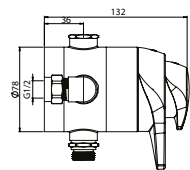

Finish	Code
Chrome	UNEDTHCM
Chrome	ECEOETHCM
Chrome	UNEDTHCMEXT

Eden Built-in & Exposed Sequential

thermostatic mixer shower

Temperature Control	Thermostatic
Plumbing System Compatibility	Low and high pressure
Inlet Connections	15mm compression
Water Entry Points	Rising, falling, back
Minimum Running Pressure/Flow	0.1 Bar @ 8l/min
Maximum Running Pressure	5 Bar
Maximum Static Pressure	10 Bar
Open Outlet Flow Rate at 0.1 Bar	4.8l/min
Built-In depth	50mm minimum
Pipe Inlet Centres	150mm
Approvals, Complies with	BS EN 1111, WRAS, TMV2
Guarantee	5 years

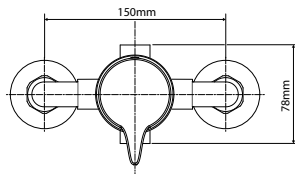
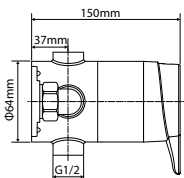

Finish	Code
Chrome	UNEDTHSQM

Eden Bar Mixer

thermostatic mixer shower

Temperature Control	Thermostatic
Plumbing System Compatibility	Low and high pressure
Inlet Connections	15mm push fit to 3/4 union
Water Entry Points	Back
Minimum Running Pressure/Flow	0.1 Bar @ 8l/min
Maximum Running Pressure	5 Bar
Maximum Static Pressure	10 Bar
Open Outlet Flow Rate at 0.1 Bar	3.5l/min
Maximum Flow with Flow Limiters Fitted	12l/min max flow
Pipe Inlet Centres	150mm
Approvals, Complies with	BS EN 1111, WRAS, TMV2
Guarantee	5 years

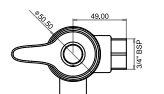
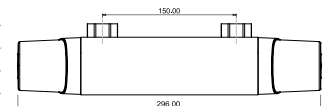

Finish	Code
Chrome	UNEDTHBM

Kensey Dual Control

thermostatic mixer shower

Temperature Control	Thermostatic
Plumbing System Compatibility	Low and high pressure
Inlet Connections	3/4" BSP
Water Entry Points	Rising, falling, back
Outlet Connection	1/2" BSP top
Minimum Running Pressure/Flow	0.1 Bar @ 8l/min
Maximum Running Pressure	5 Bar
Maximum Static Pressure	10 Bar
Open Outlet Flow Rate at 0.1 Bar	4.9l/min
Built-In depth	55mm minimum
Approvals, Complies with	BS EN 1111, WRAS, TMV2
Guarantee	5 years

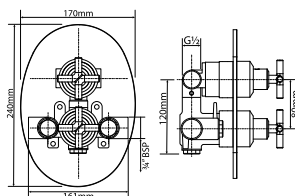

Finish	Code
Chrome	UNKETHDCDIV
Chrome	UNKETHDCMX

Kensey Built-in & Exposed Sequential

thermostatic mixer shower

Temperature Control	Thermostatic
Plumbing System Compatibility	Low and high pressure
Inlet Connections	15mm compression
Water Entry Points	Rising, falling, back
Outlet Connection	1/2" BSP bottom
Minimum Running Pressure/Flow	0.1 Bar @ 8l/min
Maximum Running Pressure	5 Bar
Maximum Static Pressure	10 Bar
Open Outlet Flow Rate at 0.1 Bar	4.8l/min
Maximum Flow with Flow Limiters Fitted	12l/min max flow
Built-In depth	50mm minimum
Pipe Inlet Centres	150mm
Approvals, Complies with	BS EN 1111, WRAS, TMV2
Guarantee	5 years

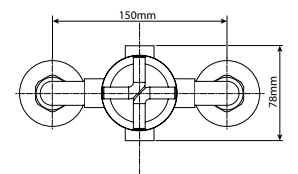
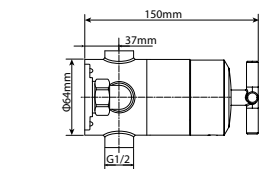

Finish	Code
Chrome	UNKETHSQM

Kensey Built-in & Exposed Concentric

thermostatic mixer shower

Temperature Control	Thermostatic
Plumbing System Compatibility	Low and high pressure
Inlet Connections	15mm compression
Water Entry Points	Rising, falling, back
Outlet Connection	½" BSP bottom
Minimum Running Pressure/Flow	0.1 Bar @ 8l/min
Maximum Running Pressure	5 Bar
Maximum Static Pressure	10 Bar
Open Outlet Flow Rate at 0.1 Bar	6l/min
Maximum Flow with Flow Limiters Fitted	12l/min max flow
Built-in depth	55mm minimum
Pipe Inlet Centres	150mm
Approvals, Complies with	BS EN 1111, WRAS, TMV2
Guarantee	5 years

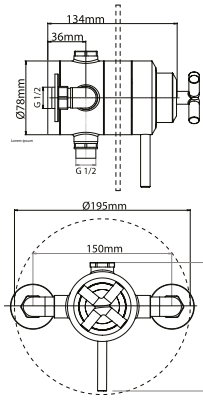

Finish	Code
Chrome	UNKETHCM

Kensey Bar Mixer

thermostatic mixer shower

Temperature Control	Thermostatic
Plumbing System Compatibility	Low and high pressure
Inlet Connections	15mm push fit to a 3/4 union
Water Entry Points	Back
Outlet Connection	½" BSP bottom
Minimum Running Pressure/Flow	0.1 Bar @ 8l/min
Maximum Running Pressure	5 Bar
Maximum Static Pressure	10 Bar
Open Outlet Flow Rate at 0.1 Bar	3.5l/min
Maximum Flow with Flow Limiters Fitted	12l/min max flow
Pipe Inlet Centres	150mm
Approvals, Complies with	BS EN 1111, WRAS, TMV2
Guarantee	5 years

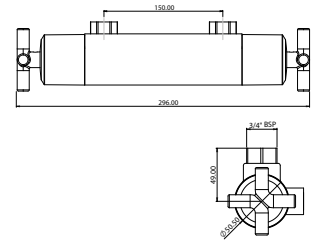

Finish	Code
Chrome	UNKETHBM

Dene Hi-Flo Bar Mixer

thermostatic mixer shower

Temperature Control	Thermostatic
Plumbing System Compatibility	Low and high pressure
Inlet Connections	15mm push fit (fixing to pipe) to ¾" flat face union valve to fixings)
Water Entry Points	Back
Outlet Connection	½" BSP bottom
Minimum Running Pressure/Flow	0.1 Bar @ 8l/min
Maximum Running Pressure	5 Bar
Maximum Static Pressure	10 Bar
Open Outlet Flow Rate at 0.1 Bar	5l/min
Pipe Inlet Centres	150mm
Flow Limiters Fitted	12l/max flow
Approvals, Complies with	BS EN 1111, WRAS, TMV2
Guarantee	5 years

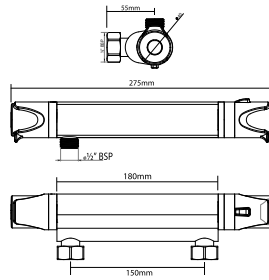

Finish	Code
Chrome	UNDETHBM

Dene Eco Bar Mixer

thermostatic mixer shower

Temperature Control	Thermostatic
Plumbing System Compatibility	Low and high pressure
Inlet Connections	15mm push fit (fixing to pipe) to ¾" flat face union valve to fixings)
Water Entry Points	Back
Outlet Connection	½" BSP bottom
Minimum Running Pressure/Flow	0.1 Bar @ 8l/min
Maximum Running Pressure	5 Bar
Maximum Static Pressure	10 Bar
Open Outlet Flow Rate at 0.1 Bar	5l/min
Pipe Inlet Centres	150mm
Flow Limiters Fitted	6l/max flow
Approvals, Complies with	BS EN 1111, WRAS, TMV2
Guarantee	5 years

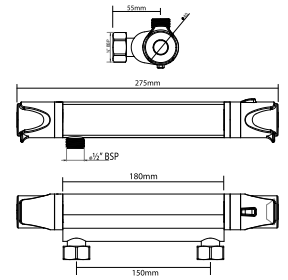

Finish	Code
Chrome	ECODETHBM

Dene Cool Touch Bar Mixer

thermostatic mixer shower

Temperature Control	Thermostatic
Plumbing System Compatibility	Low and high pressure
Inlet Connections	15mm push fit (fixing to pipe) to ¾" flat face union valve to fixings)
Water Entry Points	Back
Outlet Connection	½" BSP bottom
Minimum Running Pressure/Flow	0.1 Bar @ 8l/min
Maximum Running Pressure	5 Bar
Maximum Static Pressure	10 Bar
Open Outlet Flow Rate at 0.1 Bar	3l/min
Pipe Inlet Centres	150mm
Approvals, Complies with	BS EN 1111, WRAS, TMV2
Guarantee	5 years

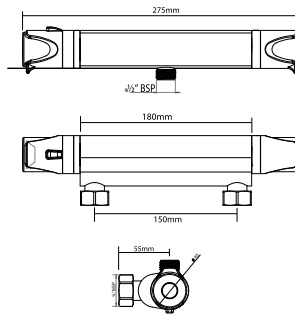

Finish	Code
Chrome	UNDETHBMCT

Dene Bar Mixer with Diverter

thermostatic mixer shower

Temperature Control	Thermostatic
Plumbing System Compatibility	High pressure
Inlet Connections	15mm push fit (fixing to pipe) to ¾" flat face union valve to fixings)
Water Entry Points	Back
Outlet Connection	½" BSP bottom
Minimum Running Pressure/Flow	0.5 Bar @ 8l/min
Maximum Running Pressure	5 Bar
Maximum Static Pressure	10 Bar
Open Outlet Flow Rate at 0.5 Bar	5l/min
Pipe Inlet Centres	150mm
Guarantee	5 years

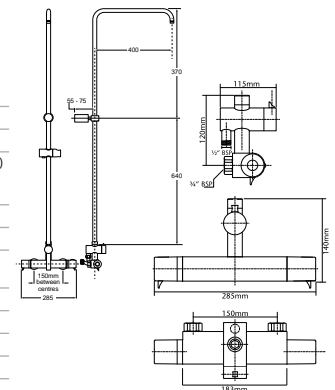

Finish	Code
Chrome	UNDETHBMDIV

Dene Concentric Mixer

thermostatic mixer shower

Temperature Control	Thermostatic
Plumbing System Compatibility	Low and high pressure
Inlet Connections	15mm compression
Water Entry Points	Rising, falling, back
Outlet Connection	½" BSP bottom
Minimum Running Pressure/Flow	0.1 Bar @ 8l/min
Maximum Running Pressure	5 Bar
Maximum Static Pressure	10 Bar
Open Outlet Flow Rate at 0.1 Bar	4.3l/min
Pipe Inlet Centres	150mm
Flow Limiters Fitted	8l/max flow
Approvals, Complies with	WRAS
Guarantee	5 years

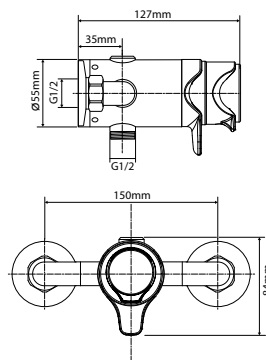

Finish	Code
Chrome	UNDETHXCM

Dene Sequential Mixer

thermostatic mixer shower

Temperature Control	Thermostatic
Plumbing System Compatibility	Low and high pressure
Inlet Connections	15mm compression
Water Entry Points	Rising, falling, back
Outlet Connection	½" BSP bottom
Minimum Running Pressure/Flow	0.1 Bar @ 8l/min
Maximum Running Pressure	5 Bar
Maximum Static Pressure	10 Bar
Open Outlet Flow Rate at 0.1 Bar	3.9l/min
Pipe Inlet Centres	150mm
Flow Limiters Fitted	8l/max flow
Approvals, Complies with	WRAS
Guarantee	5 years

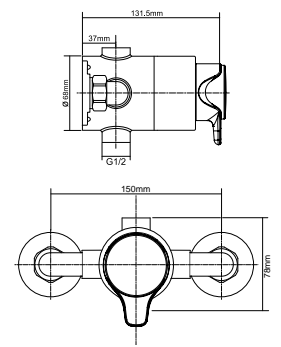

Finish	Code
Chrome	UNDETHXSQM

Shower specifications

Dene Bath/Shower Mixer

mixer shower

Temperature Control	Manual
Plumbing System Compatibility	Low and high pressure
Inlet Connections	3/4" BSP
Water Entry Points	Rising
Outlet Connection	1/2" BSP bottom
Minimum Running Pressure/Flow	0.1 Bar @ 8l/min
Maximum Running Pressure	5 Bar
Maximum Static Pressure	10 Bar
Shower Outlet Flow Rate	10l/min @ 0.1 Bar
Bath Outlet Flow Rate	38l/min @ 1 Bar
Pipe Inlet Centres	180mm
Guarantee	5 years

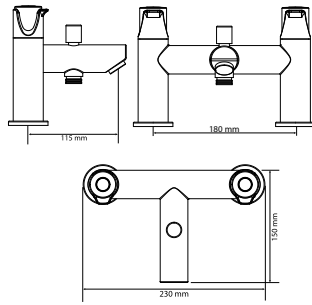

Finish	Code
Chrome	UNDEBSM

EXE Bath/Shower Mixer

mixer shower

Temperature Control	Manual
Plumbing System Compatibility	Low and high pressure
Inlet Connections	3/4" BSP
Water Entry Points	Rising
Outlet Connection	1/2" BSP bottom
Minimum Running Pressure/Flow	0.1 Bar @ 8l/min
Maximum Running Pressure	5 Bar
Maximum Static Pressure	10 Bar
Shower Outlet Flow Rate	9l/min @ 0.1 Bar
Bath Outlet Flow Rate	15l/min @ 0.1 Bar
Pipe Inlet Centres	180mm
Guarantee	5 years

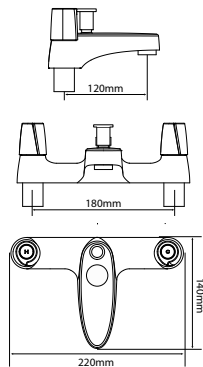

Finish	Code
Chrome	UNEXBSM

EXE Lever Bath/Shower Mixer

mixer shower

Temperature Control	Manual
Plumbing System Compatibility	Low and high pressure
Inlet Connections	3/4" BSP
Water Entry Points	Rising
Outlet Connection	1/2" BSP bottom
Minimum Running Pressure/Flow	0.1 Bar @ 8l/min
Maximum Running Pressure	5 Bar
Maximum Static Pressure	10 Bar
Shower Outlet Flow Rate	9l/min @ 0.1 Bar
Bath Outlet Flow Rate	15l/min @ 0.1 Bar
Pipe Inlet Centres	180mm
Guarantee	5 years

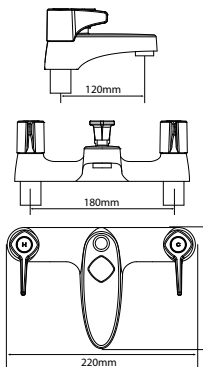

Finish	Code
Chrome	UNEXBSMINC

T450i

Single Impeller Pump

Voltage 230/240v AC	Rating 590W nominal
Plumbing System Compatibility	Gravity cold only
Inlet Connections	15mm push fit
Water Entry Points	Side
Outlet Connection	15mm push fit
Minimum Head Pressure	500mm
Maximum Head Pressure	10m
Maximum Open Outlet Flow Rate at 1.2 Bar	15l/min
Approvals, Complies with	BEAB, CE
Guarantee	1 year

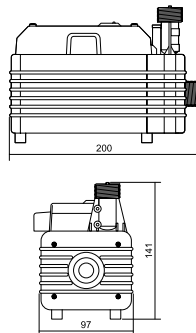

Finish	Code
White/Chrome	T450I00M

EXE Bar Mixer

thermostatic mixer shower

Temperature Control	Thermostatic
Plumbing System Compatibility	Low and high pressure
Inlet Connections	1/2" BSP to 3/4" flat face union
Water Entry Points	Back
Outlet Connection	1/2" BSP bottom
Minimum Running Pressure/Flow	0.1 Bar @ 8l/min
Maximum Running Pressure	5 Bar
Maximum Static Pressure	10 Bar
Open Outlet Flow Rate at 0.1 Bar	5l/min
Approvals, Complies with	BS EN 1111, WRAS, TMV2
Guarantee	2 years

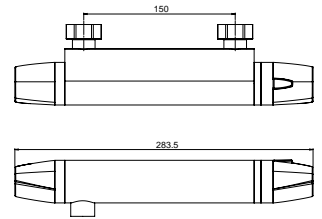

Finish	Code
Chrome	UNEXTHBM

EXE Lever Bar Mixer

thermostatic mixer shower

Temperature Control	Thermostatic
Plumbing System Compatibility	Low and high pressure
Inlet Connections	1/2" BSP to 3/4" flat face union
Water Entry Points	Back
Outlet Connection	1/2" BSP bottom
Minimum Running Pressure/Flow	0.1 Bar @ 8l/min
Maximum Running Pressure	5 Bar
Maximum Static Pressure	10 Bar
Open Outlet Flow Rate at 0.1 Bar	5l/min
Approvals, Complies with	BS EN 1111, WRAS, TMV2
Guarantee	5 years

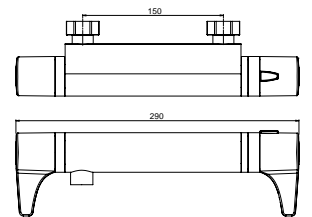

Finish	Code
Chrome	UNEXTHBMINC

T40i

wall mounted booster pump

Voltage 230/240v AC	Rating 590W nominal
Plumbing System Compatibility	Gravity hot and cold only
Inlet Connections	1/2" BSP
Water Entry Points	Bottom
Outlet Connection	1/2" BSP
Minimum Head Pressure	230mm
Maximum Head Pressure	10m
Approvals, Complies with	BEAB, CE
Guarantee	1 year

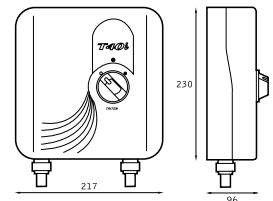

Finish	Code
White	T040004I

T5501

1.2 Bar Twin Impeller Pump

Voltage 230/240v AC	Rating 590W nominal
Plumbing System Compatibility	Gravity hot and cold only
Inlet Connections	15mm push fit
Water Entry Points	Side
Outlet Connection	15mm push fit
Minimum Head Pressure	150mm
Maximum Head Pressure	10m
Maximum Open Outlet Flow Rate at 1.2 Bar	16l/min
Approvals, Complies with	BEAB, CE
Guarantee	1 year

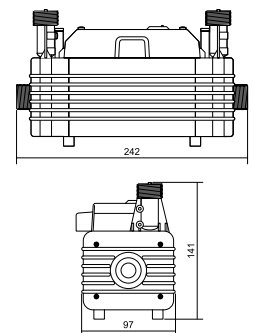

Finish	Code
White/Chrome	T550I00M

Amore

electric shower
8.5kW, 9.5kW (240v)

Temperature Control	Stabilised
Power Ratings	8.5kW, 9.5kW (240v)
Inlet Connection	15mm male compression
Water Entry Points	Top, bottom, side bottom, back (left hand side unit) Bottom, side bottom, back (right hand side unit)
Cable Entry Points	Top, bottom, side bottom, back (left hand side unit)
Outlet Connection	½" BSP
Plumbing System	Cold mains only
Minimum Running Pressure/Flow	1 Bar @ 8 l/min
Maximum Static Pressure	10 Bar
Surface Mounted Only	
Approvals, Complies with	BEAB, CE, BSI Kitemark, WRAS
Guarantee	2 years

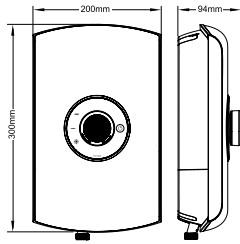

Finish	Power	Code
Gloss Black	8.5kW	ASPAM08GSBLK
Gloss Black	9.5kW	ASPAM09GSBLK
Gloss White	8.5kW	ASPAM08GSWHT
Gloss White	9.5kW	ASPAM09GSWHT
Brushed Steel	8.5kW	ASPAM08BRSTL
Brushed Steel	9.5kW	ASPAM09BRSTL

To see all finishes and for further details please see page 26

Touch

electric shower
8.5kW and 9.5kW (240v)

Temperature Control	Stabilised
Power Ratings	8.5kW, 9.5kW (240v)
Inlet Connection	15mm compression
Water Entry Points	Top, bottom, back (left hand side unit) Bottom, back (right hand side unit)
Cable Entry Points	Top, bottom, back (left hand side unit) Bottom (right hand side unit)
Outlet Connection	½" BSP
Plumbing System	Cold water only
Minimum Running Pressure/Flow	1 Bar @ 8 l/min
Maximum Static Pressure	10 Bar
Surface Mounted Only	
Approvals, Complies with	BEAB, CE, BSI Kitemark
Guarantee	2 years

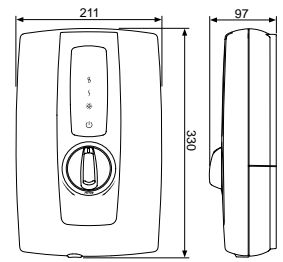

Finish	Power	Code
White	8.5kW	ASPTOU08WHT
White	9.5kW	ASPTOU09WHT

T300si

remote electric shower
8.5kW, 9.5kW and 10.5kW (240v)

Temperature Control	Stabilised
Power Ratings	8.5kW, 9.5kW, 10.5kW (240v)
Inlet Connection	15mm compression
Water Entry Points	Bottom, back (right hand side unit)
Cable Entry Points	Top, back (right hand side unit)
Outlet Connection	½" BSP
Plumbing System	Cold water only
Minimum Running Pressure/Flow	1 Bar @ 8 l/min and 1.5 Bar @ 11 l/min for 10.5kW
Maximum Static Pressure	10 Bar
Surface Mounted Only	
Approvals, Complies with	BEAB, CE, BSI Kitemark
Guarantee	2 years

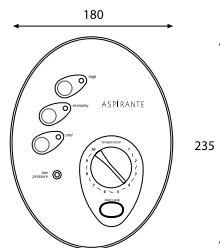

Finish	Power	Code
White/Chrome	8.5kW	ASP3008SI
White/Chrome	9.5kW	ASP3009SI
White/Chrome	10.5kW	ASP3001SI

Aspirante Wireless

remote electric shower
8.5kW, 9.5kW and 10.5kW (240v)

Temperature Control	Stabilised
Power Ratings	8.5kW, 9.5kW, 10.5kW (240v)
Inlet Connection	15mm compression
Water Entry Points	Bottom, back (right hand side of unit)
Cable Entry Points	Back, top (right hand side of unit)
Outlet Connection	1/2" BSP
Plumbing System	Cold water only
Minimum Running Pressure/Flow	1 Bar @ 8 l/min and 1.5 Bar @ 11 l/min for 10.5kW
Maximum Static Pressure	10 Bar
Surface Mounted Only	
Approvals, Complies with	BEAB, CE, BSI Kitemark
Guarantee	2 years

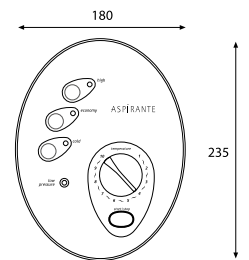

Finish	Power	Code
Chrome	8.5kW	SP3008SI
Chrome	9.5kW	SP3009SI
Chrome	10.5kW	SP3001SI

T80 Pro-Fit

electric shower
7.5kW, 8.5kW, 9.5kW and 10.5kW (240v)

Temperature Control	Stabilised
Power Ratings	7.5kW, 8.5kW, 9.5kW, 10.5kW (240v)
Inlet Connection	15mm compression
Water Entry Points	Top, bottom, side bottom, back (left hand side unit) Top, bottom, side bottom, back (right hand side unit)
Cable Entry Points	Top, bottom, side bottom, back (left hand side unit) Top, bottom, side bottom, back (right hand side unit)
Outlet Connection	½" BSP
Plumbing System	Cold water only
Minimum Running Pressure/Flow for full performance*	1 bar at 8l/min 1.5 bar at 11l/min for 10.5kW*
Maximum Static Pressure	10 Bar
Surface Mounted Only	
Approvals, Complies with	BEAB, CE, BSI Kitemark, WRAS
Guarantee	2 years

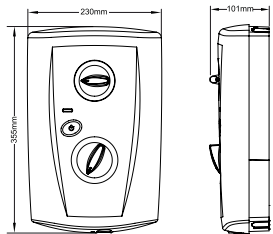

Finish	Power	Code
White	7.5kW	SP8007PF
White	8.5kW	SP8008PF
White	9.5kW	SP8009PF
White	10.5kW	SP8001PF
White	8.5kW	ECO8008PF

To see all finishes and for further details please see page 30

*At running pressure/flow 0.7 Bar at 8 l/min (1.2 Bar at 11 l/min for 10.5kW) the shower will continue to operate at a reduced performance.

T80Z Fast-Fit

electric shower
7.5kW, 8.5kW, 9.5kW and 10.5kW (240v)

Temperature Control	Stabilised
Power Ratings	7.5kW, 8.5kW, 9.5kW, 10.5kW (240v)
Inlet Connection	15mm compression
Water Entry Points	Top, bottom, side bottom, back (left hand side unit) Top, bottom, side bottom, back (right hand side unit)
Cable Entry Points	Top, bottom, back (left hand side unit) Top, bottom, back (right hand side unit)
Outlet Connection	½" BSP
Plumbing System	Cold water only
Minimum Running Pressure/Flow for full performance*	1 bar at 8l/min 1.5 bar at 11l/min for 10.5kW*
Maximum Static Pressure	10 Bar
Surface Mounted Only	
Approvals, Complies with	BEAB, CE, BSI Kitemark
Guarantee	2 years

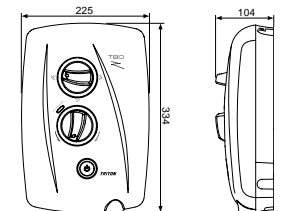

Finish	Power	Code
Chrome	8.5kW	SP8CHR8ZFF
Chrome	9.5kW	SP8CHR9ZFF
Chrome	10.5kW	SP8CHR1ZFF
White/Chrome	7.5kW	SP8007ZFF
White/Chrome	8.5kW	SP8008ZFF
White/Chrome	9.5kW	SP8009ZFF
White/Chrome	10.5kW	SP8001ZFF
White/Chrome	8.5kW	ECO8008ZFF

*At running pressure/flow 0.7 Bar at 8 l/min (1.2 Bar at 11 l/min for 10.5kW) the shower will continue to operate at a reduced performance.

T80Z Thermostatic Fast-Fit

electric shower
8.5kW, 9.5kW & 10.5kW (240v)

Temperature Control	Thermostatic
Power Ratings	8.5kW, 9.5kW, 10.5kW
Inlet Connection	15mm compression
Water Entry Points	Top, bottom, side bottom, back (left hand side of unit) Top, bottom, side bottom, back (right hand side of unit)
Cable Entry Points	Top, bottom, back (left hand side of unit) Top, bottom, back (right hand side of unit)
Outlet Connection	½" BSP
Plumbing System	Cold water only
Minimum Running Pressure/Flow for full performance*	1.0 Bar @ 8 l/min 1.5 Bar @ 11 l/min for 10.5kW
Maximum Static Pressure	10 Bar
Surface Mounted Only	
Approvals, Complies with	BEAB, CE, BSI Kitemark
Guarantee	2 years

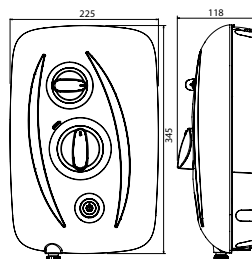

Finish	Power	Code
White/Chrome	8.5kW	SP8008ZFFTHM
White/Chrome	9.5kW	SP8009ZFFTHM
White/Chrome	10.5kW	SP8001ZFFTHM

For further details please see page 31

*At running pressure/flow 0.7 Bar at 8 l/min (1.2 Bar at 11 l/min for 10.5kW) the shower will continue to operate at a reduced performance.

T80si Pumped

electric pumped shower
8.5kW & 9.5kW

Temperature Control	Stabilised
Power Ratings	8.5kW, 9.5kW
Inlet Connection	15mm push fit
Water Entry Points	Top, bottom, back (left hand side of unit)
Cable Entry Points	Top, bottom, back (left hand side of unit)
Outlet Connection	½" BSP
Plumbing System	Cold water cistern only
Minimum Running Pressure/Flow for full performance*	80mm @ 8 l/min
Maximum Static Pressure	10m
Surface Mounted Only	
Approvals, Complies with	BEAB, CE, BSI Kitemark
Guarantee	1 years

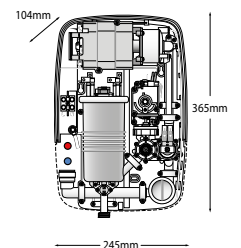

Finish	Power	Code
White/Chrome	8.5kW	SP8P08SI
White/Chrome	9.5kW	SP8P09SI

Shower specifications

T70Z

electric shower

Temperature Control	Stabilised
Power Ratings	7.5kW, 8.5kW
Inlet Connection	15mm compression
Water Entry Points	Left - Top, bottom, back. Right Bottom, back
Cable Entry Points	Top, bottom, back
Outlet Connection	½" BSP
Plumbing System	Cold water only
Minimum Running Pressure/Flow	1 Bar @ 8 l/min
Maximum Static Pressure	10 Bar
Surface Mounted Only	
Approvals, Complies with	BEAB, CE, BSI Kitemark
Guarantee	2 years

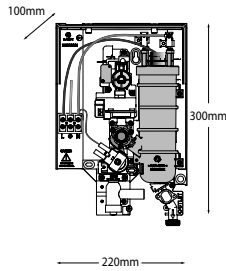

Finish	Power	Code
White/Chrome	7.5kW	SP7007Z
White/Chrome	8.5kW	SP7008Z

T75

electric shower

Temperature Control	Stabilised
Power Ratings	8.5kW, 9.5kW
Inlet Connection	15mm compression
Water Entry Points	Left - top, side, back, bottom. Right - side, back, bottom
Cable Entry Points	Left - top, back, bottom
Outlet Connection	½" BSP
Plumbing System	Cold water only
Minimum Running Pressure/Flow	1 Bar @ 8 l/min
Maximum Static Pressure	10 Bar
Surface Mounted Only	
Approvals, Complies with	BEAB, CE, BSI Kitemark
Guarantee	2 years

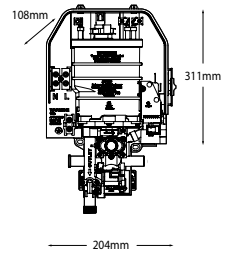

Finish	Power	Code
White/Chrome	8.5kW	SP75085C
White/Chrome	9.5kW	SP75095C

T90XR

pumped electric shower
8.5kW & 9.5kW

Temperature Control	Pumped electric stabilised
Power Ratings	8.5kW, 9.5kW
Inlet Connection	15mm compression
Water Entry Points	Top, bottom, back (left hand side of unit)
Cable Entry Points	Top, bottom, back (left hand side of unit)
Outlet Connection	½" BSP
Plumbing System	Cold water cistern only
Minimum Head Pressure	75mm
Maximum Head Pressure	10m
Surface Mounted Only	
Approvals, Complies with	BEAB, CE, BSI Kitemark
Guarantee	1 year

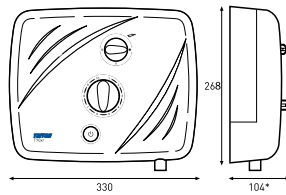

Finish	Power	Code
White/Chrome	8.5kW	SP900851
White/Chrome	9.5kW	SP900951

Aspirante Power Shower

thermostatic power shower

Temperature Control	Thermostatic
Voltage 230/240v Ac.	Rating 150W nominal
Plumbing System Compatibility	Low pressure gravity
Inlet Connections	15mm push fit
Water Entry Points	Rising, falling, back
Outlet Connection	½" BSP
Minimum Head Pressure	75mm
Maximum Head Pressure	10m
Maximum Open Outlet Flow Rate	14l/min
Approvals, Complies with	BEAB, CE, BSI Kitemark
Guarantee	1 year

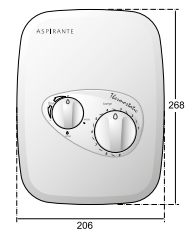

Finish	Code
Chrome	ASP2000THM

AS2000XT

thermostatic power shower

Temperature Control	Thermostatic
Voltage 230/240v Ac.	Rating 150W nominal
Plumbing System Compatibility	Low pressure gravity
Inlet Connections	15mm push fit
Water Entry Points	Rising, falling, back
Outlet Connection	1/2" BSP
Minimum Head Pressure	75mm
Maximum Head Pressure	10m
Maximum Open Outlet Flow Rate	14l/min
Approvals, Complies with	BEAB, CE, BSI Kitemark
Guarantee	1 year

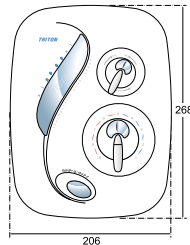

Finish	Code
White/Chrome	TAS2000XTHM

AS2000X Manual IPS

manual power shower

Temperature Control	Manual
Voltage 230/240v AC	Rating 150W nominal
Plumbing System Compatibility	Low pressure gravity
Inlet Connections	15mm push fit
Water Entry Points	Rising, falling, back
Outlet Connection	½ BSP
Minimum Head Pressure	75mm
Maximum Head Pressure	10m
Maximum Open Outlet Flow Rate	14l/min
Approvals, Complies with	BEAB, CE, BSI Kitemark
Guarantee	1 year

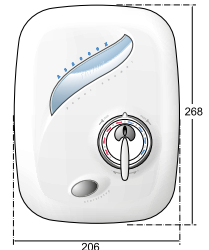

Finish	Code
White/Chrome	TAS2000XMAN

T30i

hand wash unit

Temperature Control	Stabilised
Power Ratings	3kW, 7kW
Inlet Connection	15mm compression
Water Entry Points	Bottom
Cable Entry Points	Top, bottom, back
Outlet Connection	½" BSP
Plumbing System	Cold water only
Minimum Running Pressure/Flow	1 Bar @ 8 l/min
Maximum Static Pressure	10 Bar
Surface Mounted Only	
Approvals, Complies with	BEAB, CE, BSI Kitemark
Guarantee	1 year

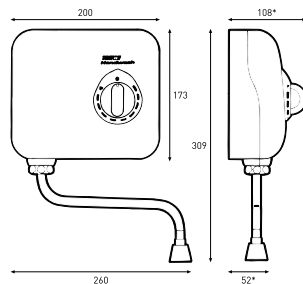

Finish	Power	Code
White/Chrome	3kW	T3A3034i
White/Chrome	7kW	T3A7074i

Elina Inclusive TMV3 Concentric Built-in Mixer

thermostatic mixer shower

Temperature Control	Thermostatic
Plumbing System Compatibility	Low and high pressure
Inlet Connections	15mm compression
Water Entry Points	Rising, falling, back
Outlet Connection	½" BSP top or bottom
Minimum Running Pressure/Flow	0.1Bar @ 8l/min
Maximum Running Pressure	5 Bar
Open Outlet Flow Rate at 0.1Bar	7l/min
Maximum Flow with Flow Limiters Fitted	12l/min
Approvals, Complies with	WRAS, TMV3
TMV3 Designation	HP-5
Built-In depth (Built-In only)	55mm minimum
Guarantee	5 years

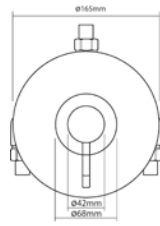

Finish	Code
Chrome	ELICMINCBTVO*
Chrome	ELICMINCBT

*Valve only

Elina Inclusive TMV3 Concentric Exposed Mixer

thermostatic mixer shower

Temperature Control	Thermostatic
Plumbing System Compatibility	Low and high pressure
Inlet Connections	15mm compression
Water Entry Points	Rising, falling, back
Outlet Connection	½" BSP top or bottom
Minimum Running Pressure/Flow	0.1Bar @ 8l/min
Maximum Running Pressure	5 Bar
Open Outlet Flow Rate at 0.1Bar	7l/min
Maximum Flow with Flow Limiters Fitted	12l/min
Approvals, Complies with	WRAS, TMV3
TMV3 Designation	HP-5
Guarantee	5 years

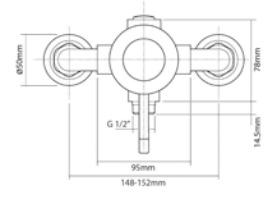

Finish	Code
Chrome	ELICMINCEXVO*
Chrome	ELICMINCEX

*Valve only

Elina Inclusive TMV3 Sequential Built-in Mixer

thermostatic mixer shower

Temperature Control	Thermostatic
Plumbing System Compatibility	Low and High pressure
Inlet Connections	15mm compression to flat face union
Water Entry Points	Rising, falling, back
Outlet Connection	½" BSP top or bottom
Minimum Running Pressure/Flow	0.1Bar @ 8l/min
Maximum Running Pressure	5 Bar
Maximum Static Pressure	10 Bar
Open Outlet Flow Rate at 0.1Bar	6l/min
Maximum Flow with Flow Limiters Fitted	12l/min
Pipe Inlet Centres	150mm
Approvals, Complies with	WRAS, TMV3
Built-In depth (Built-In only)	55mm minimum
Guarantee	5 years

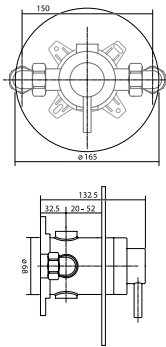

Finish	Code
Chrome	ELITMV3BTSL

Elina Inclusive TMV3 Sequential Exposed Mixer

thermostatic mixer shower

Temperature Control	Thermostatic
Plumbing System Compatibility	Low and High pressure
Inlet Connections	15mm compression to flat face union
Water Entry Points	Rising, falling, back
Outlet Connection	½" BSP top or bottom
Minimum Running Pressure/Flow	0.1Bar @ 8l/min
Maximum Running Pressure	5 Bar
Maximum Static Pressure	10 Bar
Open Outlet Flow Rate at 0.1Bar	6l/min
Maximum Flow with Flow Limiters Fitted	12l/min
Pipe Inlet Centres	150mm
Approvals, Complies with	WRAS, TMV3
Built-In depth (Built-In only)	55mm minimum
Guarantee	5 years

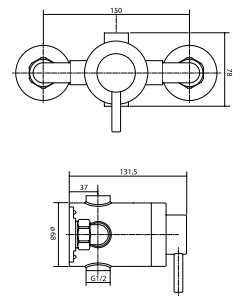

Finish	Code
Chrome	ELITMV3EXSL

Elina Thermo TMV2 Dual Control with Diverter

Temperature Control	Thermostatic
Plumbing System Compatibility	Low and High pressure
Inlet Connections	¾" BSP
Water Entry Points	Rising, falling, back
Outlet Connection	½" BSP
Minimum Running Pressure/Flow	0.1Bar @ 8l/min
Maximum Running Pressure	5 Bar
Maximum Static Pressure	10 Bar
Open Outlet Flow Rate at 0.1Bar	5.4l/min
Maximum Flow with Flow Limiters Fitted	8l/min
Approvals, Complies with	B5 EN 1111, TMV2, WRAS
Built-In depth (Built-In only)	65mm minimum
Guarantee	5 years

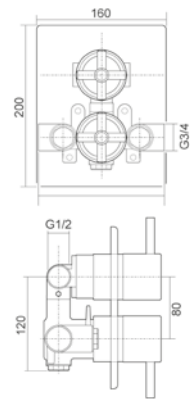

Finish	Code
Chrome	ELIHTDCDIV

Elina inclusive TMV3 Bar Mixer

Temperature Control	Thermostatic
Plumbing System Compatibility	Low and High pressure
Inlet Connections	15mm push fit
Outlet Connection	½" BSP bottom
Minimum Running Pressure/Flow	0.1Bar @ 8l/min
Maximum Running Pressure	5 Bar
Maximum Static Pressure	10 Bar
Open Outlet Flow Rate at 0.1Bar	3.5l/min
Maximum Flow with Flow Limiters Fitted	12l/min
Pipe Inlet Centres	150mm
Approvals, Complies with	TMV3, WRAS
Guarantee	5 years

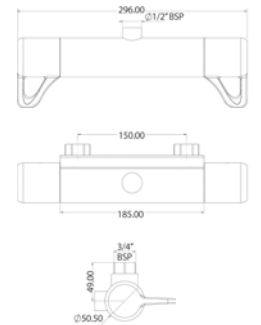

Finish	Code
Chrome	ELIHTBMINC3
Chrome	ELIHTBMINC3BOT*

*With grab kit

Omicare Style

thermostatic electric shower
8.5kW and 9.5kW (240v)

Temperature Control	Thermostatic
Power Ratings	8.5KW, 9.5KW (240v)
Inlet Connection	15mm compression
Water Entry Points	Top, bottom, back (right hand side of unit)
Cable Entry Points	Top, top left, bottom, back (right hand side of unit)
Outlet Connection	½" BSP
Plumbing System Compatibility	Mains cold water only
Minimum Running Pressure/Flow	0.5 Bar at 8l/min*
Maximum Static Pressure	10 Bar
Surface Mounted Only	
Approvals, Complies with	BEAB, BEAB CARE, CE, BSI Kitemark
Guarantee	2 years

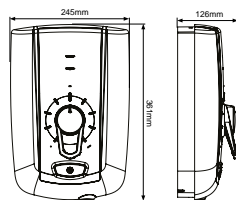

Product	Power	Code
with Extended Kit	8.5KW	CINCSTY08W
with Extended Kit	9.5KW	CINCSTY09W
with Grab Kit	8.5KW	CINCSTY08WGRB
with Grab Kit	9.5KW	CINCSTY09WGRB

*Recommend minimum running pressure/flow for full performance 1 bar @8l/min

Omicare Design

thermostatic electric shower
8.5kW and 9.5kW (240v)

Temperature Control	Thermostatic
Power Ratings	8.5KW, 9.5KW (240v)
Inlet Connection	15mm compression
Water Entry Points	Top, bottom, back (right hand side of unit)
Cable Entry Points	Top, top left, bottom, back (right hand side of unit)
Outlet Connection	½" BSP
Plumbing System Compatibility	Mains cold water only
Minimum Running Pressure/Flow	0.5 Bar at 8l/min*
Maximum Static Pressure	10 Bar
Surface Mounted Only	
Approvals, Complies with	BEAB, BEAB CARE, CE, BSI Kitemark, RNIB
Guarantee	2 years

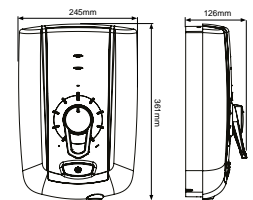

Product	Power	Code
with Extended Kit	8.5KW	CINCDES08W
with Extended Kit	9.5KW	CINCDES09W
with Grab Kit	8.5KW	CINCDES08WGRB
with Grab Kit	9.5KW	CINCDES09WGRB

*Recommend minimum running pressure/flow for full performance 1 bar @8l/min

Shower specifications

T150+

thermostatic electric shower
8.5kW and 9.5kW (240v)

Temperature Control	Thermostatic
Power Ratings	8.5kW, 9.5kW (240v)
Inlet Connection	15mm compression
Water Entry Points	Top, bottom, back (right hand side of unit)
Cable Entry Points	Top, bottom, back (right hand side of unit)
Outlet Connection	1/2" BSP
Plumbing System	Cold mains only
Minimum Running Pressure/Flow	1 Bar @ 8l/min
Maximum Static Pressure	10 Bar
Surface Mounted Only	
Approvals, Complies with	BEAB, BEAB CARE, CE, BSI Kitemark
Guarantee	2 years

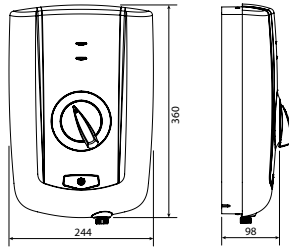

Finish	Power	Code
White/Chrome	8.5kW	SP1508WP
White/Chrome	9.5kW	SP1509WP

T150Z Pumped

thermostatic electric shower
8.5kW and 9.5kW (240v)

Temperature Control	Thermostatic pumped electric
Power Ratings	8.5kW, 9.5kW (240v)
Inlet Connection	15mm compression
Water Entry Points	Top, bottom, back (right hand side of unit)
Cable Entry Points	Top, bottom, back (right hand side of unit)
Outlet Connection	1/2" BSP
Plumbing System	Cold water cistern only
Minimum Head Pressure	75mm
Maximum Head Pressure	10m
Surface Mounted Only	
Approvals, Complies with	BEAB, BEAB CARE, CE, BSI Kitemark
Guarantee	2 years

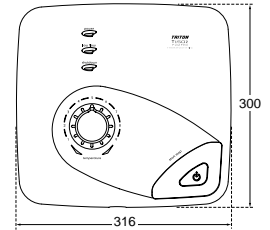

Finish	Power	Code
Chrome	8.5kW	SPSGPE08WC
Chrome	9.5kW	SPSGPE09WC

Safeguard Pumped Care

thermostatic electric shower
8.5kW and 9.5kW (240v)

Temperature Control	Thermostatic Pumped Electric
Power Ratings	8.5kW, 9.5kW (240v)
Inlet Connection	15mm compression
Water Entry Points	Top, bottom, back (right hand side of unit)
Cable Entry Points	Top, bottom, back (right hand side of unit)
Outlet Connection	1/2" BSP
Plumbing System Compatibility	Cold water cistern only
Minimum Head Pressure	75mm
Maximum Head Pressure	10m
Surface Mounted Only	
Approvals, Complies with	BEAB, BEAB CARE, RNIB, CE, BSI Kitemark
Guarantee	2 years

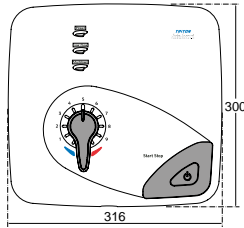

Finish	Power	Code
White/Chrome	8.5kW	CSGPE08WC
White/Chrome	9.5kW	CSGPE09WC

Safeguard+

thermostatic electric shower
8.5kW and 9.5kW (240v)

Temperature Control	Thermostatic
Power Ratings	8.5kW, 9.5kW (240v)
Inlet Connection	15mm compression
Water Entry Points	Top, bottom, back (right hand side of unit)
Cable Entry Points	Top, top left, bottom, back (right hand side of unit)
Outlet Connection	1/2" BSP
Plumbing System Compatibility	Mains cold water only
Minimum Running Pressure/Flow	0.5 Bar at 8l/min*
Maximum Static Pressure	10 Bar
Surface Mounted Only	
Approvals, Complies with	BEAB, BEAB CARE, RNIB, CE, BSI Kitemark
Guarantee	2 years

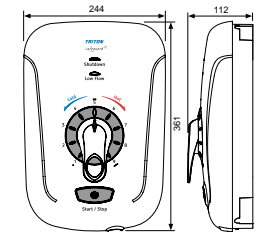

Product	Power	Code
With Grab Rail White/Chrome	8.5kW	CSGP08WGRB
With Grab Rail & Remote White/Chrome	8.5kW	CSGP08WGRBSS
Standard Kit White/Chrome	8.5kW	CSGP08WC
Standard Kit White/Chrome	9.5kW	CSGP09WC
Standard Kit & Remote White/Chrome	8.5kW	CSGP08WRSS

*Recommend minimum running pressure/flow for full performance 1 bar @8l/min

H₂O_{ST} Digital Shower

Finish	Code
Single outlet mixer with controller	HOSDMS
Multi outlet mixer with controller	HOSDMM
Single outlet pumped mixer with controller	HOSDMSPP
Multi outlet pumped mixer with controller	HOSDMMPP
Guarantee	5 years

HOST Digital Mixer (HP)

Connections (mixer)	Water
	Push fit with isolation valves 15mm female push fit
Electric	Flying lead (1m supplied fitted) Fused spur
Wireless	968 MHz 3x AA batteries (lithium supplied)
or Wired	12V 3 core data cable 4.2mm dia cable (10m supplied)
Power supply	Max 240V ac (50Hz) 56W
Running pressure	Max 5 bar Min 1 bar

HOST Digital Mixer Pumped (LP)

Connections (mixer)	Water
	Push fit with isolation valves 15mm female push fit
Electric	Flying lead (1m supplied fitted) Fused spur
Wireless	968 MHz 3x AA batteries (lithium supplied)
or Wired	12V 3 core data cable 4.2mm dia cable (10m supplied)
Power supply	2240V ac (50Hz) 123W
Running pressure	1 bar 0.01 bar (100mm)

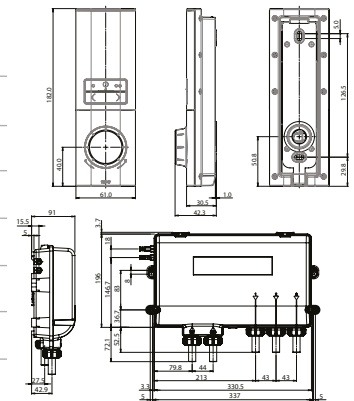

Electric Requirements

CIRCUIT PROTECTION			
Power rating @ 240V	Power rating @ 230V	MCB protection rating	Cartridge Fuse
7.5kW	6.9kW	32A	35A
8.5kW	7.9kW	40A	45A
9.5kW	8.8kW	40/45A	45A
10.5kW	9.6kW	45A	45A

Note: Please note all kW stated throughout the guide are at 240V.

Twin and earth PVC Insulated cable Current carrying capacity		
Installed in an insulated wall	In conduit trunking	Clipped direct or buried in a non-insulated wall
6mm ² = 32A	6mm ² = 32A	6mm ² = 46A
10mm ² = 43A	10mm ² = 52A	10mm ² = 63A
16mm ² = 57A	16mm ² = 69A	16mm ² = 85A

Note: Cable selection is dependent on derating factors
*10 mm² cable must be used on all 10.5kW rated chrome showers

Instantaneous electric shower performance

Temperature/flow rate
Note: The approximate temperatures indicated are based on 0°C ambient incoming water temperature. This can vary between 3°C and 23°C depending on weather conditions.

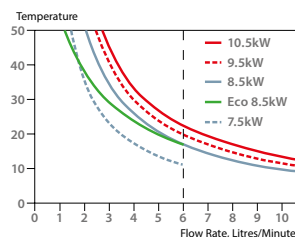

Typical Suitable Installations – Electric showers

Fig 1. Electric Shower Mains Fed Installation

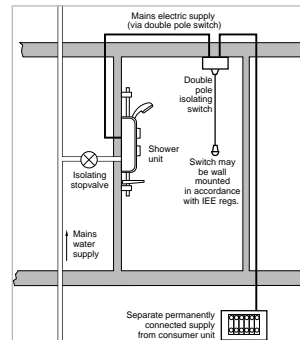

Suitable for the following systems.
For product compatibility, look for the Cold Mains icon as shown.

Fig 2. Digital Electric Shower Installation

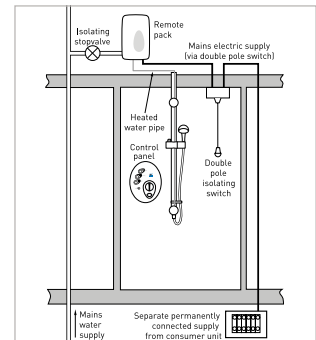

Suitable for the following systems.
For product compatibility, look for the Cold Mains icon as shown.

Typical Suitable Installations – Pumped showers (cistern fed cold only)

Fig 3. Pumped Electric Installation

Suitable for the following systems.



For product compatibility, look for the Low Pressure icon as shown.

WARNING! Under no circumstances must the pumped electric shower be connected directly to the mains water supply.

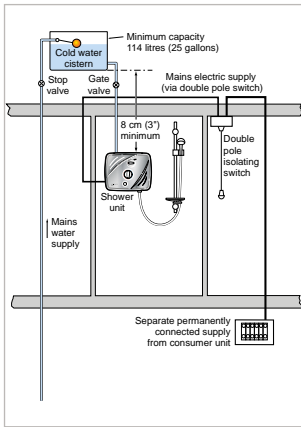

Fig 4. Electric with a Pump Installation

WARNING! Under no circumstances must the T450I pump be connected directly to Satellites HP and LP Mixing Units, Safeguard+, T150Z, Aspirante Power Shower, AS2000XT, AS2000X.

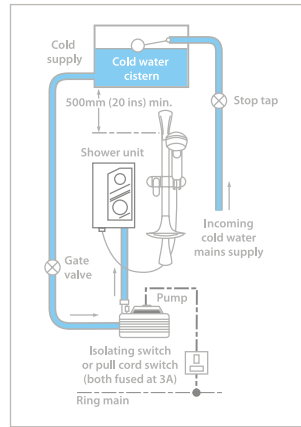
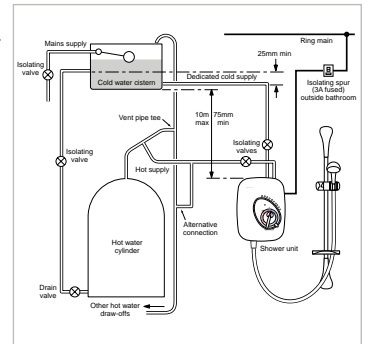

Fig 5. Pumped Power Shower Installation (Gravity Fed System)

Suitable for the following systems.



For product compatibility, look for the Low Pressure icon as shown.



Typical Suitable Installations – High Pressure Digital Mixers

Fig 6. Digital Mixer Installation (Instantaneous Gas Heated Systems e.g. Combination Boilers)

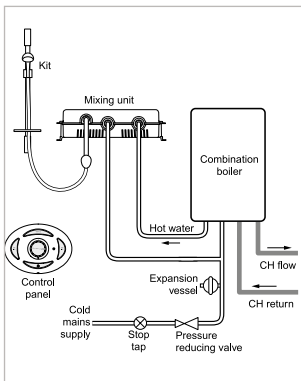

Fig 7. Digital Mixer Installation (Unvented Mains Pressure System)

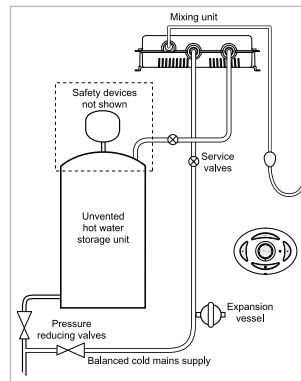
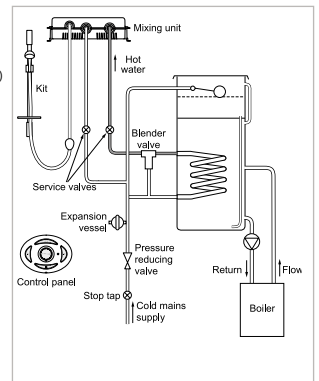

Fig 8. Digital Mixer Installation (Mains Pressurised Thermal Store Systems)

Suitable for the following systems.



For product compatibility, look for the High Pressure icon as shown.



Typical Suitable Installations – Low Pressure Mixer showers

Fig 9. Conventional Low Pressure Mixer Installation (Gravity Fed System)

Suitable for the following systems.



For product compatibility, look for the Low Pressure and All Systems Pressure icons as shown.

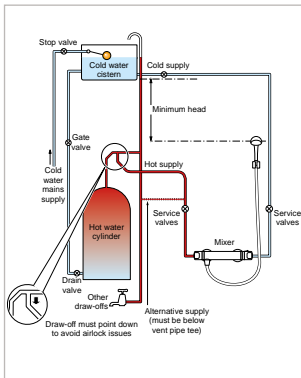

Fig 10. Low Pressure Mixer with a Pump Installation (Gravity Fed System)

Suitable for the following systems.



For product compatibility, look for the Low Pressure icon as shown.

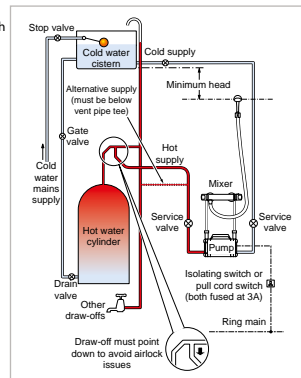
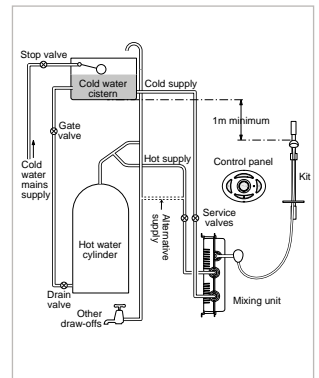

Fig 11. Low Pressure Digital Mixer Installation (Gravity Fed System)

Suitable for the following systems.



For product compatibility, look for the Low Pressure icon as shown.



Typical Suitable Installations – High Pressure Mixer showers

Fig 12. Conventional High Pressure Mixer Installation (Instantaneous Gas Heated System e.g. Combination Boilers)

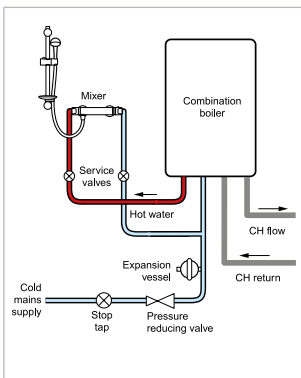

Fig 13. Conventional High Pressure Mixer Installation (Unvented Mains Pressure System)

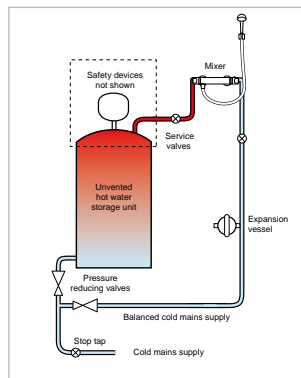
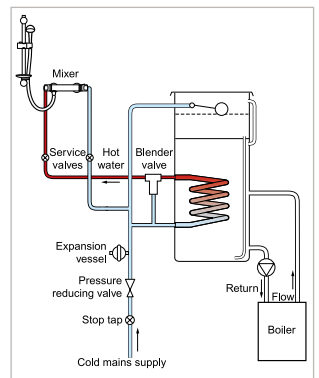

Fig 14. Conventional High Pressure Mixer Installation (Mains Pressurised Thermal Store Systems)

Suitable for the following systems.



For product compatibility, look for the High Pressure and All Systems Pressure icons as shown.



Triton

Triton Road
Nuneaton
Warwickshire
CV11 4NR

Installer Hotline:
+44 (0) 2476 372 222

Customer Services:
+44 (0) 2476 378 320

Email:
technical@tritonshowers.co.uk

Website:
tritonshowers.co.uk

Brochure enquiries:
+44 (0) 24 7632 4460

Triton Showers is a division of
Norcross Group (Holdings) Limited.
Triton, Triton Road, Nuneaton,
Warwickshire CV11 4NR

LITBROCHSEPT17

It is our policy to improve the design and
specification of our products and we reserve
the right to depart from the design given without
prior notice. All information in this brochure may be
subject to change after the date of printing. E&OE

