

HAVEN PLUS SHOWERS

www.roman-showers.com





Roman's Haven Plus range of Showers offers you all the qualities you would expect from the Roman Brand - for complete peace of mind. The innovative and affordable Haven designs are backed by over 35 years of showering experience, offering high quality products complete with a comprehensive after sales service.

MANUFACTURING:

All Haven products are manufactured in Roman's UK Manufacturing Plant and Headquarters. All Haven products are designed to offer the ultimate in quality, precision and craftsmanship. All Roman's manufacturing processes are carried out at our UK Manufacturing Plant and Headquarters and meet and exceed approved UK and European testing standards.

BRANDING:

Roman is a reputable and well established UK Brand, now supplying showering products all over the World. Our foundations are strongly rooted in; innovative design, manufacture, quality and customer service. Roman has achieved the leading position in the Market place by consistent and creative product innovation and has produced growth across all UK Market sectors and strong growth in 55 International Markets. Our products are used in some of the finest hotels Worldwide.

CUSTOMER SERVICE:

Roman has an in-house customer support network, who are there to offer advice and support for each purchase at every stage; from initial enquiry through to after sales care advice. Roman employs over 20 full time members of staff in our Customer Support Centre and over 40 Technical Service Representatives nationwide who all receive comprehensive training on the manufacture and installation of Roman's collection of products.

PRODUCT DESIGN & INNOVATION:

Innovation and exceptional product design differentiates Roman from the competition. Our products and ranges have won multiple awards for innovation and design. Roman employs a dedicated in-house Design Team who are based in our Design Centre.

TEN YEAR GUARANTEE:

For complete peace of mind, all Haven shower enclosures and bath screens are accompanied by a ten year guarantee.

ROUTING AND DELIVERIES:

With a dedicated in-house Logistics Division we can efficiently route and deliver all Haven products offering a first class delivery service.

ROMAN ULTRA CARE:

Winner of the House Beautiful 'Best Cleaning Product' Award 2009 Roman's award winning Ultra Care system gives the care and protection your shower enclosure deserves to keep its long lasting sparkle. Roman Ultra Care is pre-coated onto your enclosure or bath screen to protect the glass. It is also then supplied in a bottle so you can top up this protection as part of your cleaning routine. The more you apply the formula, the more you protect your shower enclosure. Roman Ultra Care cleverly and effortlessly repels the build up of grime, limescale and stains. All of Roman's exclusive ranges are supplied with a pre-coating of Roman Ultra Care as standard - aiding glass protection from day one.

AWARDS:

We are proud to announce that we have been awarded the Queen's Award for Enterprise for International Trade. Roman has also been identified as one of London Stock Exchange's 1000 Companies to Inspire Britain. We are extremely proud to be recognised as one of the UK's fastest growing and most dynamic small and medium sized businesses. Roman is included in the FT1000, which is the list of Europe's Fastest Growing Companies, compiled by the Financial Times. We have also been awarded the Bathroom Safety Compliance Award 2018 by the NHIC.

All Haven products are designed by Roman's in-house team of Designers to offer a diverse range of contemporary products, at an affordable price. The Haven Plus collection encompasses an array of quadrant, bi-fold, pivot, sliding and corner entry enclosures, a selection of side panels and in-line panels, stylish bath screens, wetroom panels and shower trays. Haven enclosures and bath screens feature toughened safety glass and bright silver framing, which effortlessly and seamlessly complement all bathroom shapes and styles.



Roman have an ongoing policy of design, development and improvement and thus reserve the right to modify specification, ranges and prices without prior notice. Images are for illustration purposes only - please refer to your retailer as site conditions will vary or contact Roman Customer Relations on 01325 328033 for installation specifications.

	Page
Introduction	2 - 3
One Door Quadrant	4 - 5
Two Door Quadrant	6 - 7
Bi-Fold Door	8 - 9
Pivot Door	10 - 11
Sliding Door	12 - 13
Level Access Sliding Door	14 - 15
Corner Entry	16 - 17
Side and In-Line Panels	18 - 19
Wetroom Panels	20 - 23
Bath Screens	24 - 25
Roman Acrylic Shower Trays	26
Roman Anti-Slip Trays	27
Roman Infinity Trays	28 - 29
Product After Care	30
Guarantee Information	31

Protecting the Environment

For our full Environmental policy please visit www.roman-showers.com



All waste is segregated into recyclables and non-recyclables. 93% of all waste is recycled - landfill waste is reduced to 7% of total waste generated.



All Roman Shower Enclosures and Bath Screens and Trays are manufactured in the UK.



All Roman Shower Enclosures, Bath Screens and Trays are manufactured in the UK.

All vehicles with Euro 5 compliance engine vehicles saving 22% on emissions.

Company car policy has been updated so only vehicles with less than 125 grams of CO₂'s per Kilometre can be used in the fleet.

Overall company CO₂ reduction since 2009 is 20%.

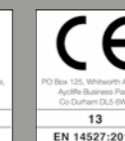

All Roman products fully conform to and exceed the European standards and carry the CE Marking.



EMS 523823



FS 523822



Roman brochures are printed on stock sourced from responsible forests.

One Door Quadrant



1200 x 900mm Quadrant - H3SQ129CS | Roman Acrylic Tray - RLQ129R

GLASS HEIGHT 1900 mm

GLASS THICKNESS 6 mm

The polished sliding door design of the One Door Quadrant presents a stylish and perfect space saving solution for the bathroom. The smooth gliding door allows for existing bathroom furniture, whilst also providing a luxuriously large showering area. The Quadrant features 'quick release bearings' to enable easy cleaning of the enclosure. It is available in five different size configurations including offset versions for bathrooms that have more space on one wall and less on another. The various size options allow the Quadrant to be used in different bathroom layouts and sizes.

SPECIFICATIONS:

- **Tray Compatibility:** 550mm radius
- Smooth running bearing assemblies in the top and bottom rails
- 'Quick release bearings' in the bottom rail
- Full length colourless PVC seals
- Chromed brass handle on inside and outside of enclosure
- Chromed plastic top caps
- Easy Installation
- Reversible for left or right hand fixing



900 x 900mm Quadrant - H3SQ9CS | Roman Acrylic Tray - RLQ90

Code	Description	Size (mm)	Aperture (mm)	Adjustment (mm)
H3SQ9CS	One Door Quadrant	900 x 900	450	865 - 890
H3SQ98CS*	One Door Quadrant	900 x 800	450	865 - 890 & 765 - 790
H3SQ810CS*	One Door Offset Quadrant	1000 x 800	450	765 - 790 & 965 - 990
H3SQ812CS*	One Door Offset Quadrant	1200 x 800	450	765 - 790 & 1165 - 1190
H3SQ129CS*	One Door Offset Quadrant	1200 x 900	450	1165 - 1190 & 865 - 890

*Must specify handing of tray - for full list of tray sizes and options see pages 26 - 29

N.B. The smaller panel will always be on the short side of the tray

Two Door Quadrant



900 x 900mm Two Door Quadrant - H3Q9CS | Roman Acrylic Tray - RLQ90

GLASS HEIGHT 1900 mm

GLASS THICKNESS 6 mm

Elegant minimalism meets curvaceous lines to create a modern stylish showering solution. This Quadrant is a perfect configuration for when space is at a premium. The two sliding doors are a clever space-saving tactic, whilst offering an indulgent showering area. It is available in six sizes to suit any showering space, and the 'quick release' mechanism makes for easy cleaning. In addition, it is also available in an offset version, which is ideal for a bathroom that has more space to spare on one wall and less on another

SPECIFICATIONS:

- **Tray Compatibility:** 550mm radius
- Smooth running bearing assemblies in the top and bottom rails
- 'Quick release bearings' in the bottom rail
- Full length colourless PVC and magnetic seals
- Chromed brass handles on inside and outside of enclosure
- Chromed plastic top caps
- Easy Installation
- Reversible for left or right hand fixing



1200 x 900mm Two Door Offset Quadrant - H3Q129CSR | Roman Acrylic Tray - RLQ129R

Code	Description	Size (mm)	Aperture (mm)	Adjustment (mm)
H3Q8CS	Two Door Quadrant	800 x 800	380	765 - 790
H3Q9CS	Two Door Quadrant	900 x 900	510	865 - 890
H3Q98CS*	Two Door Offset Quadrant	900 x 800	450	865 - 890 & 765 - 790
H3Q810CS*	Two Door Offset Quadrant	1000 x 800	450	765 - 790 & 965 - 990
H3Q812CS*	Two Door Offset Quadrant	1200 x 800	450	765 - 790 & 1165 - 1190
H3Q129CS*	Two Door Offset Quadrant	1200 x 900	520	1165 - 1190 & 865 - 890

*Must specify handing of tray - for full list of tray sizes and options see pages 26 - 29

Bi-Fold Door



800mm Bi-Fold Door - H3B8CS | Roman Acrylic Tray - RLT80

GLASS HEIGHT 1900 mm

GLASS THICKNESS 4 mm

The in-fold design of the inward opening Haven Plus Bi-Fold Door makes clever use of available space with minimum bathroom intrusion. The precision crafted door glides and hinges ensure the toughened glass effortlessly folds back into the shower surround, whilst the sleek chrome frame maintains a sturdy and secure unit. It is available with a frameless side panel for corner installation.

SPECIFICATIONS:

- Chromed plastic top caps
- Smooth running bearing assemblies running in the top and bottom rail
- Easy Installation
- Reversible for left or right hand fixing



800mm Bi-Fold Door - H3B8CS | 300mm In-line Panel - H3HL3CS
800mm Side Panel - H3R8CS | Roman Acrylic Tray - RLT118

Code	Size (mm)	Aperture (mm)	Adjustment (mm) Alcove Fitting	Adjustment (mm) With Side Panel
H3B76CS	760	435	700 - 750	730 - 780
H3B8CS	800	475	740 - 790	770 - 820
H3B9CS	900	575	840 - 890	870 - 920
H3B10CS	1000	675	940 - 990	970 - 1020

For full list of tray sizes and options see pages 26 - 29

For Side Panel and In-Line Panel information see page 18 - 19

Pivot Door

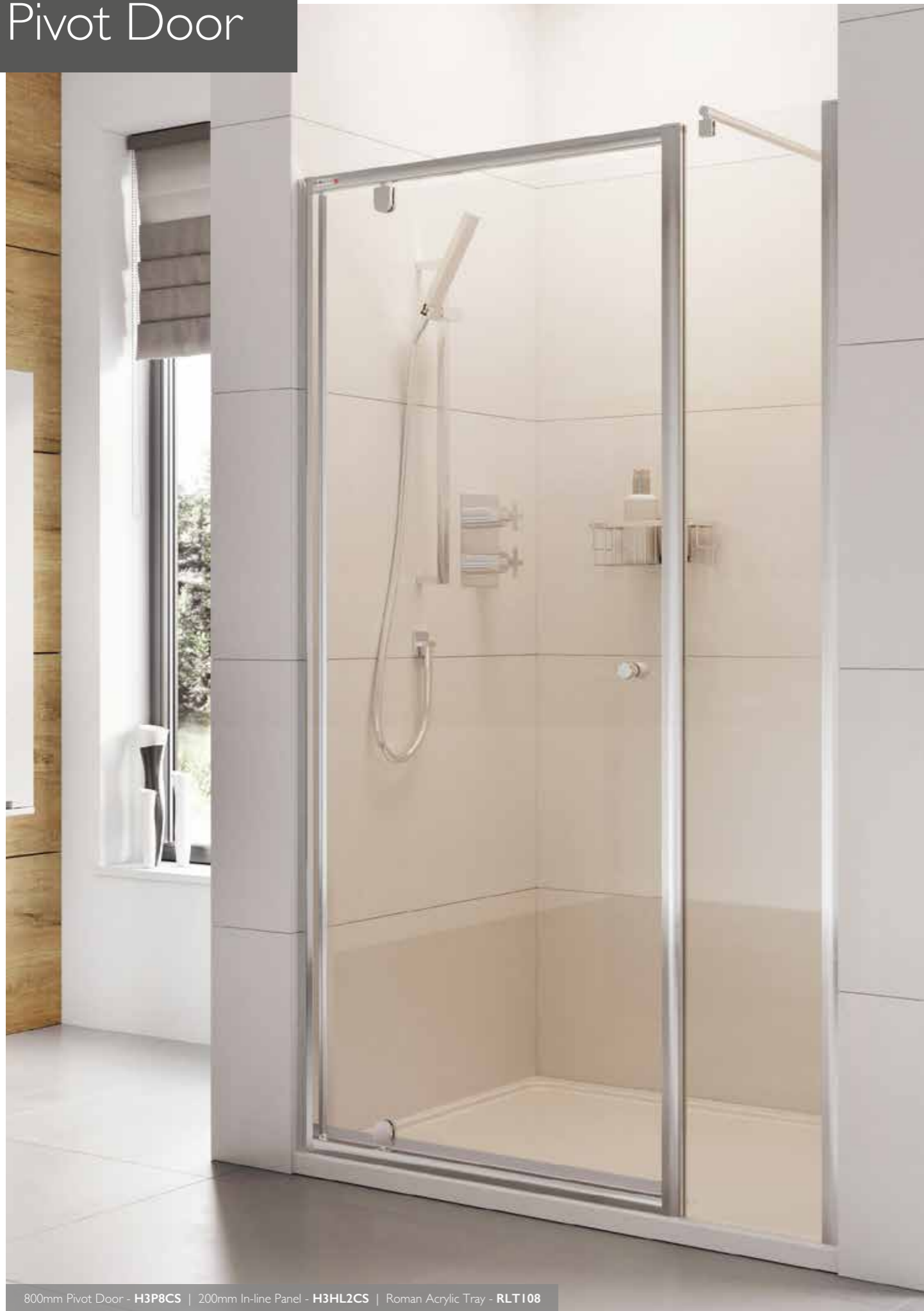

800mm Pivot Door - H3P8CS | 200mm In-line Panel - H3HL2CS | Roman Acrylic Tray - RLT108

GLASS HEIGHT 1900 mm

GLASS THICKNESS 6 mm

The modern styling of this outward opening Pivot Door creates a supremely efficient and flexible solution to suit any number of showering configurations. The carefully engineered door cleverly takes up less external space when opened to allow for other bathroom fixtures and fittings. The Haven Pivot Door can be installed in a recess, or combined with Haven In-Line Panels and Side Panels to create a personalised and striking showering space.

SPECIFICATIONS:

- Watertight magnetic seals
- Chromed brass bolt through handle
- Chromed plastic top caps
- Smooth operation hinges with chromed plastic cover caps
- Reversible for left or right hand fixing



800mm Pivot Door - H3P8CS | 800mm Side Panel - H3R8CS | Roman Acrylic Tray - RLT80

Code	Size (mm)	Aperture (mm)	Adjustment (mm) Alcove Fitting	Adjustment (mm) With Side Panel
H3P7CS	700	400	640 - 690	666 - 716
H3P76CS	760	460	700 - 750	726 - 776
H3P8CS	800	500	740 - 790	766 - 816
H3P9CS	900	600	840 - 890	866 - 916

For full list of tray sizes and options see pages 26 - 29

For Side Panel and In-Line Panel information see page 18 - 19

Sliding Door



1200mm Sliding Door - **H3S12CS** | Matt Grey Anti-Slip Tray - **RSTI28MG** | Plinth and Leg Set - **RSTRK02**

GLASS
HEIGHT 1900 mm

GLASS
THICKNESS 6 mm

The stylish sliding doors glide effortlessly on the single unobtrusive top rail and the 'quick release' mechanism featured on the bottom rail makes cleaning a simple task. It is an ideal solution when space is at a premium as the sliding doors do not project out into the bathroom. It can be combined with a Haven Plus Side Panel to create a larger showering area to suit all your showering needs.

SPECIFICATIONS:

- PVC / magnetic seals
- Chromed brass bolt through handle
- Chromed plastic top caps
- Smooth running bearing assemblies in the top and bottom rails
- 'Quick release bearings' in the bottom rail
- Reversible for left or right hand fixing



1700mm Sliding Door - **H3S17CS** | 800mm Side Panel - **H3R8CS** | Gloss White Infinity Tray - **IAG178**

Code	Size (mm)	Aperture (mm)	Adjustment (mm) Alcove Fitting	Adjustment (mm) With Side Panel
H3S10CS	1000	390	940 - 990	966 - 1016
H3S11CS	1100	440	1040 - 1090	1066 - 1116
H3S12CS	1200	490	1140 - 1190	1166 - 1216
H3S13CS	1300	540	1240 - 1290	1266 - 1316
H3S14CS	1400	590	1340 - 1390	1366 - 1416
H3S15CS	1500	640	1440 - 1490	1466 - 1516
H3S16CS	1600	690	1540 - 1590	1566 - 1616
H3S17CS	1700	740	1640 - 1690	1666 - 1716

For full list of tray sizes and options see pages 26 - 29

For Side Panel and In-Line Panel information see page 18 - 19

Level Access Sliding Door



1700mm Level Access Sliding Door - **H3LEL17CS** (Left Hand) | Black Infinity Shimmer Tray - **IAG178B**

GLASS HEIGHT 1900 mm

GLASS THICKNESS 6 mm

This innovative enclosure is ideal for the whole family with its barrier free bottom rail option, spacious door opening and stylish ergonomic handle. Its design is truly inclusive, whilst maintaining its luxury styling and superb water integrity. The sliding door allows for existing bathroom furniture, making it ideal for small or large bathroom spaces.

SPECIFICATIONS:

- Easy release door function
- Chromed brass bolt through handle
- Chromed plastic top caps
- Smooth running bearing assemblies in the top rails
- Optional aluminium water guard strip (supplied)
- Right or left handing must be specified



1700mm Level Access Sliding Door - **H3LEL17CS** (Left Hand)
800mm Side Panel - **H3R8CS** | Grey Infinity Shimmer Tray - **IAG178G**

Code	Size (mm)	Handing	Aperture (mm)	Adjustment (mm) Alcove Fitting	Adjustment (mm) With Side Panel
H3LEL10CS	1000	Left Hand	390	940 - 990	976 - 1017
H3LER10CS	1000	Right Hand	390	940 - 990	976 - 1017
H3LEL11CS	1100	Left Hand	440	1040 - 1090	1076 - 1117
H3LER11CS	1100	Right Hand	440	1040 - 1090	1076 - 1117
H3LEL12CS	1200	Left Hand	490	1140 - 1190	1176 - 1217
H3LER12CS	1200	Right Hand	490	1140 - 1190	1176 - 1217
H3LEL14CS	1400	Left Hand	590	1340 - 1390	1376 - 1417
H3LER14CS	1400	Right Hand	590	1340 - 1390	1376 - 1417
H3LEL17CS	1700	Left Hand	740	1640 - 1690	1676 - 1717
H3LER17CS	1700	Right Hand	740	1640 - 1690	1676 - 1717

For full list of tray sizes and options see pages 26 - 29

For Side Panel and In-Line Panel information see page 18 - 19

Corner Entry



1200 x 800mm Corner Entry - H3C812CS | Roman Acrylic Tray - RLT128

GLASS HEIGHT 1900 mm

GLASS THICKNESS 6 mm

The Corner Entry enclosure is an ideal showering solution for when entry through the diagonal is more practical, but without the compromise on showering space. The 'quick release' system on the bottom of each door allows quick and unobstructed cleaning. The Corner Entry is available in a range of sizing options, including offset versions.

SPECIFICATIONS:

- PVC / magnetic seals
- Chromed brass bolt through handles
- Chromed plastic top caps
- Smooth running bearing assemblies in the top and bottom rails
- 'Quick release bearings' in the bottom rail
- Reversible for left or right hand fixing



760mm Corner Entry - H3C76CS | Roman Acrylic Tray - RLT76

Code	Size (mm)	Aperture (mm)	Adjustment (mm)
H3C7CS	700 x 700	330	665 - 690
H3C76CS	760 x 760	375	725 - 750
H3C769CS	760 x 900	425	725 - 750 & 865 - 890
H3C7610CS	760 x 1000	460	725 - 750 & 965 - 990
H3C8CS	800 x 800	400	765 - 790
H3C9CS	900 x 900	470	865 - 890
H3C10CS	1000 x 1000	545	965 - 990
H3C79CS	700 x 900	400	665 - 690 & 865 - 890
H3C89CS	800 x 900	435	765 - 790 & 865 - 890
H3C812CS	800 x 1200	545	765 - 790 & 1165 - 1190

For full list of tray sizes and options see pages 26 - 29

For Side Panel and In-Line Panel information see page 18 - 19

Side and In-Line Panels and Extension Profiles



300mm In-line Panel - H3HL3CS | 700mm Side Panel - H3R7CS

GLASS HEIGHT 1900 mm

GLASS THICKNESS 6 mm

The Haven Plus Side Panels and In-Line Panels are compatible with the Haven Bi-Fold, Pivot and Sliding Doors. The Extension Profile extends all doors, side panels and in-line panels.

SPECIFICATIONS:

- Chromed plastic top caps
- Reversible for left or right hand fixing



800mm Side Panel - H3R8CS



Pivot door & side panel close up



Bi-fold door, in-line & side panel close up

Code	Description	Size (mm)	Adjustment (mm)
H3R7CS	Side Panel	700 x 1900	665 - 690
H3R76CS	Side Panel	760 x 1900	725 - 750
H3R8CS	Side Panel	800 x 1900	765 - 790
H3R9CS	Side Panel	900 x 1900	865 - 890
H3R10CS	Side Panel	1000 x 1900	965 - 990
H3HL2CS	In-Line Panel	200 x 1900	+200 to door size
H3HL3CS	In-Line Panel	300 x 1900	+300 to door size
H3ZEXS	Extension Profile	-	40mm extra

8mm Wetroom Panels



900mm Wetroom Panel - H3SP9CS | 400mm Pivoting 'L' Panel - H3SPM4CS

GLASS HEIGHT 2000 mm

GLASS THICKNESS 8 mm

To create a minimalist contemporary wetroom, there are various unique designs to suit everyone's needs. For a complete minimalist option there is the stunning corner panel, which can be installed to a shower tray, or straight to the floor for ease of access. A stylish addition to the wetroom can be an end panel which provides a more enclosed showering space.

Additional support can be offered with an optional bracing bar which can be cut to the required length and a return panel can also be added to the design to guide the water back into the showering area. An adjustable foot is also included for supporting the fixed 'L' return panel on a standard tray if required and an inward pivoting 'L' return panel is now available.

SPECIFICATIONS:

- Reversible for left or right hand applications
- Suitable for use with power showers
- A stylish low level brace bar can be purchased separately if required



900mm Wetroom Panel - H3SP9CS | 800mm Wetroom Panel - H3SP8CS
400mm Pivoting 'L' Panel - H3SPM4CS | Brace Bar - HBBK4590

Code	Description	Actual Size (mm)
H3SP7CS	700 Wetroom Panel	657 - 672
H3SP8CS	800 Wetroom Panel	757 - 772
H3SP9CS	900 Wetroom Panel	857 - 872
H3SP10CS	1000 Wetroom Panel	957 - 972
H3SP12CS	1200 Wetroom Panel	1157 - 1172
H3SPL2CS	200 'L' Shaped Fixed Return Panel	226
H3SPM2CS	200 'L' Shaped Pivoting Return Panel	243
H3SPM3CS	300 'L' Shaped Pivoting Return Panel	343
H3SPM4CS	400 'L' Shaped Pivoting Return Panel	443
HBBK4590*	Optional Brace Bar	1000 - Cut to fit

*Minimum clearance from top of glass to ceiling for fixing the brace bar is 35mm.

Due to the nature of the product water integrity cannot be guaranteed - please consult your installer.

See pages 22 - 23 for more illustrations



900mm Wetroom Panel - **H3SP9CS** | 800mm Wetroom Panel - **H3SP8CS** | Brace Bar - **HBBK4590**



1000mm Wetroom Panel - **H3SP10CS** | Brace Bar - **HBBK4590**

PIVOTING 'L' RETURN PANEL



FIXED 'L' RETURN PANEL



900mm Panel - **H3SP9CS** | 200mm 'L' Panel - **H3SPL2CS** | 800mm Panel - **H3SP8CS**

BRACE BARS



Brace bar back to wall or can be cut to fit at 45° angle
HBBK4590



ADJUSTABLE FOOT (OPTIONAL)



Supplied with **H3SPL2CS**

Bath Screens

ANGLED BATH SCREEN



SPECIFICATIONS:

- **Width:** 850mm
- Bright silver aluminium towel rail
- Frameless with radius glass
- Reversible for left or right hand fixing
- Suitable for all standard bath mixer and electric showers
- Not recommended for use with pumped or pressurised systems

There are four stylish bath screens available in the Haven range - each offering a perfect and unique over the bath showering solution. The Angled Bath Screen comes complete with an integrated towel rail for the ultimate style statement, and features a rising hinge system which enables the screen to be raised slightly during cleaning and to be lowered during use for a stronger seal mechanism. The Curved Bath Screen offers a new take on the contemporary bath screen; its curvaceous lines create both a practical and stylish screen.

The Standard Bath Screen presents clean and uncomplicated lines, offering a sleek and stylish over the bath showering solution. The Inward Folding Bath Screen cleverly folds away when not in use to allow full access to the bath, and is power shower approved.

CURVED BATH SCREEN



SPECIFICATIONS:

- **Width:** 820mm
- Rotates through 180° for access
- Frameless with radius glass
- Reversible for left or right hand fixing
- Suitable for all standard bath mixer and electric showers
- Not recommended for use with pumped or pressurised systems

STANDARD BATH SCREEN



SPECIFICATIONS:

- **Width:** 820mm
- Rotates through 180° for access
- Frameless with square glass
- Reversible for left or right hand fixing
- Suitable for all standard bath mixer and electric showers
- Not recommended for use with pumped or pressurised systems

INWARD FOLDING BATH SCREEN



SPECIFICATIONS:

- **Width Open:** 525 - 550mm / **Width Closed:** 885 - 910mm
- Frameless with radius glass
- Reversible for left or right hand fixing
- **Suitable for use with power showers**
- Optional brace bar included

Code	Description	Size (mm)	Adjustment (mm)
H2D1CS	Angled Bath Screen	1500 x 850	850 - 875
H2D2CS	Curved Bath Screen	1360 x 820	810 - 825
H2D3CS	Standard Bath Screen	1360 x 820	810 - 825
H2D6CS	Inward Folding Bath Screen	1500 x 910	885 - 910

Acrylic Capped Stone Trays

In its diverse range of footprints and gloss finish, the Roman Tray range perfectly complements our diverse range of shower enclosures to deliver something truly stunning and unique for every installation. The power shower approved, easy clean, 90mm rapid drain outlet works with the sleek lines of the tray, allowing up to 36 litres of water to be carried away per minute. Incorporating a 40mm profile, the Roman Tray when installed offers a small step into the shower enclosure. Manufactured from composite resin capped acrylic it is easy to install as it offers the option of flat to floor or raised on legs installation.



SPECIFICATIONS:

- Low profile - only 40mm in height
- Available with optional leg kits to create raised version
- Manufactured from a composite resin capped acrylic
- Gloss finish
- Height of panel kits 95mm
- 90mm Domed Waste included

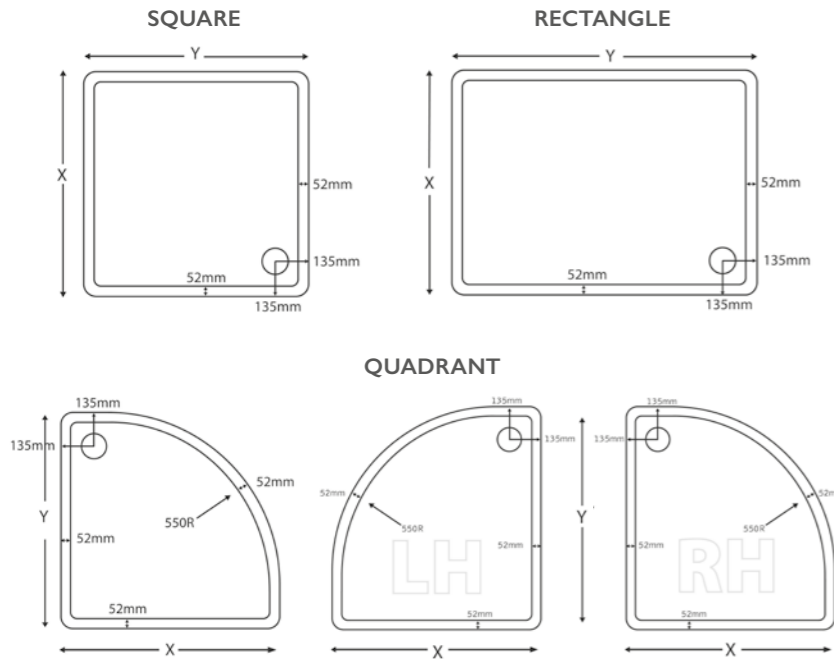

RISER PANEL KIT

Shown with legs and front panel



Code Size OPTIONAL Riser & Panel Kit

Code	X (mm)	Y (mm)	OPTIONAL Riser & Panel Kit
SQUARE TRAY			
RLT76	760	x 760	RTPK03
RLT80	800	x 800	RTPK03
RLT90	900	x 900	RTPK03
RLT100	1000	x 1000	RTPK04
RECTANGLE TRAY			
RLT79	900	x 760	RTPK03
RLT107	1000	x 760	RTPK03
RLT108	1000	x 800	RTPK03
RLT109	1000	x 900	RTPK03
RLT118	1100	x 800	RTPK03
RLT119	1100	x 900	RTPK03
RLT127	1200	x 760	RTPK03
RLT128	1200	x 800	RTPK03
RLT129	1200	x 900	RTPK03
RLT149	1400	x 900	RTPK04
RLT158	1500	x 800	RTPK04
RLT168	1600	x 800	RTPK04
RLT178	1700	x 800	RTPK04
RLT188	1800	x 800	RTPK04
QUAD TRAY			
RLQ80	800	x 800	RTPK01
RLQ89L*	900	x 800 - LH	RTPK01
RLQ89R*	900	x 800 - RH	RTPK01
RLQ90	900	x 900	RTPK01
RLQ108L*	1000	x 800 - LH	RTPK02
RLQ108R*	1000	x 800 - RH	RTPK02
RLQ128L*	1200	x 800 - LH	RTPK02
RLQ128R*	1200	x 800 - RH	RTPK02
RLQ129L*	1200	x 900 - LH	RTPK02
RLQ129R*	1200	x 900 - RH	RTPK02

RISER KITS & WASTE

RTPK03	1200 Square / Rectangle Panel Kit + feet
RTPK04	1800 Rectangle Panel Kit + feet
RTPK01	Quadrant Panel Kit + feet
RTPK02	Off Set Quadrant Panel Kit + feet
RTW	Roman Tray Waste (90mm)

*Left or right handing must be specified

Size (mm)	Finish	White Code	Grey Code
1000 x 800	Matt	RST108	RST108MG
1200 x 800	Matt	RST128	RST128MG
1200 x 900	Matt	RST129	RST129MG
1300 x 800	Matt	RST138	RST138MG
1400 x 900	Matt	RST149	RST149MG
1500 x 800	Matt	RST158	RST158MG
1600 x 700	Matt	RST167	RST167MG
1600 x 800	Matt	RST168	RST168MG
1700 x 800	Matt	RST178	RST178MG

PLINTH AND LEG SET

Standard Riser Kit	Matt	RSTRK01	RSTRK02
--------------------	------	---------	---------

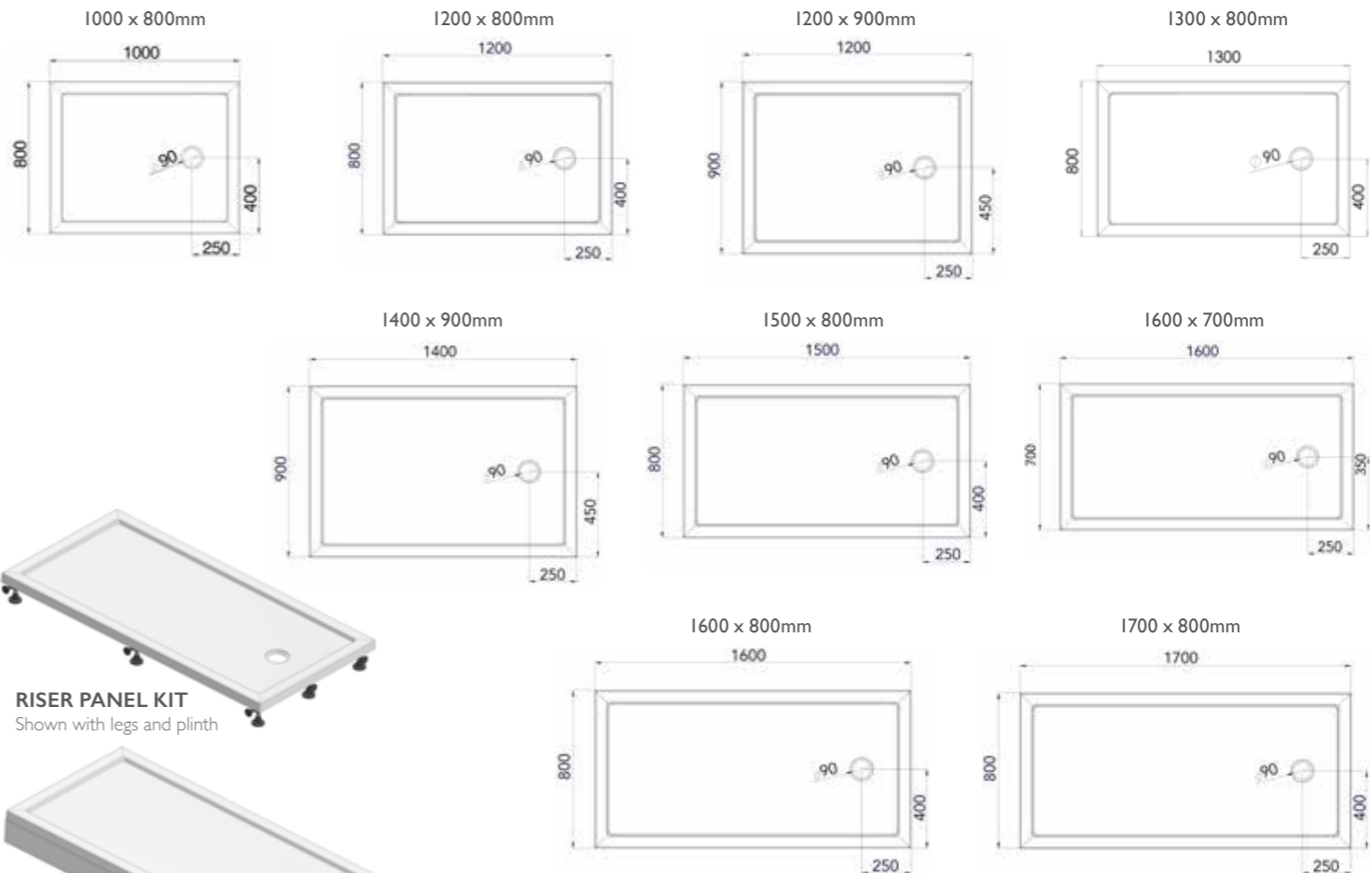

RISER PANEL KIT

Shown with legs and plinth

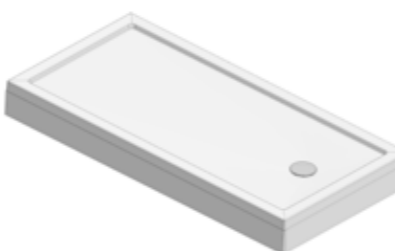

Anti Slip Trays

Matt Trays have been tested to:
BS7976-2:2002+A1:2013 - Slip potential - low DIN 51097:1992 Class C

Anti-Slip Trays



Our collection of Solid Surface Anti Slip Shower Trays offers a stylish finish, with a domed aluminium waste cover. The low profile trays are self-reinforcing so can be laid directly down to joists and then tiled up to, achieving a level access wetroom look. They are available in matt white or grey which has been approved for Anti-Slip properties. For volume orders we can accommodate a variety of colour finishes and sizes to your specification, including stone effect finishes to coordinate your bathroom design.

SPECIFICATIONS:

- Ultra low 50mm profile
- Manufactured using Roman Stone solid surface technology
- One angle of slope to waste to maximise flow rating
- Fast flow waste included
- Solid Surface Plinth and Leg Set available if required
- Chrome plated domed waste

Infinity Trays

Level Access Installation



To create the ultimate modern minimalist look Roman introduce the InfinityTray range which is available in the choice of a matt or gloss finish. Our Infinity Trays offer a breakthrough in technology as they can be installed straight to joists so that once the floor tiles are laid it creates level entry access into the shower area. Manufactured from Roman Stone, the Infinity Trays are strong and durable. They achieve their level access feature due to them being only 40mm nominal height. This product provides the added reassurance of a tray, with the minimalist design and level access of a wetroom. The flawless styling of the Infinity Trays has been designed with a single angle flow to the waste. The waste is suitable for power shower systems and carries away 25 litres of water per minute. This exclusive chic look is completed with a stylish load bearing solid surface waste cover which still allows access to the waste for cleaning.



Shimmer Trays

Exclusive additions to our Infinity Tray collection are original low level shower trays, featuring a stunning shimmer finish. These unique additions include a radiant black, glittering grey and twinkling white shimmer finishes.

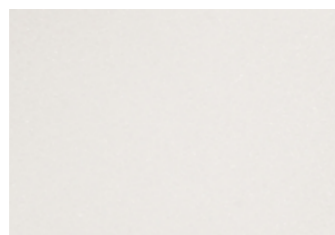

Black Shimmer

White Shimmer



Grey Shimmer

SPECIFICATIONS:

- Ultra low profile
- Gloss or Matt finish
- Manufactured using Roman Stone solid surface technology
- One angle of slope to waste to maximise flow rating
- Fast flow waste included, fully concealed with solid surface cover piece

Size (mm)	Colour	Finish	Code
RECTANGLE			
1000 x 800	White	Matt	IA108*
1000 x 800	White	Gloss	IA108
1000 x 800	Shimmer Black	Gloss	IA108B
1000 x 800	Shimmer White	Gloss	IA108W
1000 x 800	Shimmer Grey	Gloss	IA108G
1200 x 800	White	Matt	IA128*
1200 x 800	White	Gloss	IA128
1200 x 800	Shimmer Black	Gloss	IA128B
1200 x 800	Shimmer White	Gloss	IA128W
1200 x 800	Shimmer Grey	Gloss	IA128G
1200 x 900	White	Matt	IA129*
1200 x 900	White	Gloss	IA129
1200 x 900	Shimmer Black	Gloss	IA129B
1200 x 900	Shimmer White	Gloss	IA129W
1200 x 900	Shimmer Grey	Gloss	IA129G
1400 x 900	White	Matt	IA149*
1400 x 900	White	Gloss	IA149
1400 x 900	Shimmer Black	Gloss	IA149B
1400 x 900	Shimmer White	Gloss	IA149W
1400 x 900	Shimmer Grey	Gloss	IA149G
1600 x 800	White	Matt	IA168*
1600 x 800	White	Gloss	IA168
1600 x 800	Shimmer Black	Gloss	IA168B
1600 x 800	Shimmer White	Gloss	IA168W
1600 x 800	Shimmer Grey	Gloss	IA168G
1700 x 800	White	Matt	IA178*
1700 x 800	White	Gloss	IA178
1700 x 800	Shimmer Black	Gloss	IA178B
1700 x 800	Shimmer White	Gloss	IA178W
1700 x 800	Shimmer Grey	Gloss	IA178G
QUADRANT			
900 x 900	White	Matt	IA9Q*
900 x 900	White	Gloss	IA9Q
900 x 900	Shimmer Black	Gloss	IA9QB
900 x 900	Shimmer White	Gloss	IA9QW
900 x 900	Shimmer Grey	Gloss	IA9QG

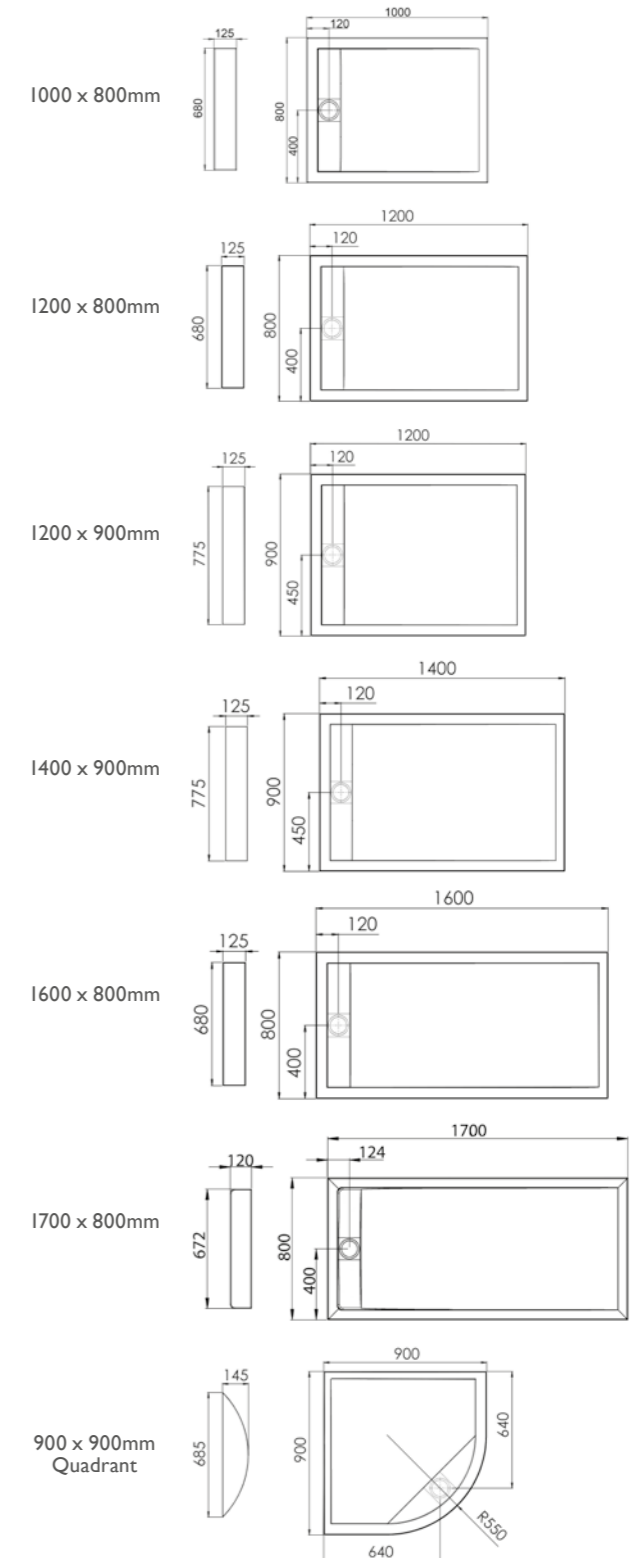

*Anti Slip Trays

Matt Trays have been tested to:
BS7976-2:2002+A1:2013 – Slip potential – low DIN 51097:1992 Class C

The Ultimate Bathroom Protector on glass

All Roman's enclosures and bath screens are pre-coated with Roman Ultra Care, our own unique glass protection system. Pre-coated glass protection systems will always diminish in their effectiveness over time, depending on how often the shower is used and how often it is cleaned. Unlike other systems, Roman Ultra Care in a bottle can be used in tandem with the pre-coat to build up the effectiveness and make it stronger the more you clean.

Roman Ultra Care is an award winning bathroom protector and has a 10 year track record for successfully protecting Roman's extensive product range. When applied to the glass of an enclosure or bath screen it creates a chemical barrier which provides protection against the build-up of grime, limescale and stains. The protective barrier means water glides off the glass with ease. This results in the protected surface remaining easy to clean by simply applying a mild detergent and wiping with a damp cloth or using a Roman Shower Blade.

By topping up the glass protection system with Roman Ultra Care in a bottle every time you clean, you can significantly reduce the amount of time required to clean your enclosure and bathroom surfaces. Most importantly, you can considerably prolong the life of your Roman product and at the same time do your bit for the environment by eliminating the use of harsh and damaging cleaning products.



750ml Bottle Code: RUC03
(minimum quantity for stockists: 12 bottles RUC13)

Ongoing Aftercare

To maintain the long lasting sparkle of your Roman enclosure or bath screen and aid the Ultra Care pre-coated glass protection; Roman Ultra Care can be purchased in a user friendly 750ml sized bottle. This can be purchased from your local Roman Bathroom Retailer, or alternatively from www.romanathome.com (UK only).

Roman Ultra Care is not limited to the cleaning and protection of your shower enclosure or bath screen, it can also be used to protect other bathroom surfaces, which are not pre-coated, including glass, tiles, aluminium frames, taps, trays, sinks and baths.

Simply wipe down your bathroom surfaces after use and apply Roman Ultra Care with a soft cloth. Roman Ultra Care can be used weekly as part of your bathroom cleaning routine.

The more you apply Roman Ultra Care the more protection you create for your enclosure, therefore your enclosure will maintain its high quality finish for longer. Without using Roman Ultra Care, your pre-coated glass protection will diminish over time.

Important information to help you maintain your Roman product:

Ensure you clean your product using a mild detergent diluted in water and then polish off using a soft damp cloth. Apply a coat of Roman Ultra Care after each clean to build-up the protective film on the surface.

If you live in a hard water area, periodically clean your product using a 50/50 solution of white vinegar and water. The solution should be left on the enclosure for approximately 5 minutes then rinsed off using warm water.

1. Do not use acidic based products which are unsuitable for cleaning enamel surfaces.
2. Do not use abrasive cleaners or cleaners containing bleach or solvents, these products will adversely affect the finish of the aluminium profiles.
3. Do not use scouring pads, powder or any sharp instruments when cleaning your Roman enclosure.

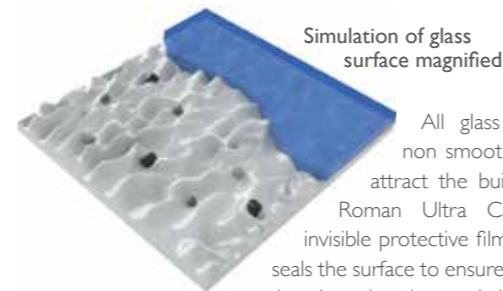

All glass surfaces have a non smooth finish which can attract the build-up of particles. Roman Ultra Care provides an invisible protective film which seamlessly seals the surface to ensure this build-up does not bond to the glass and the glass retains its optical clarity for lasting sparkle.

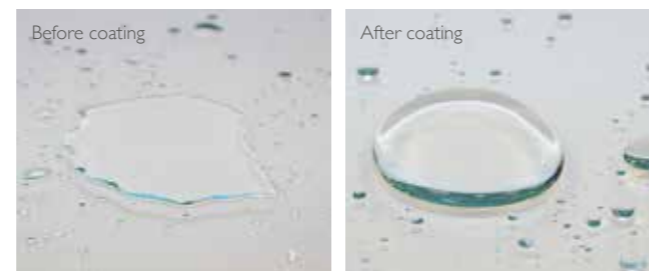

Shower, Tile & Bath Restoration and Maintenance Kit

3 Step System includes:

ULTRA SCRUB - Surface Stain Cleanser

Designed to effectively and easily clean your bathroom surfaces, including Glass, Porcelain, Ceramics and other hard surfaces. Developed to remove the build-up of minerals, rust, soaps, oils and limescale but without damaging the surface.

ULTRA SHIELD - Glass and Surface Treatment

Formulated to clean and protect. Ultra Shield can be used on your bathroom surfaces to create a water, soil and stain repellent barrier coating which prevents water, soil and grime from sticking for easier cleaning. This barrier is renewed with each use.

ULTRA CARE - Glass & Surface Protector

For a long lasting sparkle on bathroom and shower surfaces. Ultra Care is the ultimate surface protector that repels the build-up. Also available in large bottle for ongoing aftercare.

Clean and protect your shower in minutes



Kit Code: RUC14
(minimum quantity for stockists: 12 packs RUC15)

Consumer Guide

Roman shower enclosures have been tested and fully conform to the scope and relevant characteristics of BS EN 14428:2015 (Shower Enclosures - Functional requirements and test methods), to meet the requirements of the mandate given under the EU Construction Product Directive (89/106/EEC).

As a result of full compliance to the directive and harmonized standard; Roman shower enclosures carry the 'CE' mark and are accompanied by a declaration of performance. (Available to view on www.roman-showers.com)

The CE marking indicates Roman shower enclosures conform to all essential requirements of European health and safety and environmental protection legislation. The conformity is mandatory, and allows Roman products to be legally placed on the market anywhere in the European Economic Area.

Additionally all Roman trays fully conform to EN 14527:2016.

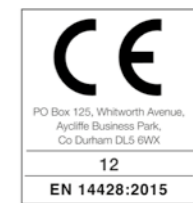

Important Product Details

- Haven Enclosures and Bath Screens carry a ten year manufacturer's guarantee if products are installed according to the installation instructions - see guarantee criteria to the right.
- Simple and clear installation instructions are included with all Haven Products.
- Any guarantee variations are indicated separately.
- All Haven Enclosures and Bath Screens are manufactured using toughened safety glass which complies to BSEN12150.
- All Haven Enclosures and Bath Screens are tested in accordance with BSEN14428 - Shower enclosures, functional requirements and test methods.
- Roman's toughened glass is completely safe for use in our shower enclosures and bath screens; providing our products are installed according to our guidelines.
- It is important to note, that the glass must not be mounted or 'pinched' in such a way that would cause a stress point to develop in the glass. In addition, it must not be subjected to any sharp impact or severe temperature fluctuation which may also cause a stress point to develop in the glass.
- Roman's toughened glass is physically and thermally significantly stronger than standard glass. However a significant impact (or stress as outlined above) can cause toughened glass to break. In the event of breakage, toughened glass will break safely into small fragments in line with all relevant standards.
- All heights quoted for Enclosures and Bath Screens are from the top of the shower tray or bath.
- All fixings are hidden on Haven products.
- The term "Silver" describes the colour of the aluminium finish. No silver metal is included in any Haven products.
- All fixings and pivot pins are manufactured from stainless steel - this adds great strength and durability to Haven products.
- All seals and gaskets on Haven products are manufactured from colourless PVC.
- Haven over-bath products are not designed for baths with shaped or stepped fronts or integral soap dishes.
- The design rights of these products are owned by Roman Limited. All rights reserved.
- For compatibility of Haven Enclosures with steam generators please contact Roman Customer Relations for advice on: +44 (0) 1325 328 033.
- Roman Ultra Care pre-coat must be maintained by applying Ultra Care from a bottle on an ongoing basis as it will naturally diminish over time.
- Due to the nature of the Haven Wetroom Panel products, water integrity cannot be guaranteed. Please consult your installer.

Guarantee

Roman Ltd. guarantees all Haven Shower Enclosures, Bath Screens, Anti-Slip and Infinity Trays against faulty materials or manufacture for ten years, provided they have been installed, used and maintained in accordance with our instructions.

All Roman product guarantees must be completed and returned within 60 days of purchase to validate the relevant guarantee. Failure to meet this deadline will result in a statutory 1 year guarantee on all products.

Should a claim arise Roman Ltd. Customer Relations will investigate the issue. As part of this investigation we request that the following conditions be satisfied:

1. Proof of purchase at the time of the claim.
2. The guarantee applies to the original purchaser only and is non transferable.
3. The product has been fitted / installed in accordance with Haven fixing instructions, local bylaws and general good plumbing practice.
4. The product has been maintained and cared for in accordance with our instructions (including regular and appropriate cleaning).

If in our opinion the product has been modified, misused, neglected, wilfully or accidentally damaged, we can accept no responsibility for failure.

Roman Ltd. or its representatives must be given the opportunity to inspect the product in the installed condition.

Should any products included in the ten year guarantee be used for commercial use i.e. leisure clubs, schools, hospitals, student accommodation, hotels or residential homes, only a 5 year guarantee will be applicable.

If in our opinion the product fails due to faulty materials or manufacture and that the conditions above have been met, Roman Ltd. will arrange for a specialist Roman Technical Sales Representative to repair or replace that item at our option.

Roman Ltd. believes in continuous improvement. If in our opinion the product has failed under the terms of the Guarantee and a replacement is offered but identical goods are no longer available, Roman Ltd will replace it with our nearest equivalent product. For countries outside of the UK and Republic of Ireland, where a product has failed due to faulty materials or manufacture, a replacement product or product part will be offered only.

Should Roman Ltd carry out work as a result of a claim but subsequently it is revealed that the product has been abused or improperly installed, we reserve the right to charge the customer for the expense incurred.

The liability of Roman Ltd. is limited to the product supplied by Roman Ltd. and does not extend to consequential loss or damage arising from the defective product.

This Guarantee, which is effective for products purchased after July 1st 2008, states our entire liability and is offered to customers acquiring our products as consumers, not in the course of trade or business. Ex displays or products reinstalled from their original position are not covered under this guarantee.

Non glass or metallic parts (e.g. seals) are subject to normal wear and tear through usage and are therefore covered on all products for 1 year from installation.

Roman Ultra Care pre-coat is not covered by this guarantee and it must be maintained by applying Ultra Care from a bottle on an ongoing basis.

Haven products not included in the Ten Year Guarantee are the Roman Acrylic Capped Trays which are covered for one year.

This Guarantee does not affect your statutory rights. This Guarantee is wholly applicable in the U.K. and Republic of Ireland – export conditions as indicated.

Roman Limited
Whitworth Avenue, Aycliffe Business Park, County Durham, DL5 6YN
Phone: +44 (0) 1325 328033
www.roman-showers.com

UK:

Roman Limited,
Whitworth Avenue,
Aycliffe Business Park,
County Durham,
DL5 6YN,
England, UK.

GENERAL RECEPTION:

Phone: +44 (0) 1325 311318

UK CUSTOMER RELATIONS:

Phone: +44 (0) 1325 328033
Email: custserv@roman-showers.com

UK SALES:

Phone: +44 (0) 1325 328034
Email: orders@roman-showers.com

INTERNATIONAL SALES/CUSTOMER RELATIONS:

Phone: +44 (0) 1325 327740
Email: international@roman-showers.com
www.roman-showers.com/international

ASIA PACIFIC:

Roman Asia Sdn Bhd ^(091603-K)
No.6, Jalan Olivin, Taman Industri Sungai Purun,
43500 Semenyih, Selangor, Malaysia.

ASIA SALES:

Phone: +60 (0) 3 8723 1211
Email: romanasia@roman-showers.com
www.roman-showers.com/international/roman-asia/

ROMAN IRELAND:

W10F

Ladytown Business Park
Naas
County Kildare
Ireland

IRELAND SALES:

Phone: +353 (0) 45 408 118
Email: irelandsales@roman-showers.com
www.roman-showers.com/international/roman-ireland-information/

www.roman-showers.com

