

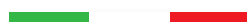

## SHOWER CABINS & STEAM

BATHROOM  
SOLUTIONS

FROM ITALY





## SHOWER CABINS AND STEAM

227	Eon	277	Crystal
241	Glax 3	283	Cristallo 2
249	Media		
255	New Holiday		
265	Nexis		

# RESPECT ENVIRONMENT AND SAFETY



Each of our products has been planned and made to meet the latest European standards regarding quality, safety and respect for environment. The use of production processes with low environmental impact, decreased emission of toxic substances and a considerable reduction in energy consumption are immediate answers to problems of a world in constant evolution.



The range is vast, extremely high quality and probably the most versatile in the market - anything is possible in terms of scale and design. Throughout the world Novellini creates inspiring bathrooms that appeal to individuals at home, via our merchant partners. And, working alongside architects and designers, we create bathroom environments that complement the home, creating a tranquil space promoting Well-being within the living environment.



GOLD AVAILABLE ON SPECIAL REQUEST ONLY

# aluminium



## PVD CHROME FINISH

This surface treatment is exclusive to Novellini, offering a superior bright coating, which is durable and anti-limescale, and truly matches the Chrome finishes found on brassware and shower equipment. Novellini's PVD Chrome surface treatment uses an Environmentally Friendly process that is part of a 100% Zero Emission integrated production cycle.

## ANTIBACTERIAL COATINGS

Silver and Zeolite is added to the PVD Chrome Finish to add antibacterial properties to Novellini's aluminium shower surfaces.

Laboratory tests on Novellini PVD Chrome prove a significant reduction in the proliferation of common bacteria such as Staphylococcus Aureus, MRSA and Escherichia Coli, when compared with traditional aluminium surface treatments.

## CERTIFICATE OF MATERIAL EXCELLENCE

awarded to our chromed profiles



# glass



## TEMPERED GLASS

Glass sheets ranging from 4-8mm thickness are heat treated to create a product that is 3x stronger than untreated glass and that if broken will break in a safe manner.

## CRYSTAL CLEAR TREATMENT

All Novellini clear glass has this non-stick silicone based coating applied to the internal side, this is heat treated to create a full long-lasting chemical bond.

To maintain a limescale and streak-free finish, with anti-bacterial properties, a simple wipe is sufficient; cutting out the need for environmentally harmful harsh chemicals and detergents.

**3 YEAR GUARANTEE**



Designed and manufactured in **ITALY**

# MULTIFUNCTION SHOWER CUBICLES

---

Leave the world outside and find a personal space to relax the mind and body.

## MULTIFUNCTION COMPLETE CUBICLES

---

- 227 **Eon**
- 241 **Glax 3**
- 249 **Media**
- 255 **New holiday**
- 265 **Nexis**
- 277 **Crystal**
- 283 **Cristallo 2**

## TREATMENT

---



**CRYSTAL CLEAR TREATMENT**  
Leaves glass easy to clean.  
Does not support the growth  
of bacteria and scale.  
**Only on clear glass**



**PVD CHROME FINISH**  
Zero emission production  
integrated cycle,  
100% environmentally friendly.  
Antiscale, antibacterial, durable  
and long lasting shine.





# SHOWER CABINS AND STEAM

Exclusive Novellini wellness systems

## ALL FUNCTIONS AND FEATURES AVAILABLE

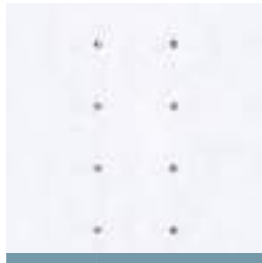

Body hydromassage  
(8 jets)



Dome shower head  
ø 200 mm

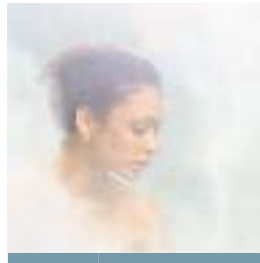

Steam generator



Remote Control

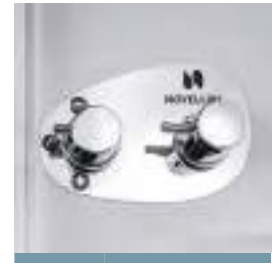

Thermostatic mixer



Hand shower



Led ceiling light



Cromolight  
(hammam only)

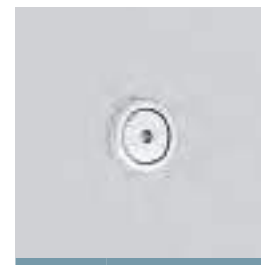

Aux connection  
+ speaker  
(hammam only)



Soap holder

### OPTIONAL



Seat in opal acrylic

**SED030PL**

£ 230

### REQUIRED



**Compulsory**

Imperial to Metric flex  
waste adaptor

**RISCCAB**

£ 10

### PROFILE COLOURS



White



Silver



Chrome

### GLASS TYPES

(European standards UNI EN 14428)

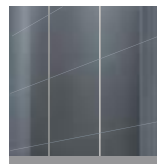

Clear  
6 mm

### INTERNAL PANELS



White gloss



White Matt

### TREATMENT



**CRYSTAL CLEAR TREATMENT**

Leaves glass easy to clean. Does not support the growth of bacteria and scale.  
**Only on clear glass**



**PVD CHROME FINISH**

Zero emission production integrated cycle, 100% environmentally friendly. Antiscale, antibacterial, durable and long lasting shine.

design **Marco Pellici**

All the Hammam models have a sleek frosted glass dome and fixed overhead shower, they also benefit from Aux-in music connection and a waterproof speaker. Operation is via the waterproof remote control. A concealed Steam shower and therapeutic Cromo light, are included as standard, to complete your well-being experience.

EON



# EON 2P 120x90



205 cm



6 mm



p.  
288-289

## MULTIFUNCTION SHOWER CUBICLE - SLIDING DOOR AND SIDE PANEL

Mixer	Dimensions cm	Shower tray cm	Overall height cm	Access cm	Side	Code	Glass	Profile type and price					
								White gloss			White Matt		
							1	AA	AB	AK	UA	UB	UK
							Clear	White	Silver	Chrome	White	Silver	Chrome

C \*

### STANDARD without dome



THERMOSTATIC	120 x 90	H 4,5	209,5	47	D	EON 2P 290 D T-		£ 1.545	£ 1.545	£ 1.615	£ 1.715	£ 1.715	£ 1.785
		S	EON 2P 290 S T-										
		H 11,5	216,5	47	D	EON 2P 299 D T-							
		S	EON 2P 299 S T-										

### STANDARD with dome



THERMOSTATIC	120 x 90	H 4,5	214	47	D	EON 2P 290 D T T-		£ 1.835	£ 1.835	£ 1.905	£ 2.005	£ 2.005	£ 2.075
		S	EON 2P 290 S T T-										
		H 11,5	221	47	D	EON 2P 299 D T T-							
		S	EON 2P 299 S T T-										

### HYDROMASSAGE without dome



THERMOSTATIC	120 x 90	H 4,5	209,5	47	D	EON 2P 290 D T 1-		£ 1.730	£ 1.730	£ 1.800	£ 1.900	£ 1.900	£ 1.970
		S	EON 2P 290 S T 1-										
		H 11,5	216,5	47	D	EON 2P 299 D T 1-							
		S	EON 2P 299 S T 1-										

### HYDROMASSAGE with dome



THERMOSTATIC	120 x 90	H 4,5	214	47	D	EON 2P 290 D T 1 F-		£ 2.055	£ 2.055	£ 2.125	£ 2.225	£ 2.225	£ 2.295
		S	EON 2P 290 S T 1 F-										
		H 11,5	221	47	D	EON 2P 299 D T 1 F-							
		S	EON 2P 299 S T 1 F-										

### HAMMAM (steam shower)



THERMOSTATIC	120 x 90	H 4,5	229,5	47	D	EON 2P 290 D T 1 N-		£ 2.540	£ 2.540	£ 2.610	£ 2.710	£ 2.710	£ 2.780
		S	EON 2P 290 S T 1 N-										
		H 11,5	236,5	47	D	EON 2P 299 D T 1 N-							
		S	EON 2P 299 S T 1 N-										

HOW TO CHOOSE YOUR PRODUCT USING THE CODES:

EON2P290DT-1AA

=

EON2P290DT-

+

1

+

AA

### REQUIRED



#### Compulsory

Imperial to Metric flex  
waste adaptor

#### RISCCAB

£ 10

• IN STOCK UK

(Other products) please check availability



design Marco Pellici

IN THE PHOTO: INSTALLATION RIGHT - HAMMAM MODEL

EON

**S**  
INSTALLATION ON THE LEFT

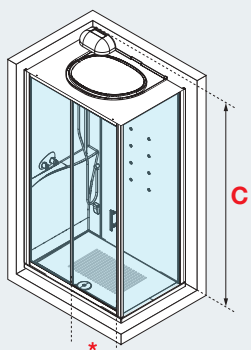

**D**  
INSTALLATION ON THE RIGHT

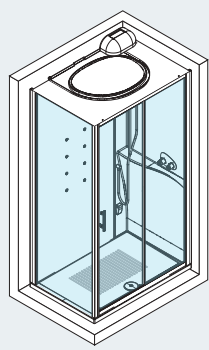

- HYDRAULIC CHARACTERISTICS:**
- 1** Working pressure 2÷5 bar
  - 2** Hot water connection 1/2"  
Cold water connection 1/2"

# EON 2P 120x80



205 cm



6 mm



p.  
288-289

## MULTIFUNCTION SHOWER CUBICLE - SLIDING DOOR AND SIDE PANEL

Mixer	Dimensions cm	Shower tray cm	Overall height cm	Access cm	Side	Code	Glass	Profile type and price					
								White gloss			White Matt		
							1	AA	AB	AK	UA	UB	UK
							Clear	White	Silver	Chrome	White	Silver	Chrome

**C \***



### STANDARD without dome

THERMOSTATIC	120 x 80	H 4,5	209,5	47	D	EON 2P 120 D T-		£ 1.485	£ 1.485	£ 1.555	£ 1.655	£ 1.655	£ 1.725
		S	EON 2P 120 S T-										
		H 11,5	216,5	47	D	EON 2P 129 D T-							
		S	EON 2P 129 S T-										

### STANDARD with dome



THERMOSTATIC	120 x 80	H 4,5	214	47	D	EON 2P 120 D T T-		£ 1.775	£ 1.775	£ 1.845	£ 1.945	£ 1.945	£ 2.015
		S	EON 2P 120 S T T-										
		H 11,5	221	47	D	EON 2P 129 D T T-							
		S	EON 2P 129 S T T-										

### HYDROMASSAGE without dome



THERMOSTATIC	120 x 80	H 4,5	209,5	47	D	EON 2P 120 D T 1-		£ 1.670	£ 1.670	£ 1.740	£ 1.840	£ 1.840	£ 1.910
		S	EON 2P 120 S T 1-										
		H 11,5	216,5	47	D	EON 2P 129 D T 1-							
		S	EON 2P 129 S T 1-										

### HYDROMASSAGE with dome



THERMOSTATIC	120 x 80	H 4,5	214	47	D	EON 2P 120 D T 1 F-		£ 1.995	£ 1.995	£ 2.065	£ 2.165	£ 2.165	£ 2.235
		S	EON 2P 120 S T 1 F-										
		H 11,5	221	47	D	EON 2P 129 D T 1 F-							
		S	EON 2P 129 S T 1 F-										

### HAMMAM (steam shower)



THERMOSTATIC	120 x 80	H 4,5	229,5	47	D	EON 2P 120 D T 1 N-		£ 2.480	£ 2.480	£ 2.550	£ 2.650	£ 2.650	£ 2.720
		S	EON 2P 120 S T 1 N-										
		H 11,5	236,5	47	D	EON 2P 129 D T 1 N-							
		S	EON 2P 129 S T 1 N-										

HOW TO CHOOSE YOUR PRODUCT USING THE CODES:

EON2P120DT-1AA

=

EON2P120DT-

+

1

+

AA

### REQUIRED



#### Compulsory

Imperial to Metric flex  
waste adaptor

#### RISCCAB

£ 10

• IN STOCK UK

(Other products) please check availability



design Marco Pellici

IN THE PHOTO: INSTALLATION RIGHT - HAMMAM MODEL

EON

**S**  
INSTALLATION ON THE LEFT

**D**  
INSTALLATION ON THE RIGHT

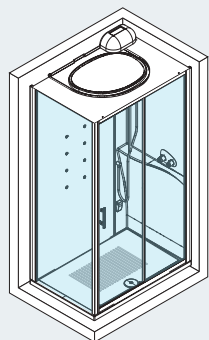
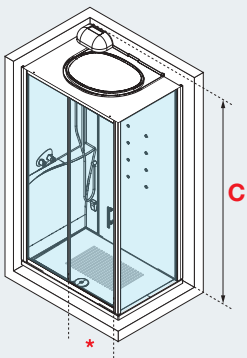

- HYDRAULIC CHARACTERISTICS:**
- 1** Working pressure 2÷5 bar
  - 2** Hot water connection 1/2"  
Cold water connection 1/2"

# EON A 100x80



205 cm



6 mm



p.  
288-289

## MULTIFUNCTIONAL SHOWER CUBICLE: CORNER ENTRY SLIDING DOORS

Mixer	Dimensions cm	Shower tray cm	Overall height cm	Access cm	Side	Code	Glass	Profile type and price					
								White gloss			White Matt		
							1	AA	AB	AK	UA	UB	UK
							Clear	White	Silver	Chrome	White	Silver	Chrome

C \*



### STANDARD without dome

THERMOSTATIC	100 x 80	H 4,5	209,5	45	D	EON A 100 D T-	£ 1.455	£ 1.455	£ 1.520	£ 1.625	£ 1.625	£ 1.690
					D <td>EON A 109 D T-</td> <td></td> <td></td> <td></td> <td></td> <td></td> <td></td>	EON A 109 D T-						
					S <td>EON A 109 S T-</td> <td></td> <td></td> <td></td> <td></td> <td></td> <td></td>	EON A 109 S T-						

### STANDARD with dome

THERMOSTATIC	100 x 80	H 4,5	214	45	D	EON A 100 D T T-	£ 1.745	£ 1.745	£ 1.810	£ 1.915	£ 1.915	£ 1.980
					D <td>EON A 109 D T T-</td> <td></td> <td></td> <td></td> <td></td> <td></td> <td></td>	EON A 109 D T T-						
					S <td>EON A 109 S T T-</td> <td></td> <td></td> <td></td> <td></td> <td></td> <td></td>	EON A 109 S T T-						

### HYDROMASSAGE without dome

THERMOSTATIC	100 x 80	H 4,5	209,5	45	D	EON A 100 D T 1-	£ 1.640	£ 1.640	£ 1.705	£ 1.810	£ 1.810	£ 1.875
					D <td>EON A 109 D T 1-</td> <td></td> <td></td> <td></td> <td></td> <td></td> <td></td>	EON A 109 D T 1-						
					S <td>EON A 109 S T 1-</td> <td></td> <td></td> <td></td> <td></td> <td></td> <td></td>	EON A 109 S T 1-						

### HYDROMASSAGE with dome

THERMOSTATIC	100 x 80	H 4,5	214	45	D	EON A 100 D T 1 F-	£ 1.965	£ 1.965	£ 2.030	£ 2.135	£ 2.135	£ 2.200
					D <td>EON A 109 D T 1 F-</td> <td></td> <td></td> <td></td> <td></td> <td></td> <td></td>	EON A 109 D T 1 F-						
					S <td>EON A 109 S T 1 F-</td> <td></td> <td></td> <td></td> <td></td> <td></td> <td></td>	EON A 109 S T 1 F-						

### HAMMAM (steam shower)

THERMOSTATIC	100 x 80	H 4,5	229,5	45	D	EON A 100 D T 1 N-	£ 2.450	£ 2.450	£ 2.515	£ 2.620	£ 2.620	£ 2.685
					D <td>EON A 109 D T 1 N-</td> <td></td> <td></td> <td></td> <td></td> <td></td> <td></td>	EON A 109 D T 1 N-						
					S <td>EON A 109 S T 1 N-</td> <td></td> <td></td> <td></td> <td></td> <td></td> <td></td>	EON A 109 S T 1 N-						

HOW TO CHOOSE YOUR PRODUCT USING THE CODES:

EONA100DT-1AA

=

EONA100DT-

+

1

+

AA

### REQUIRED



#### Compulsory

Imperial to Metric flex  
waste adaptor

#### RISCCAB

£ 10

Please check availability



design Marco Pellici

IN THE PHOTO: INSTALLATION RIGHT - HAMMAM MODEL

EON

**S**  
INSTALLATION ON THE LEFT

**D**  
INSTALLATION ON THE RIGHT

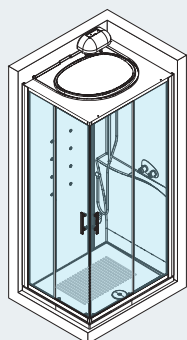
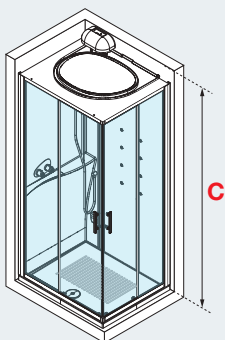

- HYDRAULIC CHARACTERISTICS:**
- 1** Working pressure 2÷5 bar
  - 2** Hot water connection 1/2"
  - Cold water connection 1/2"

# EON R90



205 cm



6 mm



p.  
288-289

## MULTIFUNCTIONAL SHOWER CUBICLE: QUADRANT SLIDING DOORS

Mixer	Dimensions cm	Shower tray cm	Overall height cm	Access cm	Code	Glass	Profile type and price					
							White gloss			White Matt		
						1	AA	AB	AK	UA	UB	UK
						Clear	White	Silver	Chrome	White	Silver	Chrome

C

\*

### STANDARD without dome



THERMOSTATIC	90 x 90	H 4,5	209,5	48	EON R 90 T-		£ 1.595	£ 1.595	£ 1.665	£ 1.765	£ 1.765	£ 1.835
		H 11,5	216,5	48	EON R 99 T-							

### STANDARD with dome



THERMOSTATIC	90 x 90	H 4,5	214	48	EON R 90 T T-		£ 1.885	£ 1.885	£ 1.955	£ 2.055	£ 2.055	£ 2.125
		H 11,5	221	48	EON R 99 T T-							

### HYDROMASSAGE without dome



THERMOSTATIC	90 x 90	H 4,5	209,5	48	EON R 90 T 1-		£ 1.780	£ 1.780	£ 1.850	£ 1.950	£ 1.950	£ 2.020
		H 11,5	216,5	48	EON R 99 T 1-							

### HYDROMASSAGE with dome



THERMOSTATIC	90 x 90	H 4,5	214	48	EON R 90 T 1 F-		£ 2.105	£ 2.105	£ 2.175	£ 2.275	£ 2.275	£ 2.345
		H 11,5	221	48	EON R 99 T 1 F-							

### HAMMAM (steam shower)



THERMOSTATIC	90 x 90	H 4,5	229,5	48	EON R 90 T 1 N-		£ 2.590	£ 2.590	£ 2.660	£ 2.760	£ 2.760	£ 2.830
		H 11,5	236,5	48	EON R 99 T 1 N-							

#### REQUIRED

HOW TO CHOOSE YOUR PRODUCT USING THE CODES:

EONR90T-1AA

=

EONR90T-

+

1

+

AA



#### Compulsory

Imperial to Metric flex  
waste adaptor

#### RISCCAB

£ 10

• IN STOCK UK

(Other products) please check availability



design Marco Pellici

IN THE PHOTO: HAMMAM MODEL

EON

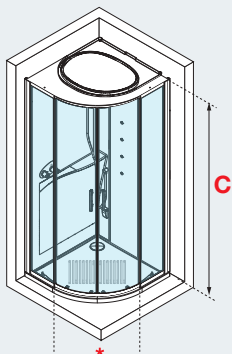

**HYDRAULIC CHARACTERISTICS:**

- Working pressure 2÷5 bar
- Hot water connection 1/2"
- Cold water connection 1/2"



# EON GF90



205 cm



6 mm



p.  
288-289

## MULTI FUNCTION SHOWER CUBICLE: PIVOT DOOR AND SIDE PANEL

Mixer	Dimensions cm	Shower tray cm	Overall height cm	Access cm	Code	Glass	Profile type and price					
							White gloss			White Matt		
							AA	AB	AK	UA	UB	UK
						1	White	Silver	Chrome	White	Silver	Chrome

C

\*

### STANDARD without dome



THERMOSTATIC	90 x 90	H 4,5	209,5	74	EON GF 90 T-		£ 1.470	£ 1.470	£ 1.540	£ 1.640	£ 1.640	£ 1.710
		H 11,5	216,5	74	EON GF 99 T-							

### STANDARD with dome



THERMOSTATIC	90 x 90	H 4,5	214	74	EON GF 90 T T-		£ 1.760	£ 1.760	£ 1.830	£ 1.930	£ 1.930	£ 2.000
		H 11,5	221	74	EON GF 99 T T-							

### HYDROMASSAGE without dome



THERMOSTATIC	90 x 90	H 4,5	209,5	74	EON GF 90 T 1-		£ 1.655	£ 1.655	£ 1.725	£ 1.825	£ 1.825	£ 1.895
		H 11,5	216,5	74	EON GF 99 T 1-							

### HYDROMASSAGE with dome



THERMOSTATIC	90 x 90	H 4,5	214	74	EON GF 90 T 1 F-		£ 1.980	£ 1.980	£ 2.050	£ 2.150	£ 2.150	£ 2.220
		H 11,5	221	74	EON GF 99 T 1 F-							

### HAMMAM (steam shower)



THERMOSTATIC	90 x 90	H 4,5	229,5	74	EON GF 90 T 1 N-		£ 2.465	£ 2.465	£ 2.535	£ 2.635	£ 2.635	£ 2.705
		H 11,5	236,5	74	EON GF 99 T 1 N-							

#### REQUIRED

HOW TO CHOOSE YOUR PRODUCT USING THE CODES:

EONGF90T-1AA

=

EONGF90T-

+

1

+

AA



#### Compulsory

Imperial to Metric flex  
waste adaptor

#### RISCCAB

£ 10

Please check availability



design Marco Pellici

IN THE PHOTO: HAMMAM MODEL

EON

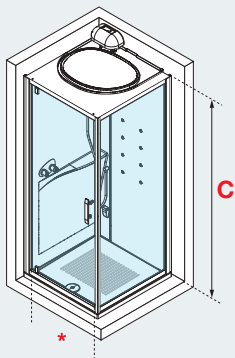

**HYDRAULIC CHARACTERISTICS:**

- Working pressure 2÷5 bar
- Hot water connection 1/2"
- Cold water connection 1/2"

# EON A80 - A90

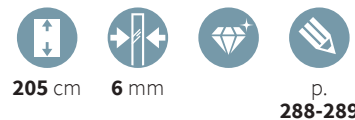

## MULTIFUNCTIONAL SHOWER CUBICLE CORNER ENTRY SLIDING DOORS

Mixer	Dimensions cm	Shower tray cm	Overall height cm	Access cm	Code	Glass	Profile type and price					
							White gloss			White Matt		
						1	AA	AB	AK	UA	UB	UK
						Clear	White	Silver	Chrome	White	Silver	Chrome

C \*

### STANDARD without dome



THERMOSTATIC	90 x 90	H 4,5	209,5	45	EON A 90 T-		£ 1.470	£ 1.470	£ 1.540	£ 1.640	£ 1.640	£ 1.710
		H 11,5	216,5	45	EON A 99 T-		£ 1.285	£ 1.285	£ 1.350	£ 1.455	£ 1.455	£ 1.520
	80 x 80	H 4,5	209,5	38	EON A 80 T-							
		H 11,5	216,5	38	EON A 89 T-							

### STANDARD with dome



THERMOSTATIC	90 x 90	H 4,5	214	45	EON A 90 T T-		£ 1.760	£ 1.760	£ 1.830	£ 1.930	£ 1.930	£ 2.000
		H 11,5	221	45	EON A 99 T T-		£ 1.575	£ 1.575	£ 1.640	£ 1.745	£ 1.745	£ 1.810
	80 x 80	H 4,5	214	38	EON A 80 T T-							
		H 11,5	221	38	EON A 89 T T-							

### HYDROMASSAGE without dome



THERMOSTATIC	90 x 90	H 4,5	209,5	45	EON A 90 T 1-		£ 1.655	£ 1.655	£ 1.725	£ 1.825	£ 1.825	£ 1.895
		H 11,5	216,5	45	EON A 99 T 1-		£ 1.470	£ 1.470	£ 1.535	£ 1.640	£ 1.640	£ 1.705
	80 x 80	H 4,5	209,5	38	EON A 80 T 1-							
		H 11,5	216,5	38	EON A 89 T 1-							

### HYDROMASSAGE with dome



THERMOSTATIC	90 x 90	H 4,5	214	45	EON A 90 T 1 F-		£ 1.980	£ 1.980	£ 2.050	£ 2.150	£ 2.150	£ 2.220
		H 11,5	221	45	EON A 99 T 1 F-		£ 1.795	£ 1.795	£ 1.860	£ 1.965	£ 1.965	£ 2.030
	80 x 80	H 4,5	214	38	EON A 80 T 1 F-							
		H 11,5	221	38	EON A 89 T 1 F-							

### HAMMAM (steam shower)



THERMOSTATIC	90 x 90	H 4,5	229,5	45	EON A 90 T 1 N-		£ 2.465	£ 2.465	£ 2.535	£ 2.635	£ 2.635	£ 2.705
		H 11,5	236,5	45	EON A 99 T 1 N-		£ 2.280	£ 2.280	£ 2.345	£ 2.450	£ 2.450	£ 2.515
	80 x 80	H 4,5	229,5	38	EON A 80 T 1 N-							
		H 11,5	236,5	38	EON A 89 T 1 N-							

HOW TO CHOOSE YOUR PRODUCT USING THE CODES:

EONA90T-1AA

= EONA90T-

+ 1

+ AA

### REQUIRED



#### Compulsory

Imperial to Metric flex waste adaptor

RISCCAB

£ 10

Please check availability



design Marco Pellici

IN THE PHOTO: HAMMAM MODEL

EON

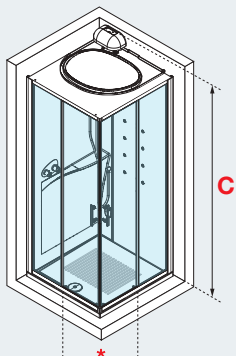

**HYDRAULIC CHARACTERISTICS:**

- Working pressure 2÷5 bar
- Hot water connection 1/2"
- Cold water connection 1/2"

# GLAX 3

Multifunction complete steam cubicle

## ALL FUNCTIONS AND FEATURES AVAILABLE



Body hydromassage



Shower head  
ø 200 mm

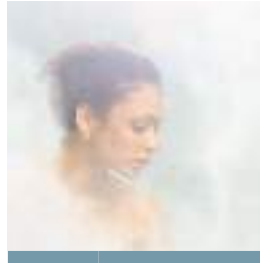

Steam Plus version



Aroma dispenser



Touch Screen Remote Control  
Programmable steam, radio, clock, alarm



Thermostatic mixer



Hand shower



Padded folding seat with SKY covering



Soap holder



Dome



Removable back

## PROFILE COLOURS



Silver



Chrome

## GLASS TYPES (European standards UNI EN 14428)

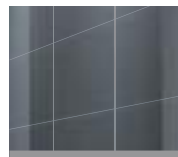

Clear door **6 mm**  
side panel **6 mm**



Back walls glass **5 mm**

## REQUIRED



**Compulsory**  
Imperial to Metric flex waste adaptor

**RISCCAB**

€ 10

## TREATMENT



**CRYSTAL CLEAR TREATMENT**  
Leaves glass easy to clean. Does not support the growth of bacteria and scale. **Only on transparent glass**



**PVD CHROME FINISH**  
Zero emission integrated cycle, 100% environment-friendly. Antiscale, antibacteria, ecological, long-time shining resistance.



GLAX 3

# GLAX 3 GF80 - GF90



p.  
290-291

## PIVOT DOOR + SIDE PANEL

Mixer	Dimensions cm	Shower tray cm	Overall height cm	Access cm	Code	Glass	Profile type / Price	
						1	B	K
			<b>C</b>	<b>*</b>		Clear	Silver	Chrome

## HYDRO without dome



THERMOSTATIC	Dimensions cm	Shower tray cm	Overall height cm	Access cm	Code	Glass	Profile type / Price	
		80 x 80	<b>H 8</b>	206	64		<b>GL3 GF 80 T 1-</b>	
	<b>H 15</b>	213	64	<b>GL3 GF 89 T 1-</b>				
90 x 90	<b>H 8</b>	206	74	<b>GL3 GF 90 T 1-</b>	£ 2.266	£ 2.372		
	<b>H 15</b>	213	74	<b>GL3 GF 99 T 1-</b>				

## HYDRO with dome



THERMOSTATIC	Dimensions cm	Shower tray cm	Overall height cm	Access cm	Code	Glass	Profile type / Price	
		80 x 80	<b>H 8</b>	221	64		<b>GL3 GF 80 T 1 F-</b>	
	<b>H 15</b>	228	64	<b>GL3 GF 89 T 1 F-</b>				
90 x 90	<b>H 8</b>	221	74	<b>GL3 GF 90 T 1 F-</b>	£ 2.581	£ 2.687		
	<b>H 15</b>	228	74	<b>GL3 GF 99 T 1 F-</b>				

## HAMMAM (steam shower)



THERMOSTATIC	Dimensions cm	Shower tray cm	Overall height cm	Access cm	Code	Glass	Profile type / Price	
		80 x 80	<b>H 8</b>	227	64		<b>GL3 GF 80 T 1 N-</b>	
	<b>H 15</b>	234	64	<b>GL3 GF 89 T 1 N-</b>				
90 x 90	<b>H 8</b>	227	74	<b>GL3 GF 90 T 1 N-</b>	£ 3.095	£ 3.201		
	<b>H 15</b>	234	74	<b>GL3 GF 99 T 1 N-</b>				

HOW TO CHOOSE YOUR PRODUCT USING THE CODES:



## REQUIRED



### Compulsory

Imperial to Metric flex  
waste adaptor

**RISCCAB**

£ 10

Please check availability



GLAX 3

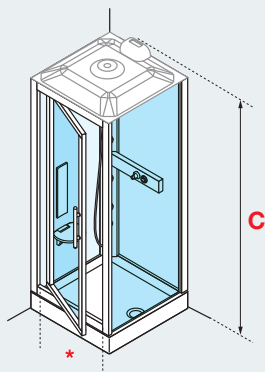

**IMPORTANT:** for the version with low shower tray please see technical drawing at page 482

**OPTIONAL**

**Dome for standard version**

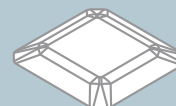

**TGL3STDQ80-A** (80x80)  
**TGL3STDQ90-A** (90x90)  
 £ 262



White led low voltage light  
**WLED CAB**  
 £ 102



Blue led low voltage light  
**BLED CAB**  
 £ 102



# GLAX 3 R90



6 mm



210 cm



p.  
290-291

QUADRANT, 2 SLIDING DOORS + 2 FIXED PANELS

Mixer	Dimensions cm	Shower tray cm	Overall height cm	Access cm	Code	Glass	Profile type / Price	
						1	B	K
			<b>C</b>	<b>*</b>		Clear	Silver	Chrome

## HYDRO without dome



THERMOSTATIC	90 x 90	<b>H 8</b>	206	48	GL3 R 90 T 1-		£ 2.419	£ 2.523
		<b>H 15</b>	213	48	GL3 R 99 T 1-			

## HYDRO with dome



THERMOSTATIC	90 x 90	<b>H 8</b>	221	48	GL3 R 90 T 1 F-		£ 2.734	£ 2.838
		<b>H 15</b>	228	48	GL3 R 99 T 1 F-			

## HAMMAM (steam shower)



THERMOSTATIC	90 x 90	<b>H 8</b>	227	48	GL3 R 90 T 1 N-		£ 3.248	£ 3.352
		<b>H 15</b>	234	48	GL3 R 99 T 1 N-			

HOW TO CHOOSE YOUR PRODUCT USING THE CODES:

GL3R90T1-1B = GL3R90T1- + 1 + B

## REQUIRED



### Compulsory

Imperial to Metric flex  
waste adaptor

**RISCCAB**

£ 10

● IN STOCK UK

(Other products) please check availability



GLAX 3

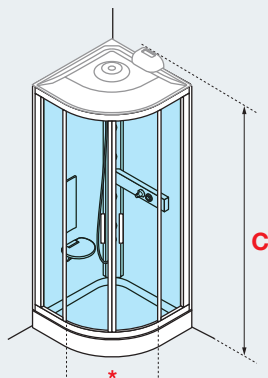

**IMPORTANT:** for the version with low shower tray please see technical drawing at page 482

**OPTIONAL**

**Dome for standard version**



**TGL3STDR90-A**  
£ 262



White led low voltage light  
**WLED CAB**  
£ 102



Blue led low voltage light  
**BLED CAB**  
£ 102

# GLAX 3 2P120x80



door  
8 mm



side panel  
6 mm



210 cm



p.  
290-291

## SLIDING DOOR + SIDE PANEL

Mixer	Dimensions cm	Shower tray cm	Overall height cm	Access cm	Side Lado	Code	Glass	Profile type / Price	
							1	B	K
			<b>C</b>	*			Clear	Silver	Chrome

## HYDRO without dome



THERMOSTATIC	120 x 80	<b>H 8</b>	206	47	<b>D</b>	GL3 2P 120 D T 1-		£ 2.285	£ 2.390
					<b>S</b>	GL3 2P 120 S T 1-			
		<b>H 15</b>	213	47	<b>D</b>	GL3 2P 129 D T 1-		£ 2.285	£ 2.390
					<b>S</b>	GL3 2P 129 S T 1-			

## HYDRO with dome



THERMOSTATIC	120 x 80	<b>H 8</b>	221	47	<b>D</b>	GL3 2P 120 D T 1 F-		£ 2.600	£ 2.705
					<b>S</b>	GL3 2P 120 S T 1 F-			
		<b>H 15</b>	228	47	<b>D</b>	GL3 2P 129 D T 1 F-		£ 2.600	£ 2.705
					<b>S</b>	GL3 2P 129 S T 1 F-			

## HAMMAM (steam shower)



THERMOSTATIC	120 x 80	<b>H 8</b>	227	47	<b>D</b>	GL3 2P 120 D T 1 N-		£ 3.114	£ 3.219
					<b>S</b>	GL3 2P 120 S T 1 N-			
		<b>H 15</b>	234	47	<b>D</b>	GL3 2P 129 D T 1 N-		£ 3.114	£ 3.219
					<b>S</b>	GL3 2P 129 S T 1 N-			

HOW TO CHOOSE YOUR PRODUCT USING THE CODES:

GL32P120DT1-1B = GL32P120DT1- + 1 + B

## REQUIRED



### Compulsory

Imperial to Metric flex  
waste adaptor

RISCCAB

£ 10

• IN STOCK UK

(Other products) please check availability



GLAX 3

PICTURE: LEFT HAND VERSION

**S**  
INSTALLATION ON THE LEFT

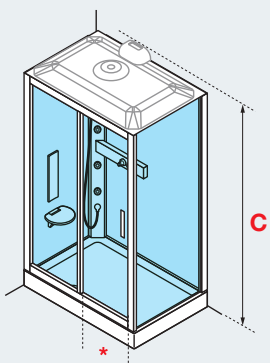

**D**  
INSTALLATION ON THE RIGHT

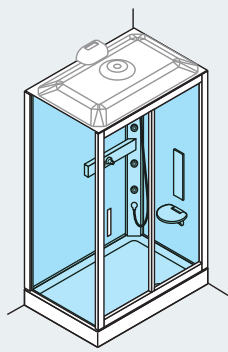

**IMPORTANT:** for the version with low shower tray please see technical drawing at page 482

**OPTIONAL**

**Dome for standard version**

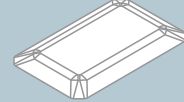

**TGL3STD120D-A** (right)  
**TGL3STD120S-A** (left)  
£ 262



White led low voltage light  
**WLED CAB**  
£ 102



Blue led low voltage light  
**BLED CAB**  
£ 102

# MEDIA

Complete showers are more suited to projects and student accommodation, hotels. They have a flat-pack design with a shower tray and four up-stands, an optional thermostatic shower mixer and slide rail kit.

## AUSSTATTUNGEN DER MODELLE



RückenMeasurementsgedüsen



Thermostatic mixer



Hand shower

## REQUIRED



### Compulsory

Imperial to Metric flex waste adaptor

### RISCCAB

£ 10

## PROFILE COLOURS



White

## GLASS TYPES

(European standards UNI EN 14428)

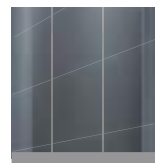

Clear  
3 mm



MEDIA

# MEDIA A80 - A90



201 cm



3 mm



P. 292

CORNER ENTRY



IN THE PHOTO: HYDROMASSAGE VERSION

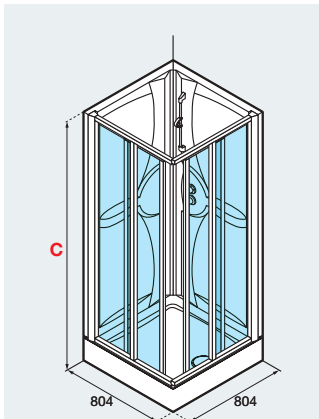

Mixer	Dimensions		Code	Glass	Profile colour
	Measurements cm	Total height cm			
				1	D

C

Clear

White

## STANDARD



THERMOSTATIC	80 x 80	202	MED A 80 T-	●	£ 889
	90 x 90	202	MED A 90 T-	●	£ 1.038

### REQUIRED



**Compulsory**

Imperial to Metric flex waste adaptor

**RISCCAB**

£ 10

How to choose your product using the codes:



● IN STOCK UK  
(Other products) please check availability

# MEDIA R90



201 cm



3 mm



P. 292

## QUADRANT SHOWER



IN THE PHOTO: HYDROMASSAGE VERSION

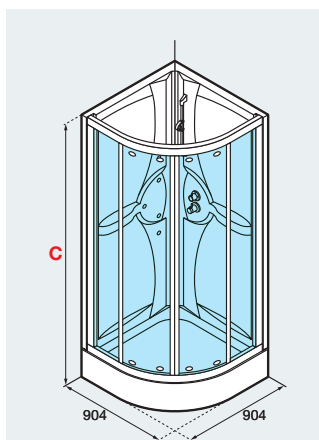

Mixer	Dimensions		Code	Glass	Profile colour Price
	Measurements cm	Total height cm			
		<b>C</b>		<b>1</b> Clear	<b>D</b> White

## STANDARD



THERMOSTATIC	90 x 90	202	<b>MED R 90 T-</b>	<b>•</b>	<b>£ 1.112</b>
--------------	---------	-----	--------------------	----------	----------------

How to choose your product using the codes:

MEDR90T-1D = MEDR90T- + 1 + D

## REQUIRED



### Compulsory

Imperial to Metric  
flex waste adaptor

### RISCCAB

£ 10

• IN STOCK UK

(Other products) please check availability



# MEDIA GF80 - GF90



201 cm



3 mm



P. 292

## PIVOT DOOR



IN THE PHOTO: HYDROMASSAGE VERSION

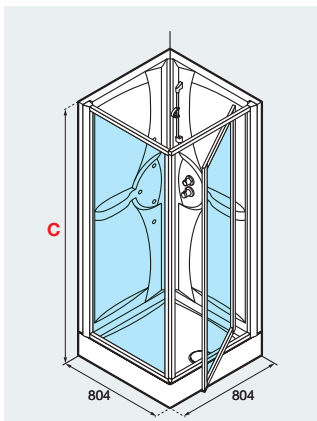

Mixer	Dimensions		Code	Glass	Profile colour
	Measurements cm	Total height cm			
				1	D
				Clear	White

## STANDARD



	Measurements cm	Total height cm	Code	Glass	Price
THERMOSTATIC	80 x 80	202	MED G 80 T-	●	£ 889
	90 x 90	202	MED G 90 T-	●	£ 1.038

How to choose your product using the codes:

MEDG80T-1D = MEDG80T- + 1 + D

## REQUIRED



### Compulsory

Imperial to Metric  
flex waste adaptor

### RISCCAB

£ 10

● IN STOCK UK

(Other products) please check availability



MEDIA

# NEW HOLIDAY

Stylish and contemporary High function Steam shower with Hydrotherapy. A joy to use due to the ergonomic design. Easy to install. Low maintenance due to the sleek white gloss walls and silicone free installation. Fitted with seat for your relaxation.

## ALL FUNCTIONS AND FEATURES AVAILABLE



 Vertical hydromassage (5 adjustable jets)

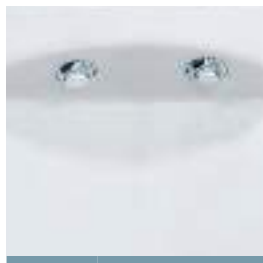

 Neck hydromassage (2 adjustable jets)



 Rotoshower (4 adjustable jets) except mod. R115



 Shower head ø 200 mm



 Cascade only for mod. R115



 Steam generator



 Aroma dispenser



 Touch Screen Remote Control Programmable steam, radio, clock, alarm

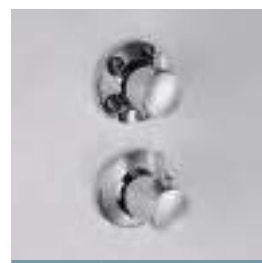

 Thermostatic mixer

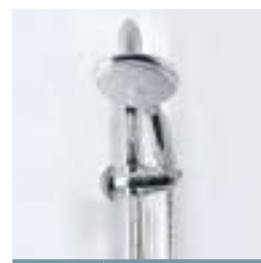

 Hand shower



 Seat



 2 Soap holders



 Dome

## REQUIRED



**Compulsory**  
Imperial to Metric flex waste adaptor

**RISCCAB**  
£ 10

## GLASS TYPES

(European standards UNI EN 14428)

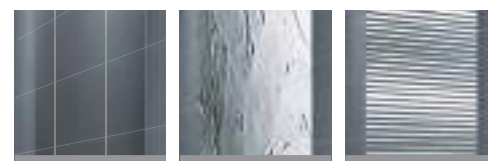

Clear 4 mm      Aqua 4 mm      Esprit printing 4 mm

## PROFILE COLOURS



White      Silver      Chrome

## TREATMENT



**CRYSTAL CLEAR TREATMENT**  
Leaves glass easy to clean. Does not support the growth of bacteria and scale.  
**Only on clear glass**



**PVD CHROME FINISH**  
Zero emission production integrated cycle, 100% environmentally friendly. Antiscale, antibacterial, durable and long lasting shine.



NEW HOLIDAY

**NEW HOLIDAY A80-A90** ▶  
Multifunction complete cubicle

# NEW HOLIDAY R90



200 cm



4 mm



p.  
294-295

## QUADRANT SHOWER

Mixer	Dimensions cm	Total height cm	Access cm	Code	Glass type			Profile colour / Price		
					1	2	5	D	B	K
					Clear	Aqua	Esprit printing	White	Silver	Chrome

## STANDARD without dome



THERMOSTATIC	90 x 90	206	48	<b>NNH R 90 T-</b>				£ 1.412	£ 1.412	£1.483
--------------	---------	-----	----	--------------------	--	--	--	---------	---------	--------

## OPTIONAL DOME FOR STANDARD VERSION

	90 x 90	11	-	<b>TNTR90-A</b>	-	-	-	£ 256	-	-
--	---------	----	---	-----------------	---	---	---	-------	---	---

## HYDROMASSAGE without dome



THERMOSTATIC	90 x 90	206	48	<b>NNH R 90 T 19-</b>				£ 1.595	£ 1.595	£1.675
--------------	---------	-----	----	-----------------------	--	--	--	---------	---------	--------

## OPTIONAL DOME WITH SHOWER HEAD

	90 x 90	11	-	<b>TNTSOFR90-D</b>	-	-	-	£ 296	-	-
--	---------	----	---	--------------------	---	---	---	-------	---	---

## OPTIONAL DOME WITH STEAM GENERATOR AND SHOWER HEAD

	90 x 90	19,5	-	<b>TNTSASR90-D</b>	-	-	-	£ 713	-	-
--	---------	------	---	--------------------	---	---	---	-------	---	---

HOW TO CHOOSE YOUR PRODUCT USING THE CODES:

NNHR90T-1D

=

NNHR90T-

+

1

+

D

## REQUIRED



### Compulsory

Imperial to Metric flex  
waste adaptor

**RISCCAB**

£ 10

**IN STOCK UK**

(Other products) please check availability



NEW HOLIDAY

IN THE PHOTO: CORNER INSTALLATION - HAMMAM WITH DOME

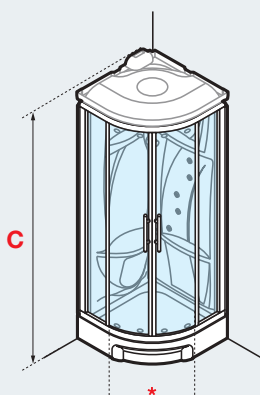

**OPTIONAL**



Shower tray base in impermeable, antibacterial and nontoxic EVA material

90 x 90 cm  
**PEDNTR90**  
£ 79



White led low voltage light  
**WLED CAB**  
£ 102



Blue led low voltage light  
**BLED CAB**  
£ 102

# NEW HOLIDAY R115



200 cm



4 mm



p.  
294-295

## QUADRANT SHOWER CUBICLE

Mixer	Dimensions cm	Total height cm	Access cm	Hand	Code	Glass type	Profile colour / Price		
						1	D	B	K
		<b>C</b>	<b>*</b>			Clear	White	Silver	Chrome

## STANDARD without dome



THERMOSTATIC	112 x 63	211	48	L/H	NNH R 115 S T-		£ 1.449	£ 1.449	£1.522
				R/H	NNH R 115 D T-				

## OPTIONAL DOME FOR STANDARD VERSION

	112 x 63	11	-	L/H	TNTR115S-A	-	£ 256
				R/H	TNTR115D-A		

## HYDROMASSAGE without dome



THERMOSTATIC	112 x 63	211	48	L/H	NNH R 115 S T 19-		£ 1.668	£ 1.668	£1.751
				R/H	NNH R 115 D T 19-				

## OPTIONAL DOME WITH SHOWER HEAD

	112 x 63	11	-	L/H	TNTSOFR115S-D	-	£ 296
				R/H	TNTSOFR115D-D		

## OPTIONAL DOME WITH STEAM GENERATOR AND SHOWER HEAD

	112 x 63	19,5	-	L/H	TNTSASR115S-D	-	£ 713
				R/H	TNTSASR115D-D		

HOW TO CHOOSE YOUR PRODUCT USING THE CODES:

NNHR115ST-1D = NNHR115ST- + 1 + D

## REQUIRED



### Compulsory

Imperial to Metric flex  
waste adaptor

### RISCCAB

£ 10

Please check availability



NEW HOLIDAY

IN THE PHOTO: LEFT INSTALLATION - HAMMAM WITH DOME

**S** INSTALLATION ON THE LEFT

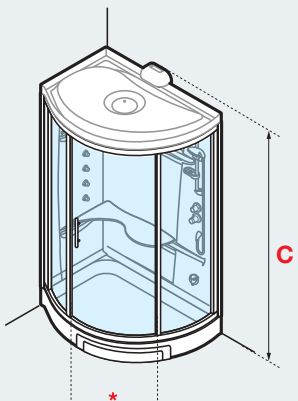

**D** INSTALLATION ON THE RIGHT

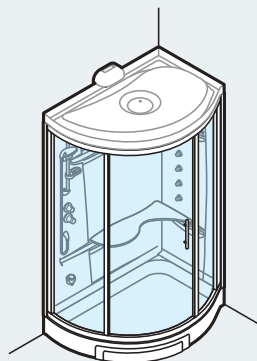

**OPTIONAL**

Shower tray base in impermeable, antibacterial and nontoxic EVA material



left

**PEDNTR115S**

£ 79



right

**PEDNTR115D**

£ 79



White led low voltage light  
**WLED CAB**

£ 102



Blue led low voltage light  
**BLED CAB**

£ 102



# NEW HOLIDAY **GF80**

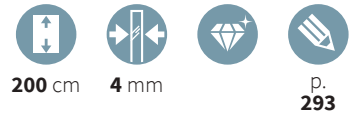

## MULTI FUNCTION SHOWER CUBICLE: PIVOT DOOR AND SIDE PANEL

Mixer	Dimensions cm	Total height cm	Access cm	Code	Glass type			Profile colour / Price		
					1	2	5	D	B	K
					Clear	Aqua	Esprit printing	White	Silver	Chrome

### STANDARD without dome



THERMOSTATIC	80 x 80	206	55	<b>NNH GF 80 T-</b>				£ 1.121	£ 1.121	£1.178
--------------	---------	-----	----	---------------------	--	--	--	---------	---------	--------

### OPTIONAL DOME FOR STANDARD VERSION

	80 x 80	11	-	<b>TNTQ80-A</b>	-	-	-	£ 256		
--	---------	----	---	-----------------	---	---	---	-------	--	--

### HYDROMASSAGE without dome



THERMOSTATIC	80 x 80	206	55	<b>NNH GF 80 T 19-</b>				£ 1.244	£ 1.244	£1.307
--------------	---------	-----	----	------------------------	--	--	--	---------	---------	--------

### OPTIONAL DOME WITH SHOWER HEAD

	80 x 80	11	-	<b>TNTSOFQ80-D</b>	-	-	-	£ 296		
--	---------	----	---	--------------------	---	---	---	-------	--	--

### OPTIONAL DOME WITH STEAM GENERATOR AND SHOWER HEAD

	80 x 80	19,5	-	<b>TNTSASQ80-D</b>	-	-	-	£ 713		
--	---------	------	---	--------------------	---	---	---	-------	--	--

HOW TO CHOOSE YOUR PRODUCT USING THE CODES:

NNHGF80T-1D

=

NNHGF80T-

+

1

+

D

### REQUIRED



#### Compulsory

Imperial to Metric flex  
waste adaptor

#### RISCCAB

£ 10

Please check availability



NEW HOLIDAY

IN THE PHOTO: RIGHT INSTALLATION - HAMMAM WITH DOME

The bottom walls can be inverted for installations on the left or right

INSTALLATION ON THE LEFT

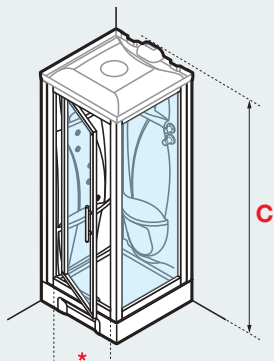

INSTALLATION ON THE RIGHT

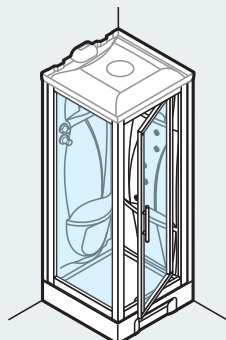

**OPTIONAL**



Shower tray base in impermeable, antibacterial and nontoxic EVA material

80 x 80 cm  
**PEDNTQ80**  
£ 71



White led low voltage light  
**WLED CAB**  
£ 102



Blue led low voltage light  
**BLED CAB**  
£ 102

# NEW HOLIDAY 2P120x80

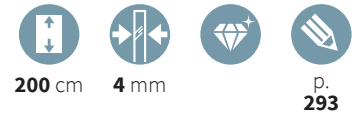

## MULTIFUNCTION SHOWER CUBICLE - SLIDING DOOR AND SIDE PANEL

Mixer	Dimensions cm	Total height cm	Access cm	Code	Glass type			Profile colour / Price		
					1	2	5	D	B	K
					Clear	Aqua	Esprit printing	White	Silver	Chrome

### STANDARD without dome



THERMOSTATIC	120 x 80	206	47	<b>NNH2P 120 T-</b>				£ 1.312	£ 1.312	£1.378
--------------	----------	-----	----	---------------------	--	--	--	---------	---------	--------

### OPTIONAL DOME FOR STANDARD VERSION

	120 x 80	11	-	<b>TNT120-A</b>	-	-	-	£ 256		
--	----------	----	---	-----------------	---	---	---	-------	--	--

### HYDROMASSAGE without dome



THERMOSTATIC	120 x 80	206	47	<b>NNH2P 120 T 19-</b>				£ 1.495	£ 1.495	£1.570
--------------	----------	-----	----	------------------------	--	--	--	---------	---------	--------

### OPTIONAL DOME WITH SHOWER HEAD

	120 x 80	11	-	<b>TNTSOF120-D</b>	-	-	-	£ 296		
--	----------	----	---	--------------------	---	---	---	-------	--	--

### OPTIONAL DOME WITH STEAM GENERATOR AND SHOWER HEAD

	120 x 80	19,5	-	<b>TNTSAS120-D</b>	-	-	-	£ 713		
--	----------	------	---	--------------------	---	---	---	-------	--	--

HOW TO CHOOSE YOUR PRODUCT USING THE CODES:

NNH2P120T-1D = NNH2P120T- + 1 + D

### REQUIRED



#### Compulsory

Imperial to Metric flex  
waste adaptor

#### RISCCAB

£ 10

IN STOCK UK

(Other products) please check availability



NEW HOLIDAY

IN THE PHOTO: RIGHT INSTALLATION - HAMMAM WITH DOME

INSTALLATION ON THE LEFT

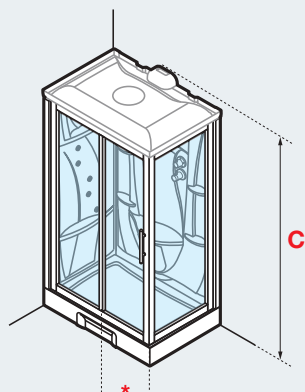

INSTALLATION ON THE RIGHT

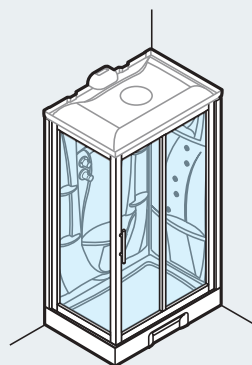

The bottom walls can be inverted for installations on the left or right

OPTIONAL



Shower tray base in impermeable, antibacterial and nontoxic EVA material  
120 x 80 cm  
**PEDNT120**  
£ 79



White led low voltage light  
**WLED CAB**  
£ 102



Blue led low voltage light  
**BLED CAB**  
£ 102

# NEXIS DUAL

COLLECTION **Elysium**

Multifunction complete steam cubicle - 2 sliding doors + 2 fixed panels in line + 2 side panels

## ALL FUNCTIONS AND FEATURES AVAILABLE



 Adjustable hydromassage jets



 2 shower heads  
200x145 mm

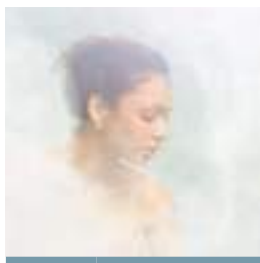

 Steam Plus version



 Aroma dispenser



 2 chromolights



 Touch screen remote control

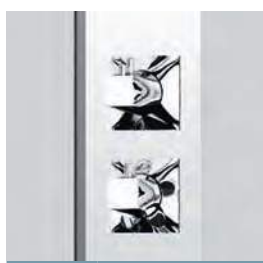

 Thermostatic mixer



 Hand shower in chromed brass



 Folding seat in leafy HPL in wooden finish



 2 Soap holders in leafy HPL in wooden finish



 Bluetooth



 2 Loudspeakers

## REQUIRED



**Compulsory**  
Imperial to Metric flex waste adaptor

**RISCCAB**  
£ 10

## PROFILE COLOURS



Chrome

## GLASS TYPES

(European standards UNI EN 14428)

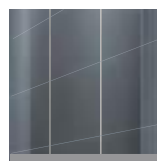

Clear  
8 mm



Back walls glass  
5 mm

## LEAFY HPL WITH WOODEN FINISH



Wood white



Grain



White oak



Burlington



Ash



Wenge

## TREATMENT



**CRYSTAL CLEAR TREATMENT**  
Leaves glass easy to clean. Does not support the growth of bacteria and scale. **Only on transparent glass**



**PVD CHROME FINISH**  
Zero emission integrated cycle, 100% environment-friendly. Antiscale, antibacteria, ecological, long-time shining resistance.



NEXIS DUAL

NEXIS DUAL ▲

# NEXIS DUAL

COLLECTION *lysium*



8 mm GLASS THICKNESS SHOWER ENCLOSURE



5 mm GLASS THICKNESS BACKWALLS



210 cm



p. 296-297

MULTIFUNCTION COMPLETE STEAM CUBICLE  
2 SLIDING DOORS + 2 FIXED PANELS IN LINE + 2 SIDE PANELS

Mixer	Dimensions cm				Code	Select the HPL finish						Price	
	Dimensions	Shower tray	Overall height	Access		A	M	Q	N	P	V		
				<b>C</b>	*		Wood white	Grain	White oak	Burlington	Ash	Wenge	
Thermostatic	170x90	<b>H 8</b>	237	68	<b>NEX 2A 170 T 5-1K</b>							£ 8.383	
		<b>H 15</b>	244	68	<b>NEX 2A 179 T 5-1K</b>								

HOW TO CHOOSE YOUR PRODUCT USING THE CODES:

NEX2A170T5-1KA

= NEX2A170T5-1K

+ A

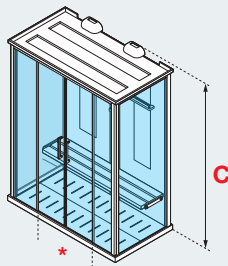

## REQUIRED



### Compulsory

Imperial to Metric flex waste adaptor

### RISCCAB

£ 10

# NEXIS DUAL **A**

COLLECTION *lysium*



8 mm GLASS THICKNESS SHOWER ENCLOSURE



5 mm GLASS THICKNESS BACKWALLS



210 cm



p. 296-297

MULTIFUNCTION COMPLETE STEAM CUBICLE CORNER VERSION  
2 SLIDING DOORS + 2 FIXED PANELS IN LINE + 1 SIDE PANEL

Mixer	Dimensions cm					Code	Select the HPL finish						Price
	Dimensions	Shower tray	Overall height	Access	Side		A	M	Q	N	P	V	
				<b>C</b>	*		Wood white	Grain	White oak	Burlington	Ash	Wenge	
Thermostatic	170x90	<b>H 8</b>	237	68	<b>S</b>	<b>NEX 2A 170 S T 5-1K</b>							£ 8.383
					<b>D</b>	<b>NEX 2A 170 D T 5-1K</b>							
		<b>H 15</b>	244	68	<b>S</b>	<b>NEX 2A 179 S T 5-1K</b>							
					<b>D</b>	<b>NEX 2A 179 D T 5-1K</b>							

HOW TO CHOOSE YOUR PRODUCT USING THE CODES:

NEX2A170ST5-1KA

= NEX2A170ST5-1K

+ A

## S INSTALLATION ON THE LEFT

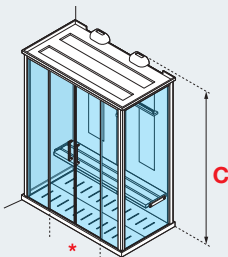

## D INSTALLATION ON THE RIGHT

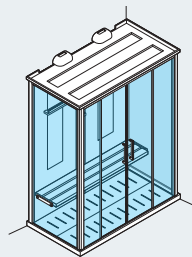

## REQUIRED

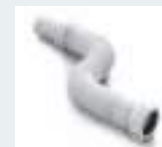

### Compulsory

Imperial to Metric flex waste adaptor

### RISCCAB

£ 10

Made to order only

# NEXIS DUAL



Dome in leafy HPL with finish wood including steam generator



2 shower heads dimensions 220x145 mm



Handshower in chromed brass



Adjustable hydromassage jets

Shower tray footrest in leafy HPL in wooden finish

2 chromolights



2 Loudspeakers and bluetooth



2 Soap holders in leafy HPL in wooden finish



Touch screen remote control for cubicle functions, radio RDS Stereo, clock and alarm



Back + Folding seat in leafy HPL in wooden finish



2 Aroma dispenser



**Wenge**  
version



**Wood white**  
version



**Grain**  
version



**White oak**  
version

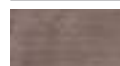

**Burlington**  
version



**Ash**  
version





Multifunction complete steam cubicle

## ALL FUNCTIONS AND FEATURES AVAILABLE

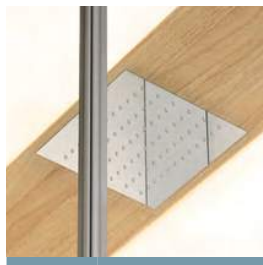

 Adjustable hydromassage jets



 fixed shower head 200x145 mm

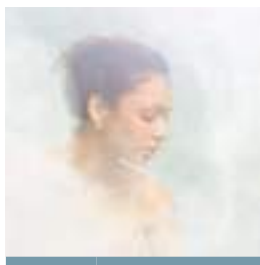

 Steam Plus version



 Aroma dispenser

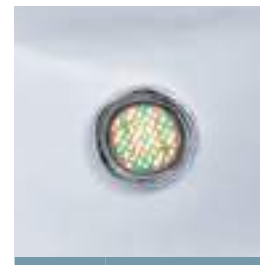

 Cromolight



 Touch screen remote control

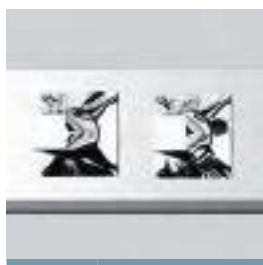

 Thermostatic mixer



 Hand shower



 Folding seat + Back in leafy HPL in wooden finish

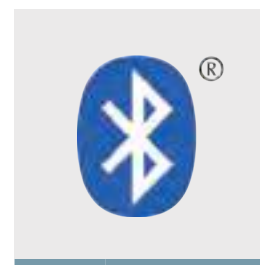

 Bluetooth



 RDS Stereo with 2 Loudspeakers

## REQUIRED



**Compulsory**  
Imperial to Metric flex waste adaptor

**RISCCAB**  
£ 10

## PROFILE COLOURS



Chrome

## GLASS TYPES (European standards UNI EN 14428)

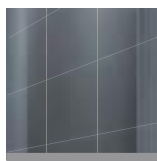

Clear 8 mm



Back walls glass 5 mm

## LEAFY HPL WITH WOODEN FINISH



Wood white Grain



White oak



Burlington



Ash



Wenge

## TREATMENT



**CRYSTAL CLEAR TREATMENT**  
Leaves glass easy to clean. Does not support the growth of bacteria and scale. **Only on transparent glass**



**PVD CHROME FINISH**  
Zero emission integrated cycle, 100% environment-friendly. Antiscale, antibacteria, ecological, long-time shining resistance.



NEXIS

# NEXIS A90

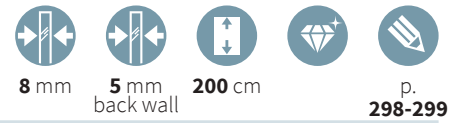

MULTIFUNCTION COMPLETE STEAM CUBICLE - CORNER ENTRY - 2 SLIDING DOORS + 2 FIXED PANELS IN LINE

COLLECTION *lysium*

Mixer	Dimensions cm	Shower tray cm	Overall height cm	Access cm	Code	Select the HPL finish						Price
						A	M	Q	N	P	V	
			<b>C</b>	*		Wood white	Grain	White oak	Burlington	Ash	Wenge	

## HYDRO



	90 x 90	<b>H 8</b>	209	45	<b>NEXA 90 T 1 F- 1K</b>							£ 3.569
THERMOSTATIC	90 x 90	<b>H 15</b>	216	45	<b>NEXA 99 T 1 F- 1K</b>							£ 3.569

## HAMMAM



	90 x 90	<b>H 8</b>	227	45	<b>NEXA 90 T 5- 1K</b>							£ 4.950
THERMOSTATIC	90 x 90	<b>H 15</b>	234	45	<b>NEXA 99 T 5- 1K</b>							£ 4.950

HOW TO CHOOSE YOUR PRODUCT USING THE CODES:

NEXA90T1F-1KA

=

NEXA90T1F-1K

+

A

## REQUIRED



### Compulsory

Imperial to Metric flex waste adaptor

**RISCCAB**

£ 10

Please check availability



COLLECTION **lysium**

IN THE PHOTO: HAMMAM WITH DOME

NEXIS

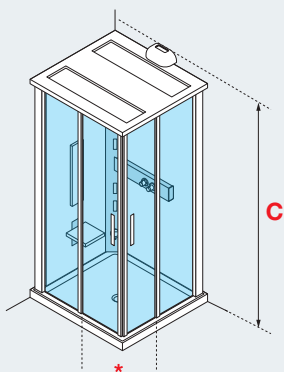

Shower tray footrest in leafy HPL in wooden finish

# NEXIS R90

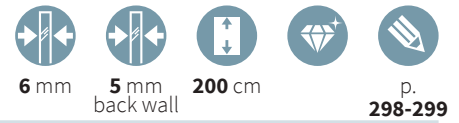

MULTIFUNCTION COMPLETE STEAM CUBICLE - QUADRANT - 2 SLIDING DOORS + 2 FIXED PANELS

COLLECTION *lysium*

Mixer	Dimensions cm	Shower tray cm	Overall height cm	Access cm	Code	Select the HPL finish						Price
						A	M	Q	N	P	V	
			<b>C</b>	*		Wood white	Grain	White oak	Burlington	Ash	Wenge	

## HYDRO



	90 x 90	<b>H 8</b>	209	48	<b>NEXR 90 T 1 F- 1K</b>							£ 3.678
THERMOSTATIC	90 x 90	<b>H 15</b>	216	48	<b>NEXR 99 T 1 F- 1K</b>							£ 3.678

## HAMMAM



	90 x 90	<b>H 8</b>	227	48	<b>NEXR 90 T 5- 1K</b>							£ 5.045
THERMOSTATIC	90 x 90	<b>H 15</b>	234	48	<b>NEXR 99 T 5- 1K</b>							£ 5.045

HOW TO CHOOSE YOUR PRODUCT USING THE CODES:

NEXR90T1F-1KA

=

NEXR90T1F-1K

+

A

## REQUIRED



### Compulsory

Imperial to Metric flex waste adaptor

**RISCCAB**

£ 10

Please check availability



COLLECTION **lysium**

IN THE PHOTO: HAMMAM WITH DOME

NEXIS

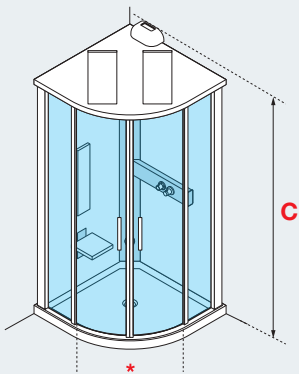

Shower tray footrest in leafy HPL in wooden finish

# NEXIS A120x80 - A100x80



8 mm



5 mm back wall



200 cm



p. 298-299

MULTIFUNCTION COMPLETE STEAM CUBICLE - OFFSET CORNER ENTRY - 2 SLIDING DOORS + 2 FIXED PANELS IN LINE

COLLECTION **lysium**

Mixer	Dimensions cm	Shower tray cm	Overall height cm	Access cm	Side	Code	Select the HPL finish						Price
							A	M	Q	N	P	V	
							Wood white	Grain	White oak	Burlington	Ash	Wenge	

**C \***

## HYDRO



THERMOSTATIC	120 x 80	H 8	209	52	D	NEX A 120 D T 1 F- 1K		£ 3.948	
					S	NEX A 120 S T 1 F- 1K			
	H 15	216	52	D	NEX A 129 D T 1 F- 1K	£ 3.948			
				S	NEX A 129 S T 1 F- 1K				
	100 x 80	H 8	209	45	D	NEX A 100 D T 1 F- 1K			£ 3.732
					S	NEX A 100 S T 1 F- 1K			
H 15	216	45	D	NEX A 109 D T 1 F- 1K	£ 3.732				
			S	NEX A 109 S T 1 F- 1K					

## HAMMAM



THERMOSTATIC	120 x 80	H 8	227	52	D	NEX A 120 D T 5- 1K		£ 5.331	
					S	NEX A 120 S T 5- 1K			
	H 15	234	52	D	NEX A 129 D T 5- 1K	£ 5.331			
				S	NEX A 129 S T 5- 1K				
	100 x 80	H 8	227	45	D	NEX A 100 D T 5- 1K			£ 5.140
					S	NEX A 100 S T 5- 1K			
H 15	234	45	D	NEX A 109 D T 5- 1K	£ 5.140				
			S	NEX A 109 S T 5- 1K					

HOW TO CHOOSE YOUR PRODUCT USING THE CODES:

NEXA120ST1F-1KA

=

NEXA120ST1F-1K

+ A

## REQUIRED



### Compulsory

Imperial to Metric flex waste adaptor

RISCCAB

£ 10

Please check availability



COLLECTION **zlysium**

IN THE PHOTO: HAMMAM WITH DOME

NEXIS

**S** INSTALLATION ON THE LEFT

**D** INSTALLATION ON THE RIGHT

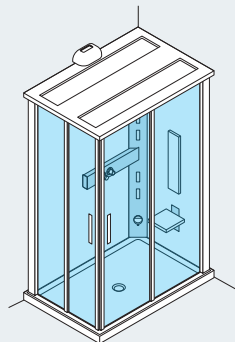
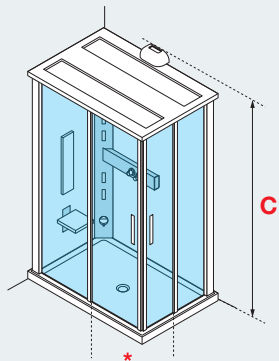

Shower tray footrest in leafy HPL in wooden finish



# CRYSTAL

COLLECTION **Elysium**

The Novellini Shower cubicle with decorated glass back walls.  
This Easy to clean cubicle shows a essential design, being a modern and elegant wellness area for your bathroom.

## ALL FUNCTIONS AND FEATURES AVAILABLE

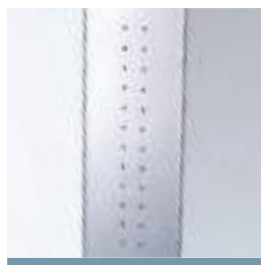

Body hydromassage



Shower head  
200 x 200 mm

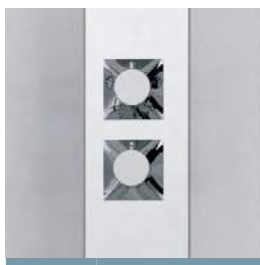

Thermostatic mixer



Hand shower



Folding seat  
max kg 120



Glass/chrome  
shelf

## REQUIRED



### Compulsory

Imperial to Metric flex  
waste adaptor

### RISCCAB

£ 10

## PROFILE COLOURS



Silver

Chrome

## BACKGROUND PANEL FINISHING (5 mm)



White

Black

Black  
serigraphy

White  
serigraphy

## GLASS TYPES

(European standards UNI EN 14428)

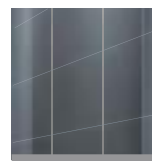

Clear  
6 mm

## TREATMENT



### CRYSTAL CLEAR TREATMENT

Leaves glass easy to clean. Does not support the growth of bacteria and scale.  
**Only on clear glass**



### PVD CHROME FINISH

Zero emission production integrated cycle, 100% environmentally friendly. Antiscala, antibacterial, durable and long lasting shine.



CRYSTAL

# CRYSTAL R90



p.  
300-301

QUADRANT, 2 SLIDING DOORS + 2 FIXED PANELS

COLLECTION *Elysium*

Mixer	Shower tray cm	Overall height cm	Access cm	Code	Glass	Profile type		Selección acabado paneles					
								Background colour		Price	Background colour with pattern		Price
					1	B	K	A	H		66	67	
					Clear	Silver	Chrome	White	Black		Print. Black	Print. White	

**C** \*

## STANDARD



THERMOSTATIC	<b>H 8</b>	220	49	<b>HC2 R 90 T-</b>						£ 1.985			£2.120
	<b>H 15</b>	227	49	<b>HC2 R 99 T-</b>						£ 1.985			£2.120

## HYDRO



THERMOSTATIC	<b>H 8</b>	220	49	<b>HC2 R 90 T 1-</b>						£ 2.094			£2.229
	<b>H 15</b>	227	49	<b>HC2 R 99 T 1-</b>						£ 2.094			£2.229

HOW TO CHOOSE YOUR PRODUCT USING THE CODES:

HC2R99T1-1BA = HC2R99T1- + 1 + B + A

## REQUIRED



### Compulsory

Imperial to Metric flex waste adaptor

**RISCCAB**

£ 10

Please check availability



CRYSTAL

COLLECTION *lysium*

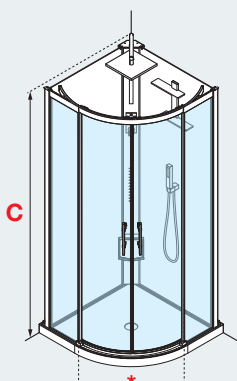

# CRYSTAL 2P 120x80



p.  
300-301

SLIDING DOOR+FIXED PANEL IN LINE + SIDE PANEL

COLLECTION **Elysium**

Mixer	Shower tray cm	Overall height cm	Access cm	Side	Code	Glass	Profile type		Selección acabado paneles					
							B	K	Background colour		Price	Background colour with pattern		Price
						1						A	H	
						Clear	Silver	Chrome	White	Black		Print. Black	Print. White	

C

\*

## STANDARD



THERMOSTATIC	H 8	220	48	S	HC2 2P 120 S T-	B	K	A	H	£ 1.841	Print. Black	Print. White	£ 1.976
	H 15	227	48	S	HC2 2P 129 S T-					£ 1.841			£ 1.976
				D	HC2 2P 129 D T-					£ 1.841			£ 1.976

## HYDRO



THERMOSTATIC	H 8	220	48	S	HC2 2P 120 S T 1-	B	K	A	H	£ 1.949	Print. Black	Print. White	£ 2.084
	H 15	227	48	S <td>HC2 2P 129 S T 1- <td></td> <td></td> <td></td> <td></td> <td>£ 1.949</td> <td></td> <td></td> <td>£ 2.084</td> </td>	HC2 2P 129 S T 1- <td></td> <td></td> <td></td> <td></td> <td>£ 1.949</td> <td></td> <td></td> <td>£ 2.084</td>					£ 1.949			£ 2.084
				D <td>HC2 2P 129 D T 1- <td></td> <td></td> <td></td> <td></td> <td>£ 1.949</td> <td></td> <td></td> <td>£ 2.084</td> </td>	HC2 2P 129 D T 1- <td></td> <td></td> <td></td> <td></td> <td>£ 1.949</td> <td></td> <td></td> <td>£ 2.084</td>					£ 1.949			£ 2.084

HOW TO CHOOSE YOUR PRODUCT USING THE CODES:

HC22P129DT1-1BA = HC22P129DT1- + 1 + B + A

## REQUIRED



### Compulsory

Imperial to Metric flex waste adaptor

RISCCAB

£ 10

Please check availability



COLLECTION **lysium**

CRYSTAL

PICTURE: RIGHT HAND VERSION

**S**  
INSTALLATION ON THE LEFT

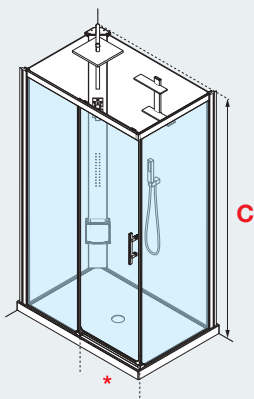

**D**  
INSTALLATION ON THE RIGHT

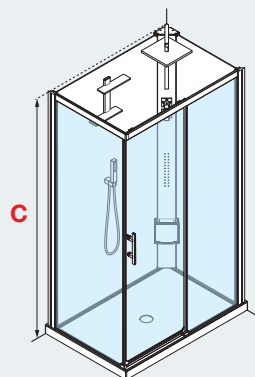

# CRISTALLO 2

COLLECTION **Elysium**

Stylish and contemporary, quality product throughout. High function shower cabin. A joy to use due to the ergonomic design. Low maintenance due to the sleek glass walls and silicone free installation, No tiles or grout required. Easy to install and service. Jump in and enjoy.

## ALL FUNCTIONS AND FEATURES AVAILABLE



Shower head



Manual or  
Thermostatic mixer

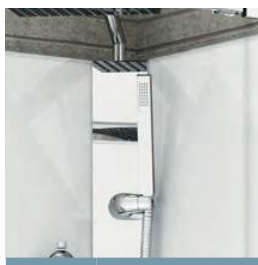

Hand shower

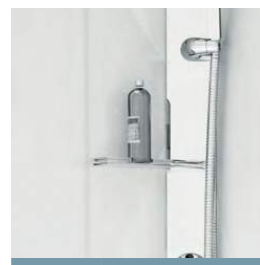

Glass/chrome  
shelf



Crystal glass handles

## REQUIRED



### Compulsory

Imperial to Metric flex  
waste adaptor

**RISCCAB**

£ 10

## OPTIONAL

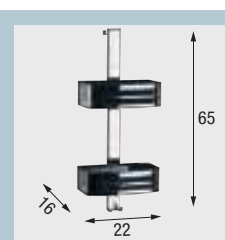

### Double hanging baskets

slotted

**R90CESTE0E-A** (White)

**R90CESTE0E-H** (Black)

£ 179

## PROFILE COLOURS



Chrome

## GLASS PANEL FINISHING (5 mm)



White



Black



Red



Grey

## GLASS TYPES

(European standards UNI EN 14428)

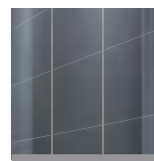

Clear  
6 mm

## TREATMENT



### CRYSTAL CLEAR TREATMENT

Leaves glass easy to clean. Does not  
support the growth of bacteria and scale.  
**Only on clear glass**



### PVD CHROME FINISH

Zero emission production integrated cycle,  
100% environmentally friendly. Antiscale,  
antibacterial, durable and long lasting shine.



CRISTALLO 2



# CRISTALLO 2 R90

COLLECTION *Elysium*



6 mm



p.  
490-491

QUADRANT COMPLETE CUBICLE, EQUIPPED PANEL  
OPTIONAL 4 JET VERTICAL HYDROMASSAGE

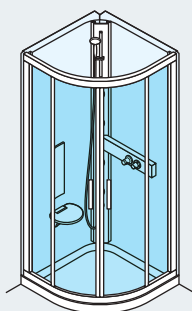

Dimensions	Shower tray cm	Total height cm	Code	Glass panel				Price
				A	H	R	G	
		<b>C</b>		White	Black	Red	Grey	

## STANDARD



90x90	<b>H 8</b>	206	<b>CU2R99T- 1K</b>	•	•	•	•	£ 1.782
	<b>H 15</b>	213	<b>CU2R90T- 1K</b>					

## HYDRO



90x90	<b>H 8</b>	206	<b>CU2R99T1- 1K</b>	•	•	•	•	£ 2.019
	<b>H 15</b>	213	<b>CU2R90T1- 1K</b>					

### REQUIRED



#### Compulsory

Imperial to Metric  
flex waste adaptor

#### RISCCAB

£ 10

HOW TO CHOOSE YOUR PRODUCT USING THE CODES:

CU2R99T-1KA

= CU2R99T-1K

+ A

# CRISTALLO 2 **GF80**

COLLECTION *elysium*



6 mm



p.  
490-491

PIVOT DOOR + SIDE PANEL COMPLETE CUBICLE, EQUIPPED PANEL  
OPTIONAL 4 JET VERTICAL HYDROMASSAGE

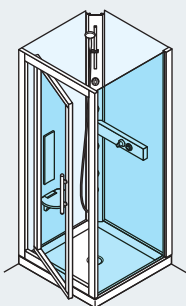

Dimensions	Shower tray cm	Total height cm	Code	Glass panel				Price
				A	H	R	G	
		<b>C</b>		White	Black	Red	Grey	

## STANDARD



80x80	<b>H 8</b>	206	<b>CU2GF89T- 1K</b>					£ 1.782
	<b>H 15</b>	213	<b>CU2GF80T- 1K</b>					

## HYDRO



80x80	<b>H 8</b>	206	<b>CU2GF89T1- 1K</b>					£ 2.019
	<b>H 15</b>	213	<b>CU2GF80T1- 1K</b>					

### REQUIRED



#### Compulsory

Imperial to Metric  
flex waste adaptor

#### RISCCAB

£ 10

HOW TO CHOOSE YOUR PRODUCT USING THE CODES:

CU2GF89T-1KA

= CU2GF89T-1K

+ A

# CRISTALLO 2 2P120

COLLECTION *Elysium*



6 mm



p.  
490-491

CORNER ENTRY COMPLETE CUBICLE, EQUIPPED PANEL  
OPTIONAL 4 JET VERTICAL HYDROMASSAGE



### REQUIRED



**Compulsory**  
Imperial to Metric  
flex waste adaptor

**RISCCAB**

£ 10

### LEFT HAND

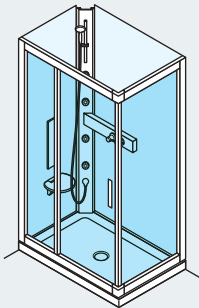

### RIGHT HAND

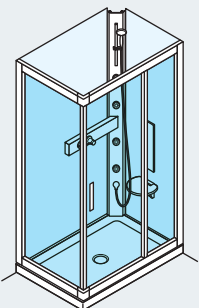

Dimensions	Shower tray cm	Total height cm	Code	Glass panel				Price
				A	H	R	G	
				White	Black	Red	Grey	

**C**

### STANDARD



120x80	H 8	206	<b>LEFT HAND</b>	CU22P129ST- 1K	●	●	●	●	£ 1.782
	H 15	213		CU22P120ST- 1K					
	H 8	206	<b>RIGHT HAND</b>	CU22P129DT- 1K					
	H 15	213		CU22P120DT- 1K					

### HYDRO



120x80	H 8	206	<b>LEFT HAND</b>	CU22P129ST1- 1K	●	●	●	●	£ 2.019
	H 15	213		CU22P120ST1- 1K					
	H 8	206	<b>RIGHT HAND</b>	CU22P129DT1- 1K					
	H 15	213		CU22P120DT1- 1K					

HOW TO CHOOSE YOUR PRODUCT USING THE CODES:

CU22P129ST-1KA

=

CU22P129ST-1K

+

A



CRISTALLO 2

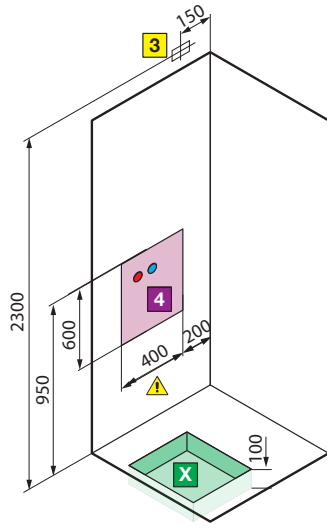
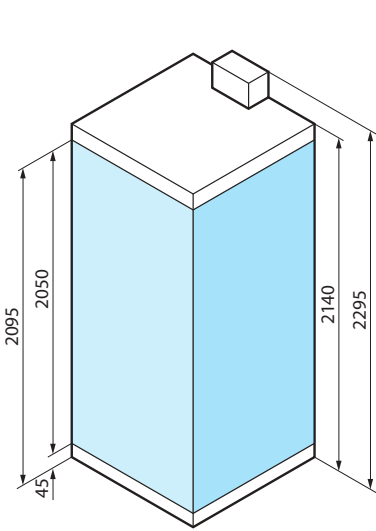

for models  
**A80 - A90 - R90**

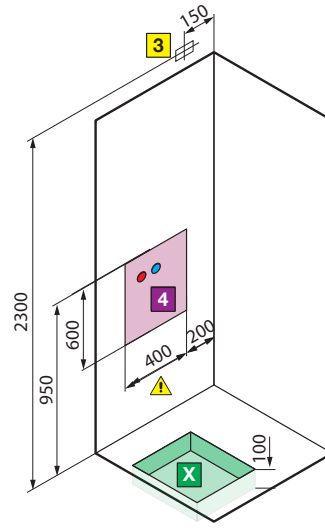

**left version**  
for models **A100x80 - 2P120x80 - 2P120x90**

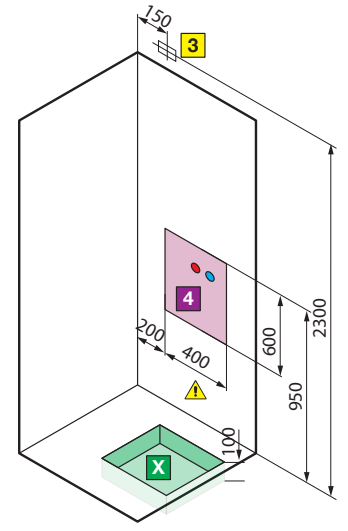

**right version**  
for models **A100x80 - 2P120x80 - 2P120x90**

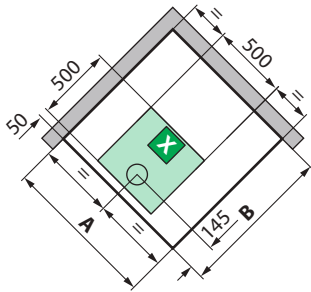

model	A ± 4	B ± 4
<b>A80</b>	802	802
<b>A90</b>	902	902

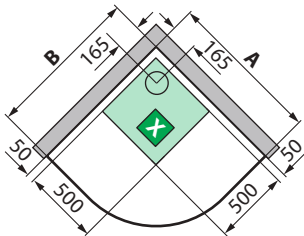

model	A ± 4	B ± 4
<b>R90</b>	902	902

**S** INSTALLATION ON THE LEFT

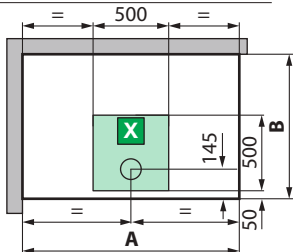

**D** INSTALLATION ON THE RIGHT

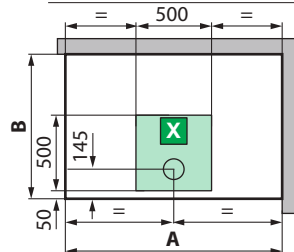

model	A ± 4	B ± 4
<b>A100x80</b>	1002	802
<b>2P120x80</b>	1202	802
<b>2P120x90</b>	1202	902

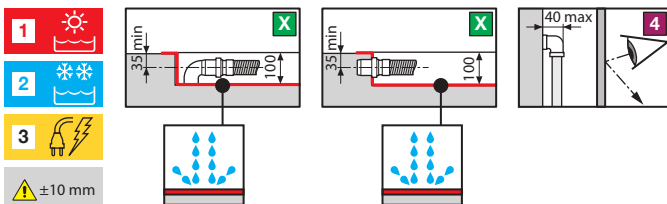

**HYDRAULIC CHARACTERISTIC:**

Optimum dynamic pressure 2-5 bar  
1/2" hot water connection  
Cold water connection 1/2"  
Siphon connection with ø 40 mm coupling

**ELECTRICAL CHARACTERISTIC:**

Supply voltage 220-230 V  
Frequency 50/60 Hz  
Max. absorbed power PLUS: 2600 W  
Max. absorbed power BASE and IDRO: 50 W

**WARNING:** The whirlpool bath system must be fitted upstream with a 30 mA circuit breaker with a minimum contact of 3mm. **It could be dangerous for pacemaker wearer**

# EON shower tray 115 mm

## TECHNICAL DRAWINGS

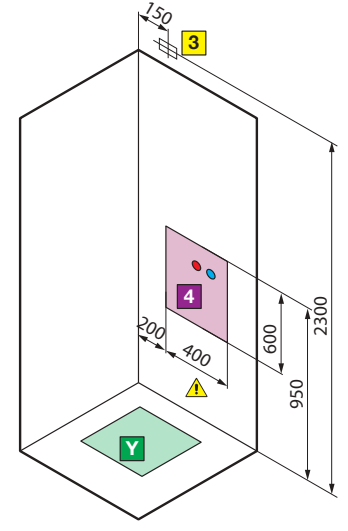
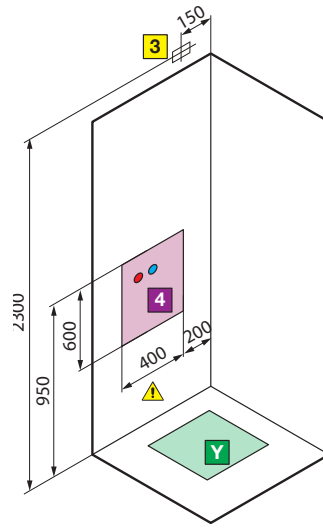
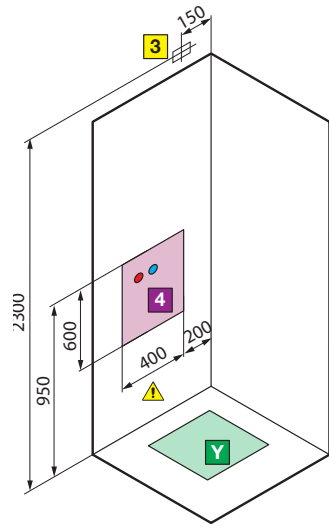
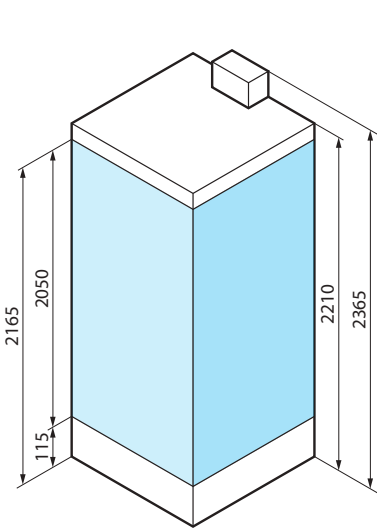

for models  
**A80 - A90 - R90**

**left version**

**right version**  
for models **A100x80 - 2P120x80 - 2P120x90**

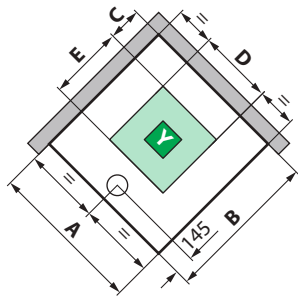

model	A ± 4	B ± 4	C	D	E
<b>A80</b>	802	802	150	400	400
<b>A90</b>	902	902	150	500	500

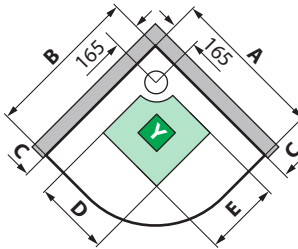

model	A ± 4	B ± 4	C	D	E
<b>R90</b>	902 ± 4	902	156	500	500

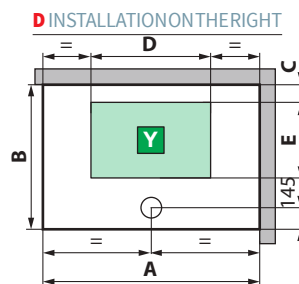
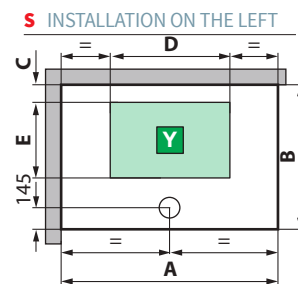

model	A ± 4	B ± 4	C	D	E
<b>A100x80</b>	1002	802	150	600	400
<b>2P120x80</b>	1202	802	150	800	400
<b>2P120x90</b>	1202	902	150	800	500

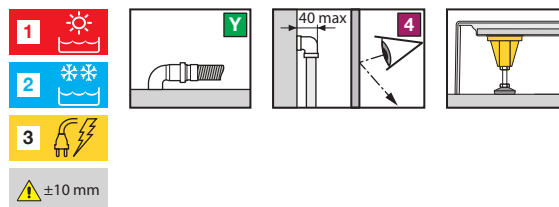

**HYDRAULIC CHARACTERISTIC:**  
Optimum dynamic pressure 2-5 bar  
1/2" hot water connection  
Cold water connection 1/2"  
Siphon connection with ø 40 mm coupling

**ELECTRICAL CHARACTERISTIC:**  
Supply voltage 220-230 V  
Frequency 50/60 Hz  
Max. absorbed power PLUS: 2600 W  
Max. absorbed power BASE and IDRO: 50 W

**WARNING:** The whirlpool bath system must be fitted upstream with a 30 mA circuit breaker with a minimum contact of 3mm. **It could be dangerous for pacemaker wearer**

# GLAX 3 shower tray 80 mm

## TECHNICAL DRAWINGS

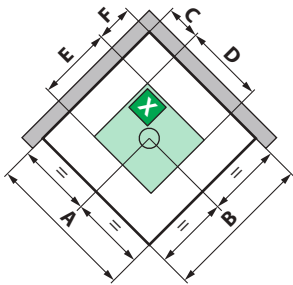
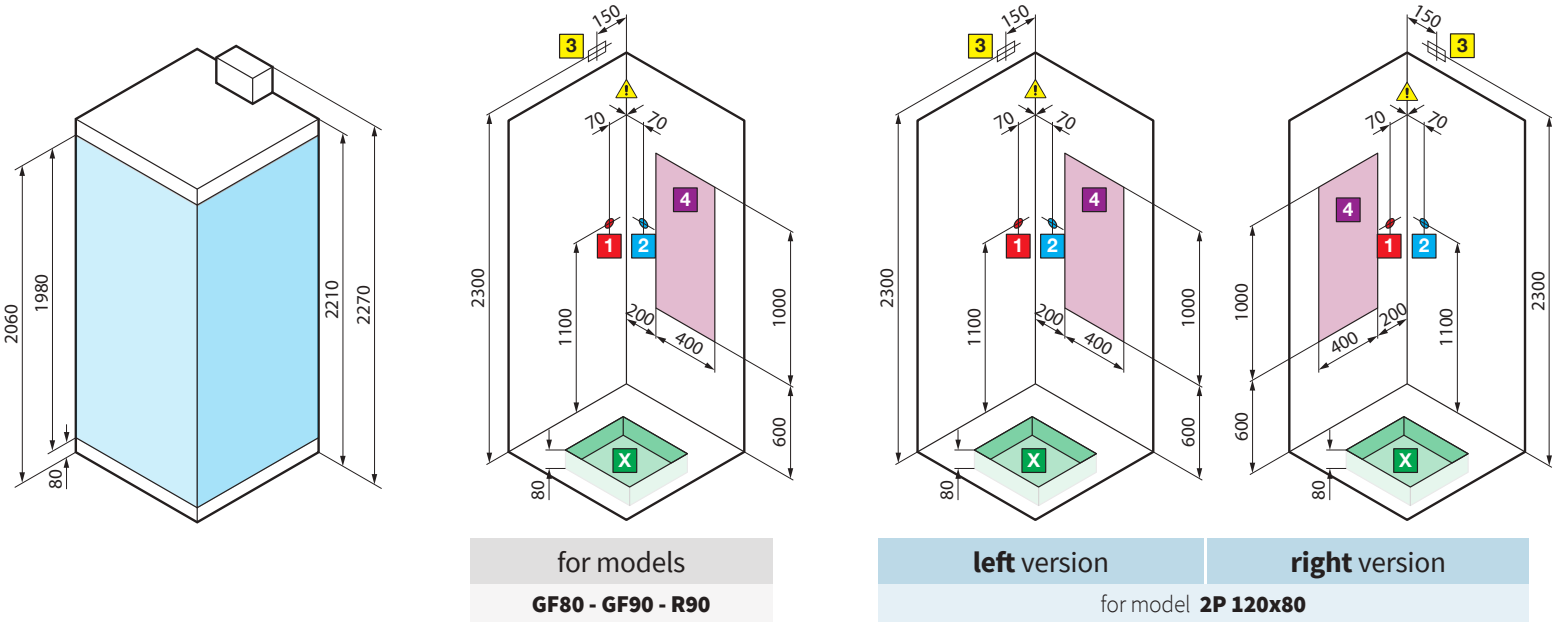

model	A ± 2	B ± 2	C	D	E	F
<b>GF80</b>	800	800	100	500	450	225
<b>GF90</b>	900	900	150	500	450	275

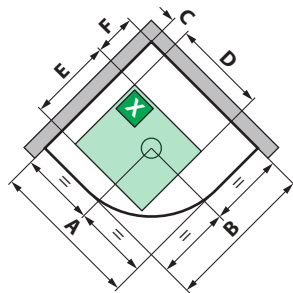

model	A ± 2	B ± 2	C	D	E	F
<b>R90</b>	900	900	150	500	450	275

### S INSTALLATION ON THE LEFT

### D INSTALLATION ON THE RIGHT

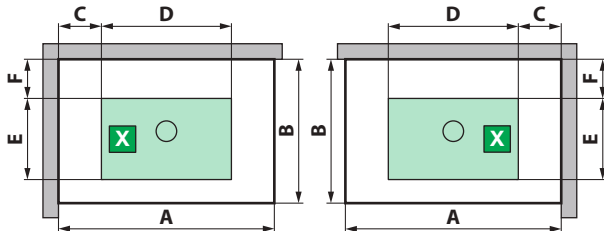

model	A ± 2	B ± 2	C	D	E	F
<b>2P120x80</b>	1200	800	200	600	450	220

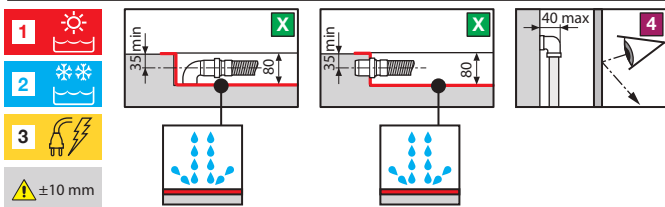

#### HYDRAULIC CHARACTERISTIC:

Optimum dynamic pressure 2-5 bar  
 1/2" hot water connection  
 Cold water connection 1/2"  
 Siphon connection with ø 40 mm coupling

#### ELECTRICAL CHARACTERISTIC (Glax 3):

Supply voltage 220-230 V  
 Frequency 50/60 Hz  
 Maximum absorbed power: 3300 W  
 Nominal power: 2500 W

**WARNING:** The whirlpool bath system must be fitted upstream with a 30 mA circuit breaker with a minimum contact of 3mm. **It could be dangerous for pacemaker wearer**

# GLAX 3 shower tray 150 mm

## TECHNICAL DRAWINGS

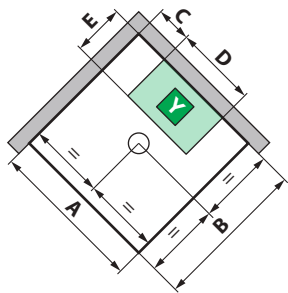
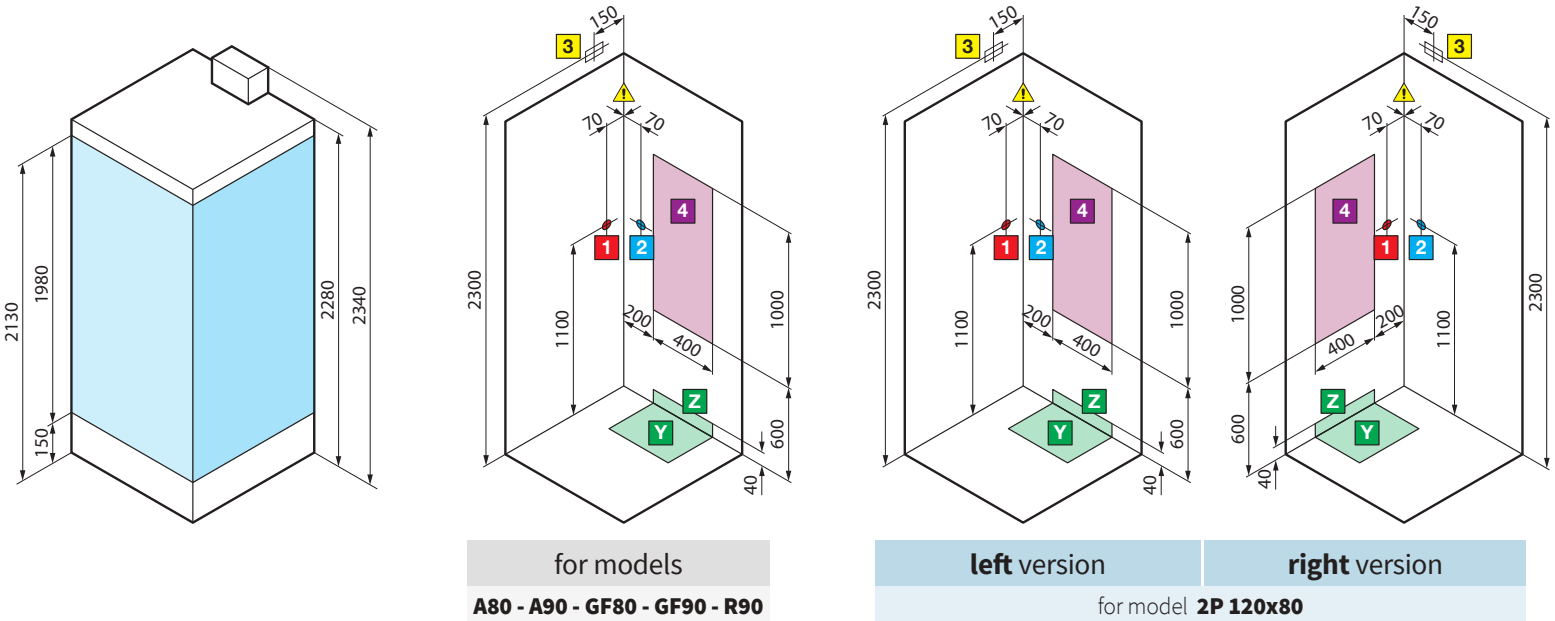

model	A ± 4	B ± 4	C	D	E
GF80	800	800	200	400	300
GF90	900	900	200	500	300

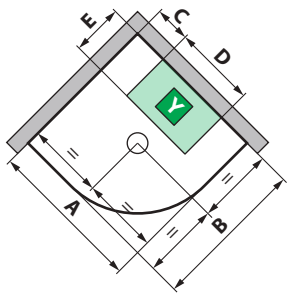

model	A ± 4	B ± 4	C	D	E
R90	900	900	200	500	300

### S INSTALLATION ON THE LEFT

### D INSTALLATION ON THE RIGHT

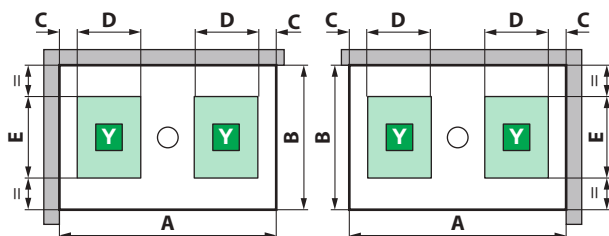

model	A ± 4	B ± 4	C	D	E
2P120x80	1200	800	100	350	450

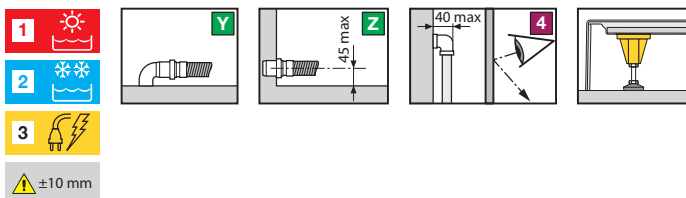

### HYDRAULIC CHARACTERISTIC:

Optimum dynamic pressure 2-5 bar  
 1/2" hot water connection  
 Cold water connection 1/2"  
 Siphon connection with ø 40 mm coupling

### ELECTRICAL CHARACTERISTIC (Glax 3):

Supply voltage 220-230 V  
 Frequency 50/60 Hz  
 Maximum absorbed power: 3300 W  
 Nominal power: 2500 W

**WARNING:** The whirlpool bath system must be fitted upstream with a 30 mA circuit breaker with a minimum contact of 3mm. **It could be dangerous for pacemaker wearer**



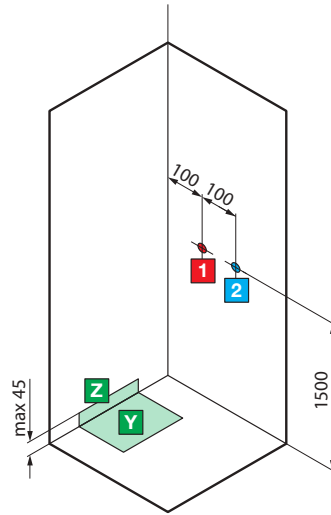
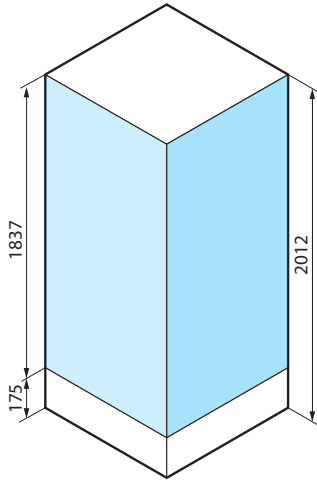

for models  
**A80 - A90 - GF80 - GF90**

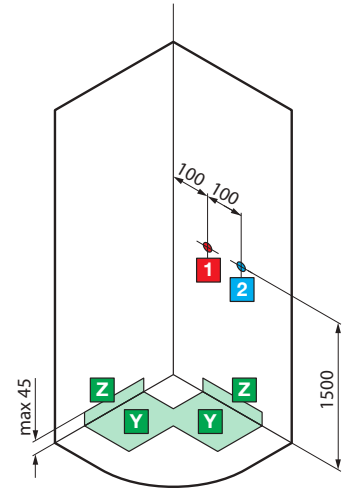

for model  
**R90**

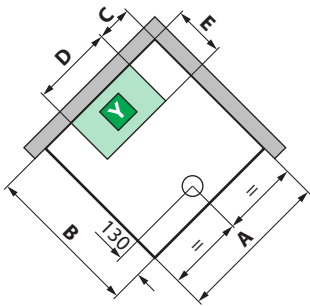

Model	A ± 5	B ± 5	C	D	E
<b>A80</b>	804	804	200	404	300
<b>A90</b>	904	904	200	504	300
<b>GF80</b>	804	804	200	404	300
<b>GF90</b>	904	904	200	504	300

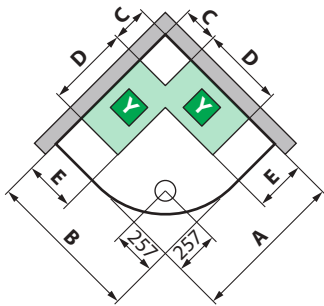

Model	A ± 5	B ± 5	C	D	E
<b>R90</b>	904	904	200	504	300

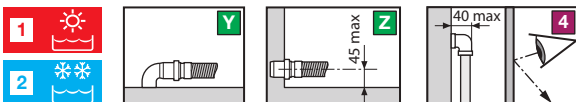

**HYDRAULIC CHARACTERISTIC:**  
 Optimum dynamic pressure 2-5 bar  
 1/2" hot water connection  
 Cold water connection 1/2"  
 Siphon connection with ø 40 mm coupling

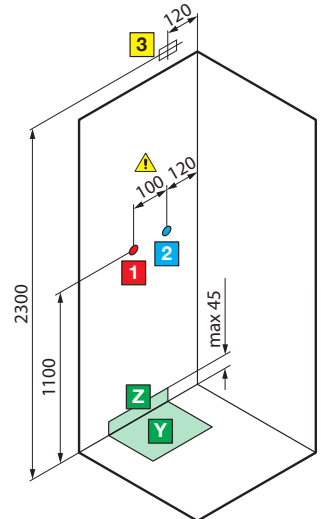
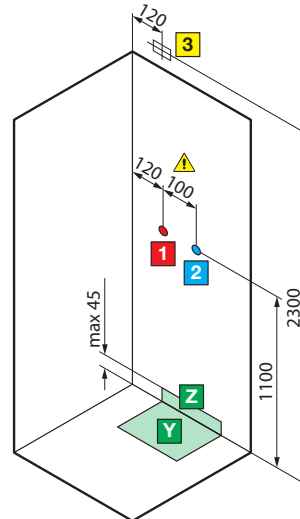
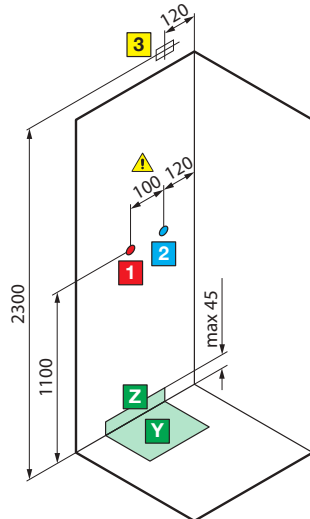
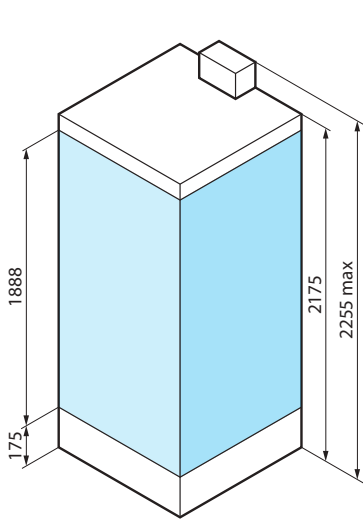

for models

**GF90**

**left version**

**right version**

for models **2P120x80**

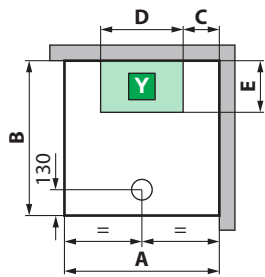

model	A ± 5	B ± 5	C	D	E
<b>GF90</b>	904	904	200	504	300

**S** INSTALLATION ON THE LEFT

**D** INSTALLATION ON THE RIGHT

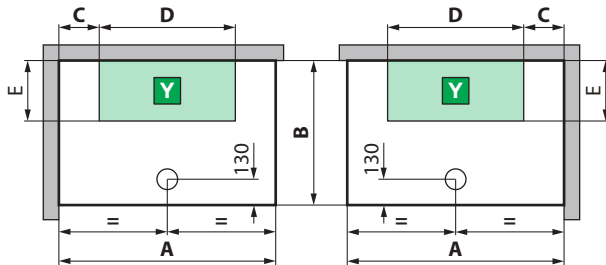

model	A ± 5	B ± 5	C	D	E
<b>2P120x80</b>	1204	804	200	804	300

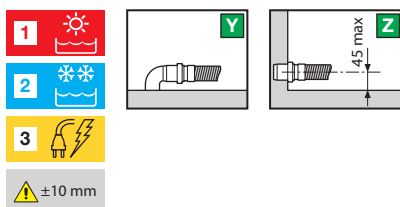

**HYDRAULIC CHARACTERISTIC:**  
 Optimum dynamic pressure 2-5 bar  
 1/2" hot water connection  
 Cold water connection 1/2"  
 Siphon connection with ø 40 mm coupling

**ELECTRICAL CHARACTERISTIC:**  
 Supply voltage 220-230 V  
 Frequency 50/60 Hz  
 Maximum absorbed power: 2600 W  
 Nominal power: 2500 W

**WARNING:** The whirlpool bath system must be fitted upstream with a 30 mA circuit breaker with a minimum contact of 3mm. **It could be dangerous for pacemaker wearers**

## MOD. R90

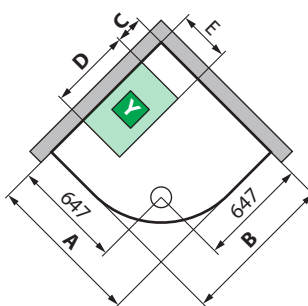
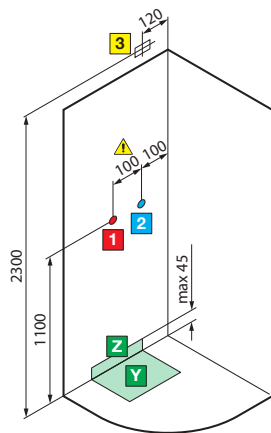
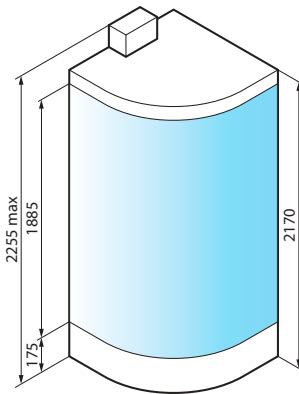

mod.	A ± 5	B ± 5	C	D	E
<b>R90</b>	904	904	200	504	300

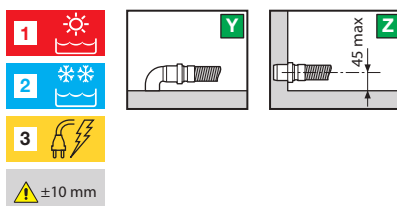

### HYDRAULIC CHARACTERISTIC:

Optimum dynamic pressure 2-5 bar  
 1/2" hot water connection  
 Cold water connection 1/2"  
 Siphon connection with ø 40 mm coupling

### ELECTRICAL CHARACTERISTIC:

Supply voltage 220-230 V  
 Frequency 50/60 Hz  
 Maximum absorbed power: 2600 W  
 Nominal power: 2500 W

**WARNING:** The whirlpool bath system must be fitted upstream with a 30 mA circuit breaker with a minimum contact of 3mm. **It could be dangerous for pacemaker wearer**

## MOD. R115

**S** INSTALLATION ON THE LEFT

**D** INSTALLATION ON THE RIGHT

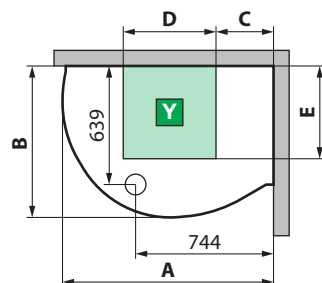
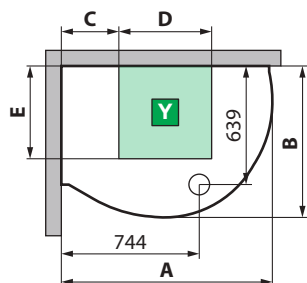
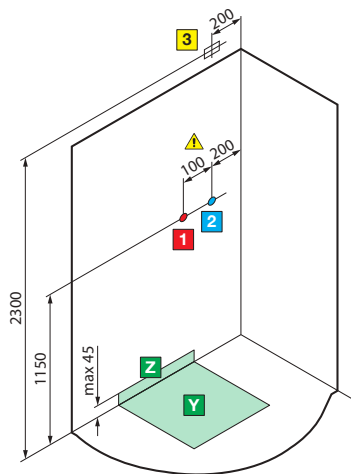
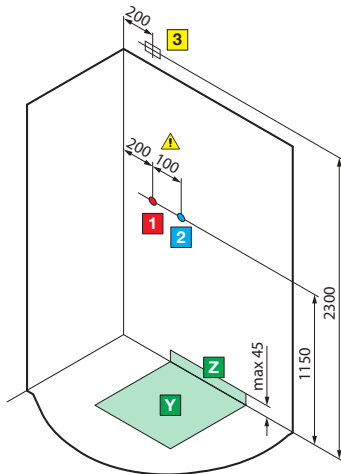
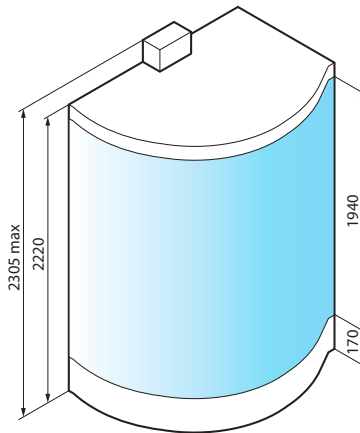
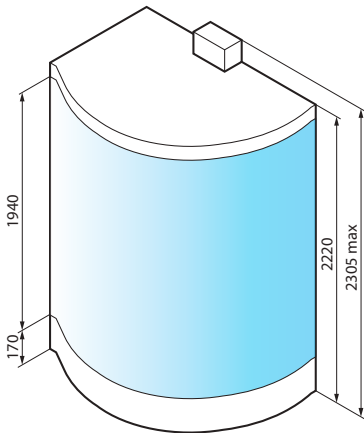

mod.	A ± 5	B ± 5	C	D	E
<b>R115</b>	1138	817	310	500	500

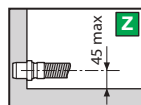
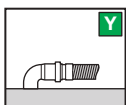
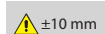

**HYDRAULIC CHARACTERISTIC:**  
 Optimum dynamic pressure 2-5 bar  
 1/2" hot water connection  
 Cold water connection 1/2"  
 Siphon connection with ø 40 mm coupling

**ELECTRICAL CHARACTERISTIC:**  
 Supply voltage 220-230 V  
 Frequency 50/60 Hz  
 Maximum absorbed power: 2600 W  
 Nominal power: 2500 W

**WARNING:** The whirlpool bath system must be fitted upstream with a 30 mA circuit breaker with a minimum contact of 3mm. **It could be dangerous for pacemaker wearer**

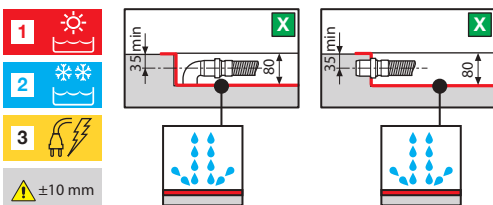
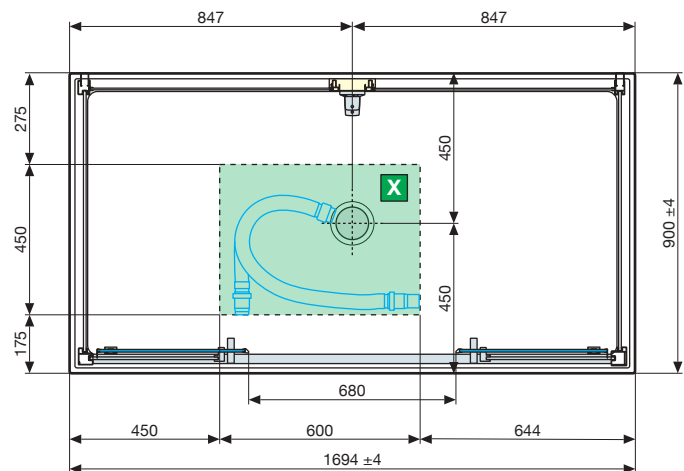
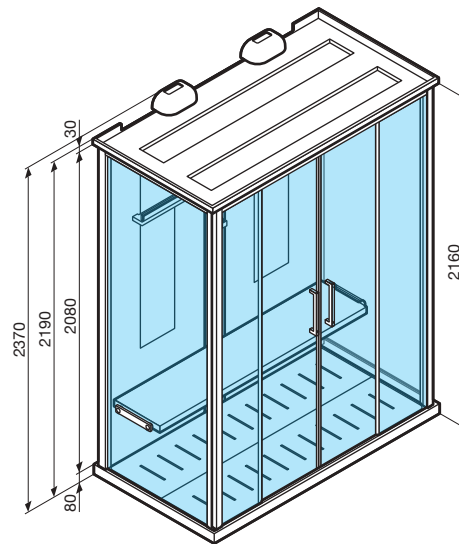
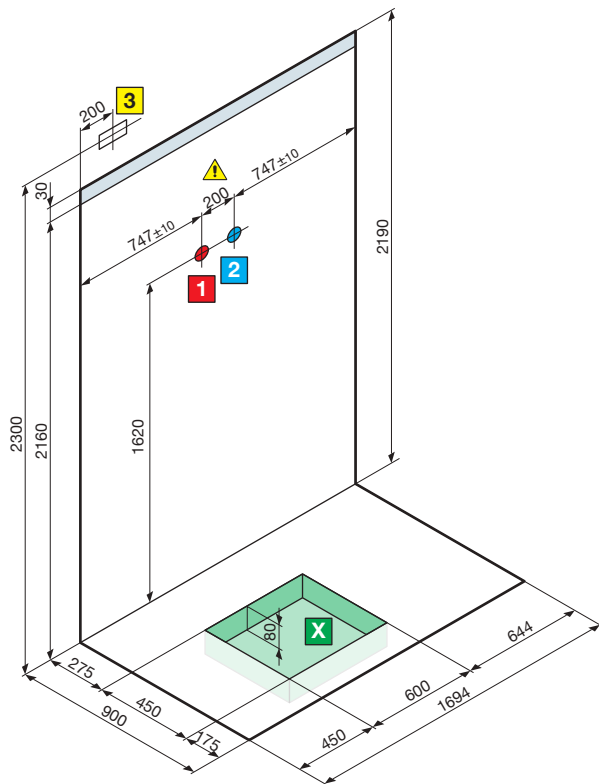

### HYDRAULIC CHARACTERISTIC:

Optimum dynamic pressure 2-5 bar  
 1/2" hot water connection  
 Cold water connection 1/2"  
 Siphon connection with  $\varnothing$  40 mm coupling

### ELECTRICAL CHARACTERISTIC:

Supply voltage 220-230 V  
 Frequency 50/60 Hz  
 Maximum absorbed power: 5100 W  
 Nominal power: 5000 W

**WARNING:** The whirlpool bath system must be fitted upstream with a 30 mA circuit breaker with a minimum contact of 3mm. **It could be dangerous for pacemaker wearer**

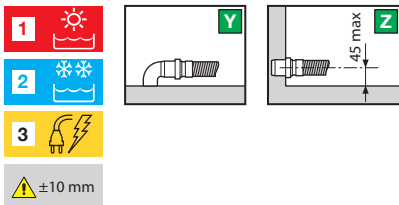
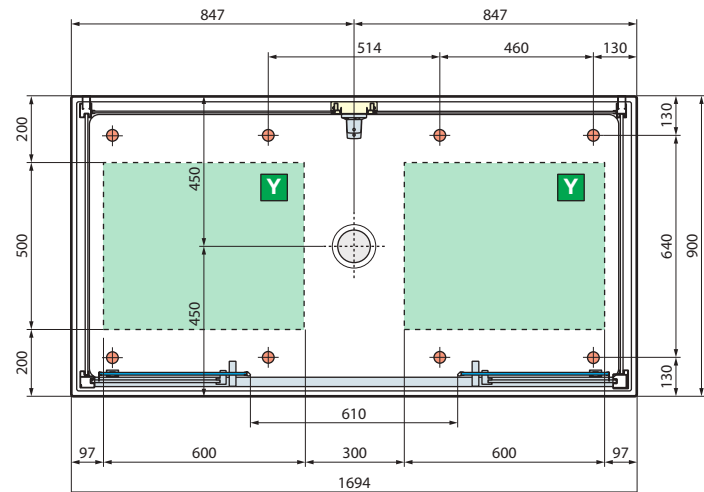
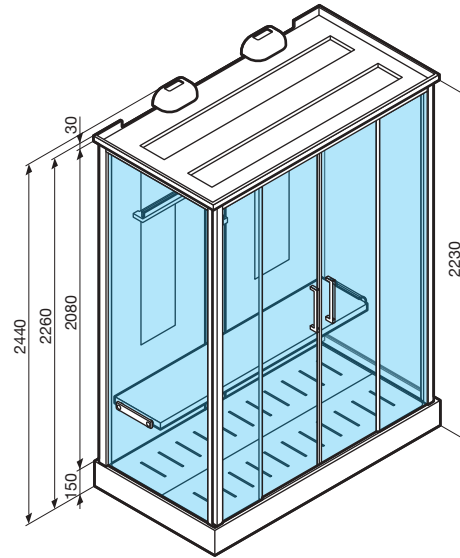
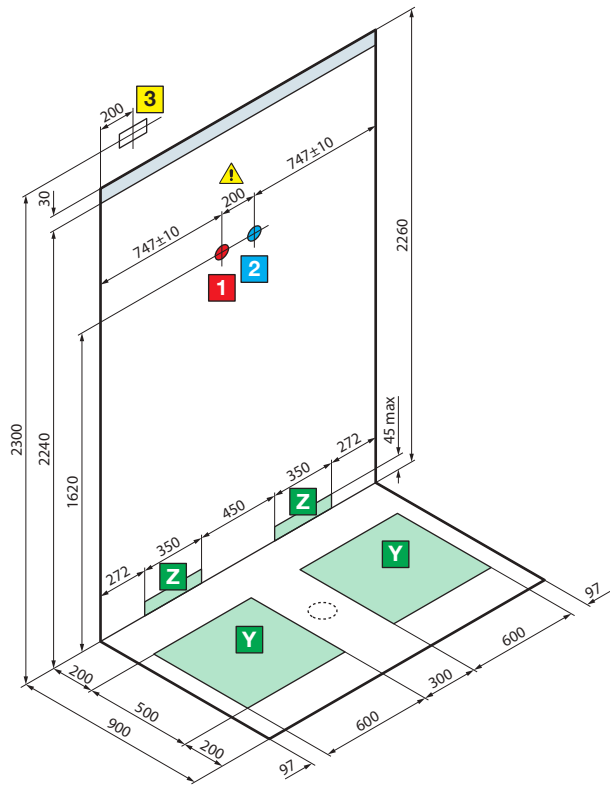

### HYDRAULIC CHARACTERISTIC:

Optimum dynamic pressure 2-5 bar  
 1/2" hot water connection  
 Cold water connection 1/2"  
 Siphon connection with  $\varnothing$  40 mm coupling

### ELECTRICAL CHARACTERISTIC:

Supply voltage 220-230 V  
 Frequency 50/60 Hz  
 Maximum absorbed power: 5100 W  
 Nominal power: 5000 W

**WARNING:** The whirlpool bath system must be fitted upstream with a 30 mA circuit breaker with a minimum contact of 3mm. **It could be dangerous for pacemaker wearer**

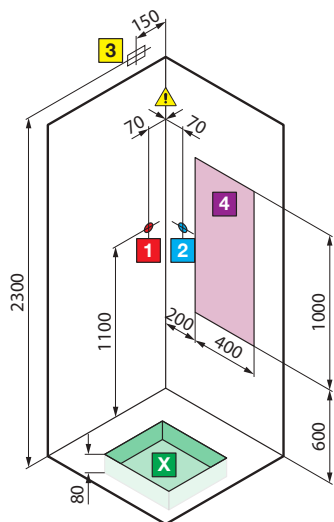
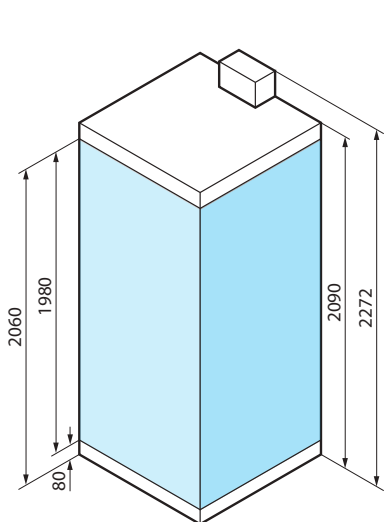

for models  
**A90 - R90**

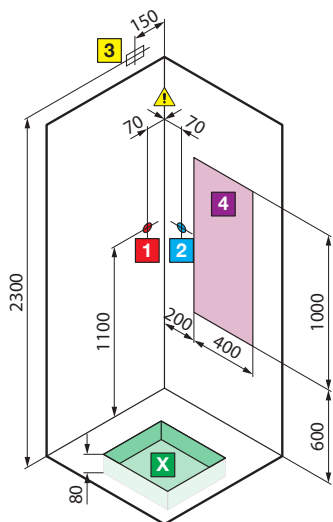

**left version**  
for models **A100x80 - A120x80**

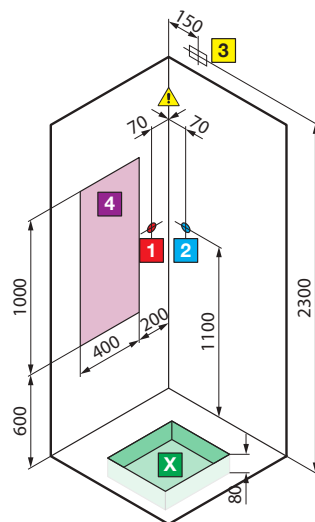

**right version**  
for models **A100x80 - A120x80**

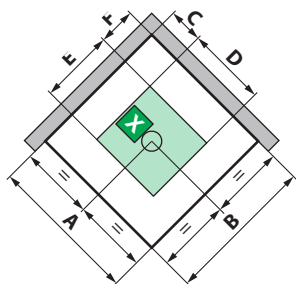

model	A ± 2	B ± 2	C	D	E	F
<b>A90</b>	900	900	150	500	450	275

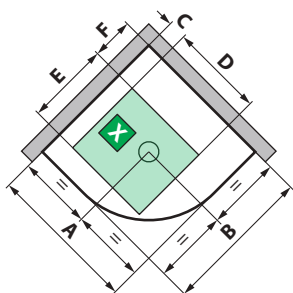

model	A ± 2	B ± 2	C	D	E	F
<b>R90</b>	900	900	150	500	450	275

**S** INSTALLATION ON THE LEFT

**D** INSTALLATION ON THE RIGHT

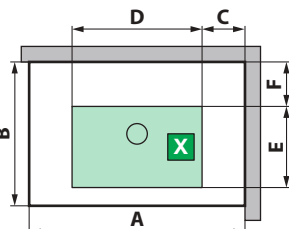
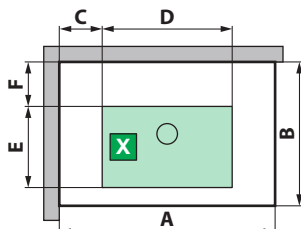

model	A ± 2	B ± 2	C	D	E	F
<b>A100x80</b>	1000	800	200	500	450	220
<b>A120x80</b>	1200	800	200	600	450	220

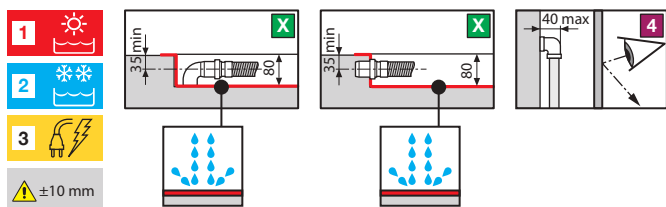

**HYDRAULIC CHARACTERISTIC:**

Optimum dynamic pressure 2-5 bar  
1/2" hot water connection  
Cold water connection 1/2"  
Siphon connection with ø 40 mm coupling

**ELECTRICAL CHARACTERISTIC:**

Supply voltage 220-230 V  
Frequency 50/60 Hz  
Maximum absorbed power: 2600 W  
Nominal power: 2500 W

**WARNING:** The whirlpool bath system must be fitted upstream with a 30 mA circuit breaker with a minimum contact of 3mm. **It could be dangerous for pacemaker wearer**

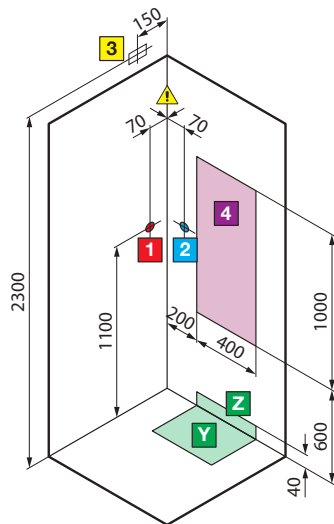
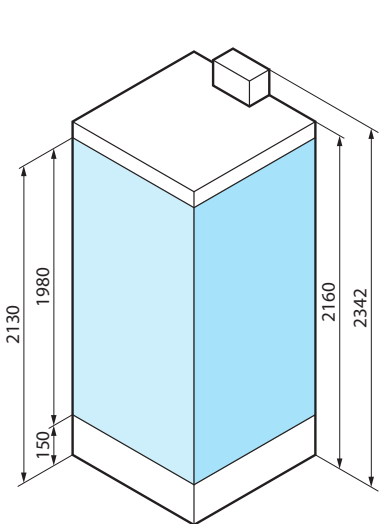

for models  
**A90 - R90**

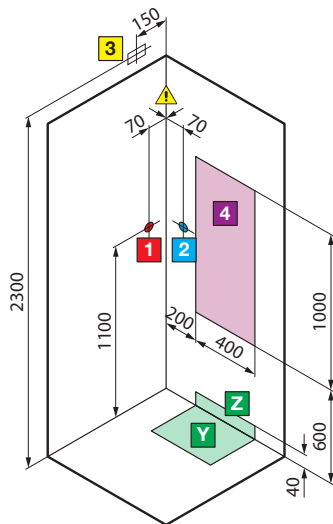

**left version**  
for models **A100x80 - A120x80**

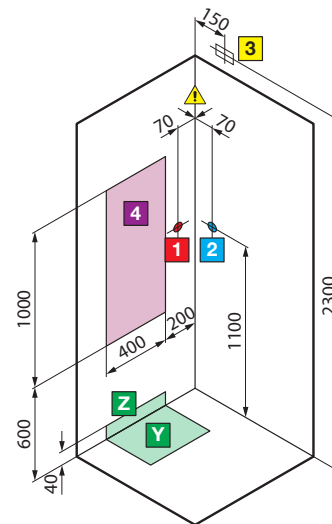

**right version**  
for models **A100x80 - A120x80**

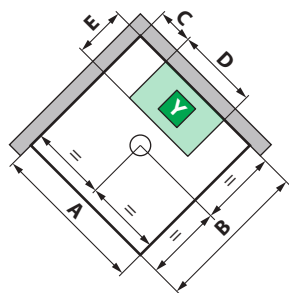

model	A ± 4	B ± 4	C	D	E
<b>A90</b>	900	900	200	500	300

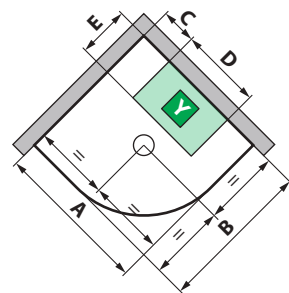

model	A ± 4	B ± 4	C	D	E
<b>R90</b>	900	900	200	500	300

**S** INSTALLATION ON THE LEFT

**D** INSTALLATION ON THE RIGHT

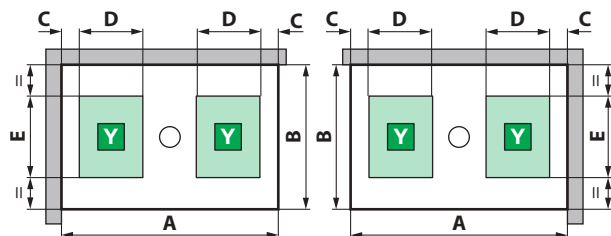

model	A ± 4	B ± 4	C	D	E
<b>A100x80</b>	1000	800	100	250	450
<b>A120x80</b>	1200	800	100	350	450

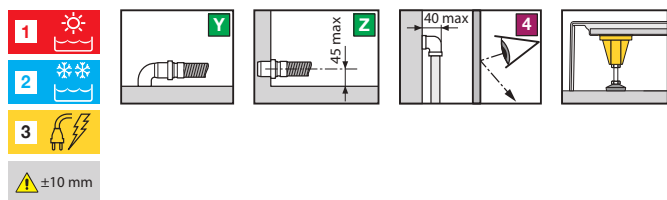

**HYDRAULIC CHARACTERISTIC:**  
 Optimum dynamic pressure 2-5 bar  
 1/2" hot water connection  
 Cold water connection 1/2"  
 Siphon connection with ø 40 mm coupling

**ELECTRICAL CHARACTERISTIC:**  
 Supply voltage 220-230 V  
 Frequency 50/60 Hz  
 Maximum absorbed power: 2600 W  
 Nominal power: 2500 W

**WARNING:** The whirlpool bath system must be fitted upstream with a 30 mA circuit breaker with a minimum contact of 3mm. **It could be dangerous for pacemaker wearer**



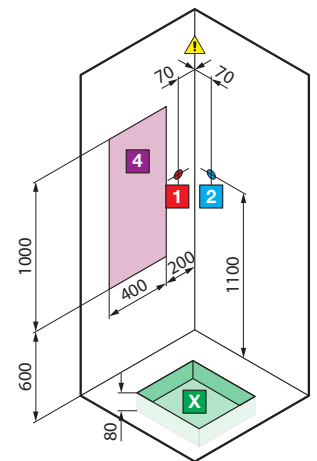
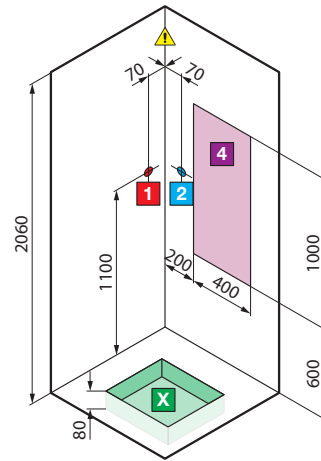
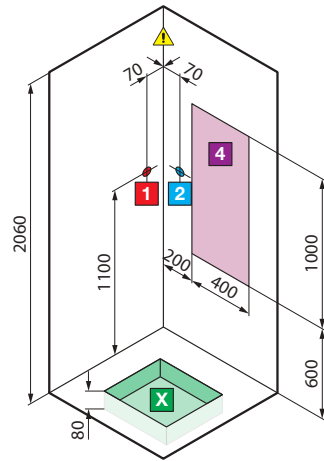
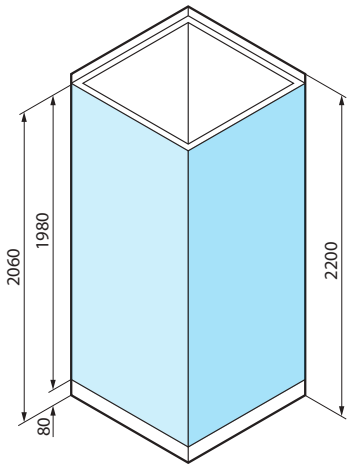

**corner version**

mod. **R90**

**left version**

**right version**

mod. **2P120x80**

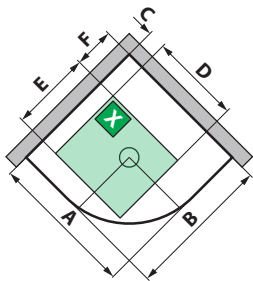

model	A ± 2	B ± 2	C	D	E	F
<b>R90</b>	900	900	150	500	450	275

**S** INSTALLATION ON THE LEFT

**D** INSTALLATION ON THE RIGHT

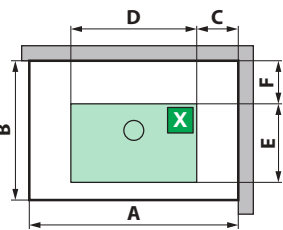
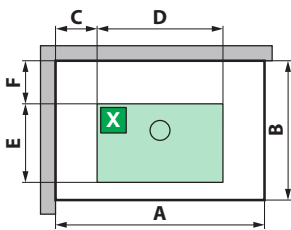

model	A ± 2	B ± 2	C	D	E	F
<b>2P120x80</b>	1200	800	200	600	450	220

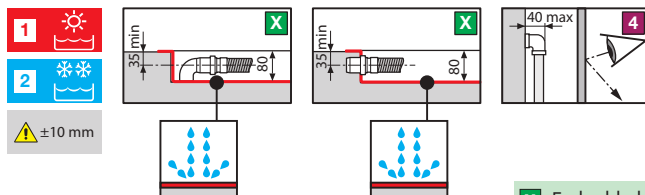

**X** Embedded in the floor area for unloading

**HYDRAULIC CHARACTERISTIC:**  
 Optimum dynamic pressure 2-5 bar  
 1/2" hot water connection  
 Cold water connection 1/2"  
 Siphon connection with ø 40 mm coupling

# CRYSTAL / CRISTALLO 2 shower tray 150 mm TECHNICAL DRAWINGS

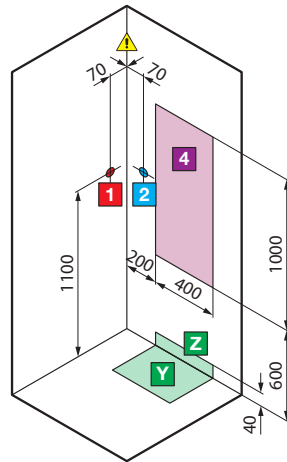
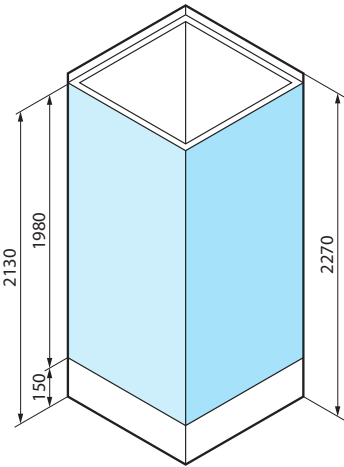

**corner version**  
mod. **A80 - A90 - G90 - R90**

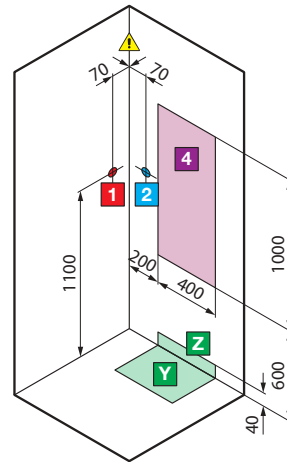

**left version**

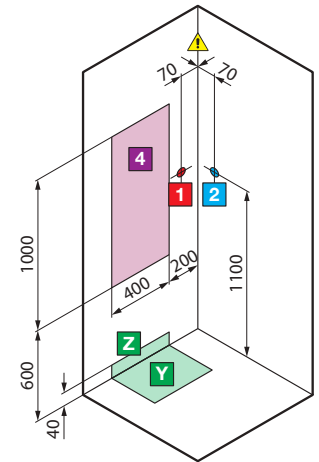

**right version**  
mod. **A90x70 - A100x70 - A100x80 - 2P120x80**

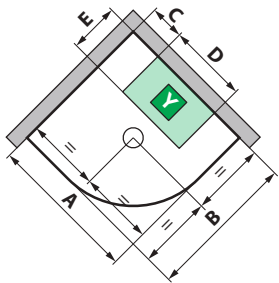

model	A ± 4	B ± 4	C	D	E
<b>R90</b>	900	900	200	500	300

**S** INSTALLATION ON THE LEFT    **D** INSTALLATION ON THE RIGHT

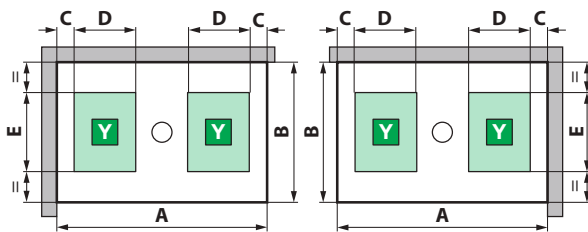

model	A ± 4	B ± 4	C	D	E
<b>2P120x80</b>	1200	800	100	350	450

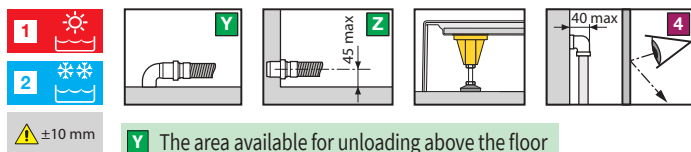

**HYDRAULIC CHARACTERISTIC:**  
Optimum dynamic pressure 2-5 bar  
1/2" hot water connection  
Cold water connection 1/2"  
Siphon connection with ø 40 mm coupling

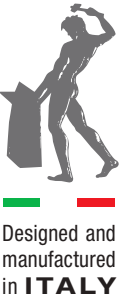

**Novellini UK Ltd**

Unit 11, Caxton Court - Porters Wood  
St Albans - Hertfordshire - AL3 6XT  
Tel: 01727-229922 - Fax: 01727-838232  
info-uk@novellini.com

**[www.novellini.co.uk](http://www.novellini.co.uk)**

