

FITTINGS AND ACCESSORIES



Art.-Nr.: 03507/020401 Katalog Armaturen und Accessoires, englisch, 08/16

FITTINGS AND ACCESSORIES 8-133

EDITION 400 8-27

EDITION 11 28-43

EDITION 300 44-53

ELEGANCE 54-65

PLAN 68-81

COLLECTION MOLL 82-95

IXMO 96-103

meTime_spa 104-111

ACCESSORIES 112-129

ASTOR 116-117

CITY.2 118-119

UNIVERSAL ARTICLES 120-127

COSMETIC MIRRORS 128-129

FITTINGS TECHNOLOGY 132-135

PRODUCT OVERVIEW 138-209

A FASCINATION FOR THE BATHROOM



Hartmut Dalheimer, Managing Director



Engelbert Himrich, Managing Partner



Sensuousness and sensibility – KEUCO’s passion for the bathroom runs through its veins, and this is evident in our products. A KEUCO bathroom awakens the emotions. It is an intimate place of well-being. It conveys elegance and luxury, and it combines aesthetics, ergonomics and functionality.

In no other room is this challenge more exciting and demanding than the bathroom. That is why this fascination still drives us forward. Since its founding in the year 1953, our company, which is still family-run today, has undergone a rapid and sustained transformation. From market leader for high quality bathroom accessories, KEUCO has evolved into the brand for the bathroom, with a wide assortment of furniture, fittings, accessories and mirror cabinets and from our early days we focused on offering concepts of complete bathroom furnishings.

Important factors contributing to our success are the contemporary, technically innovative products, the highest standard of quality, a clear orientation towards design, and state-of-the-art manufacturing facilities. Today, KEUCO products are sold around the world, and are market leaders in many areas. They are the result of intensive development work, the use of the best materials, and the most careful workmanship. We combine high-tech manufacturing and involved hand craftsmanship to achieve optimum results. KEUCO quality sets standards: Our products will convince you by their immaculate surfaces, maximum longevity, and perfect functionality. Each article is examined individually before being shipped out.

At KEUCO, the subject of design already played a pivotal role long before it even became a general topic of conversation. Our understanding of design involves striving to achieve classic-modern aesthetics that retain their contemporary feel, even after many years of use. Whether designed in-house or in cooperation with internationally recognized designers – KEUCO products are regularly distinguished by renowned awards.

But timeless design and long-lasting product quality are only two aspects of our sustainability philosophy. Equally important are responsible company management, and resource-saving production – with the help of our own water conditioning system for our electroplating plant, for example. We view the label “Made in Germany” as commitment to the kind of company management that aims to secure jobs in the long term.

KEUCO products are made in our own production plants in Hemer, Gütersloh and Bünde. Inland production provides us with a close proximity that is essential, so that we can develop and utilize the know-how of our employees on a long term basis, and so achieve seamless quality management. And that makes “Made in Germany” a promise of quality.



EDITION 400

OUR IDEA OF FREEDOM OF DESIGN



SENSUOUS SHAPES IN GLEAMING CHROME



A characteristic of EDITION 400 is its sensuously beautiful style. The gleaming chrome-plated fittings of the series present themselves like filigree sculptures. Virtually works of art, their extraordinary presence almost makes you forget their actual purpose. Conceived by the design agency Tesseraux+Partner in Potsdam and rewarded the "Design Plus" seal of quality, they are a prominent stylish element in KEUCO's full range of bathroom furnishings.



ELEGANCE MADE IN GERMANY



Perfection in detail is what makes EDITION 400 fittings especially stand out. The washbasin mixers in five sizes with discharge height of 80 mm to 290 mm for all types of washbasins prove this in excellent terms. The adjustable regulator, which cannot be seen from the outside, is a special feature that is integrated in the outlet. Moreover, EDITION 400 offers a range of different washbasin fittings, including a pillar tap, a single-lever mixer with a swivel spout, a wall fitting and a three-hole fitting.





The bath fittings in two different designs give you every reason to relax. In this case, again KEUCO has kept to what is essential – looking at both the four hole bath tub side fitting and the single-lever bath mixer. Ultimately, how you take a bath is a real question of personal taste.



DELICATE DESIGN ACCESSORIES

An aesthetic of filigree design, special functional features in the details, and high quality – this is how EDITION 400 accessories set special accents and create a sensuous atmosphere in the bathroom. With their practical functionality and elegantly slender appearance they pamper the user.

Harmoniously coordinated in design are also the lotion dispenser and tumbler holder – two perfectly matching companions. Combined with a utensil shelf, the accessories add homely comfort to the bathroom.



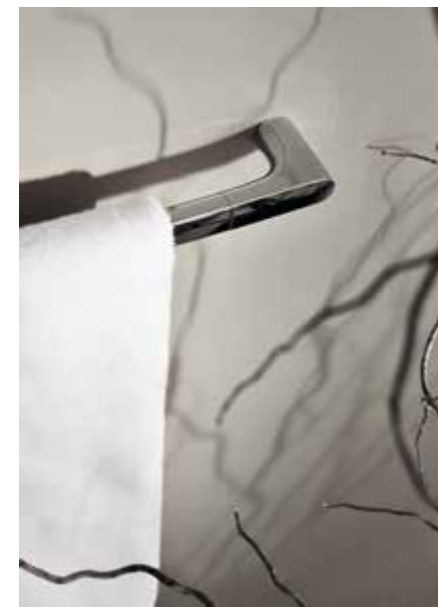

The variety of the products EDITION 400 offers an abundant selection of accessories for a sophisticated bathroom design. The hook segment alone ranges from a double towel hook to single towel hook. One special detail of the double towel hook is that the towel is hung up from the back – so the design is not hidden even when in use.



For an EDITION 400 bathroom with style and a feel-good ambience, the intelligent functionality of the accessories is the icing on the cake.

The shower shelf is made from high quality aluminium and is therefore especially resistant and stable. The shower shelf has the excellent feature of a "docking station" for the glass squeegee, which is not immediately apparent at a first glance. Harmoniously integrated into the design, it prevents shower articles from falling down.



Also around the toilet area, the EDITION 400 accessories are harmoniously integrated into the architectural environment of the bathroom design. With its particularly delicate design, the toilet paper holder demonstrates that it has the potential to become the next new classic. It is swivel-mounted, extremely delicate and can be easily attached to the wall. Even the wall-mounted toilet brush set impresses with its little secrets: On the outside it presents itself in fine, satin glass; inside it has a practical removable holder. The toilet brush hangs hygienically inside and it is concealed behind a lid.





FREEDOM IS
HAVING A VARIETY
OF POSSIBILITIES



PURE DESIGN – BUT NOT PURITANICAL

The renowned design agency Tesseraux+Partner was commissioned to design EDITION 11. At first glance and at every use the fittings and accessories convey a feeling of: Here is where perfect quality can be found.

The immaculate, hand-polished surfaces, the most careful of workmanship, the most modern of technology, corrosion-free fasteners, and the meticulous checks for leak-proof results on each individual fitting: Only this way a quality grade can be achieved at a level that one can see, appreciate, and which constantly pays off.



Tesseraux+Partner
Dominik Tesseraux

CLEAR LINES, IMMACULATE SURFACES

The perfect chrome-plated washbasin fittings of EDITION 11 are optimally suited for every kind of use. Whether as a smaller model for the guest WC or especially high for washbasin tops and convenient hair-washing – they fulfil any wish regarding individual bathroom planning.





As with all EDITION 11 washbasin fittings, the wall fitting with single-lever mixer has a flow rate limiter. It is available with three different length spouts.



Three-hole fittings with a difference: Temperature regulation on the left, flow rate on the right. After adjusting to your own desired temperature, by pulling it up, the regulator can be returned to its initial position so that the temperature setting is retained.



The particularly appealing design of the freestanding bath tub mixer with a separate waterway for the hand shower is very impressive. A gem in the bathroom, it can be combined with numerous bath tubs and, no matter what one's personal interior design is, gives every bathroom a special touch.



Shower rail and hand shower reiterate the weightless elegance of the design of EDITION 11. In the four-hole bath-edge fitting with hand held pencil shower head the basic quadratic form of EDITION 11 is reflected in the decor disc. The bath tub mixer shines in immaculate chrome lustre, with flow and temperature regulators situated on the side.



SELECTED SHAPES IN EVERY DETAIL



KEUCO's typically large variety of products offers a rich selection for attractive bathroom furnishing. For hanging up towels alone, the assortment ranges from classic double towel holders to chic one-armed towel holders and vertical guest towel holders (along with towel bins) which can hold up to six guest towels. The product range also includes an intelligent towel ring, which has an integrated spacer ensuring that damp towels can dry properly at a sufficiently ventilated distance away from the wall.





The chrome-plated shower basket comes optionally with a conveniently integrated glass squeegee. It is easy to clean, and offers generous space for soaps, shampoos, and similar. Because of its rounded form on the inner surface, the handle, with its concisely crafted edges, has an especially pleasant feel to it.



On the right: Soap holder with removable glass dish and the double tumbler holder with mouth-blown tumblers made of crystal glass.



CLEAR LINES AND SENSUAL FEELING

The freestanding accessories of EDITION 11 radiate power and size and embody sense and sensuality with their high-quality matte porcelain. The unglazed porcelain is individually produced in a complex and meticulous process in Meissen. In total there are four porcelain accessories to choose from. They exert their special appeal in the bathroom when combined together: A soap foam dispenser, a universal pot, a tissue dispenser and an elegant dish.



EDITION 300

CHARACTER INSTEAD OF INDIFFERENCE



A STRIKING, ERGONOMICALLY THOUGHT-THROUGH DESIGN



KEUCO design is determined by aesthetics, functionality and ergonomics, not by the kind of logic that characterizes mass production. The fittings and accessories of EDITION 300 clearly exemplify this philosophy and make it something to be experienced. Convenience of use coupled with striking elegance. The brilliance of the perfectly worked surface emphasizes the characteristic contours.



reddot design award
winner 2006

Tesseraux+Partner
Dominik Tesseraux



LASTING IMPRESSIONS FOR SHORT STAYS



The guest WC is a special calling card in every house. With its impressive functionality and stylish elegance, EDITION 300 is ideally equipped to leave an excellent impression with your guests. With the small, only slightly projecting washbasin size it's possible to design even guest WCs with much charm. Even the towel holder and the vanity unit with front drawer and integrated towel opening offer much comfort for small rooms.

CONSISTENT COMBINATION MADE EASY



At KEUCO accessories are much more than just useful additions. It is also important that they can be blended in any combination to form a harmonious visual whole, perfectly coordinated to the characteristic design of the rest of the bathroom furnishings. EDITION 300 does this beautifully.



ELEGANCE

VARIETY AS A PRINCIPLE



THE DESIGN CLASSIC WITH PROFILE

Initially begun in 1967 purely as line of accessories, ELEGANCE established itself internationally over the decades and became the biggest selling bathroom series in the world. Today, ELEGANCE offers a comprehensive assortment with a wide array of models. The demand for ELEGANCE products still remains steady today thanks among other things to its timelessly modern design.



.molldesign
Reiner Moll



EFFUSIVE FLEXIBILITY



Right angles and straight lines, coupled with vibrant curves. As in the entire collection, ELEGANCE fittings convince by their striking, classic-modern design.





HIGHLIGHTS



ELEGANCE accessories bring aesthetics, ergonomics and ease of cleaning under one umbrella. All metal parts are chrome-plated to a high standard of quality. The soap foam dispenser is made of matt opal glass; the lotion dispenser and the toothbrush tumbler are made of matt crystal glass. The matt crystal dish can be removed for cleaning from the soap dish on the right.





The ELEGANCE rail system brings elegant comfort into the bathroom: The rail system can be combined as needed with the existing bathroom furnishings.

The matching shower curtains from KEUCO are anti-bacterial, fungicidal, antistatic and available in different colours and sizes.





PLAN

CONSISTENCY
IN ITS MOST
BEAUTIFUL FORM



TIMELESSLY MODERN AND INCREDIBLY VERSATILE



With 450 individual products, PLAN is one of the most extensive bathroom collections in the world. PLAN is as varied as the lifestyles of today and the breadth and depth of its large assortment enables individual, tailored solutions to be found. PLAN leaves nothing to be desired – not from an aesthetic or an ergonomic point of view, as the main focus of the PLAN care range offers an additional wide collection of barrier-free products to choose from.



DESIGN PLUS



reddot design award
winner 2006

.moll
Reiner Moll

PERFECTLY COMBINED – DESIGN AND QUALITY

The fittings are as pleasant to use as is the purity of their forms. Whether chrome-plated, stainless steel, or with aluminium finish: The excellent design and the unmatched quality of PLAN fittings manifest themselves in each individual piece. And fully thought-through design sometimes demonstrates itself in a very discreet way: In the extreme ease of cleaning, for example.





PLAN blue fittings not only shine in terms of their impeccable surfaces and uncompromising functionality, but also with a consistently implemented sustainability concept. PLAN blue fittings help save water and energy in daily use; one example is the flow limiter in the washbasin mixer which limits to six litres per minute.

Thus, the new PLAN blue mixer with pivoting spout is not only a perfect solution for private use, but also for public areas. As a single lever mixer or pillar tap, they stand out in the slim design thanks to their precise design style and low water consumption.

EYECATCHER IN EVERY BATHROOM



The wide range of surface variants multiplies the diversity of PLAN even more. Choose from chrome-plated, aluminium and stainless steel. Or between lotion dispensers as free-standing model (left) and the mounted model (top), suitable for installation in the washbasin or washtop.

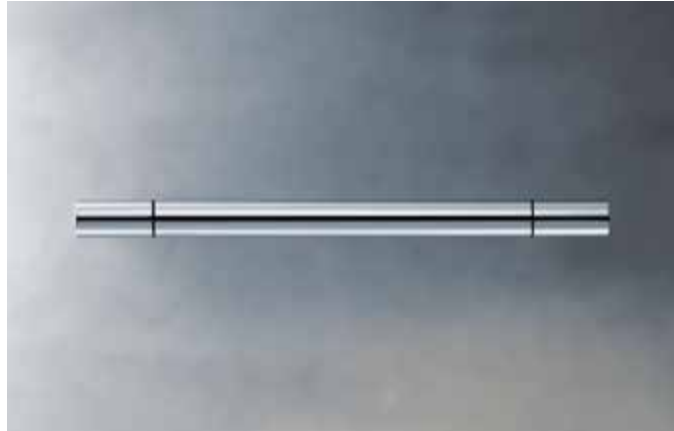

Innovative, elegant and of uncompromising quality: PLAN accessories stand out aesthetically as well as functionally. On this page: Grab rail, towel holder and towel hooks. The flawless surface of the toilet paper holder on the right delights users.

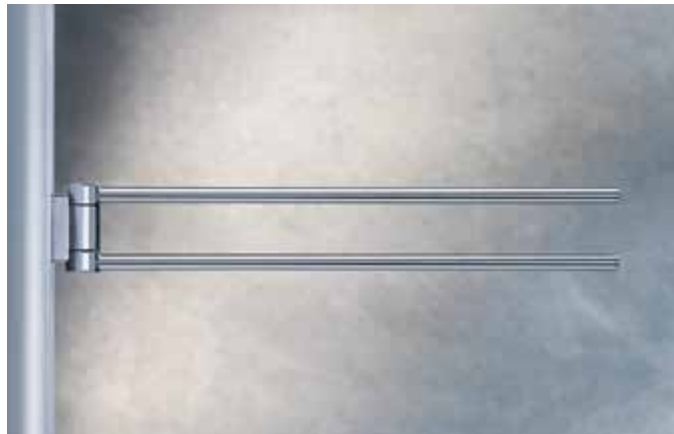

HIGH QUALITY, CONVENIENT, BEAUTIFUL



The CARE products on this page can be flexibly combined for sanitation facilities. The PLAN railing system enables, among other things, a shower to be made barrier-free in a jiffy, if need be, thanks to the attachable tip-up seat. The firmly mounted soft seat, 450 mm wide – also available in 360 mm width – meets the requirements of DIN 18040-1.

COLLECTION MOLL

NEW TIMELESSNESS



INSPIRATION AND INNOVATION

The COLLECTION MOLL lets fittings and accessories shine in a new light: An inspiring design, highest innovative details and needless to say, the complete KEUCO competency for precise workmanship and durable quality. The unobtrusive, sleek design gives the collection a lightless and timeless beauty that bears the signature of the designer Reiner Moll, and harmonises with numerous KEUCO washbasin and furniture ranges.



.molldesign
Reiner Moll



FREEDOM LIES IN THE VARIETY

The product diversification of the COLLECTION MOLL is also reflected by the range of fittings. The diverse variety makes sure to find a tailor-made solution for any imaginable constellation. They impress both through their high level of "Made in Germany" quality as well as through their attractive design. The exceptionally high quality level of material and workmanship make the products a sustainable investment. In addition to durable technology and a design style that can be combined in different ways, the on-wall fittings are also characterized by functional elements. They therefore offer useful storage space for bathing and showering utensils near the bath tub or in a shower.

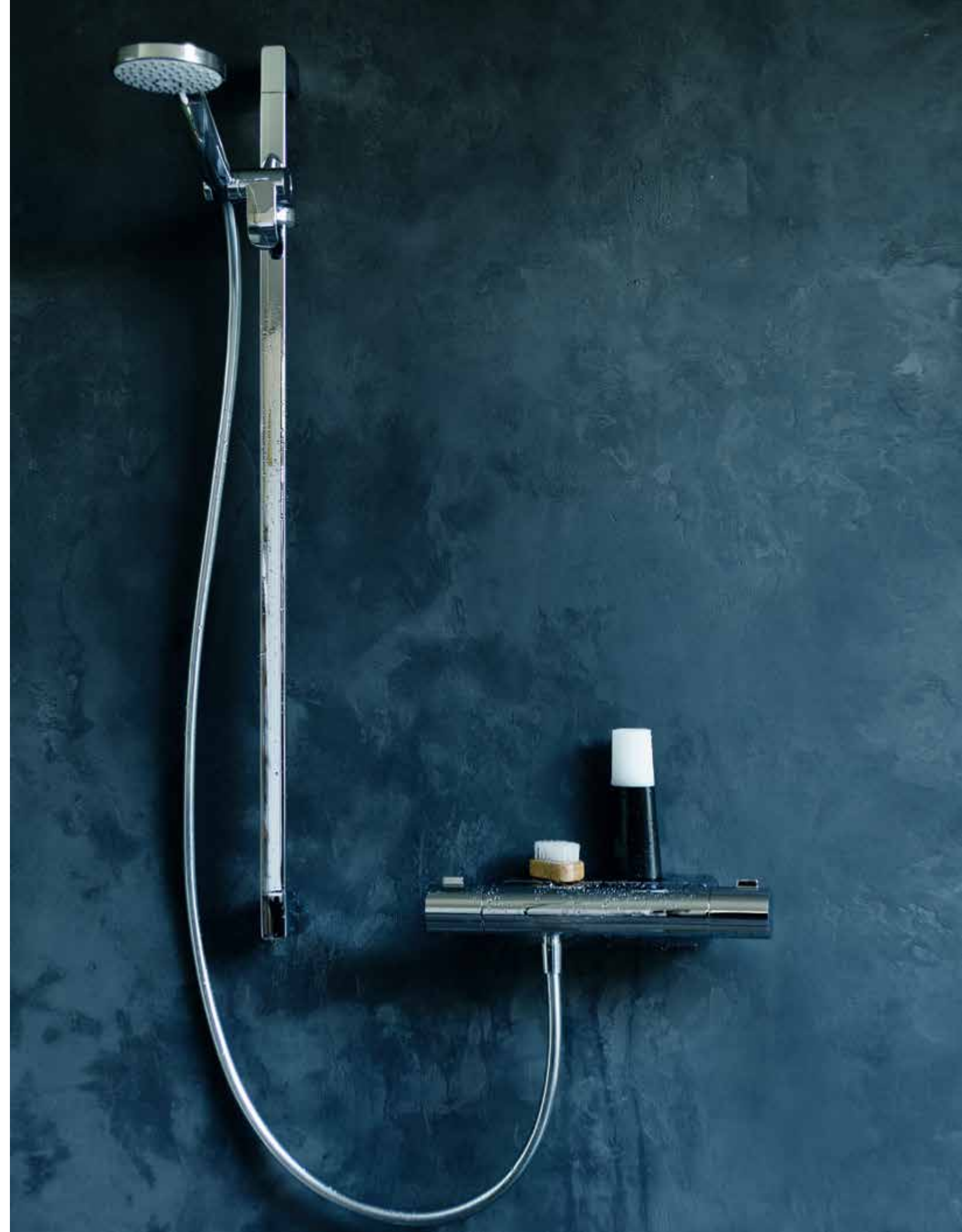

IDEAS RIGHT DOWN TO THE LAST DETAIL



Whether for corners or walls, the shower baskets of COLLECTION MOLL have a removable, break-proof synthetic insert – hygienic and easy to clean.

The sponge basket, with its integrated, retractable shower squeegee, demonstrates what aesthetically technical innovations could look like. After use, the shower squeegee disappears into the sponge basket, which is open at the bottom so water can drain away.





A brilliant chrome finish and solid materiality make the high quality of the fittings and accessories eminently tangible. In addition to the real crystal soap dish and tumbler, the lotion dispenser made of matt glimmering synthetic material – available in white or anthracite – captivates with its ease of care.



One can hang up, hang up or hang up a towel: From a towel ring and double hook, via a single or double-armed towel holder. The COLLECTION MOLL offers a generous collection for an attractive bathroom design style. The towel ring, for example, is made entirely in one piece and its seamless aesthetic stands out. The ergonomically designed towel rail invites to be touched.





Maximum functionality and attention to detail are also special features of COLLECTION MOLL products for the WC – from the toilet paper holder with or without lid, right to the WC brush set, as a wall or floor model: For example, the toilet brush set, in which the brush hangs in the brush holder and therefore avoids looking directly at the brush.

LESS IS MORE



IXMO

COMPRESSED FUNCTIONS: 3 BECOME 1



The central concept behind the IXMO fittings for the shower is the concentration of functionality. An IXMO single-lever mixer or thermostat is always combined with multifunctional IXMO elements which, in addition to connections for one, two or three water channels, also compactly unite other functions such as a hose connection, hand shower bracket, stop cock, or selector. This allows the number of products on the wall to be reduced, and enhances the appearance at the same time. Since the individual fitting units can be freely positioned, IXMO offers a high standard of design freedom.

With the IXMO fittings for the shower, KEUCO once again demonstrates its high standard of innovation in design and technology.





At the centre of the IXMO fitting is a single-lever mixer or thermostat which can be combined with multifunctional fitting elements in a coordinated design. The single-lever mixer for the shower is available with its own handle, but it is also available in other design variations to match all KEUCO fittings series.



A QUESTION OF COMBINATION



Another special advantage of IXMO fittings can be found in the wall itself. Here, the fittings system scores points with intelligent innovations: At a variable installation depth of 80 to 110 mm the single-lever mixer and thermostat feature an intelligent depth offset, which always ensures that the fitting elements project out from the wall in an equal appearance as the fine construction set adapts to the basic construction set. Overall a new fusion of design and functionality for the future.

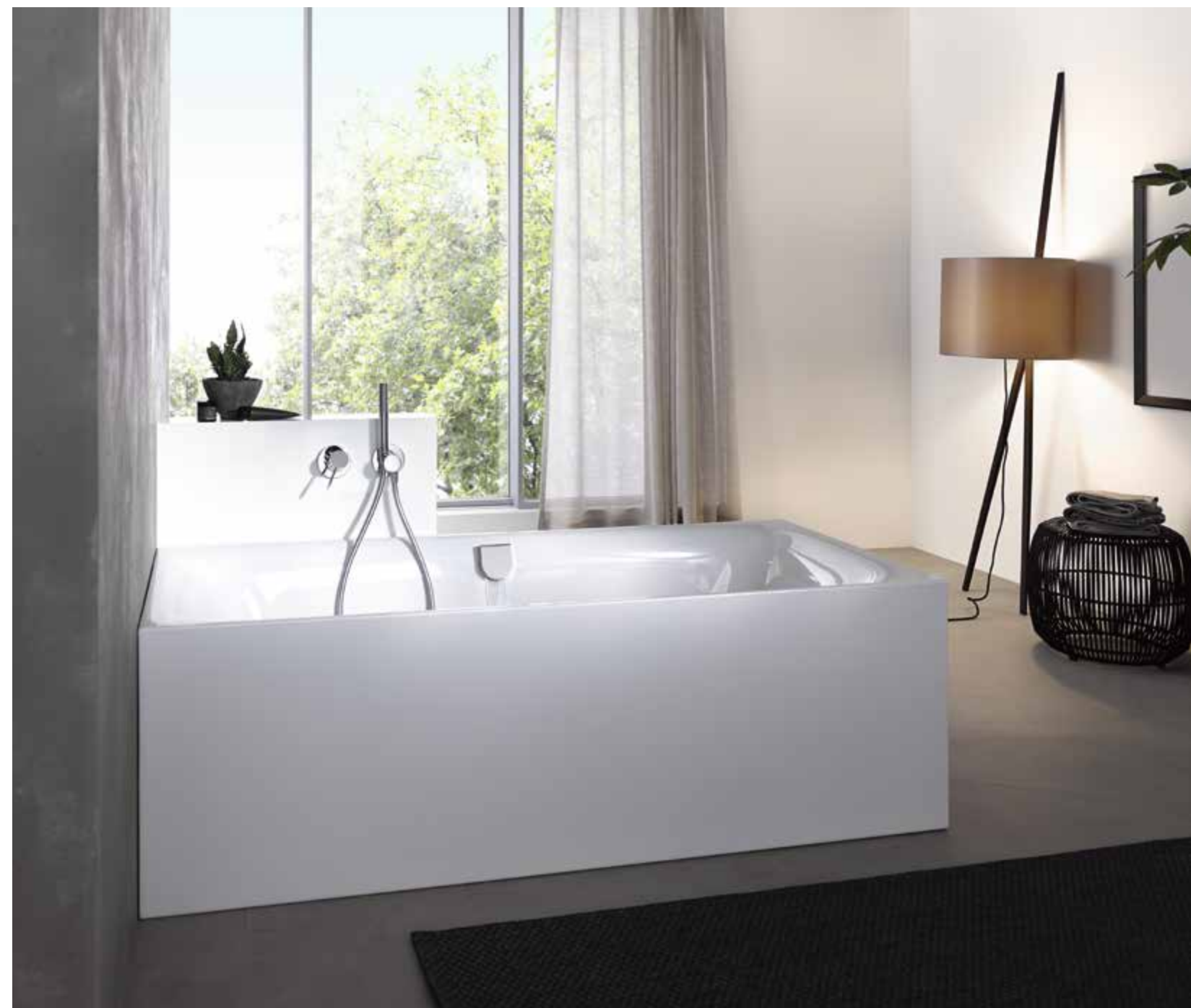

SHOWER EXPERIENCE FOR THE SENSES





Comfort and sensuality are at the forefront of this very special solution for shower fittings. The multi-functional concealed thermostat meTime_spa unites everything which one needs for an extraordinary shower experience – not only in an elegant but also innovative way.

The fitting comes in various sizes and, besides chrome-plated control elements to adjust the flow and temperature of the water, it also offers aluminium shelving on one or more levels. So that it integrates into your own personal interior design style in the best possible way, the glass panel is available in white, anthracite, petrol, truffle or cashmere.



Tesseraux+Partner
Dominik Tesseraux



WATER IN ITS HEALTHIEST FORM



The element of water has always fascinated people. It is particularly fascinating when it takes the form of a waterfall. The aesthetic meTime_spa dousing shower can bring this experience into your own bathroom. The feeling of taking a shower under a waterfall – of allowing the primal power of water act on you – is relaxing for your mind and soul, too. The water treatments inspired by Sebastian Kneipp are perfect for allowing the soothing and relaying effects of water fall on your skin and muscles. With the SPA hose, you can experience the health-promoting alternating hot and cold showers in the privacy of your own bathroom at home and at your leisure.

LITTLE HELPERS WITH A BIG IMPACT



QUALITY AND DESIGN FOR HIGH PERFORMANCE

High-quality materials, excellent workmanship and perfect surfaces – these are the common denominators of all KEUCO accessories. They allow you to perpetuate and effectively accentuate your own personal style of aesthetics in your home. Thanks to their large variety, KEUCO accessories offer the right solution for every kind of bathroom.





Elegance in circular and spherical shapes: With their decorative discs, ASTOR accessories provide an aristocratic flair in the bathroom. On the right the chrome-plated towel ring. Top: Lotion dispenser made of matt opal glass, tumbler holder with crystal glass tumbler, soap holder with crystal dish, and toilet paper holder with lid.





Urban chic, not just for town houses: CITY.2 adds objective elegance to the bathroom. Thanks to the enormous variety of products the series can satisfy the widest range of demands. Lotion dispenser on the left, on this page a soap dish and towel ring.



The whole universe of accessories: Our universal articles leave no wish unfulfilled because they offer the proper solution for every need. They are just as suitable for the private area as they are for public areas. Thanks to their practical and functional design and the different variations, they blend harmoniously into every bathroom.

Strong performance: A grab bar with integrated soap dish. Top, moist tissue box, tissue box, and a tip-up seat for maximum comfort while in the bathroom.



Practical, high quality and compatible with any style – discover the diversity of KEUCO's universal articles: Whether toilet paper double holder (right), soap foam dispenser as free-standing model (large picture) or the free-standing models for the WC. The brilliant chrome surfaces of the brush holders and their solid material mean that you can really feel the quality of the workmanship. The solid base with anti-slip mat ensures that it is stable.





Durable, easy-to-clean – and simply beautiful. The huge variety of KEUCO accessory designs carries on with the soap wire baskets. The different shapes, surfaces, dimensions and variants for corner or wall mounting offer the right solution for every hotel bathroom – including practical details such as an integrated glass squeegee (right bottom), which can be easily taken out from the front.





Sometimes simply functional, sometimes full of useful surprises as can be seen on the right with an integrated glass squeegee: KEUCO soap and sponge baskets enchant with their wealth of variants.



BEAUTY MEETS INNOVATION



As a practical utensil for daily beauty care, the glare-free iLook_move cosmetic mirror shines with its slender, refined design in round or square form, with illuminated or unilluminated mirror surface. The hinge technology works brilliantly too: The height, distance, inclination and lateral angle can each be adjusted with a simple action. In the illuminated model with control panel on the glass surface, this innovative mirror with fivefold magnification designed by Tesseraux+Partner offers two different light modes: A daylight function, like the ones that can be found in professional beauty institutes, and a second luminous colour in flattering warm white – ideal for the perfect evening makeup, for example. Unique to date is the infinitely variable adjustment feature of both luminous colours.

Whether with a luminous colour or a control panel on the glass surface with sensor system, the iLook_move is simultaneously high tech for beauty care and a perfect masterpiece. The LED lamp is long-lasting and has minimal power consumption. If flush-mounted fitting is not an option, a version is also available with a wall wart. More detailed information about the iLook_move cosmetic mirror can be found in our catalogue "Mirror cabinets, light mirrors and cosmetic mirrors".





COMPLETELY
INNOVATIVE



FLEXIBLE PLACING

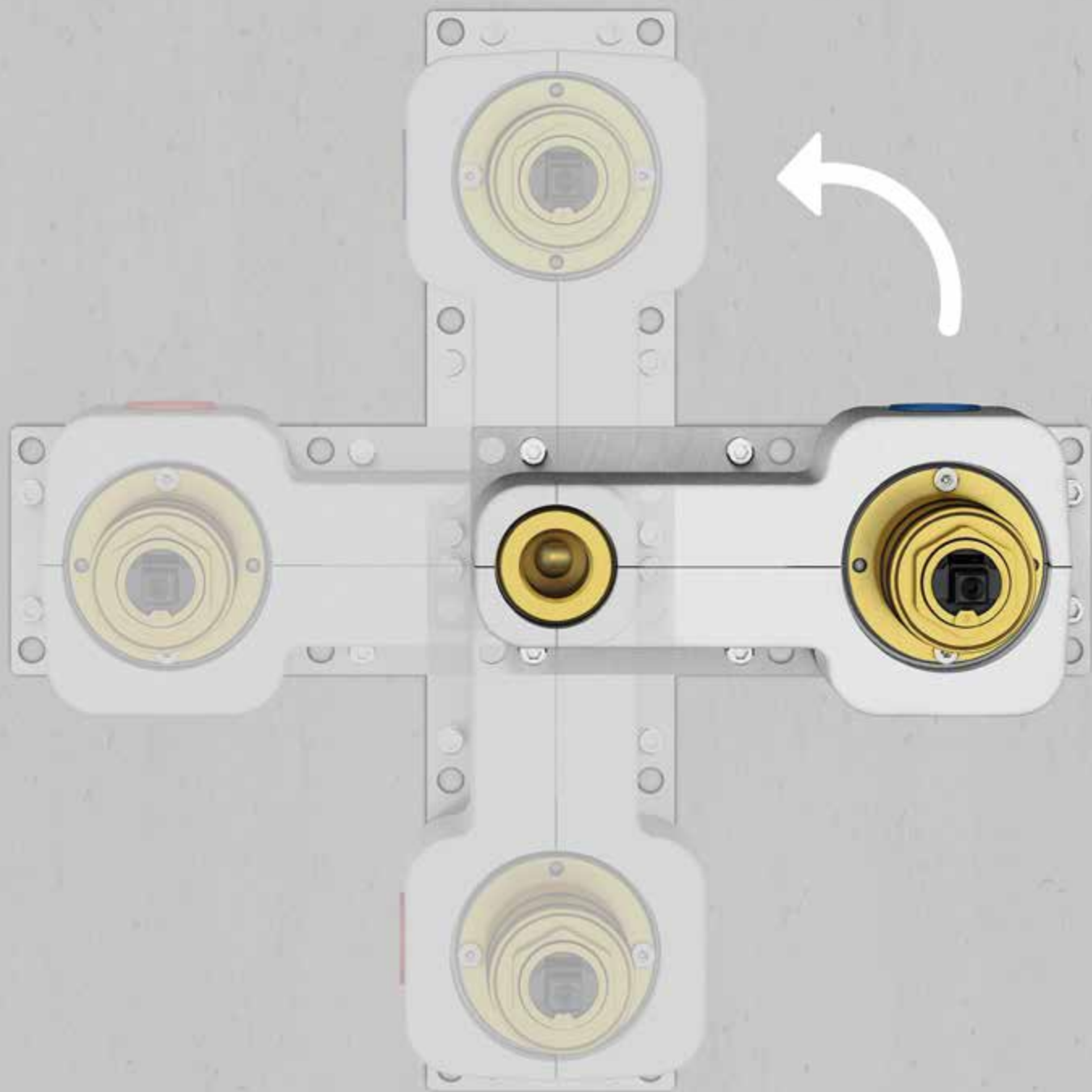

For wall fittings at double washbasins or for right and left-handed people, the position of the single-lever mixer makes a difference – either for the sake of symmetrical appearance or for the purpose of user-friendliness. Usually a different type of in-wall unit needs to be planned depending on the position of the lever in relation to the wall spout – to the right, the left, above or below. With a new technical innovation from KEUCO this question asked during the early planning phase is a thing of the past. This is because KEUCO has now developed an in-wall unit that can be used flexibly for all different arrangements of wall fittings at the washbasin.

One for all: The concealed installation unit from KEUCO offers the possibility of choosing the position of the handle around the wall spout of the washbasin fitting at short notice prior to installation on location. The cartridge fixture can be rotated in the in-wall unit before installation in only a few simple steps. And that's all it takes to individually adjust the position of the lever around the wall spout. There isn't a simpler way of planning washbasins with wall fittings.





WE'RE PASSIONATE
ABOUT FLAWLESS
PRODUCTS



PRODUCT OVERVIEW



51508



51504



51504



51502



51502



51502



51505



51509



51515

51508
Pillar tap 80
 without pop-up waste,
 1-hole installation, lever head action 90°
 with ceramic sealing gaskets,
 aerator SLIM SSR M 24x1, adjustable flow angle,
 flow rate limited to 7,6 l/min.

51502
Single lever basin mixer 150
 with/without pop-up waste 1 1/4 Inch,
 1-hole installation, cartridge mixer
 with ceramic sealing gaskets,
 aerator SLIM SSR M 24x1,
 adjustable flow angle,
 flow rate limited to 7,6 l/min.

51505
Single lever basin mixer 150
 with/without pop-up waste 1 1/4 Inch,
 spout swivelling +/- 45°,
 1-hole installation, cartridge mixer
 with ceramic sealing gaskets,
 aerator SLIM SSR M 24x1, adjustable flow angle,
 flow rate limited to 7,6 l/min.

51504
Single lever basin mixer 80
 with/without pop-up waste 1 1/4 Inch,
 1-hole installation, cartridge mixer
 with ceramic sealing gaskets,
 aerator SLIM SSR M 24x1, adjustable flow angle,
 flow rate limited to 7,6 l/min.

51502
Single lever basin mixer 240
 with/without pop-up waste 1 1/4 Inch,
 1-hole installation, cartridge mixer
 with ceramic sealing gaskets,
 aerator SLIM SSR M 24x1,
 adjustable flow angle,
 flow rate limited to 7,6 l/min.

51509
Single lever bidet mixer
 with pop-up waste 1 1/4 Inch,
 1-hole installation, cartridge mixer
 with ceramic sealing gaskets,
 aerator cache TT M 18,5x1
 flow rate limited to 7,6 l/min.

51504
Single lever basin mixer 120
 with/without pop-up waste 1 1/4 Inch,
 1-hole installation, cartridge mixer
 with ceramic sealing gaskets,
 aerator SLIM SSR M 24x1, adjustable flow angle,
 flow rate limited to 7,6 l/min.

51502
Single lever basin mixer 290
 without pop-up waste,
 1-hole installation, cartridge mixer
 with ceramic sealing gaskets,
 aerator SLIM SSR M 24x1,
 adjustable flow angle,
 flow rate limited to 7,6 l/min.

51515
Three-hole basin mixer 150
 with/without pop-up waste 1 1/4 Inch,
 3-hole installation, ceramic valve for temperature
 regulation and valve for flow control,
 aerator SLIM SSR M 24x1, adjustable flow angle,
 flow rate limited to 7,6 l/min.



51516



51520



51524



51530



51530



51545

51516
Single lever basin mixer
 concealed fitting DN 15,
 cartridge mixer with ceramic sealing gaskets
 and temperature control,
 aerator SLIM SSR M 24x1, adjustable flow angle,
 flow rate limited to 7,6 l/min.
 Projection: 187, 219, 265 mm
 (essential for installation:
 Rough part Article No. 59916
 to be ordered separately)

Note:
 flexible arrangement of lever and spout possible
 during assembly.

51530
Bath tub mixer
 4-hole bath filler,
 ceramic valve for temperature regulation
 and valve for flow control,
 aerator SLIM SSR M 24x1, adjustable flow angle,
 pull-out pencil hand shower,
 with backflow preventer
 Projection: 180, 220 mm
 (suitable fixing block Article No. 51130
 to be ordered separately)

51520
Single lever bath tub mixer
 exposed,
 cartridge mixer with ceramic sealing gaskets,
 with automatic diverter, aerator SLIM SSR M 24x1,
 adjustable flow angle, with backflow preventer

51530
Bath tub mixer
 3-hole bath filler,
 ceramic valve for temperature regulation
 and valve for flow control,
 pull-out pencil hand shower,
 with backflow preventer,
 (suitable fixing block Article No. 51130
 to be ordered separately)

51524
Single lever shower mixer
 exposed,
 cartridge mixer with ceramic sealing gaskets,
 with backflow preventer

51545
Bath spout DN 20
 suitable for all concealed fittings
 Projection: 152, 202 mm



51571



51572



51572



51573



51574



51580



56080



54947



54995



51585



51587



51591



51686/51688



51686/51689

51571
Single lever shower mixer
 concealed fitting,
 set complete with: handle, sleeve, rosette
 and installation unit,
 suitable for rough part no. 59970 (Flexx Boxx)
 (Flexx Boxx to be ordered separately)

51580
Hand shower
 with anti limescale device,
 with normal, soft and massage jet
 with ECO AIR function,
 restricted flow rate 10 l/min.

56080
Round pencil hand shower
 with normal jet

54947
Wall outlet for shower hose DN 15
 suitable for all concealed fittings

54995
Shower hose DN 15
 both ends fitted with conical nut
 and twist-protection
 1250, 1600, 2000 mm

51572
Single lever bath tub and shower mixer
 concealed fitting,
 with/without safety device,
 set complete with: handle, sleeve, diverter, rosette
 and installation unit,
 suitable for rough part no. 59970 (Flexx Boxx)
 (Flexx Boxx to be ordered separately)

51585
Hand shower sliding rail
 consisting of:
 – wall rail, 900 mm
 – sliding bracket for hand shower
 – height adjustment via handle,
 tilting angle adjustable
 – spacer disc (5 mm)

51587
Hand shower sliding rail set
 consisting of:
 – rail with sliding bracket, 900 mm
 – height adjustment via handle,
 tilting angle adjustable
 – spacer disc (5 mm)
 – hand shower with normal, soft and massage jet
 – shower hose, 1600 mm

51573/51574
Thermostat battery
 concealed fitting
 with ceramic cut-off valve (51573),
 with ceramic cut-off and switch valve (51574),
 safety cut-off at 38 °C,
 set complete with: handle, sleeve, diverter,
 rosette and installation unit,
 suitable for rough part no. 59970 (Flexx Boxx)
 (Flexx Boxx to be ordered separately)

51591
Wall bracket for hand shower
 for shower hoses with conical nuts

51686/51688
Head shower with ceiling outlet DN 15
 Ø 180 mm, with shower head rail,
 restricted flow rate 15 l/min.
 Projection: 100, 300 mm

51686/51689
Head shower with ceiling outlet DN 15
 Ø 180 mm, with shower head rail,
 restricted flow rate 15 l/min.
 Projection: 100, 300 mm



11501



11507



11510



11553



11554



11556



11514



11515



11518/11519



11520/11522



11558



11559



11521



11549

11550



11552

11555



11562



11563



11564

11501
Towel rail
600, 800, 1000 mm

11514
Towel hook
60 mm

11515
Towel hook
double

11521
Towel ring

11507
Grab bar/Towel rail (USA)
350 mm

11518/11519
Towel holder
2-arms, fixed
Projection: 340, 450 mm

11549
Utensil tray
crystal glas matt

11550
Tumbler holder
complete with crystal glass tumbler

11510
Shelf
with crystalline glass shelf
Dimensions:
700 x 120 mm
1050 x 120 mm
1400 x 120 mm

11520/11522
Towel holder
1-arm, fixed
Projection: 340, 450 mm

11552
Lotion dispenser
complete with crystal glass tumbler, matt
Capacity: approx. 150 ml

11555
Soap holder
complete with crystal glass dish, matt

11553
Double holder glass/lotiondispenser
complete, comes with:
1 x crystal glass tumbler
1 x lotiondispenser for liquid soap
Capacity: approx. 150 ml

11558
Shower shelf
aluminium silver-anodized (E6 EV1)

11562
Toilet paper holder
open form,
for 120 mm wide paper rolls

11554
Double holder glass/utensil tray
complete, comes with:
1 x crystal glass tumbler
1 x utensil tray, crystal glass matt

11559
Shower shelf
aluminium silver-anodized (E6 EV1)
with integrated glass scraper (white)

11563
Spare paper holder

11556
Double holder glass/soap
complete, comes with:
1 x crystal glass tumbler
1 x crystal soap dish, matt

11564
Toilet brush set
complete with crystal glass insert matt, detachable
opaque synthetic insert, brush with handle and lid,
spare brush head



51102



51102



51104



51120



51127



51126



51109



51115



51116



51130



51130



51145

51102
Single lever basin mixer 150
with/without pop-up waste 1 1/4 Inch,
1-hole installation, cartridge mixer
with ceramic sealing gaskets
aerator SLIM SSR M 24 x 1
adjustable flow angle +/- 8°
Flow rate limited to 7,6 l/min.

51102
Single lever basin mixer 250
without pop-up waste,
1-hole installation, cartridge mixer
with ceramic sealing gaskets
aerator SLIM SSR M 24 x 1
adjustable flow angle +/- 8°
Flow rate limited to 7,6 l/min.

51104
Single lever basin mixer 110
with/without pop-up waste 1 1/4 Inch,
1-hole installation, cartridge mixer
with ceramic sealing gaskets
aerator SLIM SSR M 24 x 1
adjustable flow angle +/- 8°
Flow rate limited to 7,6 l/min.

51120
Single lever bath tub mixer
exposed fitting
shut-off valve and diverter with ceramic sealing
gaskets, mixing valve with ceramic sealing gaskets,
wall bracket for shower hose DN 15
(Flow rate limited to 12 l/min.)
with backflow preventer
depth gauge 150 +/- 14 mm
aerator M 28 x 1
flow rate approx. 23 l/min.

51127
Single lever bath tub mixer
floor-mounted/free standing
cartridge mixer with ceramic sealing gaskets,
complete with round pencil shower
and shower hose, 1250 mm
(Floor-mounting set article no. 51127 to
be ordered separately)

51126
Thermostat battery for shower
exposed fitting
handle with 50% water consumption regulation,
safety cut-off at 38°C,
with backflow preventer

51109
Single lever bidet mixer
with pop-up waste 1 1/4 Inch,
1-hole installation, cartridge mixer
with ceramic sealing gaskets,
aerator cache TT M 18,5 x 1
Flow rate limited to 7,6 l/min.

51115
Three hole basin mixer 150
with/without pop-up waste 1 1/4 Inch,
3-hole installation, ceramic valve for temperature
regulation and valve for flow control
Flow rate limited to 7,6 l/min.

51116
Single lever basin mixer
wall-mounted concealed fitting
cartridge mixer with ceramic sealing
gaskets and temperature limiter
aerator SLIM SSR M 24 x 1
adjustable flow angle +/- 8°
Flow rate limited to 7,6 l/min.
(essential for installation: rough part
article no. 51116 to be ordered separately)

Note:
flexible arrangement of lever and spout possible
during assembly.

51130
Bath tub mixer
4-hole bath filler
ceramic valve for temperature regulation
and valve for flow control
aerator M 28 x 1
pull-out pencil hand shower
with backflow preventer
Projection: 180, 220 mm
(suitable fixing block article no. 51130
to be ordered separately)

51130
Bath tub mixer
3-hole bath filler
ceramic valve for temperature regulation
and valve for flow control
pull-out pencil hand shower
with backflow preventer
(suitable fixing block article no. 51130
to be ordered separately)

51145
Bath spout DN 20
suitable for all concealed fittings
Projection: 146, 196 mm



51171



51172



51173



51174



51185



51180



56080



53086/53089



53086/53088



51147



51191



51192



54941



54995

51171
Single lever shower mixer
 concealed fitting
 set complete with: handle, sleeve, rosette
 and installation unit
 suitable for rough part no. 59970 (Flexx Boxx)
 (Flexx Boxx to be ordered separately)

51173
Thermostat battery
 concealed fitting
 with ceramic cut-off valve,
 safety cut-off at 38 °C,
 set complete with: handle, sleeve, diverter,
 rosette and installation unit
 suitable for rough part no. 59970 (Flexx Boxx)
 (Flexx Boxx to be ordered separately)

51172
Single lever bath tub and shower mixer
 concealed fitting
 with/without safety device
 set complete with: handle, sleeve, diverter, rosette
 and installation unit
 suitable for rough part no. 59970 (Flexx Boxx)
 (Flexx Boxx to be ordered separately)

51174
Thermostat battery
 concealed fitting
 with ceramic cut-off and switch valve,
 safety cut-off at 38 °C,
 set complete with: handle, sleeve, diverter,
 rosette and installation unit
 suitable for rough part no. 59970 (Flexx Boxx)
 (Flexx Boxx to be ordered separately)

51185
Hand shower sliding rail
 consisting of:
 – wall rail 900, 1200 mm
 – sliding bracket for hand shower
 – height adjustment via handle,
 tilting angle adjustable
 – spacer disc (5 mm)

51180
Hand shower
 with anti limescale device
 with normal jet
 restricted flow rate 12 l/min.

56080
Round pencil hand shower
 with normal jet

51147
Wall outlet for shower hose DN 15
 suitable for all concealed fittings
 with backflow preventer

53086/53089
Shower head with ceiling outlet DN 15
 with shower head rail
 restricted flow rate 15 l/min.
 Projection: 100, 300 mm

51191
Wall bracket for hand shower
 for shower hoses with conical nuts
 usable on left or right

51192
Wall outlet for hand shower DN 15
 with integrated wall outlet
 for shower hoses with conical nuts
 suitable for all concealed fittings
 with backflow preventer

53086/53088
Shower head with wall outlet DN 15
 with shower head rail
 restricted flow rate 15 l/min.
 Projection: 300, 450 mm

54941
Exposed part for angle valve DN 15/DN 20
 complete with: handle, sleeve, rosette
 and adjustable extension
 (Angle valve DN 15/DN 20 to be ordered separately)

54995
Shower hose DN 15
 both ends fitted with conical nut
 and twist-protection
 1250, 1600, 2000 mm



11101



11107



11110



11158



11159



11162

11163



11114



11115



11116



11121



11164



11150



11151



11118/11119



11120/11122



11170



11172



11152



11153



11155

11101
Towel rail
600, 800, 1000 mm

11114
Towel hook
47 mm

11115
Towel hook
double, 46 mm

11118/11119
Towel holder
2-arms, fixed
Projection: 340, 450 mm

11107
Grab bar/Towel rail (USA)
300 mm

11116
Robe hook
67 mm

11120/11122
Towel holder
1-arm, fixed
Projection: 340, 450 mm

11110
Shelf
with crystalline glass shelf
Dimensions (w x h):
700 x 120 mm
1050 x 120 mm
1400 x 120 mm

11121
Towel ring

11170
Towel holder
holds 6 guest towels
(approx. 30 x 50 cm)

11172
Guest towel basket
removable,
MDF white lacquered
Dimensions (w x h x d): 200 x 350 x 200 mm

11158
Shower basket
aluminium silver anodized/chrome-plated
Dimensions (w x h x d): 300 x 95 x 67 mm

11164
Toilet brush set
with crystal glass insert, matt,
brush with handle and spare brush head

11152
Lotion dispenser
complete with crystal glass, matt
Capacity: approx. 180 ml

11159
Shower basket
aluminium silver anodized/chrome-plated
with integrated glass scraper
Dimensions (w x h x d): 300 x 95 x 67 mm

11150
Tumbler holder
complete with crystal glass tumbler, hand-
blown

11153
Double holder
consisting of:
– 1 x crystal glass matt, hand-blown
– 1 x lotion dispenser (crystal glass, matt)
complete with pump for liquid soap
Capacity: approx. 180 ml

11162
Toilet paper holder
open form,
for 120 mm wide paper rolls

11163
Spare paper holder

11151
Double tumbler holder
complete with crystal glasses, hand-blown

11155
Soap holder
complete with removable crystal glass dish



11153



11156



11169



11177

11153
Foam soap dispenser
 standing model, porcelain
 Capacity: approx. 500 ml

11156
Porcelain dish
 standing model, porcelain

11169
Porcelain container
 standing model, porcelain

11177
Tissue box
 standing model, porcelain



53002



53004



53015



53009



53020



53030



53030



53024

53002
Single lever basin mixer 190
 with/without pop-up waste 1 1/4 Inch,
 1-hole installation, cartridge mixer
 with ceramic sealing gaskets
 and temperature limiter
 aerator M 21,5 x 1 cache
 Flow rate limited to 7,6 l/min.

53030
Single lever bath tub and shower mixer
 4-hole bath deck-mounted
 cartridge mixer with ceramic sealing gaskets
 and temperature limiter, with automatic diverter
 and backflow preventer,
 concealable hand shower with normal-, soft-
 and massage jet
 (mounting set article no. 53030 to be
 ordered separately)

53004
Single lever basin mixer 150
 without pop-up waste,
 1-hole installation, cartridge mixer
 with ceramic sealing gaskets
 and temperature limiter
 aerator M 21,5 x 1 cache
 Flow rate limited to 7,6 l/min.

53009
Single lever bidet mixer
 with pop-up waste 1 1/4 Inch,
 1-hole installation, cartridge mixer
 with ceramic sealing gaskets
 and temperature limiter
 aerator M 24 x 1

53030
Single lever bath tub and shower mixer
 3-hole bath deck-mounted
 cartridge mixer with ceramic sealing gaskets
 and temperature limiter, with automatic diverter
 and backflow preventer,
 concealable hand shower with normal-, soft-
 and massage jet
 (mounting set article no. 53030 to be
 ordered separately)

53015
Three-hole basin mixer 140
 model with rosettes
 with/without pop-up waste 1 1/4 Inch,
 3-hole installation, 90° head part
 with ceramic sealing gaskets

53020
Single lever bath tub mixer
 exposed fitting
 cartridge mixer with ceramic sealing gaskets
 and temperature limiter, with automatic diverter,
 with backflow preventer

53024
Single lever shower mixer DN15
 exposed fitting
 cartridge mixer with ceramic sealing gaskets
 with backflow preventer

Surface chrome-plated



53072

53072
Single lever bath tub and shower mixer
 concealed fitting
 with/without safety device
 set complete with: handle, sleeve, diverter,
 rosette and installation unit
 suitable for rough part no. 59970 (Flexx Boxx)
 (Flexx Boxx to be ordered separately)



53071

53071
Single lever shower mixer
 concealed fitting
 set complete with: handle, sleeve, rosette
 and installation unit
 suitable for rough part no. 59970 (Flexx Boxx)
 (Flexx Boxx to be ordered separately)

53045
Bath filler/spout DN20
 suitable for all concealed fittings
 Projection: 164, 214 mm



53045



53073

53073/53074
Thermostat battery
 concealed fitting
 with ceramic cut-off valve (53073),
 with ceramic cut-off and switch valve (53074),
 safety cut-off at 38 °C,
 set complete with: handle, sleeve, diverter,
 rosette and installation unit
 suitable for rough part no. 59970 (Flexx Boxx)
 (Flexx Boxx to be ordered separately)



53074



53086/53088

53086/53088
Shower head with wall outlet DN 15
 with shower head rail
 restricted flow rate 15 l/min.
 Projection: 300, 450 mm



53086/53089

53086/53089
Shower head with ceiling outlet DN 15
 with shower head rail
 restricted flow rate 15 l/min.
 Projection: 100, 300 mm



53947

53947/53047
Wall outlet for shower hose DN 15
 suitable for all concealed fittings



53047



51147

51147
Wall outlet for shower hose DN 15
 suitable for all concealed fittings
 with backflow preventer



51191

51191
Wall bracket for hand shower
 for shower hoses with conical nuts
 usable on left or right



51192

51192
Wall outlet for hand shower DN 15
 with integrated wall outlet
 for shower hoses with conical nuts
 suitable for all concealed fittings
 with backflow preventer



54941

54941
Exposed part for angle valve DN 15/DN 20
 complete with: handle, sleeve, rosette
 and adjustable extension
 (Angle valve DN 15/DN 20 to be ordered separately)



59991

59991
Wall bracket for hand shower
 for shower hoses with conical nuts,
 with adjustable tilt angle 20-65°
 Projection: 97 mm

54991
Wall bracket for hand shower
 for shower hoses with conical nuts



54995



54980



30010



30015



30018/30019



30007



850 mm

54985

54987

923 mm,
1223 mm

51185

51187



30021



30050

30052



30055



30001



30063



30060



30064



30070

54995
Shower hose DN 15
both ends fitted with conical nut
and twist-protection
1250, 1600, 2000 mm

30007
Grab bar/Towel rail (USA)
300 mm

30001
Towel rail
600, 800 mm

54980
Hand shower
with anti limescale device
Functions:
– normal jet
– soft jet
– massage jet

54985
Hand shower sliding rail
consisting of:
– wall rail, 800 mm
– sliding bracket for shower head
– height adjustment via handle,
tilting angle adjustable
– spacer disc (5 mm)

54987
Hand shower sliding rail set
consisting of:
– rail with sliding bracket, 800 mm
– height adjustment via handle,
tilting angle adjustable
– spacer disc (5 mm)
– hand shower with normal, soft and massage jet
– shower hose, 1600 mm

51185
Hand shower sliding rail
consisting of:
– wall rail 900, 1200 mm
– sliding bracket for hand shower
– height adjustment via handle,
tilting angle adjustable
– spacer disc (5 mm)

51187
Hand shower sliding rail set
consisting of:
– wall rail 900, 1200 mm
– sliding bracket for hand shower
– height adjustment via handle,
tilting angle adjustable
– spacer disc (5 mm)
– hand shower with normal jet
– shower hose, 1600 mm

30010
Shelf
with crystalline glass shelf, underside matt
Dimensions (w x h):
650 x 120 mm
950 x 120 mm
1250 x 120 mm

30021
Towel ring
Ø 210 mm
Projection: 212 mm

30063
Spare paper holder

30060
Toilet paper holder
with lid,
for 100/120 mm wide paper rolls

30015
Towel hook
double

30050
Tumbler holder
complete with crystal glass tumbler, matt

30052
Lotion dispenser
complete with crystal glass tumbler, matt
Capacity: approx. 180 ml

30064
Toilet brush set
complete with crystal glass insert, matt
and brush

30018/30019
Towel holder
fixed
Projection: 320, 465 mm

30055
Soap holder
complete with crystal glass dish, matt

30070
Towel holder
holds 6 guest towels
(approx. 30 x 50 cm)



51602



51604



51608



SENSOR

51611



51601



SENSOR

51613



51616



51620



51609



51620



51645



51630

51602
Single lever basin mixer 120
 with/without pop-up waste 1 1/4 Inch,
 1-hole installation, cartridge mixer
 with ceramic sealing gaskets
 aerotor M 24 x 1
 Flow rate limited to 7,6 l/min.

51604
Single lever basin mixer 90
 with/without pop-up waste 1 1/4 Inch,
 1-hole installation, cartridge mixer
 with ceramic sealing gaskets
 aerotor M 24 x 1
 Flow rate limited to 7,6 l/min.

51608
Pillar tap 90
 without pop-up waste,
 1-hole installation, lever head action 90°
 with ceramic sealing gaskets

51611
Infrared basin mixer 120
 with/without pop-up waste 1 1/4 Inch,
 1-hole installation, infrared sensor,
 manual water-stop for cleaning,
 with temperature control,
 aerotor M 24 x 1
 either battery or mains operated

51601
Extension to single lever basin mixer
 matches single lever basin mixers 51602 and 51604,
 pillar tap 51608 and infrared basin mixers 51611
 and 51613

Please note: Single lever basin mixer to be
 ordered separately!

51613
Infrared basin mixer 120
 without pop-up waste,
 1-hole installation, infrared sensor,
 manual water-stop for cleaning,
 without temperature control,
 aerotor M 24 x 1
 either battery or mains operated

51616
Single lever basin mixer
 concealed fitting DN 15
 cartridge mixer with ceramic sealing gaskets
 and temperature control,
 aerator SLIM SSR M 24 x 1,
 adjustable flow angle
 (essential for installation: rough part
 article no. 51116 to be ordered separately)

Note:
 flexible arrangement of lever and spout possible
 during assembly.

51620
Single lever bath tub mixer with head shower
 exposed fitting
 cartridge mixer with ceramic sealing gaskets,
 with automatic diverter, with backflow preventer,
 head shower swivelling, Ø 180 mm,
 hand shower with normal, soft and massage jet,
 with sliding bracket, wall bracket
 and shower hose, 1600 mm

51609
Single lever bidet mixer
 with pop-up waste 1 1/4 Inch,
 1-hole installation, cartridge mixer
 with ceramic sealing gaskets
 aerotor M 24 x 1

51620
Single lever bath tub mixer
 exposed fitting
 cartridge mixer with ceramic sealing gaskets,
 with automatic diverter and backflow preventer

51645
Bath filler/spout DN 20
 suitable for all concealed fittings
 Projection: 173, 223 mm

51630
Single lever bath tub and shower mixer
 4-hole bath deck-mounted
 cartridge mixer with ceramic sealing gaskets,
 with automatic diverter and backflow preventer
 concealable hand shower with normal, soft
 and massage jet



51624



51624



51626



51626



51671



51672



51673



51674



51686/51689



51686/51688



51680



54995

51624
Single lever bath shower mixer with head shower
 exposed fitting
 cartridge mixer with ceramic sealing gaskets, diverter head shower/hand shower with ceramic sealing gaskets, with backflow preventer, head shower swivelling, Ø 180 mm, hand shower with normal-, soft- and massage jet, with sliding bracket, wall bracket and shower hose, 1600 mm

51624
Single lever shower mixer DN 15
 exposed fitting
 cartridge mixer with ceramic sealing gaskets, with backflow preventer

51626
Thermostat battery for shower
 exposed fitting
 handle with 50% water consumption regulation, safety cut-off at 38°C, with backflow preventer

51626
Thermostat battery with head shower
 exposed fitting
 safety cut-off at 38°C, diverter head shower/hand shower with ceramic sealing gaskets, with backflow preventer
 head shower swivelling, Ø 180 mm, hand shower with normal-, soft- and massage jet, with sliding bracket, wall bracket and shower hose, 1600 mm

51671
Single lever shower mixer
 concealed fitting
 set complete with: handle, sleeve, rosette and installation unit
 suitable for rough part no. 59970 (Flexx Boxx) (Flexx Boxx to be ordered separately)

51673/51674
Thermostat battery
 concealed fitting
 with ceramic cut-off valve (51673), with ceramic cut-off and switch valve (51674), safety cut-off at 38°C, set complete with: handle, sleeve, diverter, rosette and installation unit
 suitable for rough part no. 59970 (Flexx Boxx) (Flexx Boxx to be ordered separately)

51672
Single lever bath tub and shower mixer
 concealed fitting
 with/without safety device
 set complete with: handle, sleeve, diverter, rosette and installation unit
 suitable for rough part no. 59970 (Flexx Boxx) (Flexx Boxx to be ordered separately)

51686/51689
Head shower with ceiling outlet DN 15
 Ø 180 mm, with shower head rail, restricted flow rate 15 l/min.
 Projection: 100, 300 mm

51686/51688
Overhead shower with wall outlet DN 15
 Ø 180 mm, with shower head rail, restricted flow rate 15 l/min.
 Projection: 300, 450 mm

51680
Hand shower
 with anti limescale device
 Functions:
 – normal jet
 – soft jet

54995
Shower hose DN 15
 both ends fitted with conical nut and twist-protection
 1250, 1600, 2000 mm



31606



31614



51685

51687

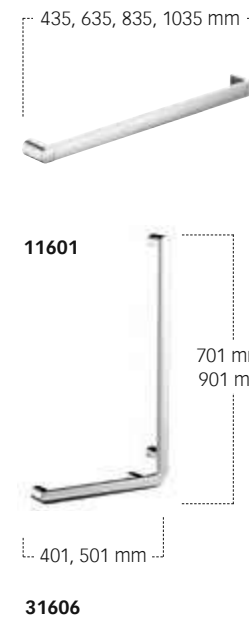

11601

31606



11607

11610



31601

11613 / 11614

11615 / 11616



59991



54991



54941



54947



11618/11620



11621



11649

31606
Angle bar 90°
for use as shower rail
complete with shower bracket
usable as shower rail on left or right
Dimensions (w x h): 400 x 1100 mm

59991
Wall bracket for hand shower
for shower hoses with conical nuts,
with adjustable tilt angle 20-65°
Projection: 97 mm

54991
Wall bracket for hand shower
for shower hoses with conical nuts

31614
Rail system
complete with shower bracket
shower rail flexible positioning of
sliding rail prior to final installation
Dimensions (w x h):
600 x 1100 mm
800 x 1100 mm
1000 x 1100 mm

54941
Exposed part for angle valve DN 15/DN 20
complete with: handle, sleeve, rosette
and adjustable extension
(Angle valve DN 15/DN 20
to be ordered separately)

54947
Wall outlet for shower hose DN 15
suitable for all concealed fittings

51685
Hand shower sliding rail
consisting of:
– wall rail, 900 mm
– sliding bracket for shower head
– height adjustment via handle,
tilting angle adjustable
– spacer disc (5 mm)

51687
Hand shower sliding rail set
consisting of:
– rail with sliding bracket, 900 mm
– height adjustment via handle,
tilting angle adjustable
– spacer disc (5 mm)
– hand shower with normal jet and soft jet
– shower hose, 1600 mm

11601
Towel rail
400, 600, 800, 1000 mm

31606
Angle bar 90°
optional left and right version
Dimensions (w x h):
300 x 600 mm
400 x 800 mm

11618/11620
Towel holder
2-arms, swivelling
Projection: 340, 450 mm

11607
Grab bar/Towel rail (USA)
300 mm

11610
Shelf
with crystal or crystalline glass shelf
Dimensions (w x h x d):
360 x 131 x 10 mm
600 x 131 x 10 mm
700 x 131 x 10 mm
950 x 131 x 10 mm

11621
Towel ring
Projection: 95 mm

31601
Grab bar/Towel rail (USA)
400, 500, 600, 700, 800, 900, 1000, 1100 mm

11613/11614
Towel hook
double, 34 mm

11615
Towel hook
59 mm

11616
Robe hook
82 mm

11649
Soap dispenser
for mounting on washbasin or washbasin worktop,
including foam soap (2 x 500 ml),
also available for liquid soap
Capacity: approx. 500 ml
Height: 93 mm



11650



11652



11653



11660



11664



11662

11663



11654



11657



11658



11669



11667



11655



11675



17676

17677



01680



11682



11692

11650
**Tumbler holder/
 Tumbler holder table model**
 complete with crystal glass tumbler, matt

11654
**Lotion dispenser/
 Lotion dispenser table model**
 opal glass, matt
 Capacity: approx. 220 ml

11655
**Soap holder/
 Soap holder table model**
 complete with removable crystal glass dish, matt

11652
Lotion dispenser
 complete with plastic cup, matt
 also suitable for the shower
 Capacity: approx. 180 ml

11652
Lotion dispenser
 complete with crystal glass cup, matt
 Capacity: approx. 180 ml

11657
Sponge basket for corner installation
 metal basket with removable insert
 in white or anthracite
 Dimensions (w x h x d): 180 x 180 x 70 mm

11675
Towel rack
 620 mm

11653
**Foam soap dispenser/
 Foam soap dispenser table model**
 opal glass, matt
 including foam soap (2 x 500 ml)
 Capacity: approx. 220 ml

11658
Sponge basket
 metal basket with removable insert
 in white or anthracite
 Dimensions (w x h x d): 239 x 105 x 70 mm

17676
Cosmetic mirror
 illuminated, wall model,
 optional with mains connection through wall socket
 or with spiral cord and plug,
 1 x 8 W energy efficient lamp
 magnification factor x 5, Ø 207 mm

17677
Cosmetic mirror
 illuminated, table model,
 with power lead (1,70 m),
 1 x 8 W energy-efficient light lamp
 magnification factor x 5, Ø 207 mm

11660
Toilet paper holder
 with lid,
 for 100/120 mm wide paper rolls

11669
Toilet brush set
 complete with crystal glass insert, matt,
 brush and spare brush head

01680
Tip-up seat
 with Keucolit-seat, white

11664
Toilet brush set
 with lid,
 complete with synthetic insert,
 brush and spare brush head

11667
Moisture box
 comes with porcelain box, white

11682
Bathroom stool
 chrome-plated, walnut veneer

11662
Toilet paper holder
 open form,
 for 100/120 mm wide paper rolls

11663
Spare paper holder

11692
Wall light
 horizontal or vertical installation,
 mirrored front panel, both task lighting and
 moodlight, switched separately via room switch,
 fluorescent lamps
 Illumination/Dimensions (w x h x d):
 2 x 14 W T5/700 x 70 x 66 mm
 2 x 21 W T5/950 x 70 x 66 mm



54902



54902



54902



54911



54912



54903



54904



54911



54908



54909

54902
Single lever basin mixer 80
with/without pop-up waste 1 1/4 Inch,
1-hole installation, cartridge mixer
with ceramic sealing gaskets and
temperature limiter
aerator M 24 x 1
vandal proof

54903
Single lever basin mixer 80
for use with instant water heaters only
with/without pop-up waste 1 1/4 Inch,
1-hole installation, cartridge mixer
with ceramic sealing gaskets and
temperature limiter
aerator M 24 x 1
vandal proof

54902
Single lever basin mixer 80
with extended handle
with/without pop-up waste 1 1/4 Inch,
1-hole installation, cartridge mixer
with ceramic sealing gaskets and
temperature limiter,
aerator M 24 x 1
vandal proof

54904
Single lever basin mixer 70
without pop-up waste,
1-hole installation, cartridge mixer
with ceramic sealing gaskets and
temperature limiter
aerator M 24 x 1

54902
Single lever basin mixer 80
with extended spout and handle
with pop-up waste 1 1/4 Inch,
1-hole installation, cartridge mixer
with ceramic sealing gaskets and
temperature limiter
aerator M 24 x 1
vandal proof

54911
Infrared basin mixer 80
with pop-up waste 1 1/4 Inch,
1-hole installation, monoblock without base,
infrared sensor (battery 6 V lithium DL 223 A)

54911
Infrared basin mixer 80
with/without pop-up waste,
1-hole installation, monoblock without base,
aerator M 24 x 1
infrared sensor (battery 6 V lithium DL 223 A)

54908
Pillar tap 50
without pop-up waste,
1-hole installation, lever head action 90°
with ceramic sealing gaskets
aerator M 18 x 1

54912
Infrared basin mixer 80
without pop-up waste,
1-hole installation, monoblock without base,
aerator M 24 x 1
infrared sensor (mains operation 230 V)

54909
Single lever bidet mixer
with pop-up waste 1 1/4 Inch,
1-hole installation, cartridge mixer
with ceramic sealing gaskets
and temperature limiter
aerator M 24 x 1



54945



54971



51686/51688



54947



54972



54973



54974



54985

54987



51686/51689

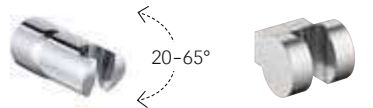

59991

54991



54920



54924



54926



54980

56080



54941

54995

54945
Bath filler/spout DN 20
suitable for all concealed fittings
Projection: 135, 185 mm

54972
Single lever bath tub mixer
concealed fitting
with/without safety device
set complete with: handle, sleeve, diverter,
rosette and installation unit
suitable for rough part no. 59970 (Flexx Boxx)
(Flexx Boxx to be ordered separately)

54920
Single lever bath tub mixer
exposed fitting
cartridge mixer with ceramic sealing gaskets
and temperature limiter,
with automatic diverter and backflow preventer

54971
Single lever shower mixer
concealed fitting
set complete with: handle, sleeve, rosette
and installation unit
suitable for rough part no. 59970 (Flexx Boxx)
(Flexx Boxx to be ordered separately)

54973/54974
Thermostat battery
concealed fitting
with ceramic cut-off valve (54973),
with ceramic cut-off and switch valve (54974),
safety cut-off at 38 °C,
set complete with: handle, sleeve, diverter,
rosette and installation unit
suitable for rough part no. 59970 (Flexx Boxx)
(Flexx Boxx to be ordered separately)

54924
Single lever shower mixer DN 15
exposed fitting
cartridge mixer with ceramic sealing gaskets,
with backflow preventer

54926
Thermostat battery for shower
exposed fitting
handle with 50% water consumption regulation,
safety cut-off at 38 °C, with backflow preventer

54985
Hand shower sliding rail
consisting of:
– wall rail, 800 mm
– sliding bracket for shower head
– height adjustment via handle,
tilting angle adjustable
– spacer disc (5 mm)

54987
Hand shower sliding rail set
consisting of:
– rail with sliding bracket, 800 mm
– height adjustment via handle,
tilting angle adjustable
– spacer disc (5 mm)
– hand shower with normal jet and massage jet
– shower hose, 1600 mm

51686/51688
Overhead shower with wall outlet DN 15
Ø 180 mm, with shower head rail,
restricted flow rate 15 l/min.
Projection: 300, 450 mm

51686/51689
Head shower with ceiling outlet DN 15
Ø 180 mm, with shower head rail,
restricted flow rate 15 l/min.
Projection: 100, 300 mm

54980
Hand shower
with anti limescale device
Functions:
– normal jet
– soft jet
– massage jet

56080
Round pencil hand shower
surface chrome-plated
with normal jet

54947
Wall outlet for shower hose DN 15
suitable for all concealed fittings

59991
Wall bracket for hand shower
for shower hoses with conical nuts,
with adjustable tilt angle 20-65°
Projection: 97 mm

54991
Wall bracket for hand shower
for shower hoses with conical nuts

54941
Exposed part for angle valve DN 15/DN 20
complete with: handle, sleeve, rosette
and adjustable extension
(Angle valve DN 15/DN 20 to be
ordered separately)

54995
Shower hose DN 15
both ends fitted with conical nut
and twist-protection
1250, 1600, 2000 mm

Surface chrome-plated
Surface aluminium silver anodized (E6 EV1) or aluminium finish
Surface stainless steel or stainless steel finish



53902 **WELL**
Water Efficiency Label



53902 **WELL**
Water Efficiency Label



53902 **WELL**
Water Efficiency Label



53909



53905 **WELL**
Water Efficiency Label
applied



53908



53945



53920



53924

53902
Single lever basin mixer 90
with/without pop-up waste 1 1/4 Inch,
1-hole installation, cartridge mixer
with ceramic sealing gaskets
and temperature limiter,
aerator M 24 x 1
adjustable flow angle +/- 8° limiter,
restricted flow rate 6 l/min.
Height: 161 mm
Projection: 107 mm

53902
Single lever basin mixer 130
with/without pop-up waste 1 1/4 Inch,
1-hole installation, cartridge mixer
with ceramic sealing gaskets
and temperature limiter,
aerator M 24 x 1
adjustable flow angle +/- 8° limiter,
restricted flow rate 6 l/min.
Height: 204 mm
Projection: 125 mm

53905
Single lever basin mixer 200
with/without pop-up waste 1 1/4 Inch,
spout swivelling +/- 60°,
1-hole installation, cartridge mixer
with ceramic sealing gaskets,
aerator M 24 x 1 cache
restricted flow rate 6 l/min.

53902
Single lever basin mixer 210
without pop-up waste,
1-hole installation, cartridge mixer
with ceramic sealing gaskets
and temperature limiter,
aerator M 24 x 1
adjustable flow angle +/- 8° limiter,
restricted flow rate 6 l/min.
Height: 289 mm
Projection: 140 mm

53908
Pillar tap 200
without pop-up waste,
spout swivelling +/- 60°,
1-hole installation, lever head action 90°
with ceramic sealing gaskets,
aerator M 24 x 1 cache

53909
Single lever bidet mixer
with pop-up waste 1 1/4 Inch,
1-hole installation, cartridge mixer
with ceramic sealing gaskets
and temperature limiter,
aerator M 24 x 1
restricted flow rate 6 l/min.

53945
Bath filler/spout DN 20
suitable for all concealed fittings
Projection: 138, 188 mm

53920
Bath tub mixer DN 15
exposed fitting
cartridge mixer with ceramic sealing gaskets,
ceramic stop valve and diverter,
with backflow preventer
wall outlet for shower hose DN 15,
restricted flow rate 12 l/min.

53924
Shower mixer DN 15
exposed fitting
ceramic stop valve,
cartridge mixer with ceramic sealing gaskets,
with backflow preventer
wall outlet for shower hose DN 15,
restricted flowrate 12 l/min.



53971



53972



53924



54985

54987



51686 / 51688



51686 / 51689



53980



59991



54941



54991



54995



53947

53971
Single lever shower mixer
 concealed fitting
 set complete with: handle, sleeve, rosette and installation unit
 suitable for rough part no. 59970 (Flexx Boxx) (Flexx Boxx to be ordered separately)

53972
Single lever bath tub and shower mixer
 concealed fitting
 with/without safety device
 set complete with: handle, sleeve, diverter, rosette and installation unit
 suitable for rough part no. 59970 (Flexx Boxx) (Flexx Boxx to be ordered separately)

53924
Shower mixer with head shower
 exposed fitting
 ceramic stop valve and diverter, cartridge mixer with ceramic sealing gaskets, with backflow preventer
 head shower swivelling, Ø 180 mm, restricted flowrate 9 l/min., hand shower with normal-, soft- and massage jet, with sliding bracket, wall bracket and shower hose, 1600 mm

54985
Hand shower sliding rail
 consisting of:
 – wall rail, 800 mm
 – sliding bracket for shower head
 – height adjustment via handle, tilting angle adjustable
 – spacer disc (5 mm)

54987
Hand shower sliding rail set
 consisting of:
 – rail with sliding bracket, 800 mm
 – height adjustment via handle, tilting angle adjustable
 – spacer disc (5 mm)
 – hand shower with normal jet and massage jet
 – shower hose, 1600 mm

51686 / 51688
Overhead shower with wall outlet DN 15
 Ø 180 mm, with shower head rail, restricted flow rate 15 l/min.
 Projection: 300, 450 mm

51686 / 51689
Head shower with ceiling outlet DN 15
 Ø 180 mm, with shower head rail, restricted flow rate 15 l/min.
 Projection: 100, 300 mm

53980
Hand shower
 with anti limescale device
 Functions:
 – normal jet
 – soft jet
 – massage jet

59991
Wall bracket for hand shower
 for shower hoses with conical nuts, with adjustable tilt angle 20-65°
 Projection: 97 mm

54941
Exposed part for angle valve DN 15/DN 20
 complete with: handle, sleeve, rosette and adjustable extension
 (Angle valve DN 15/DN 20 to be ordered separately)

54991
Wall bracket for hand shower
 for shower hoses with conical nuts

54995
Shower hose DN 15
 both ends fitted with conical nut and twist-protection
 1250, 1600, 2000 mm

53947
Wall outlet for shower hose DN 15
 suitable for all concealed fittings



14901



14907



14910



14958



14950



14953



14911/14914/14916



14913



14918/14919



14952



14953



14957



14921

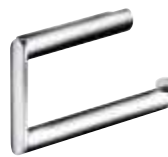

14922



14955



14949



11649



14954



14956

14901
Towel rail
600, 800 mm

14907
Grab bar/Towel rail (USA)
300 mm

14910
Shelf
with crystalline plate, underside matt
Dimensions (w x h):
220 x 100 mm
350 x 120 mm
550 x 120 mm

14958
Universal shelf
with crystal glass plate
Surface chrome-plated, stainless steel or
aluminium silver anodized (E6 EV1)/chrome-plated
Dimensions (w x h): 210 x 115 mm

14950
Tumbler holder
complete with crystal glass tumbler

14953
Lotion dispenser
complete with crystal glass, matt
Capacity: approx. 250 ml

14911
Towel hook
with door buffer, black

14913
Towel hook panel
with 4 hooks

14918/14919
Towel holder
2-arms, swivelling
Projection: 300, 438 mm

14952
Lotion dispenser standing model
Capacity: approx. 250 ml

14953
Lotion dispenser wall model
Capacity: approx. 250 ml

14957
Foam soap dispenser
opal glass, matt
including foam soap (2 x 250 ml)
Capacity: approx. 250 ml

14914/14916
Towel hook

14922
Towel ring
small model

14955
Soap holder
complete with crystal glass dish

14949
Built in soap dispenser
for mounting on washbasin
or washbasin worktop
Capacity: approx. 500 ml

14954
Lotion dispenser
Capacity: approx. 1,1 l

14956
Lotion dispenser
sensor controlled
Capacity: approx. 0,8 l
4 batteries 1,5 V AA necessary
Batteries please order separately!

Surface chrome-plated
Surface aluminium silver anodized (E6 EV1) or aluminium finish
Surface stainless steel or stainless steel finish

11649
Soap dispenser
for mounting on washbasin or washbasin worktop,
including foam soap (2 x 500 ml),
also available for liquid soap
Capacity: approx. 500 ml
Height: 93 mm



14960



14961



14962



04979



14982



04976



14963



14969



14985



14988



14995



07749 / 10095



14972

14964



14966-14971



14977

04988



17649



06549



14980



14983

14960 Toilet paper holder
with cover,
for 100/120 mm wide paper rolls

14961 Toilet paper holder
theft-proof,
for 100/120 mm wide paper rolls

14962 Toilet paper holder
open form,
for 100/120 mm wide paper rolls

04979 Clothes line
complete with wall mounting element
extendable up to max. 2.80 m

14982 Bathroom stool
also suitable for wet rooms
seat white, dark grey or light grey
Surface chrome-plated
or aluminium silver anodized (E6 EV1)

07749 / 10095 Crystal mirror
Dimensions (w x h):
220 x 800 mm
350 x 850 mm
550 x 850 mm

04976 Hygiene bag dispenser
ABS plastic for max. 25 bags,
including first 25 bags

14963 Spare paper holder

14969 Multiple toilet roll dispenser
for horizontal or vertical installation,
can be mounted for 2 rolls of 100/120 mm in width

14985 Paper towel dispenser

14995 Hair dryer
with wall mounting element, 230 V
Features:
– On-off switch with indicator light
on the wall holder
– 3 heating levels up to max. 1800 W
– 2 speed levels
– Cold air button
– Overheating protection

14980 Tip-up seat
for wall mounting
tip-up seat
seat size: 360 mm wide
white, dark grey or light grey
Surface chrome-plated
or aluminium silver anodized (E6 EV1)

14972 / 14964 Toilet brush set
with removable plastic insert,
brush and spare brush head

14966 Doorplate
Symbol Ladies

14977 Sanitary waste bin
wall mounted
Capacity: 3 l

14988 Waste bin
wall mounted
Capacity: 30 l

06549 Wall light
complete with opal glass, matt
and bulbs 2 x 40 W E14

14983 Tip-up seat
for wall mounting
tip-up seat
seat size: 370 mm wide
white, dark grey or light grey
Surface chrome-plated or aluminium laquered

Surface chrome-plated
Surface aluminium silver anodized (E6 EV1) or aluminium finish
Surface stainless steel or stainless steel finish

Colour variations

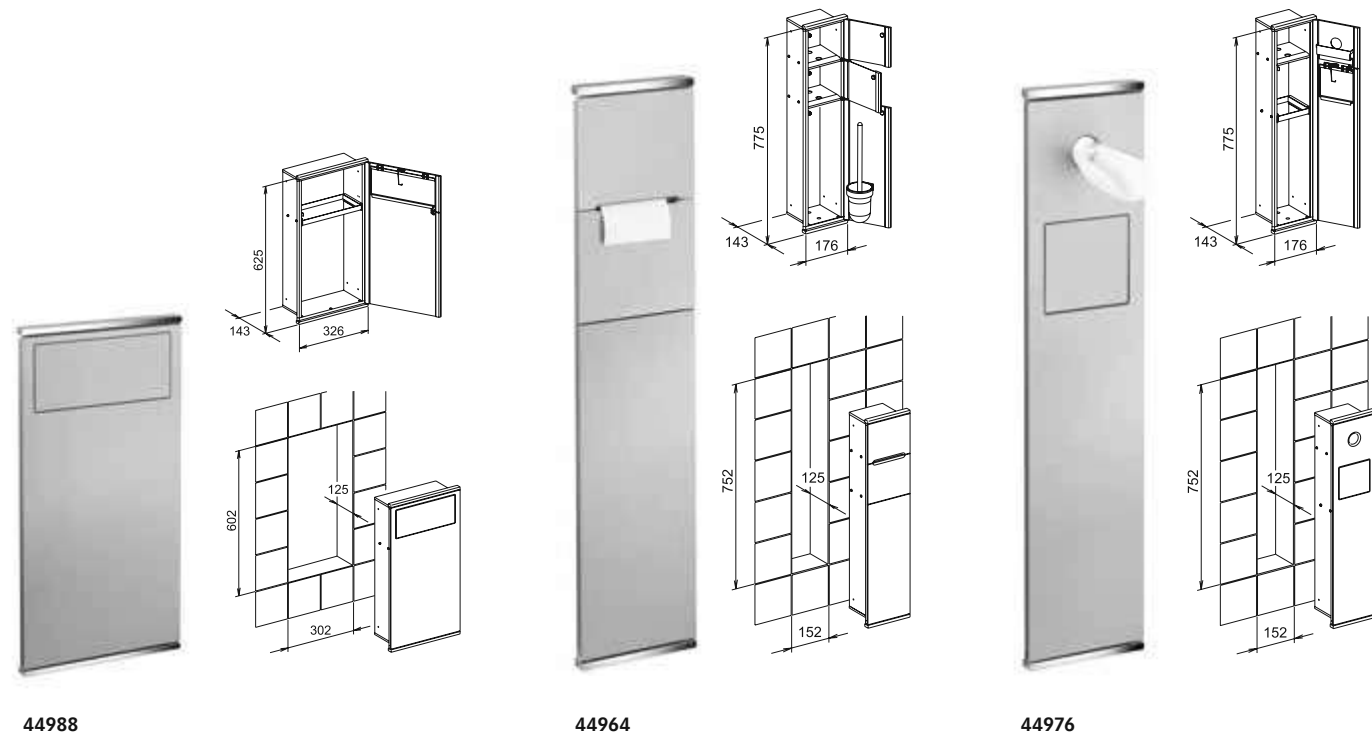

44988

44964

44976

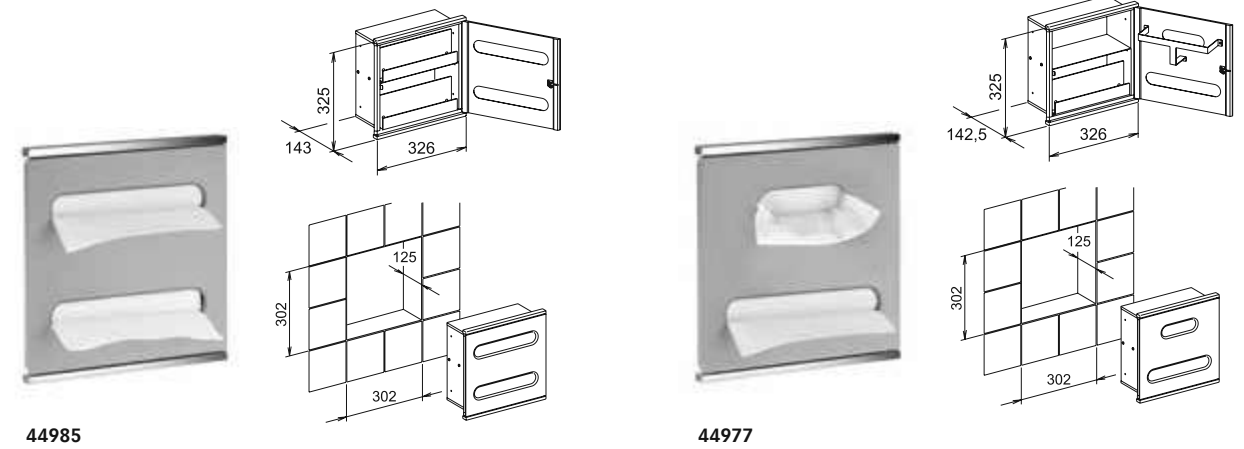

44985

44977

44988
Module Washstand 1
 consisting of:
 – Waste bin

44964
Module WC 1
 consisting of:
 – Toilet brush holder
 – Toilet roll holder
 – Spare toilet roll compartment

44976
Module WC 2
 consisting of:
 – Sanitary bag dispenser
 (including the first pack of hygiene bags)
 – Sanitary waste bin

44985
Module Washstand 2
 consisting of:
 – 2 Paper towel dispensers
 (each for max. 100 paper towels)

44977
Module Washstand 3
 consisting of:
 – Tissue box (for max. 150 tissues)
 – Paper towel dispenser
 (for max. 100 paper towels)



14930 / 14932



14927



14934



14935



14924 / 14925



14936 / 14937



14939



14931 / 14941











14938



14940

Colour variations shower curtain

	white PLAN uni and PLAN maxx		truffle/white PLAN stripes
	light grey PLAN uni		anthracite/white PLAN stripes
	Ecru PLAN uni		black/white PLAN stripes
	truffle PLAN uni		
	anthracite PLAN uni		
	black PLAN uni		
	off-white PLAN Flame CS		



14945 / 14943 / 14944 / 14946 / 14947 / 34948

14930
Shower curtain rail
300-2000 mm

14932
Connecting tube

14924
Tube angle piece 90°
for square shower tray

14925
Tube angle piece 90°
for quarter-circle shower tray

14931
Connecting piece
in dark grey or chrome-plated

14941
Ceiling support (set)
complete, consisting of:
- 1 x wall mounting set
- 1 x shower curtain rail
- 1 x connecting piece, 300-800 mm

Surface chrome-plated
Surface aluminium silver anodized (E6 EV1) or aluminium finish
Surface stainless steel or stainless steel finish

14927
Curtain ring
in black or white

14936 / 14937
Set of shower curtain rails
for square shower tray 800 x 800 mm/900 x 900 mm
consisting of:
- 3 x wall mounting set
- 2 x shower curtain rail, 700 mm/800 mm
- 1 x tube angle piece 90° for square shower tray
- 1 x ceiling support, 400 mm
- 1 x connecting piece
- 2 x 10 shower curtain rings, white

14938
Set of shower curtain rails
for quarter-circle shower tray 900 x 900 mm
consisting of:
- 3 x wall mounting set
- 2 x shower curtain rail, 300 mm
- 1 x tube angle piece 90°
for quarter-circle shower tray
- 1 x ceiling support, 400 mm
- 1 x connecting piece
- 2 x 10 shower curtain rings, white

14934
Wall mounting set
with cover, for slanted ceilings
adjustable between 10 to 80 degrees

14935
Wall mounting set
with decor cover

14939
Set of shower curtain rails
for square shower tray 1000 x 1000 mm/1200 x 1200 mm
consisting of:
- 2 x wall mounting set
- 2 x shower curtain rail, 900 mm/1100 mm
- 1 x tube angle piece 90° for square shower tray
- 1 x ceiling support, 400 mm
- 2 x 10 shower curtain rings, white

14940
Set of shower curtain rails
for square shower tray 1000 x 1000 mm/1200 x 1200 mm
consisting of:
- 2 x wall mounting set
- 2 x shower curtain rail, 900 mm/1100 mm
- 1 x shower curtain rail, 800 mm/1000 mm
- 2 x tube angle piece 90° for square shower tray
- 2 x ceiling support, 400 mm
- 3 x 10 shower curtain rings, white

14943 / 14944
Shower curtain PLAN uni*/PLAN stripes
100% Trevira, 80 g/m², shower-proof, fungicidal,
anti-bacterial, anti-static, washable at 30 °C,
can be disinfected at 60 °C (shrinkage rate 1-2%),
ironing possible (shrinkage 1-3%), tested for harmful
substances according to OEKO-Tex Standard 100
Colours: white, ecru, light grey, truffle,
truffle/white, anthracite, anthracite/white, black,
black/white
Full length: 1800, 2000 mm
Width: 1400, 2000, 3000 mm

Surface chrome-plated
Surface aluminium silver anodized (E6 EV1) or aluminium finish
Surface stainless steel or stainless steel finish

14943 / 14944
Shower curtain PLAN Flame CS*
highly flame resistant according to DIN 4102/B1
100% Trevira, 80 g/m², shower-proof, fungicidal,
anti-bacterial, anti-static, washable at 30 °C,
can be disinfected at 60 °C (shrinkage rate 1-2%),
ironing possible (shrinkage 1-3%), tested for harmful
substances according to OEKO-Tex Standard 100
Colour: off-white
Full length: 1800, 2000 mm
Width: 1400, 2000, 3000 mm

14946 / 14947 / 34948
Shower curtain PLAN maxx*
100% polyester, 75 g/m², shower-proof, fungicidal,
anti-bacterial, washable at 30 °C
(Shrinkage rate 3%), ironing possible
(shrinkage 1-3%), tested for harmful substances
according to OEKO-Tex Standard 100
Colour: white
Full length: 670, 1800, 2000 mm
Width: 1400, 1800, 2000, 3000 mm

14945
Shower curtain PLAN*
all sizes are custom made.
Please specify: material, colour,
full length and width

***Notes on production characteristics:**
Vertical seams, reinforced stainless steel eyelets,
distance between the eyelets approx. 20 cm,
roll hem stainless steel weighted, 50 g per metre,
complete with curtain rings, white.

Notes on sizes: The sizes indicated are the sizes
of the finished curtain. To prevent the curtain from
touching the ground we recommend a distance from
curtain to floor of approx. 30 mm. Distance between
the middle of the curtain rod and the upper edge of
the curtain approx. 40 mm. The width of the curtain
should be approx. 1.3 to 1.5 times the length of the
shower curtain rod.



34940

34940
Spray guard
to be hooked on rail system or grab rails
complete with shower curtain PLAN maxxii
(670 x 800 mm)



34910

34910
Hand shower bracket
for shower rail, height adjustable



34912

34912
Hand shower sliding rail
complete with shower bracket
900, 1100 mm



34901

34901
Grab bar / Towel rail (USA)
for horizontal or vertical installation
300, 400, 500, 600, 700, 800, 900, 1000, 1100 mm



34907

34907
Angle bar 135°
may be used on the left or right
300, 400 mm

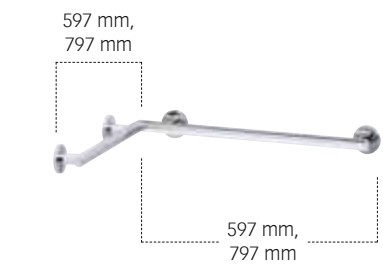

34911

34911
Corner rail for shower/bath
usable on left or right
Dimensions (w x h):
400 x 400 mm
400 x 600 mm
600 x 600 mm



34906

34906
Angle bar 90°
complete with shower bracket
usable as shower rail on left or right
Dimensions (w x h): 400 x 1100 mm



34906

34906
Angle bar 90°
usable on left or right
Dimensions (w x h): 300 x 600 mm

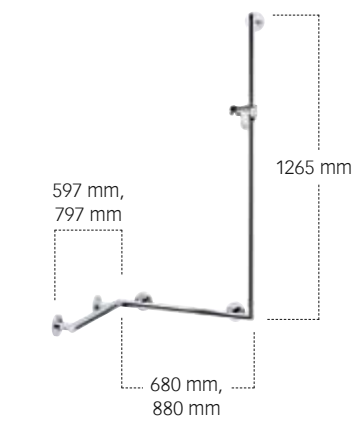

34908

34908
Rail system
complete with shower bracket
usable on left or right
Dimensions (w x h x d):
400 x 400 x 1100 mm
400 x 600 x 1100 mm
600 x 400 x 1100 mm
600 x 600 x 1100 mm



34914

34914
Rail system
complete with shower bracket
shower rail flexible positioning of sliding rail
prior to final installation
Dimensions (w x h x d):
600 x 600 x 1100 mm
600 x 900 x 1100 mm
900 x 600 x 1100 mm
900 x 900 x 1100 mm
900 x 1100 x 1100 mm
1100 x 900 x 1100 mm

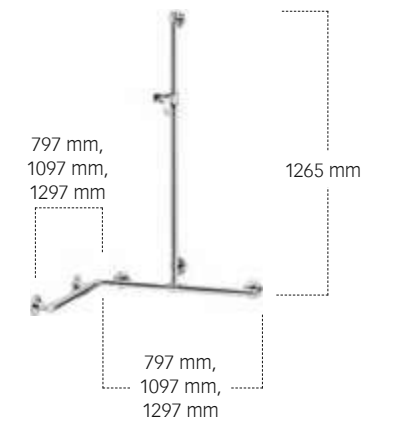

34915

34915
Rail system
complete with shower bracket
shower rail flexible positioning of sliding rail
prior to final installation
Dimensions (w x h x d):
600 x 600 x 1100 mm
600 x 900 x 1100 mm
900 x 600 x 1100 mm
900 x 900 x 1100 mm
900 x 1100 x 1100 mm
1100 x 900 x 1100 mm

Colour variations

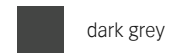

dark grey



light grey



white



34979



34983



34981



34982

34979
Back rest
for use on WC,
consists of wall rail (600 mm)
and back rest

34983
Tip-up seat
for wall mounting
tip-up seat,
seat size 450 mm wide

Surface chrome-plated or aluminium lacquer

34981
Tip-up seat with back rest
for hanging in handles as well as shower
and bath tub handles, tip-up seat,
seat size 360 mm wide

34982
Tip-up seat with back rest
for wall mounting
tip-up seat,
seat size 360 mm wide

Surface chrome-plated
Surface aluminium silver anodized (E6 EV1) or aluminium finish

Colour variations pivoted supporting rail



dark grey



light grey



white



34902



34903



34904



34905



34902



34962



34964

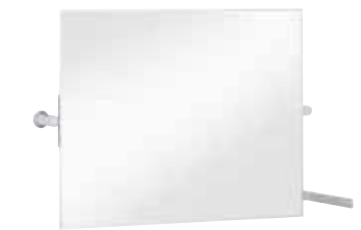

34986

34902
Pivoted supporting rail for wash basin
lifts up,
braked version,
with synthetic covered support
Projection: 650 mm

34904
Supporting rail for wash basin
fixed,
with synthetic covered support
Projection: 450/650 mm

34903
Pivoted supporting rail for WC*
lifts up,
braked version,
with synthetic covered support,
removable toilet paper holder with rollbrake
Projection: 700/850 mm

34905
Supporting rail for WC*
fixed,
with synthetic covered support,
removable toilet paper holder with rollbrake
Projection: 700/850 mm

34902
Cover plate
for fastening holes for supporting rails
and pivoted supporting rails

34962
Toilet paper holder
for mounting on an angle bar

34964
Toilet brush set
complete with synthetic insert,
brush with extended handle and
spare brush head

34986
Tilttable mirror
also suitable for installation with wall offset
Dimensions (w x h): 600 x 540 mm

*also with integrated WC flushing mechanism (right/left) for Geberit, Grohe, Sanit, Tece and Viega



52702



52704



52709



52726



51645



52724



52720



52772



52771



52773



52774

52702
Single lever basin mixer 120
 with/without pop-up waste 1 1/4 Inch,
 1-hole installation, cartridge mixer
 with ceramic sealing gaskets
 aerator SLIM SSR M 24 x 1,
 adjustable flow angle
 Flow rate limited to 6 l/min.

52704
Single lever basin mixer 100
 with/without pop-up waste 1 1/4 Inch,
 1-hole installation, cartridge mixer
 with ceramic sealing gaskets
 aerator SLIM SSR M 24 x 1,
 adjustable flow angle
 Flow rate limited to 6 l/min.

52709
Single lever bidet mixer
 with pop-up waste 1 1/4 Inch,
 1-hole installation, cartridge mixer
 with ceramic sealing gaskets
 aerator cache TT M 18,5 x 1
 flow rate limited to 6 l/min.

52726
Thermostat battery for shower
 exposed fitting
 handle with 50% water consumption regulation,
 safety cut-off at 38°C,
 with backflow preventer

51645
Bath filler/spout DN 20
 suitable for all concealed fittings
 Projection: 173, 223 mm

52724
Single lever shower mixer DN 15
 exposed fitting
 cartridge mixer with ceramic sealing gaskets,
 with backflow preventer

52720
Single lever bath tub mixer
 exposed fitting
 cartridge mixer with ceramic sealing gaskets
 and automatic diverter, with backflow preventer

52772
Single lever bath tub and shower mixer
 concealed fitting
 with/without safety device
 set complete with: handle, sleeve, diverter,
 rosette and installation unit
 suitable for rough part no. 59970 (Flexx Boxx)
 (Flexx Boxx to be ordered separately)

52771
Single lever shower mixer
 concealed fitting
 set complete with: handle, sleeve, rosette
 and installation unit
 suitable for rough part no. 59970 (Flexx Boxx)
 (Flexx Boxx to be ordered separately)

52773/52774
Thermostat battery
 concealed fitting
 with ceramic cut-off valve (52773),
 with ceramic cut-off and switch valve (52774),
 safety cut-off at 38°C,
 set complete with: handle, sleeve, diverter,
 rosette and installation unit
 suitable for rough part no. 59970 (Flexx Boxx)
 (Flexx Boxx to be ordered separately)



51686 / 51688



51686 / 51689



54995



12701

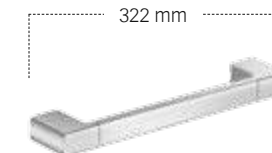

12707



52785

52787



51680



54941



12710



12713



12715



54991

59991



54947



12718 / 12719



12720 / 12722



12721

51686 / 51688
Overhead shower with wall outlet DN 15
 Ø 180 mm, with shower head rail,
 restricted flow rate 15 l/min.
 Projection: 300, 450 mm

51686 / 51689
Head shower with ceiling outlet DN 15
 Ø 180 mm, with shower head rail,
 restricted flow rate 15 l/min.
 Projection: 100, 300 mm

54995
Shower hose DN 15
 both ends fitted with conical nut
 and twist-protection
 1250, 1600, 2000 mm

12701
Towel rail
 400, 600, 800 mm

12707
Grab bar/Towel rail (USA)
 300 mm

12715
Towel hook

52785
Hand shower sliding rail
 consisting of:
 – wall rail, 900 mm
 – sliding bracket for shower head
 – height adjustment via handle,
 tilting angle adjustable
 – spacer disc (5 mm)

51680
Hand shower
 with anti limescale device
 Functions:
 – normal jet
 – soft jet

54941
Exposed part for angle valve DN 15/DN 20
 complete with: handle, sleeve, rosette
 and adjustable extension
 (Angle valve DN 15/DN 20
 to be ordered separately)

12710
Shelf
 with crystalline glass shelf
 Dimensions (w x h x d):
 500 x 120 mm
 650 x 120 mm
 800 x 120 mm
 1000 x 120 mm
 1300 x 120 mm

12713
Towel hook
 double

12721
Towel ring

52787
Hand shower sliding rail set
 consisting of:
 – wall rail, 900 mm
 – sliding bracket for shower head
 – height adjustment via handle,
 tilting angle adjustable
 – spacer disc (5 mm)
 – hand shower with normal jet and soft jet
 – shower hose, 1600 mm

54991
Wall bracket for hand shower
 for shower hoses with conical nuts

59991
Wall bracket for hand shower
 for shower hoses with conical nuts,
 with adjustable tilt angle 20-65°
 Projection: 97 mm

54947
Wall outlet for shower hose DN 15
 suitable for all concealed fittings

12718 / 12719
Towel holder
 2-arms, fixed
 Projection: 340, 450 mm

12720 / 12722
Towel holder
 1-arm, fixed
 Projection: 340, 450 mm



12750



12752



12755



12757



12758



12759



12760



12762



12763



12764



12769



04969



12785



12788

12750
Tumbler holder
complete with crystal glass tumbler

12757
Shower basket for corner
metal basket with removable insert
in white or anthracite
Dimensions (w x h x d): 180 x 180 x 80 mm

12752
Lotion dispenser
with plastic cup, matt
in white or anthracite
Capacity: approx. 180 ml

12758
Shower basket
metal basket with removable insert
in white or anthracite
Dimensions (w x h x d): 240 x 110 x 80 mm

12755
Soap holder
complete with crystal glass dish

12759
Shower basket
metal basket with removable insert
in white or anthracite
with integrated glass scraper
Dimensions (w x h x d): 240 x 110 x 91 mm

12760
Toilet paper holder
with lid,
for 100 mm wide paper rolls

12762
Toilet paper holder
open form,
for 120 mm wide paper rolls

12763
Spare paper holder

12764
Toilet brush set
with lid,
synthetic insert, brush with handle
and spare brush head
in white or anthracite

12769
Toilet brush set
with lid,
synthetic insert, brush with handle
and spare brush head
in white or anthracite

12785
Paper towel dispenser
wall mounted
in white or anthracite
with mirror door

04969
Toilet brush set
standing model,
synthetic insert, brush with handle
and spare brush head
in white or anthracite

12788
Waste bin
wall mounted
in white or anthracite
Capacity: approx. 25 l

SINGLE LEVER MIXER



1 WATER DRAW-OFF POINT

Wall outlet for shower hose



Wall outlet for shower hose with hand shower bracket



2 WATER DRAW-OFF POINTS

2-way diverter valve



2-way diverter valve with wall outlet for shower hose



2-way diverter valve with wall outlet for shower hose and hand shower bracket



3 WATER DRAW-OFF POINTS

3-way diverter valve



3-way diverter valve with wall outlet for shower hose



3-way diverter valve with wall outlet for shower hose and hand shower bracket



THERMOSTAT



1 WATER DRAW-OFF POINT

Stop valve



Stop valve with wall outlet for shower hose



Stop valve with wall outlet for shower hose and hand shower bracket



2 WATER DRAW-OFF POINTS

2-way diverter valve



2-way diverter valve with wall outlet for shower hose



2-way diverter valve with wall outlet for shower hose and hand shower bracket



2-way stop and diverter valve



2-way stop and diverter valve with wall outlet for shower hose



2-way stop and diverter valve with wall outlet for shower hose and hand shower bracket



3 WATER DRAW-OFF POINTS

3-way diverter valve



3-way diverter valve with wall outlet for shower hose



3-way diverter valve with wall outlet for shower hose and hand shower bracket



3-way stop and diverter valve



3-way stop and diverter valve with wall outlet for shower hose



3-way stop and diverter valve with wall outlet for shower hose and hand shower bracket





59551
Single lever mixer DN 15
Mixing cartridge with ceramic sealing gaskets, temperature controlled, set complete with:
handle, sleeve, rosette (round or square) and installation unit,
suitable for rough part no. 59551/000070



59551
Installation unit for single lever mixer DN 15
Rough part for recessed installation



59553
Thermostat battery DN 15
Set complete with:
handle, sleeve and rosette (round or square)
suitable for rough part no. 59553/000070



59553
Installation unit for thermostat battery DN 15
Rough part for recessed installation



59556
2-way diverter valve DN 15
Set complete with:
handle, casing, rosette (round or square) and diverter valve
suitable for rough part no. 59556/000070



59556
Installation unit for 2-way diverter valve DN 15
Rough part for recessed installation



59547
Wall outlet for shower hose DN 15
with round or square decorative disc,
intrinsicly safe against backflow
Projection: 55 mm



59556
2-way diverter valve with wall outlet for shower hose DN 15
Set complete with:
handle, casing, rosette (round or square) and diverter valve,
intrinsicly safe against backflow,
suitable for rough part no. 59556/000170



59556
Installation unit for 2-way diverter valve with wall outlet for shower hose DN 15
Rough part for recessed installation



59592
Wall outlet for shower hose with hand shower bracket DN 15
for shower hoses with fitted conical end brackets,
with round or square decorative disc,
intrinsicly safe against backflow



59556
2-way diverter valve with wall outlet for shower hose and hand shower bracket DN 15
Set complete with:
handle, casing, rosette (round or square) and diverter valve,
intrinsicly safe against backflow,
suitable for rough part no. 59556/000170



59556
Installation unit for 2-way diverter valve with wall outlet for shower hose DN 15
Rough part for recessed installation



59541
Stop valve DN 15
Set complete with:
handle, casing, rosette (round or square) and stop cock
suitable for rough part no. 59541/000070



59541
Installation unit for stop valve DN 15
Rough part for recessed installation



59557
2-way stop and diverter valve DN 15
Set complete with:
handle, casing, rosette (round or square) and stop and diverter valve
suitable for rough part no. 59556/000070



59556
Installation unit for 2-way diverter valve DN 15
Rough part for recessed installation



59541
Stop valve with wall outlet for shower hose DN 15
Set complete with:
handle, casing, rosette (round or square) and stop cock,
intrinsicly safe against backflow,
suitable for rough part no. 59541/000170



59541
Installation unit for stop valve with wall outlet for shower hose DN 15
Rough part for recessed installation



59557
2-way stop and diverter valve with wall outlet for shower hose DN 15
Set complete with:
handle, casing, rosette (round or square) and stop and diverter valve,
intrinsicly safe against backflow,
suitable for rough part no. 59556/000170



59556
Installation unit for 2-way diverter valve with wall outlet for shower hose DN 15
Rough part for recessed installation



59541
Stop valve with wall outlet for shower hose and hand shower bracket DN 15
Set complete with:
handle, casing, rosette (round or square) and stop cock,
intrinsicly safe against backflow,
suitable for stop cock no. 59541/000170



59541
Installation unit for stop valve with wall outlet for shower hose DN 15
Rough part for recessed installation



59557
2-way stop and diverter valve with wall outlet for shower hose and hand shower bracket DN 15
Set complete with:
handle, casing, rosette (round or square) and stop and diverter valve,
intrinsicly safe against backflow,
suitable for rough part no. 59556/000170



59556
Installation unit for 2-way diverter valve with wall outlet for shower hose DN 15
Rough part for recessed installation



59548
3-way diverter valve DN 15
 Set complete with:
 handle, casing, rosette (round or square) and diverter valve
 suitable for rough part no. 59548/000070



59548
Installation unit for
3-way diverter valve DN 15
 Rough part for recessed installation



59548
3-way diverter valve with wall outlet for shower hose DN 15
 Set complete with:
 handle, casing, rosette (round or square) and diverter valve,
 intrinsically safe against backflow,
 suitable for rough part no. 59548/000170



59548
Installation unit for
3-way diverter valve with wall
outlet for shower hose DN 15
 Rough part for recessed installation



59548
3-way diverter valve with wall outlet for shower hose
and hand shower bracket DN 15
 Set complete with:
 handle, casing, rosette (round or square) and diverter valve,
 intrinsically safe against backflow,
 suitable for rough part no. 59548/000170



59548
Installation unit for
3-way diverter valve with wall
outlet for shower hose DN 15
 Rough part for recessed installation



59549
3-way stop and diverter valve DN 15
 Set complete with:
 handle, casing, rosette (round or square) and stop and diverter valve
 suitable for rough part no. 59548/000070



59548
Installation unit for
3-way diverter valve DN 15
 Rough part for recessed installation



59549
3-way stop and diverter valve with wall outlet
for shower hose DN 15
 Set complete with:
 handle, casing, rosette (round or square) and stop and diverter valve,
 intrinsically safe against backflow,
 suitable for rough part no. 59548/000170



59548
Installation unit for
3-way diverter valve with wall
outlet for shower hose DN 15
 Rough part for recessed installation



59549
3-way stop and diverter valve with wall outlet for shower hose
and hand shower bracket DN 15
 Set complete with:
 handle, casing, rosette (round or square) and stop and diverter valve,
 intrinsically safe against backflow,
 suitable for rough part no. 59548/000170



59548
Installation unit for
3-way diverter valve with wall
outlet for shower hose DN 15
 Rough part for recessed installation



EDITION 11



EDITION 400



EDITION 300



ELEGANCE



COLLECTION MOLL



PLAN



PLAN Blue



59551

59551
Single lever mixer/handles
 handles matching the recessed
 single lever mixers no. 59551/019501,
 59551/019502

59541 / 59556 / 59557 / 59548 / 59549

Handle IXMO Comfort Plus
 for all stop and diverter valves,
 with adjustment facilities for
 twisted recessed wall installation
 of the basic unit

59541 – for stop valves
59556 – for 2-way diverter valves
59557 – for 2-way stop and diverter valves
59548 – for 3-way diverter valves
59549 – for 3-way stop and diverter valves

Note:
 for the vertical alignment of the handle



59545

59545
Bath filler/spout DN 15
 with round or square rosette,
 suitable for all concealed fittings
 Projection: 130, 180 mm



59547

59547
Universal installation unit G 1/2
 for an easy fitting of products with 1/2 inch connection in combination with mounting rail, internal thread G 1/2

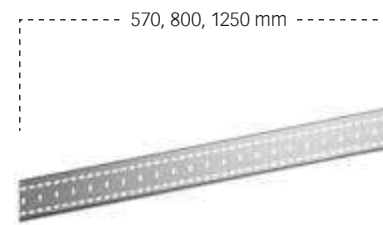

59570

59570
IXMO Mounting rail
 for an easy and steplessly adjustable installation of the IXMO function units
 Length: 570, 800, 1250 mm



59553

59553
Extension rosette
 25 mm, round or square, brass, for installation between tiles and finish set for installation of stop and diverter valve in walls with a low wall thickness, installation depth 55-80 mm, suitable for rough part art. no. 59553 000070



59551

59551
Extension rosette
 25 mm, round or square, brass, for installation between tiles and finish set for installation of stop and diverter valve in walls with a low wall thickness, installation depth 55-80 mm, suitable for rough part art. no. 59541/000070, 59541/000170, 59548/000070, 59548/000170, 59556/000070, 59556/000170

59551
Extension rosette
 25 mm, round or square, brass, with red/blue marker, for installation between tiles and finish set for installation of stop and diverter valve in walls with a low wall thickness, installation depth 55-80 mm, suitable for rough part art. no. 59556/000070



59949

59949
Tube interrupter
 in accordance with DIN EN 1717 in a wall mounting box with chrome-plated cover (round)

Note:
 Behind the tube interrupter is no shutoff allowed. Installation only in a vertical position.

59949
Cover cap
 round (90 mm Ø) or square (90 x 90 mm), for tube interrupter article no. 59949/000070



59949



59551

59551
Extension set for single lever mixer
 30 mm (installation depth 110-140 mm), for base structure 59551/000070

59556
Extension set for stop and diverter valve
 30 mm (installation depth 110-140 mm), for base structure 59541/000070, 59556/000070, 59548/000070



59556



59553

59553
Extension set for thermostatic mixer
 30 mm (installation depth 110-140 mm), for base structure 59553/000070

59556
Extension set for stop and diverter valve with wall outlet for shower hose
 30 mm (installation depth 110-140 mm), for base structure 59541/000170, 59556/000170, 59548/000170



59556

Glass colour variations

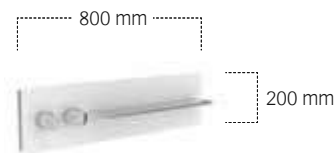
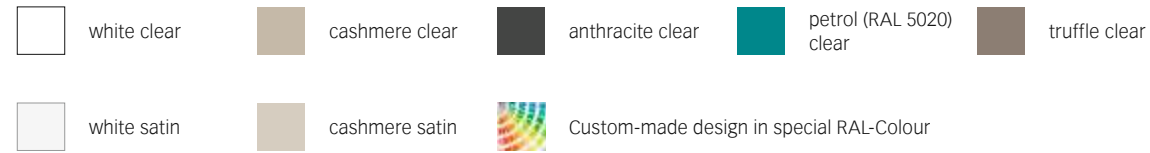

56161

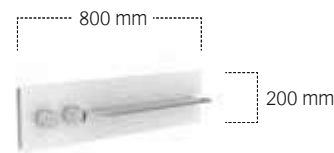

56162

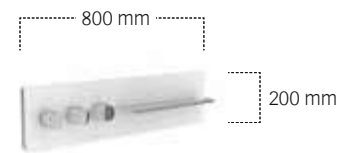

56163

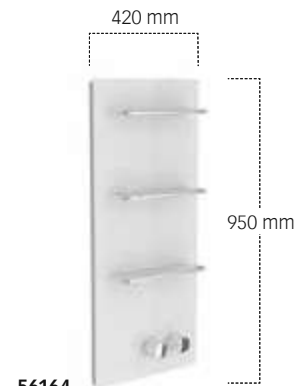

56164

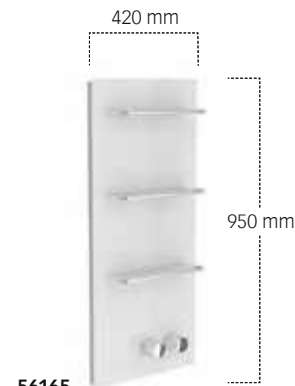

56165

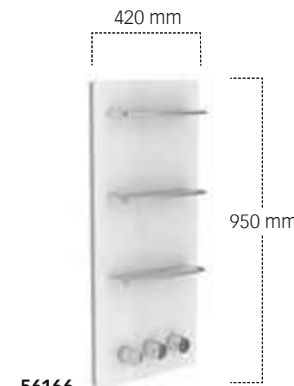

56166



59948



59982



59993



59996

56161
Shower and bathtub board with thermostat battery DN20
 Finish set for the regulation of 1 user handles as desired left or right complete with:
 – Mounting frame
 – Panel made of ESG glass, with frame and one shelf made of aluminium
 – Knob for thermostat with safety cut-off at 38 °C
 – Shut-off handle
 Dimensions (w x h): 800 x 200 mm (essential for installation: rough part article no. 56161 000071 to be ordered separately)

56162
Shower and bathtub board with thermostat battery DN20
 Finish set for the regulation of 2 users handles as desired left or right with/without safety device complete with:
 – Mounting frame
 – Panel made of ESG glass, with frame and one shelf made of aluminium
 – Knob for thermostat with safety cut-off at 38 °C
 – Shut-off and adjustment handle
 Dimensions (w x h): 800 x 200 mm (essential for installation: rough part article no. 56162 000072 to be ordered separately)

56163
Shower and bathtub board with thermostat battery DN20
 Finish set for the regulation of 3 users handles as desired left or right complete with:
 – Mounting frame
 – Panel made of ESG glass, with frame and one shelf made of aluminium
 – Knob for thermostat with safety cut-off at 38 °C
 – Shut-off handle
 – Adjustment grip
 Dimensions (w x h): 800 x 200 mm (essential for installation: rough part article no. 56163 000073 to be ordered separately)

56164
Shower board with thermostat battery DN20
 Finish set for the regulation of 1 user handles right, complete with:
 – Mounting frame
 – Panel made of ESG glass, with frame and three shelves made of aluminium
 – Knob for thermostat with safety cut-off at 38 °C
 – Shut-off handle
 Dimensions (w x h): 420 x 950 mm (essential for installation: rough part article no. 56161 000071 to be ordered separately)

56165
Shower board with thermostat battery DN20
 Finish set for the regulation of 2 users handles right, complete with:
 – Mounting frame
 – Panel made of ESG glass, with frame and three shelves made of aluminium
 – Knob for thermostat with safety cut-off at 38 °C
 – Shut-off and adjustment handle
 Dimensions (w x h): 420 x 950 mm (essential for installation: rough part article no. 56162 000072 to be ordered separately)

56166
Shower board with thermostat battery DN20
 Finish set for the regulation of 3 users handles right, complete with:
 – Mounting frame
 – Panel made of ESG glass, with frame and three shelves made of aluminium
 – Knob for thermostat with safety cut-off at 38 °C
 – Shut-off handle
 – Adjustment grip
 Dimensions (w x h): 420 x 950 mm (essential for installation: rough part article no. 56163 000073 to be ordered separately)

59948
Exposed part for 3-way diverter valve UP
 complete with:
 handle, sleeve, rosette (round/square)

59982
Waterfall shower
 for wall connection G 1/2 Inch restricted flow rate 25 l/min.

59993
Wall outlet for shower hose DN20
 with wall bracket, for SPA hose, suitable for all concealed fittings with backflow preventer

59996
SPA hose
 with chrome-plated shower bracket for wall connection elbow and chrome-plated hose connection 3/4"

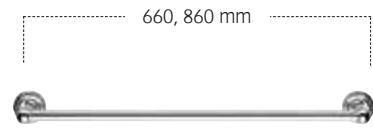

02101



02107



02110



02160



02163



02164



03864



02117

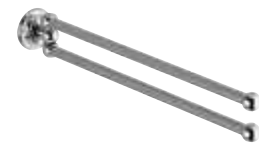

02118



02114/02116



02121

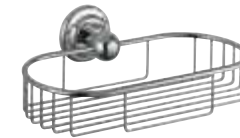

02158



02175



02191/02195



02150



02152



02153



02155



17621



17621



06541

02101
Towel rail
600, 800 mm

02107
Grab bar/Towel rail (USA)
300 mm

02110
Shelf
with crystalline glass shelf
Dimensions (w x h):
450 x 120 mm
650 x 120 mm

02160
Toilet paper holder
with lid

02164
Toilet brush set
complete with matt crystal glass insert and brush

03864
Toilet brush set
with lid,
complete with brush and spare brush head

02117
Towel holder
1-arm, fixed
Projection: 434 mm

02118
Towel holder
2-arms, swivelling
Projection: 465 mm

02114/02116
Towel hook
Robe hook

02163
Spare paper holder

02175
Towel rack
600 mm

02191
Wall decor disk
chrome-plated, gold-plated

02150
Tumbler holder
complete with crystal glass tumbler

02152
Lotion dispenser
complete with opal glass, matt
Capacity: approx. 160 ml

02121
Towel ring
Ø 175 mm

17621
Cosmetic mirror
non illuminated, on wall rail,
adjustable in three dimensions,
mirror single sided, concave,
magnification factor x 5, Ø 212 mm

17621
Cosmetic mirror
illuminated, on wall rail,
adjustable in three dimensions,
mirror single sided, concave,
power supply with adapter (100-240 V)
spiral cord (400 mm) and cable switch
Lighting: 1 x 4.5 Watt LED
(maintenance-free lamps)
Light colour: 6000 kelvin (daylight)
magnification factor x 5, Ø 212 mm

02195
Wall decor disk
to wall light ASTOR chrome-plated, gold-plated

02153
Lotion dispenser
complete with opal glass, matt
Capacity: approx. 250 ml

02155
Soap holder
complete with crystal glass dish

06541
Wall light
with opal glass, matt, 1 x 40 W E14



02701



02703

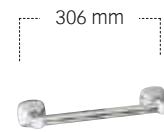

02707



02710



02714



02715



02718



02755



02753



02760



02721



02750



02751



02762



02763



02764

02701
Towel rail
400, 600, 800 mm

02703
Towel rail
double
600 mm

02707
Grab bar / Towel rail (USA)
250 mm

02710
Shelf
with crystal glass shelf
Dimensions (w x h):
450 x 120 mm
650 x 120 mm

02714
Towel hook

02715
Towel hook

02718
Towel holder
2-arms, swivelling
Projection: 430 mm

02751
Double tumbler holder
complete with crystal or acrylic glass tumblers

02755
Soap holder
complete with crystal or acrylic glass dish

02762
Toilet paper holder
open form

02753
Lotion dispenser
complete with crystal glass, matt
Capacity: approx. 250 ml

02763
Spare paper holder

02760
Toilet paper holder
with lid

02764
Toilet brush set
complete with with synthetic insert,
brush and spare brush head



- | | | | | | |
|---|---|--|---|---|--|
| <p>14977
Sanitary waste bin
wall mounted
Capacity: 3 l</p> <p>04909
Grab bar / Towel rail (USA)
with soap holder and drainage slots</p> <p>11649
Soap dispenser
for mounting on washbasin or washbasin worktop, including foam soap (2 x 500 ml), also available for liquid soap
Capacity: approx. 500 ml
Height: 93 mm</p> | <p>04988
Waste bin
with detachable black insert
Capacity: 5 l</p> <p>14949
Built in soap dispenser
for mounting on washbasin or washbasin worktop
Capacity: approx. 500 ml</p> <p>04960
Toilet paper holder
for wall mounting</p> | <p>04979
Clothes line
complete with wall mounting element
extendable up to max. 2.80 m</p> <p>14952
Lotion dispenser standing model
Capacity: approx. 250 ml</p> <p>04972
Guest towel basket</p> | <p>11650
Tumbler holder
table model
complete with crystal glass tumbler, matt</p> <p>11667
Moisture box
comes with porcelain box, white</p> | <p>11653
Foam soap dispenser
table model
opal glass, matt
including foam soap (2 x 500 ml)
Capacity: approx. 220 ml</p> <p>11654
Lotion dispenser
table model
opal glass, matt
Capacity: approx. 220 ml</p> <p>04975
Towel rack
650 mm</p> <p>04976
Hygiene bag dispenser
ABS plastic for max. 25 bags,
including first 25 bags</p> | <p>11655
Soap holder
table model
complete with removable crystal glass dish, matt</p> <p>04983
Towel rack
3 pronged, complete with towel hook,
610 mm</p> <p>04977 / 04985
Tissue box
with closed sides, for up to max. 150 sheets</p> |
|---|---|--|---|---|--|



01680



14982



11682



14995



04996 / 04997



14966-14971



11170



30070



03864



04969



16052

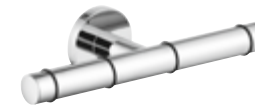

16062



11172



12769



16064

01680
Tip-up seat
with Keucolit-seat, white

14995
Hair dryer
with wall mounting element, 230 V
Features:
– On-off switch with indicator light on the wall holder
– 3 heating levels up to max. 1800 W
– 2 speed levels
– Cold air button
– Overheating protection

14982
Bathroom stool
also suitable for wet rooms
seat white, dark grey or light grey
Surface chrome-plated
or aluminium silver anodized (E6 EV1)

04996 / 04997
Hair dryer holder
usable on left or right

11682
Bathroom stool
chrome-plated, walnut veneer

14966
Doorplate
Symbol Ladies

14967
Doorplate
Symbol Gents

14968
Doorplate
Symbol Disabled

14971
Doorplate
Symbol Ladies/Gents

11170
Towel holder
holds 6 guest towels
(approx. 30 x 50 cm)

30070
Towel holder
holds 6 guest towels
(approx. 30 x 50 cm)

16052
Soap dispenser
table model
including foam soap (2 x 500 ml)
Capacity: approx. 150 ml
Height: 195 mm

16062
Toilet paper double holder
for 100/120 mm wide paper rolls

03864
Toilet brush set
with lid,
complete with brush and spare brush head

04969
Toilet brush set
standing model, with lid,
complete with synthetic insert,
brush with handle and spare brush head
in white or anthracite

11172
Guest towel basket
removable,
MDF white lacquered
Dimensions (w x h x d): 200 x 350 x 200 mm

12769
Toilet brush set
with lid,
synthetic insert, brush with handle
and spare brush head
in white or anthracite

16064
Toilet brush set
standing model,
complete with glass insert, brush
and spare brush head



24901/24902

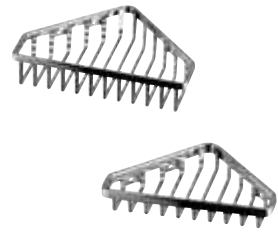

24903/24904



24941



24942



24943



24944

24901
Soap wire basket
Dimensions (w x h x d): 132 x 100 x 28 mm

24902
Sponge wire basket
Dimensions (w x h x d): 200 x 100 x 28 mm

24942
Sponge basket
removable, with concealed fastening screws
Dimensions (w x h x d):
200 x 114 x 28 mm
200 x 114 x 70 mm

24903
Soap wire basket for corner installation
Side length: 127 mm
Dimensions (w x h x d): 180 x 115 x 28 mm

24904
Sponge basket for corner installation
Side length: 170 mm
Dimensions (w x h x d): 240 x 170 x 50 mm

24943
Soap wire basket for corner installation
removable, with concealed fastening screws
Side length: 140 mm
Dimensions (w x h x d): 197 x 133 x 28 mm

24941
Soap wire basket
removable, with concealed fastening screws
Dimensions (w x h x d): 132 x 105 x 28 mm

24944
Sponge basket for corner installation
removable, with concealed fastening screws
Side length: 186 mm
Dimensions (w x h x d):
264 x 180 x 47 mm
260 x 180 x 72 mm



11657



11658



11158

11159



12757



12758



12759



11558



11559

11657
Sponge basket for corner installation
metal basket with removable insert
in white or anthracite
Dimensions (w x h x d): 180 x 180 x 70 mm

12757
Shower basket for corner
metal basket with removable insert
in white or anthracite
Dimensions (w x h x d): 180 x 180 x 80 mm

11558
Shower shelf
aluminium silver-anodized (E6 EV1)

11658
Sponge basket
metal basket with removable insert
in white or anthracite
Dimensions (w x h x d): 239 x 105 x 70 mm

12758
Shower basket
metal basket with removable insert
in white or anthracite
Dimensions (w x h x d): 240 x 110 x 80 mm

11559
Shower shelf
aluminium silver-anodized (E6 EV1)
with integrated glass scraper (white)

11158
Shower basket
aluminium silver anodized/chrome-plated
Dimensions (w x h x d): 300 x 95 x 67 mm

11159
Shower basket
aluminium silver anodized/chrome-plated
with integrated glass scraper
Dimensions (w x h x d): 300 x 95 x 67 mm

12759
Shower basket
metal basket with removable insert
in white or anthracite
with integrated glass scraper
Dimensions (w x h x d): 240 x 110 x 91 mm

The extraordinary surface characteristics and extremely fine colour nuances of our products can only be reproduced to a certain degree in print. Only the original KEUCO products, which can be viewed in sanitary trade dealers' showrooms, can provide you with an optimum impression.

Reproduction and copying, even if only excerpts, are only permitted by explicit permission of the manufacturer, and with the inclusion of source information.
KEUCO GmbH & Co. KG, Postfach 1365, D-58653 Hemer

We reserve the right to make engineering changes for the purpose of improvement, as well as colour and design changes that are deemed necessary. Errors and omissions excepted.

Our articles are sold exclusively through sanitary wholesale.

Concept, design, text and lithography: KONTRAST Communication Services GmbH, Düsseldorf
Photography: Christian Stoll, Düsseldorf; Thomas Krüsselmann, Viersen;
Markus Meuthen, Düsseldorf; Stephan Schacher, New York; Eva Gaida, Aalen;
Casa, Münster; provideo & fototeam, Menden
Printing: Meinders & Elstermann GmbH & Co. KG, Belm, Osnabrück
Printed on GALAXI Keramik. Supplied by Papier Union.

For more information please visit www.keuco.de