

Creative Healthcare Solutions



NEW

Featuring
ALL NEW
Elevate and
FreeGlide
half-height doors

impey

THE WETROOM SPECIALIST

Creative Healthcare Solutions 2017



Proudly working in partnership with



Leak free wetroom and level access showering for the Care market

Impey Showers was founded on providing specialist wetroom showering solutions for people with mobility difficulties, pioneering many of the product innovations that now lead the market. Our range of products include walk-in wetroom shower floors for vinyl floor coverings, low access shower trays, shower doors, support rails, shower seats and accessories.

We design innovative, high quality products for the health and care sectors and we work closely with contractors and installers; local authorities and healthcare professionals to provide innovative high quality wetroom solutions for all types of bathroom adaptation, improving the lives of thousands of people every year.

All products are created by our highly skilled team of designers, combining innovation and the highest quality materials. All backed up by the established and recognised Impey brand.

The UK's leading wetroom specialist

Contents

Why specify Impey?	4
Shower planning guide	6
Wetroom floor formers	8
Showertrays	18
Shower doors, shower panels and screens	38
Shower seats and grab rails	60
Drainage options for wetrooms and showertrays	78
Showers, pumped drainage options and accessories	82
Automatic shower toilets	94

Over 300,000 successful installations in the UK

Full technical support and training for installations

Lifetime Watertight Guarantee (on selected products)

LIFETIME GUARANTEE

For full details see back cover

Certified with Investor in People and to ISO 9001:2008 and ISO 14001:2004

Why specify Impey

Apart from our pride in being a UK manufacturer here are some reasons why Impey are the number one choice for specialist wetroom healthcare solutions.

Free on-site surveys

At Impey we believe in precision. Gathering all the right information on site at the earliest opportunity helps us create the ideal solution.

Innovations that make life easier

Innovations can be found everywhere across the Impey range; original ideas that redefine what's possible, adding value and bringing real installer and customer benefits.

Cost saving installation

Most of our products can be easily fitted by a single installer. Our carefully considered product design ensures minimal installation time.

Failsafe quality and reliability

We use only the best materials and rigorous construction methods to ensure the greatest quality and reliability.



Unbeatable customer service. Full technical support and training for all installations.

Unrivalled technical support

Every member of the sales team is fully qualified to advise on all aspects of our products and installation.

Unbeatable service

The home of the UK's leading wetroom floor former

Level-Dec Easyfit. Revolutionary design and unique to Impey

24 Hour delivery

All standard products can be dispatched and delivered within 24 hours with timed deliveries possible, POA. Special order products can be delivered within 3 to 5 days.

We have a dedicated Technical Helpline, which offers you instant access to our unmatched specialist knowledge.

Comprehensive, risk-free healthcare solutions

All Impey products conform to ISO 14001 re-enforcing our commitment to the environment

Environmental kudos

WE ARE THE UK'S NO.1 WETROOMS

With over 300,000 installations in the UK, Impey also export to the United States, France & Germany.



Shower planning guide

Step 1: Floor

Creating 100% level access on wood or concrete floors

For wood or solid floors

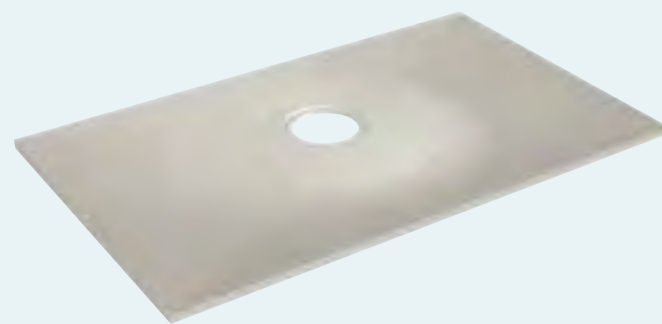

Level-Dec EasyFit Floor Former
Pages 10-13

For new concrete floors

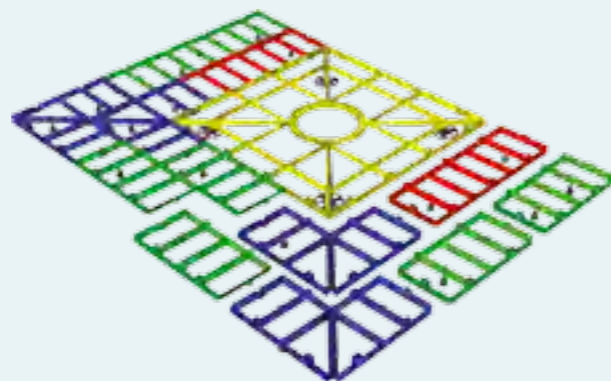

Level-Grade
Pages 14-15

Enabling showering on an unbreachable floor

Radiate



Radiate
Pages 20-23

Mendip

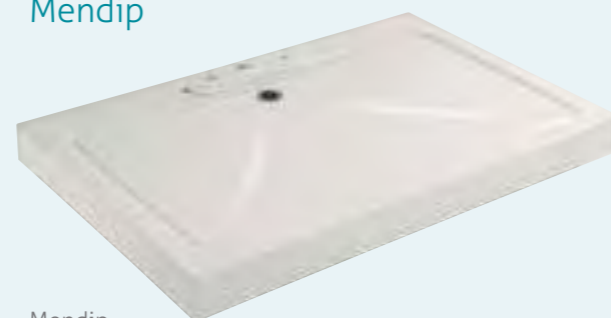

Mendip
Pages 24-27

Low level access Shower Trays

As an alternative to wetroom floor formers we offer a range of showertrays, which are available with sloping ramps to provide the easiest access.

Pages 28-36

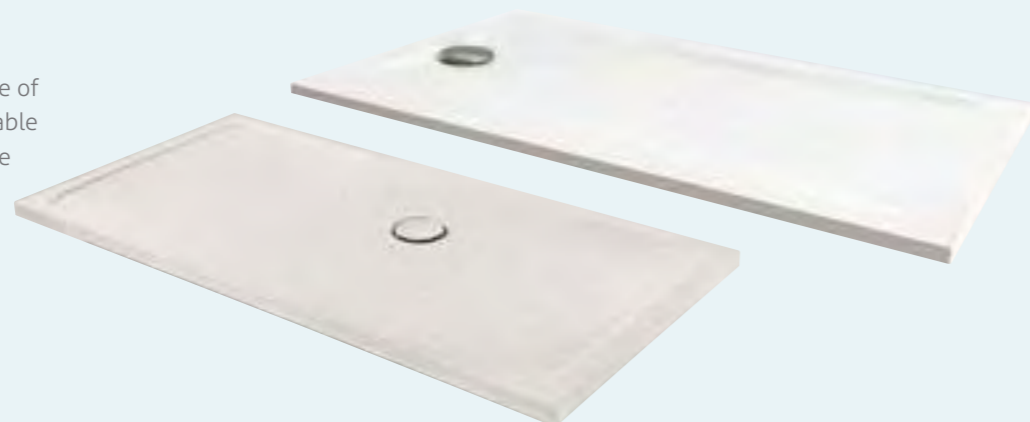

Step 2: Drainage

Waste fittings for gravity drainage are supplied as standard, but we also offer alternative waste fitting options including pumped drainage - see pages 78-81



For situations where the waste fitting cannot be recessed into the floor we have designed two shower trays where the waste fitting is housed within the height of the tray.

Pages 20-27



Step 3: Shower Doors & Glass Screens

Once you have selected the size of wetroom floor former or showertray you can then choose from a wide range of hinged folding or sliding doors, which can all be supplied left or right handed - see pages 38-45.



Step 4: Showers and Accessories

Personalise your showering space further by adding a shower seat or bench in a range of colours, modular grab rails to suit your space and a wide selection of thermostatic showers to best fit your requirements.

We offer a wide range of:

Curtain rails	Page 46
Shower seats	Pages 60-71
Grab rails	Pages 72-77
Drainage options	Pages 78-81
Showers	Pages 82-91
Pumped drainage	Pages 92-93



Creating 100% level access on concrete and wooden floors



Products featured include: Level-Dec EasyFit 1200 x 1200 floor former (LDE1212GRY) with UTVC01/H gravity waste. L shape curtain rail (SRL-120120W). Shower curtain (IC 2020). Shower Mira Advance Flex. Maxi-Grip Plus 450mm Grab rails (IGS45G). SlimFold seat Sandstone (SFS250WSS).

Level-Dec EasyFit

The UK's market leading wetroom floor former

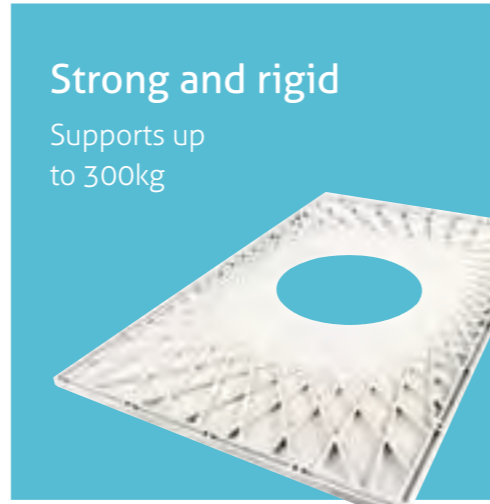

Strong and rigid
Supports up to 300kg

LIFETIME GUARANTEE

For full details see back cover

Created by Impey, our patented, Level-Dec EasyFit floor former has revolutionised wetroom installation and is not available from any other manufacturer. This is our tried and tested best selling Dec.

Level-Dec EasyFit wetroom floor formers are the easiest and most reliable way to create the gradient for efficient drainage in a wetroom floor.

They are ideal for wooden or concrete floors and are quick and easy to install, with the strength and rigidity to support up to 300kg, without the need to under board.*



- Quick and easiest former to install on the market
- Ideal for wooden or concrete floors
- No under boarding required*
- Easy to cut with a standard handsaw to fit your exact space requirements
- Easy to drill to provide additional screw fixing holes

*For joists under 415mm centre to centre spacing



Supplied with a UTVG01/H vinyl floor gully horizontal outlet as standard

Alternative drainage options available



Revolutionary 360 degree rotating drain

Makes installation even easier - the drainage point can be adjusted to avoid any joists and assist in linking up to existing drainage

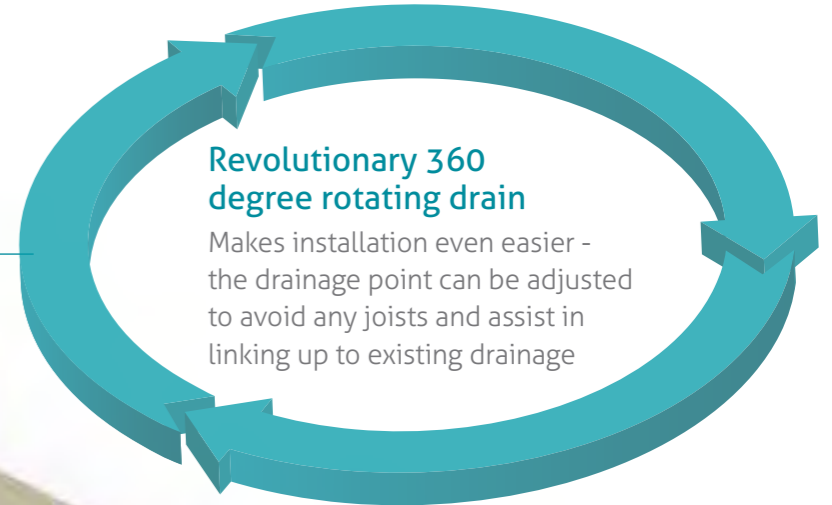

All Level-Dec's are 22mm thick

The overall thickness is the same depth as the most commonly used flooring materials - providing a level access finish

22mm

Level-Dec Easyfit for vinyl floors*

Flowrate up to 38 litres per minute depending on the room layout and the size of Level-Dec

The market leading wetroom floor former

- No under boarding required - tested to 300kg (47 Stone)
- Making installation even easier - the location of joists within timber floors no longer presents a problem, because the Level-Dec EasyFit includes a revolutionary drainage feature that allows the installer to rotate the drainage point through 360° to any position in order to avoid the joist
- Easy to cut and drill - If you need to trim or cut to avoid an obstruction it can be cut with a universal hand saw and drilled to provide additional screw fixing holes

All Level-Decs are 22mm thick at the outer rim to be the same depth as most commonly used flooring materials. Supplied with a UTVG01/H Vinyl Floor Gully Horizontal Outlet as standard, for alternative drainage see pages 70-73



For full details see back cover



Simply place the new Level-Dec EasyFit where it will be installed and if the drain aperture interferes with a joist, just rotate the centre section until it is clear and fit the trap.

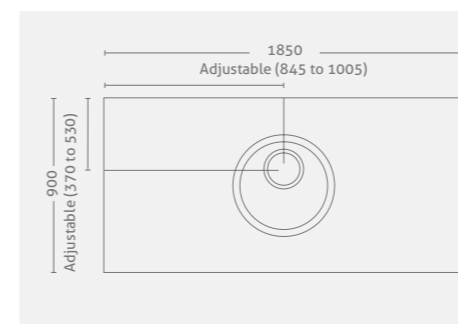
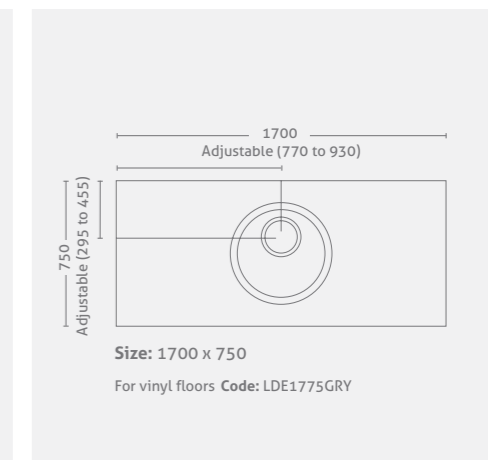
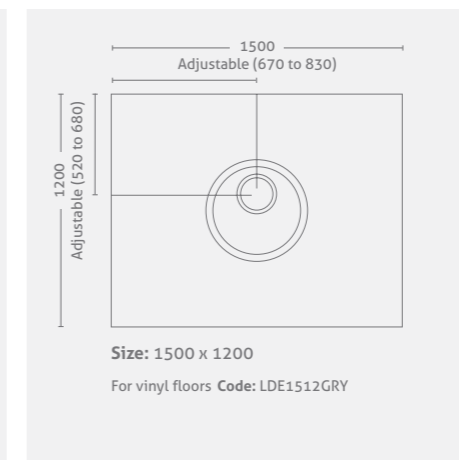
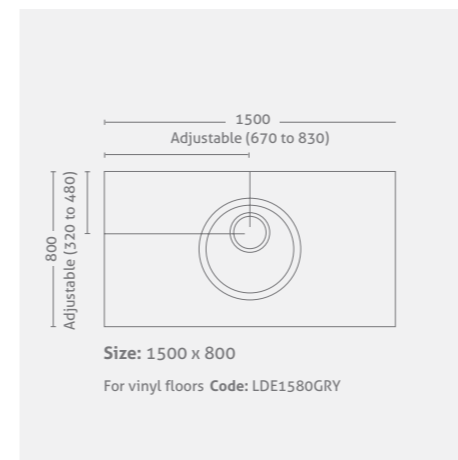
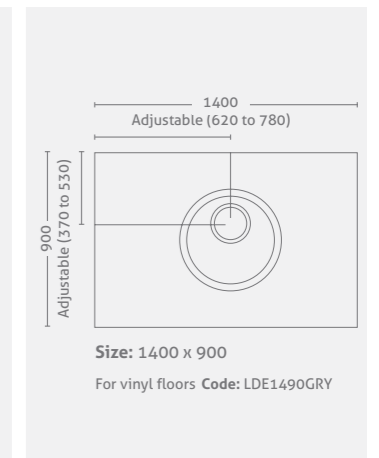
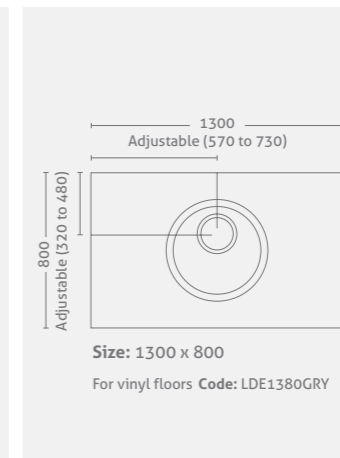
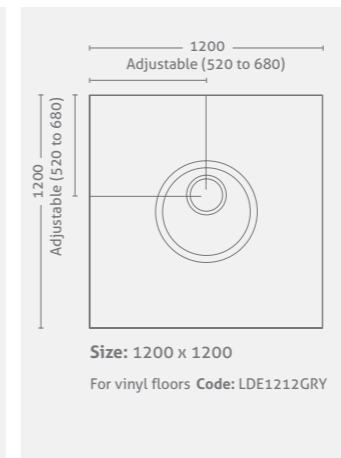
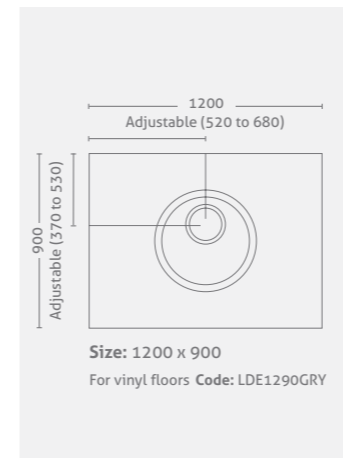
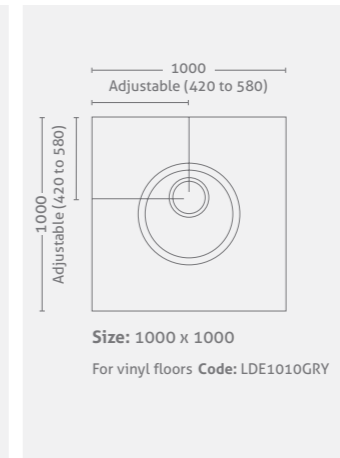
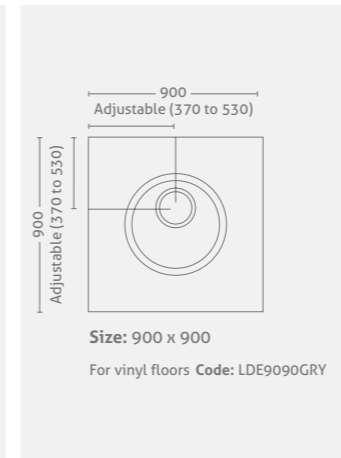
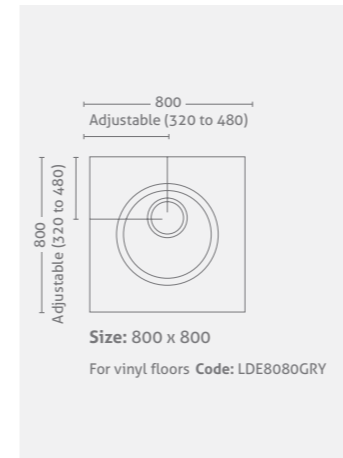

For full details see back cover

For tiled options see page 81

Level-Grade

The Alternative Solution

Level-Grade provides a quick and easy alternative way of creating the perfect wetroom floor gradient for concrete solid floors.

Colour coded modular sections quickly click together to form a matrix that you simply fill with screed.

- Precise and quick to use
- Ideal for new build projects where timing is critical
- Guarantees the perfect wetroom floor gradient every time
- Available in 8 standard sizes
- Endless bespoke options available
- Eliminates any chance of water pooling



Colour coded modular sections
Click together to form a matrix that creates the perfect wetroom gradient.

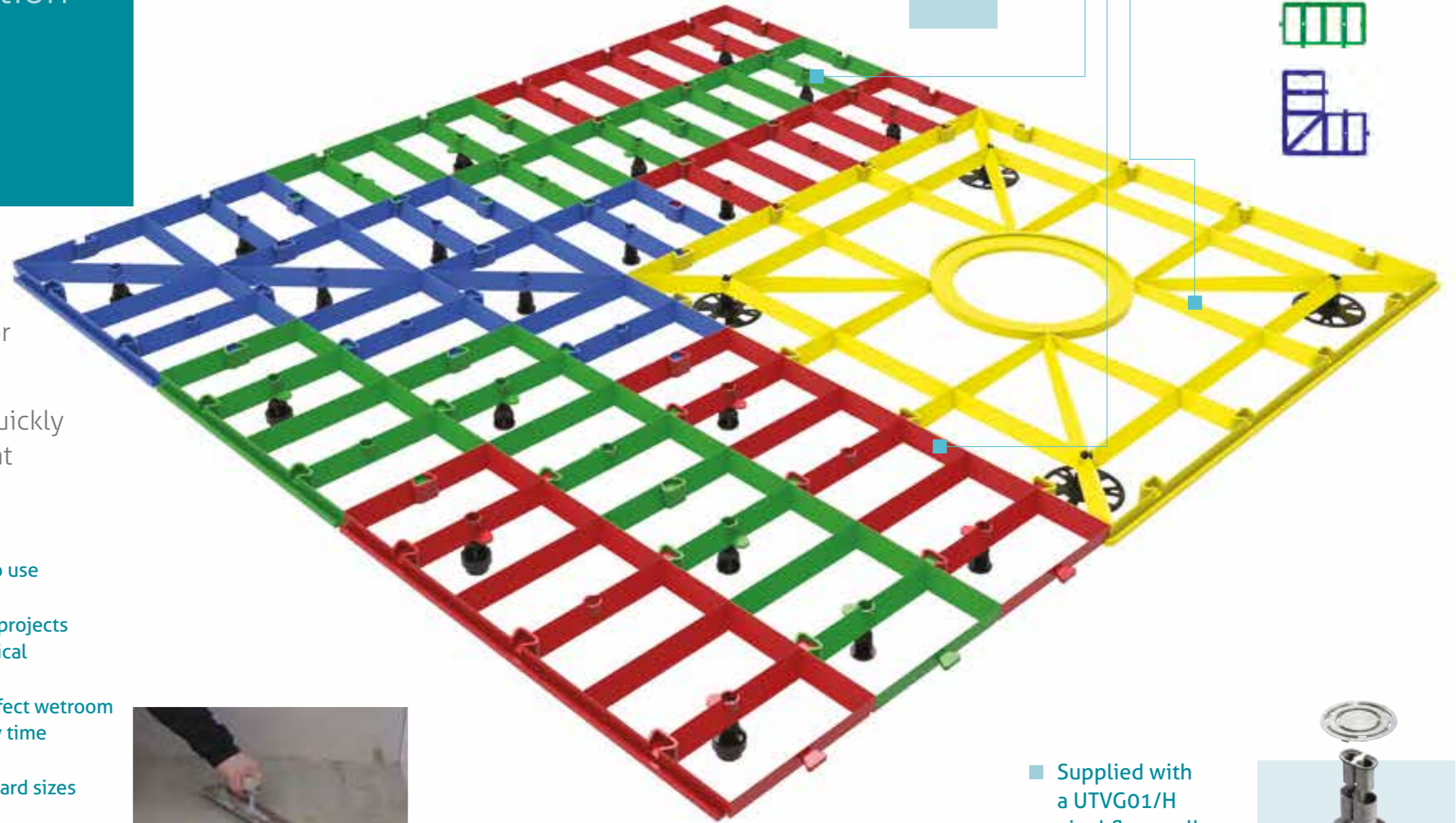
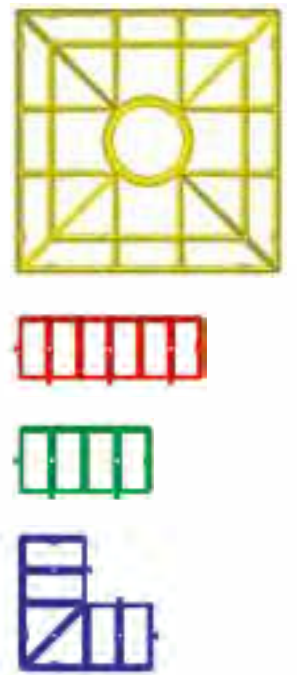

- Supplied with a UTVG01/H vinyl floor gully horizontal outlet as standard
Alternative drainage options available



Level-Grade - the alternative solution

The installation process



First you locate the 600mm square starter section and mark the position of the feet and waste trap.

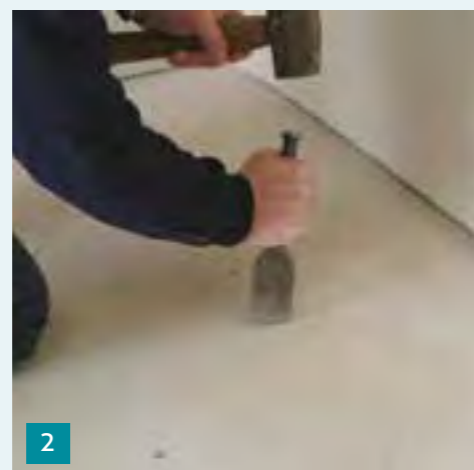

Chase out the sub-floor to accommodate the waste trap and pipe work.



Assemble and fit the remaining sections, ensuring that each section is level.



Fill the matrix with a fairly dry mixed screed and float over the surface so that the ridges of the Level-Grade are just visible.

Note: shuttering required when filling the screed area.



Standard sizes & bespoke options

Level-Grade is available in eight standard sizes (shown below), or we can provide bespoke options please call our technical advisory team on 01460 258682.

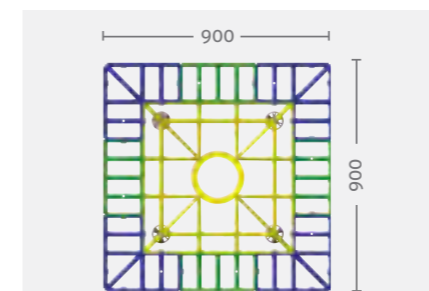

Size: 900 x 900mm
Code: LG9090

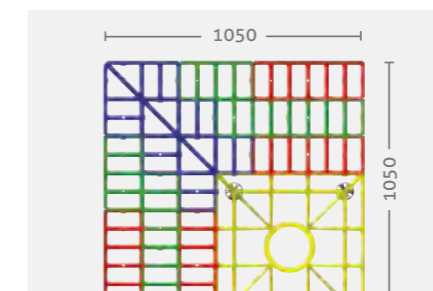

Size: 1050 x 1050mm
Code: LG105105

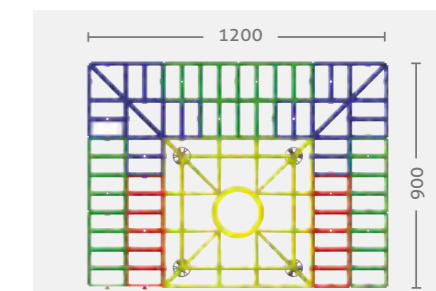

Size: 1200 x 900mm
Code: LG12090

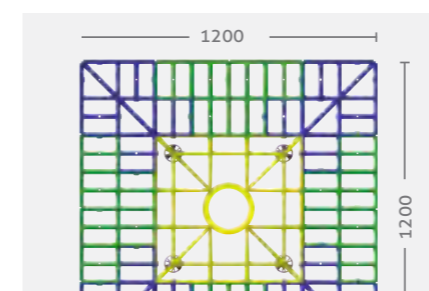

Size: 1200 x 1200mm
Code: LG120120

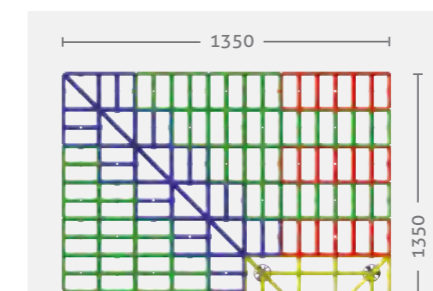

Size: 1350 x 1350mm
Code: LG135135

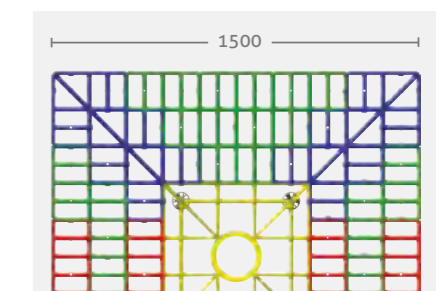

Size: 1500 x 1050mm
Code: LG150105

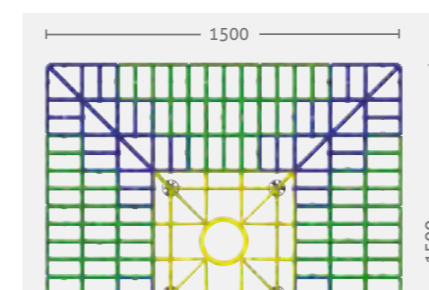

Size: 1500 x 1500mm
Code: LG150150

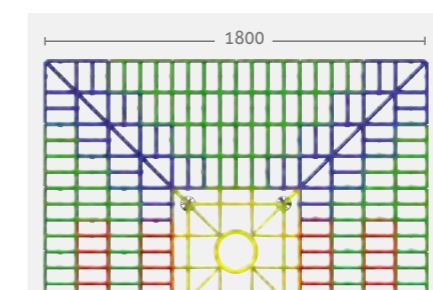

Size: 1800 x 1200mm
Code: LG180120

Please note that when installing you will need to refer to the fitting instructions, which are included in the pack.



All Level-Grade options are supplied as standard with the UTVG01/H floor gully with a horizontal outlet. Other drainage options are also available - see page 80.

The size options are endless with Level-Grade. Please call our technical team direct to configure a bespoke size on 01460 258682

Flowrate up to 38 litres per minute depending on the room layout and the size of Level-Grade

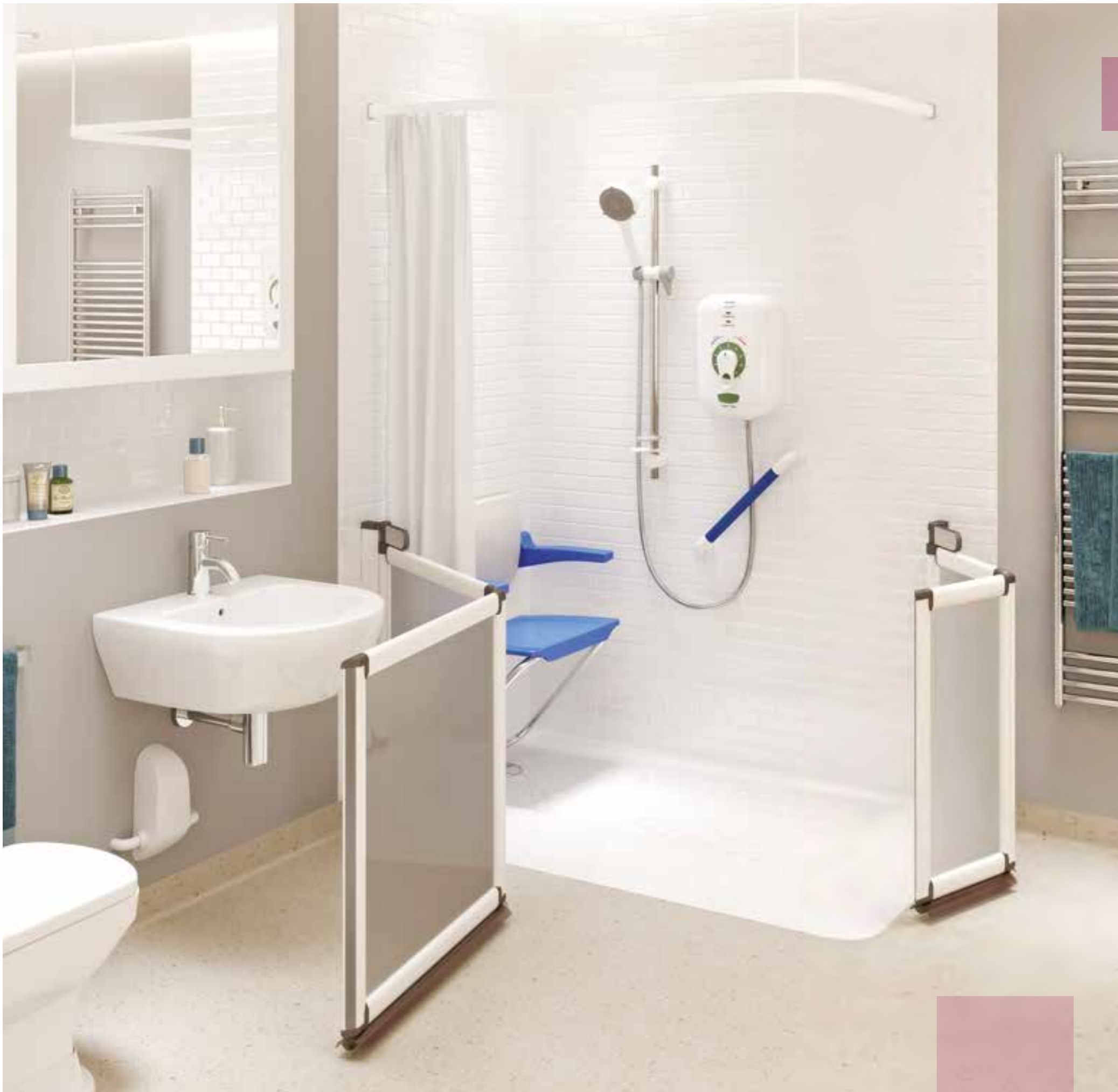

Enabling showering on an unbreachable floor

We offer two dedicated shower tray solutions for installing on unbreachable floors. Our Radiate and Mendip models are supplied with dedicated waste fittings within the height of the tray. Our Radiate range sits only 40mm in height and has been designed with integrated pumped drainage whereas our Mendip range is 100mm in height and features a gravity drain.

Both trays are supplied with our high performance tile upstand waterproofing membrane, providing a guaranteed seamless link between tray and tile.

All showertrays come complete with a high quality waste fitting.

Products featured include: Radiate 1300 x 700 pumped tray. Option H Bi-fold doors 1300mm x 700mm. L shape curtain rail (SRL-13090W). Slimfold Seat (SFS250WSB). Shower curtain (IC 2220). Whale SWP shower waste pump. 450mm Grab rail (IGF4/Blue). Triton Safeguard Plus Shower.

LIFETIME
GUARANTEE

For full details
see back cover

Radiate

Pumped solution for unbreachable floors

Radiate instantly solves the problem of fitting shower trays on unbreachable floors.

Classified to DIN 51097 Class 'B' on slip resistance*, setting a new level of care and design



Features a unique water channeling tread pattern

Acoustically tuned quiet waste

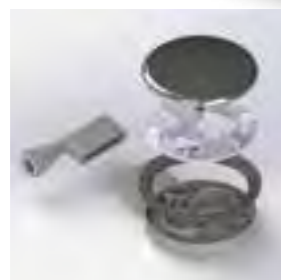

Pumped drainage supplied as standard

Matt, slip resistant finish*



LIFETIME GUARANTEE

For full details see back cover

- Ideal for high rise developments
- Designed to work with Whale SWP, Instant Match and Smoothflow waste pumps
- Available in 14 sizes including 2 bath replacement trays.
- Quick and easy to install
- We'd recommend fitting alongside our market leading folding/sliding half height shower doors and glass screens
- Reduced slip, matt finish and anti-shine surface for superior grip in wet and soapy conditions
- Tile upstand included. Guarantees a leak free seal to wall tiling
- Advanced ultra quiet drainage
- Easy to clean surface and gulley
- Designed specifically for pumped drainage
- Multiple waste outlet locations, within the height of the tray. Exit pipework from any side of the tray
- Ideally suited for use with electric showers

Access friendly

Only 40mm high and with compatible ramps available.

Low enough to offer easy access to those with limited mobility into the showering area.



* DIN 51097:1992 Determination of antislip properties; wet loaded barefoot areas; walking method; ramp test.

Radiate

Radiate delivers everything you're looking for to solve all the problems associated with unbreachable floors.

Radiate has been specifically designed for situations when gravity drainage is not possible. The pumped waste fitting, concealed perfectly within the underside of the tray, ensures that any water draining to the gully is quickly and efficiently fed to the waste pump, with a maximum flow rate of 11 litres per minute.

The tray features a unique water channelling tread pattern which has a reduced slip anti-shine surface. Classified to DIN 51097 Class 'B' on slip resistance*, Radiate sets a new level of care and design.

It is ideal for multi-storey developments and is compatible with pumped waste options including Impey and Whale SWP, Instant Match and Smoothflow pumps.

At 40mm high, and with optional ramps, it is low enough to offer easy access to those with limited mobility into the showering area.

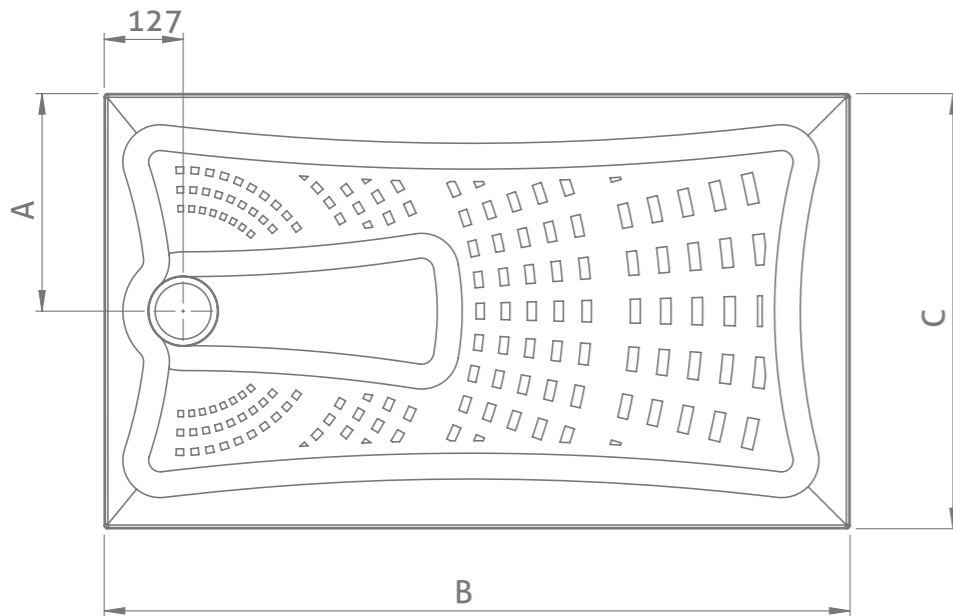

Radiate sizes and codes

Code	Size	Dimensions
NEW RDT9090/P	900 x 900	(A)450 / (B)900 / (C)900
RDT100100/P	1000 x 1000	(A)500 / (B)1000 / (C)1000
RDT12070/P	1200 x 700	(A)350 / (B)1200 / (C)700
NEW RDT12080/P	1200 x 800	(A)400 / (B)1200 / (C)800
NEW RDT12090/P	1200 x 900	(A)450 / (B)1200 / (C)900
RDT13070/P	1300 x 700	(A)350 / (B)1300 / (C)700
NEW RDT13080/P	1300 x 800	(A)400 / (B)1300 / (C)800
RDT14070/P	1400 x 700	(A)350 / (B)1400 / (C)700
NEW RDT14080/P	1400 x 800	(A)400 / (B)1400 / (C)800
NEW RDT14090/P	1400 x 900	(A)450 / (B)1400 / (C)900
RDT15070/P	1500 x 700	(A)350 / (B)1500 / (C)700
NEW RDT15080/P	1500 x 800	(A)400 / (B)1500 / (C)800
RDT17070/P	1700 x 700	(A)350 / (B)1700 / (C)700
RDT17080/P	1700 x 800	(A)400 / (B)1700 / (C)800

Ramp Kits

Code	Price
RDKIJ	£115.39
RDRCS	£42.09

Radiate is supplied with a pumped drain as standard.

Radiate - Bath Replacement



Radiate bath replacement trays have been designed so that they can be cut down to fit a wall to wall space where a bath was previously installed. A conventional multi purpose handsaw can be used to cut the shower tray.

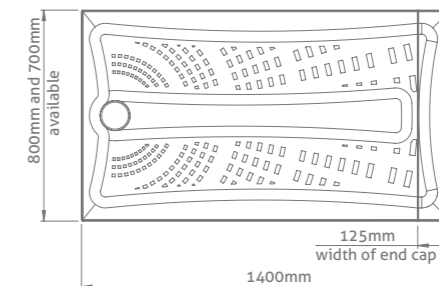
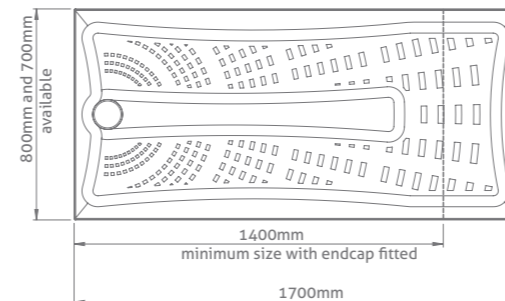

When measuring and cutting the tray please allow for the end cap. See illustration below.

The ideal solution for bath replacement

Tiling upstand

(Supplied with high performance tile upstand waterproofing membrane, providing a guaranteed seamless link between tray and tile)
Waterproof self adhesive tiling upstand (3.5m roll - 120mm wide) **Code: US12350**

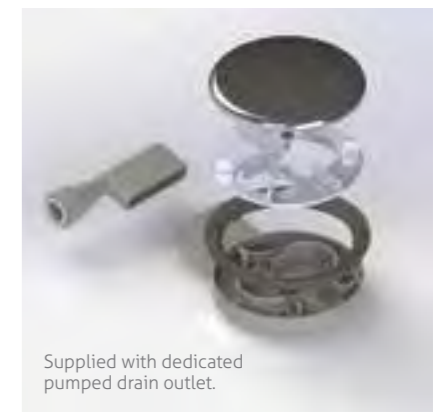

Supplied with dedicated pumped drain outlet.

Please visit www.impeyshowers.com to view our full range of product videos.

DIN 51097:1992 Determination of antislip properties; wet loaded barefoot areas; walking method; ramp test.

Mendip

Gravity solution for unbreachable floors

Supplied with a factory fitted waste trap with swivel outlet for drainage positioning. 50mm water seal compliant with building regulations.

Available in 7 sizes including a Bath Replacement Tray

Classified to DIN 51097 Class 'B' on slip resistance,* setting a new level of care and design

Fully self supporting so no need to bed down



Inspection cover



Tray depth of 100mm

100mm

Highly robust construction

Slip resistance classified to DIN 51097 Class 'A'



Cut to length version available with 2 end caps supplied



A 50mm half step or ramp are available to provide easier access

Mendip showertrays Flowrate 8-10 litres per minute depending on the size of Showertray

Showertray with above floor drainage

Designed for installations where the floor cannot be breached, as is often the case in situations such as multi storey apartments.

The waste fitting is housed beneath the tray, which is 100mm high. A 50mm half step or a sloping ramp are also available to provide easier access.

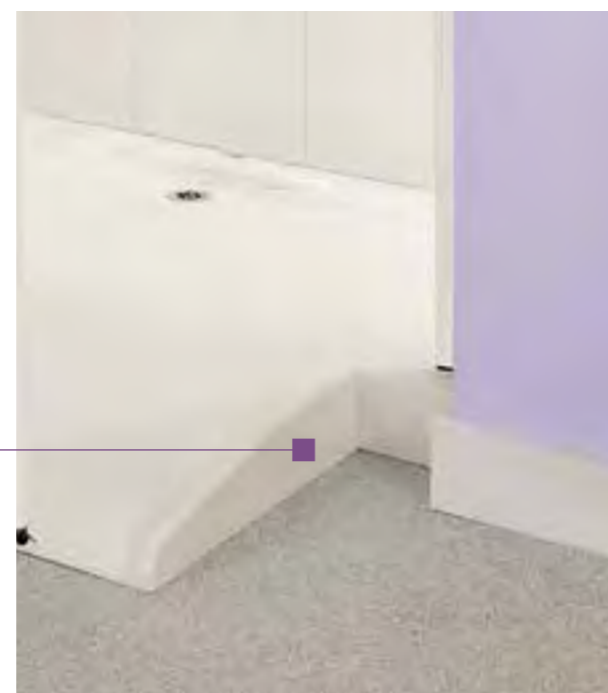

A 50mm half step or ramp are available to provide easier access

*Tray not included with ramp and half step

Access Ramp*

Size: 900 x 400mm
Code: MEN/R01



50mm Half Step*

Size: 720 x 300mm
Code: MEN/P01



Available in a range of sizes:

900 x 900mm	Code: MEN501/C
1000 x 1000mm	Code: MEN601/C
1250 x 710mm	Code: MEN101/C
1250 x 830mm	Code: MEN201/C
1500 x 710mm	Code: MEN301/C
1500 x 830mm	Code: MEN401/C
1850 x 710mm	Code: MEN701/C



Size: 900 x 900mm
Code: MEN501/C



Size: 1000 x 1000mm
Code: MEN601/C



Size: 1250 x 710mm
Code: MEN101/C



Size: 1250 x 830mm
Code: MEN201/C



Size: 1500 x 710mm
Code: MEN301/C



Size: 1500 x 830mm
Code: MEN401/C



Size: 1850 x 710mm
Code: MEN701/C (cut to length version with two end caps supplied - trim with saw)

All Mendip trays come supplied with Tiling up stand and Waste



Tiling upstand

(Supplied with high performance tile upstand waterproofing membrane, providing a guaranteed seamless link between tray and tile)

Waterproof self adhesive tiling upstand (3.5m roll - 120mm wide)
Code: US12350



All Mendip trays include a factory fitted waste trap
The compact above ground gully has a swivel outlet for drainage positioning. It has a 40mm outlet and a 50mm water seal. Designed to be used with single feed instantaneous electric showers and medium flow mixer valves.

Low level showertrays

From as low as 24mm

We offer a wide range of shower trays to suit all types of applications. Our low level shower trays are built to accommodate both gravity and pumped drainage whilst also providing easy access with compatible ramps.

Products featured include: Slimfold Shower Seat Sky Blue (SFS250WSB). Slimline Showertray 1200 x 750 (SL3512075). Maxi-Grip Plus Grab Rail (bespoke option). Redring Selectronic Plus Shower. Elevate Folding Doors (Option H).



Mantis showertray

New for 2016

Only 24mm high, lowest tray on the market

Slip resistant surface - tested and qualified in accordance with DIN 51097 Class 'B'



Tiling upstand

(Supplied with high performance tile upstand waterproofing membrane, providing a guaranteed seamless link between tray and tile)

Waterproof self adhesive tiling upstand (3.5m roll - 120mm wide)

Code: US12350

- Step in height of only 24mm
- 12 Sizes in total including 2 bath replacement trays
- End center drain position
- Flow rate: 11 l/min
- Ideally suited for use with electric showers
- 90mm waste & Tile upstand supplied (other waste choices are available)
- Unhanded tray
- Easy clean surface
- Versatile installation - can be recessed into the floor to provide 100% level access



At just 24mm in height, the Mantis showertray delivers a significant advancement in low level showering specification. Tested in accordance with the same DIN 51097 Class 'B' high slip safety rating as Radiate.

24mm low level access tray



Satin, slip resistant* finish - DIN 51097 Class 'B'

LIFETIME GUARANTEE
For full details see back cover

*DIN 51097:1992 Determination of antislip properties; wet loaded barefoot areas; walking method; ramp test.

Mantis

The Mantis Shower tray is the industry's first ultra slim shower tray and lowest available on the market at only 24mm in height

Developed after direct consultation with Occupational Therapists and Contractors, Mantis offers the perfect solution in situations when a floor former cannot be installed. Mantis can be installed above or below ground to suit specific locations, has a flow rate of 11 litres per minute and is supplied with a tile upstand and compatible gravity drainage.

Similar to Radiate, Mantis has been designed with an easy to clean, slip resistant satin tread pattern that qualifies to DIN 51097 Class 'B' on slip resistance. This provides an increased grip for users in wet, soapy conditions compared to more traditional shower trays. Mantis is available in 7 sizes including 2 bath replacement sizes which can also be cut down to a minimum length of 1400mm with supplied end caps to ensure a perfect fit. Bedding down of the tray is recommended.

The ultra slim height of only 24mm allows for direct use with a wheelchair.

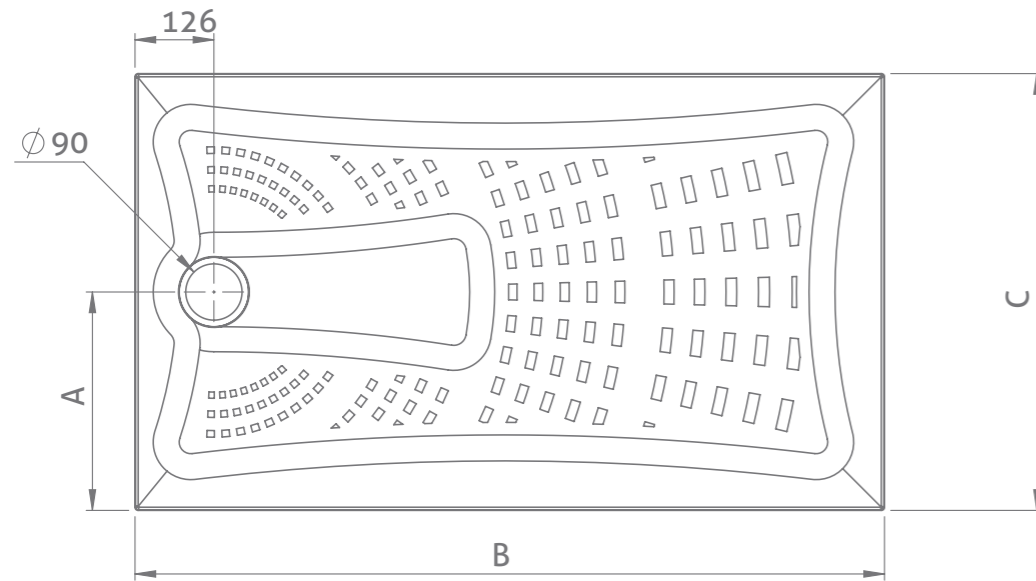

Mantis sizes and codes

Code	Size	Dimensions
NEW MTS9090	900 x 900	(A)449 / (B)900 / (C)900
MTS100100	1000 x 1000	(A)499 / (B)1000 / (C)1000
MTS12070	1200 x 700	(A)349 / (B)1200 / (C)700
NEW MTS12080	1200 x 800	(A)399 / (B)1200 / (C)800
MTS13070	1300 x 700	(A)349 / (B)1300 / (C)700
NEW MTS13080	1300 x 800	(A)399 / (B)1300 / (C)800
MTS14070	1400 x 700	(A)349 / (B)1400 / (C)700
NEW MTS14080	1400 x 800	(A)399 / (B)1400 / (C)800
MTS15070	1500 x 700	(A)349 / (B)1500 / (C)700
NEW MTS15080	1500 x 800	(A)399 / (B)1500 / (C)800
MTS17070	1700 x 700	(A)349 / (B)1700 / (C)700
MTS17080	1700 x 800	(A)399 / (B)1700 / (C)800

Mantis is supplied with horizontal outlet drain as standard.

Mantis - Bath Replacement



Mantis bath replacement trays have been designed so that they can be cut down to fit a wall to wall space where a bath was previously installed. A conventional multi purpose handsaw can be used to cut the shower tray.

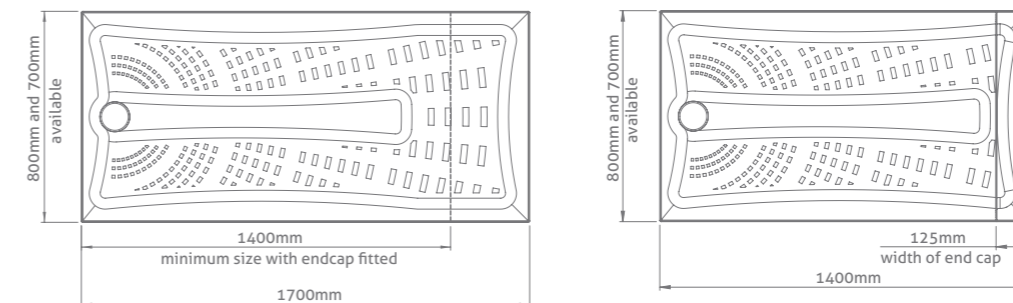

When measuring and cutting the tray please allow for the the end cap
See illustration below.

All Mantis trays come supplied with Tiling up stand and Waste

Tiling upstand

(Supplied with high performance tile upstand waterproofing membrane, providing a guaranteed seamless link between tray and tile)
Waterproof self adhesive tiling upstand (3.5m roll - 120mm wide) Code: US12350



All supplied with 90mm trap.
Code: IMOR/H
Alternatives available see page 81

Slimline showertray

Our most versatile high performance showertray

Classified to DIN 51097 Class 'A' on slip resistance*

Offset waste to assist in avoiding underfloor obstructions

Slip resistant tread pattern

Low level installation only 35mm high to provide easy access

35mm



Ramps available to allow wheelchair access

LIFETIME GUARANTEE

For full details see back cover

The 35mm high Slimline showertray incorporates an ergonomic slip resistant design with industry leading flow rates of up to 38 litres per minute.

They can also be recessed into the floor or fitted with a ramp around the entire perimeter for easier access.

Strong GRP construction safely supports up to 250kg (40 stone)

Supplied with 90mm IMOR/H drain as standard



Tiling upstand

(Supplied with high performance tile upstand waterproofing membrane, providing a guaranteed seamless link between tray and tile)

Waterproof self adhesive tiling upstand (3.5m roll - 120mm wide)
Code: US12350

- Other drainage options such as Pumped and slimline available
- Service ducting available to conceal pipework making installation easier as there is no need to chase out the walls or floors
- Compatible with all Impey shower doors and glass panels
- Available in 9 sizes
- Cut to length version available with 2 end caps supplied
- Maximum flow rate of up to 38 litres per minute
- Versatile installation - can be recessed into the floor to provide 100% level access
- Easy clean surface
- 35mm high
- Non-handed design

*DIN 51097:1992 Determination of antislip properties; wet loaded barefoot areas; walking method; ramp test.

Slimline showertrays

Flowrate up to 37 litres per minute depending on the size of Showertray

This modern, stylish slimline tray from Impey offers a low-level installation at only 35mm high.

They can also be recessed into the floor or fitted with a ramp around the entire perimeter for easier access. Robust GRP construction will support up to 250kg (40 stone). Service ducting to conceal pipe work is available, which makes installation easier by removing the need to chase out the floor or walls.

LIFETIME GUARANTEE

For full details see back cover

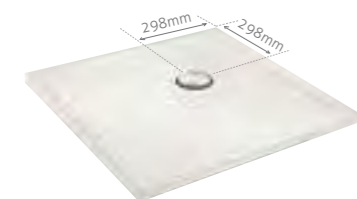

Size: 800 x 800mm
Code: SL358080

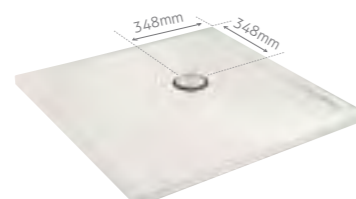

Size: 900 x 900mm
Code: SL359090

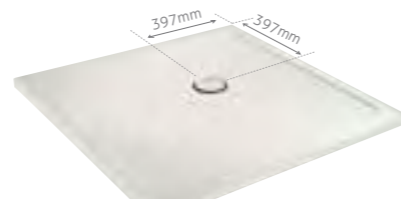

Size: 1000 x 1000mm
Code: SL35100100

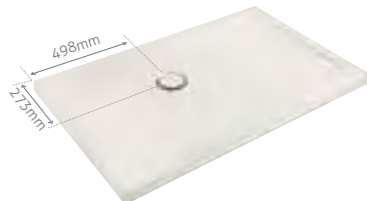

Size: 1200 x 750mm
Code: SL3512075

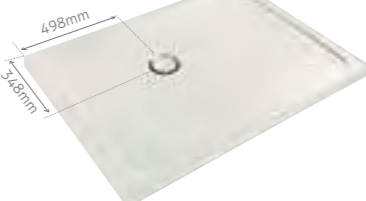

Size: 1200 x 900mm
Code: SL3512090

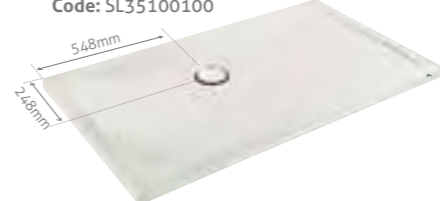

Size: 1300 x 700mm
Code: SL3513070

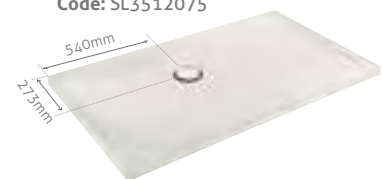

Size: 1300 x 750mm
Code: SL3513075

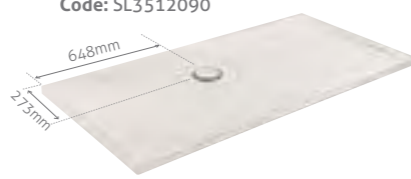

Size: 1500 x 750mm
Code: SL3515075

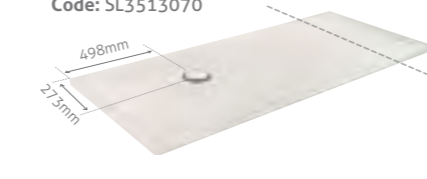

Size: 1700 x 750mm
Code: SL3517075/CWEC
(Can be cut to length. End cap supplied)

Service Ducting and Ramp Kit

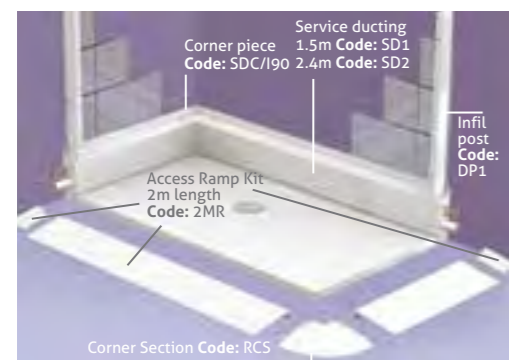

Versatile installation

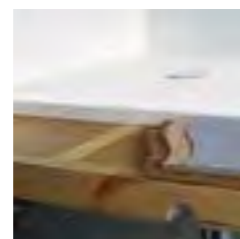

Can be recessed into floor for level access

Tiling upstand

(supplied with each tray)
Waterproof self adhesive tiling upstand (3.5m roll - 120mm wide)
Code: US12350



All supplied with 90mm trap.
Code: IMOR/H
Alternatives available see page 73

Bath replacement showertrays

Flowrate up to 36 litres per minute depending on the size of Showertray

These have been specially designed to cover all the sizes required to replace a bath, whilst still offering a low-level installation at only 35mm high.

They can also be recessed into the floor. Robust GRP construction will support up to 250kg (40 stone).

LIFETIME GUARANTEE

For full details see back cover

Classified to DIN 51097 Class 'B' on slip resistance, setting a new level of care and design

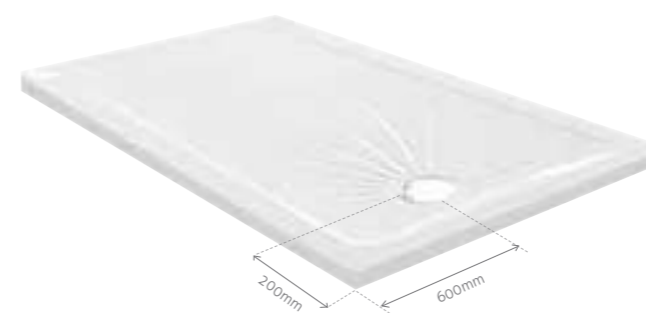

Size: 1200 x 900mm
Code: BRT129M

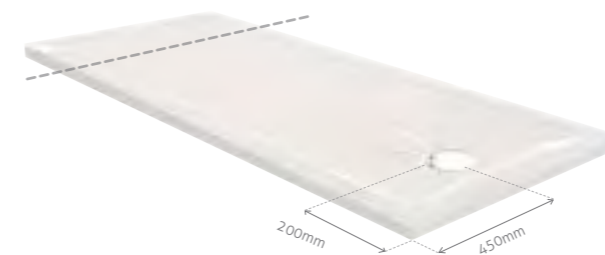

Size: 1700 x 750mm
Code: BRT1775M
(Can be cut to length. End cap supplied separately)
Code (End cap): BRTM/EC75

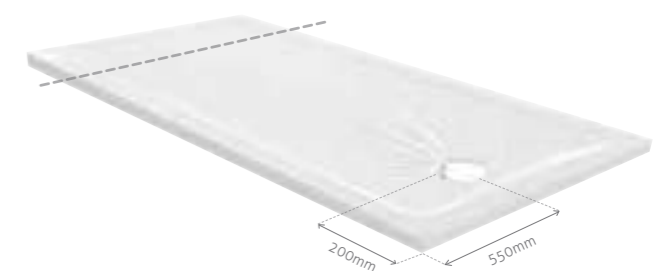

Size: 1700 x 850mm
Code: BRT1785M
(Can be cut to length. End cap supplied separately)
Code (End cap): BRTM/EC85

Tiling upstand

(Supplied with high performance tile upstand waterproofing membrane, providing a guaranteed seamless link between tray and tile)
Waterproof self adhesive tiling upstand (3.5m roll - 120mm wide)

Code: US12350



All supplied with 90mm trap.
Code: IMOR/H
Alternatives available see page 81

Features a new matt, slip resistant surface

NEW Half Height Shower Doors

Outstanding half height
shower door solutions
for every care sector
installation

Impey shower doors - the best in the industry.

They set the industry benchmark since 1990 and now they're an even smarter choice to specify.

Designed, developed and manufactured by Impey in the UK, the new ranges provide outstanding innovative features for both user and carer and those in the care sector - from Occupational Therapists specifying for private and sheltered homes to Technical Officers looking for quality and affordability when pricing for care homes and new builds.

There is no better half height shower door.

Impey provide everything you need for a high quality wetroom installation

Solutions to suit every healthcare installation, improving the lives of thousands of people every year

Special and bespoke sizes available in both ranges

Unbeatable customer service offering order processing and technical support plus installation training



NEW Elevate

Sliding & folding shower doors

Designed for the Care Sector

Easier fitting, easier opening and easier cleaning.

Re-designed for all:

Arthritis sufferers - Operating the doors requires minimal grip

Visually impaired - Contrasting colour schemes provide optimum visibility

Carers and users - Smooth, quick and easy to open mechanisms

Infection control - Unique market leading wipe clean surface layer with no dirt traps

Safer to use - Folding door hinges are fully enclosed, eliminating any risk of finger trapping

Shatterproof - PETG panel construction for guaranteed safety

Dementia sufferers - Non reflective panels provide cognitive calm



Designed and manufactured to the highest standards for safety and durability



LIFETIME GUARANTEE

CE tested to BS EN 14428

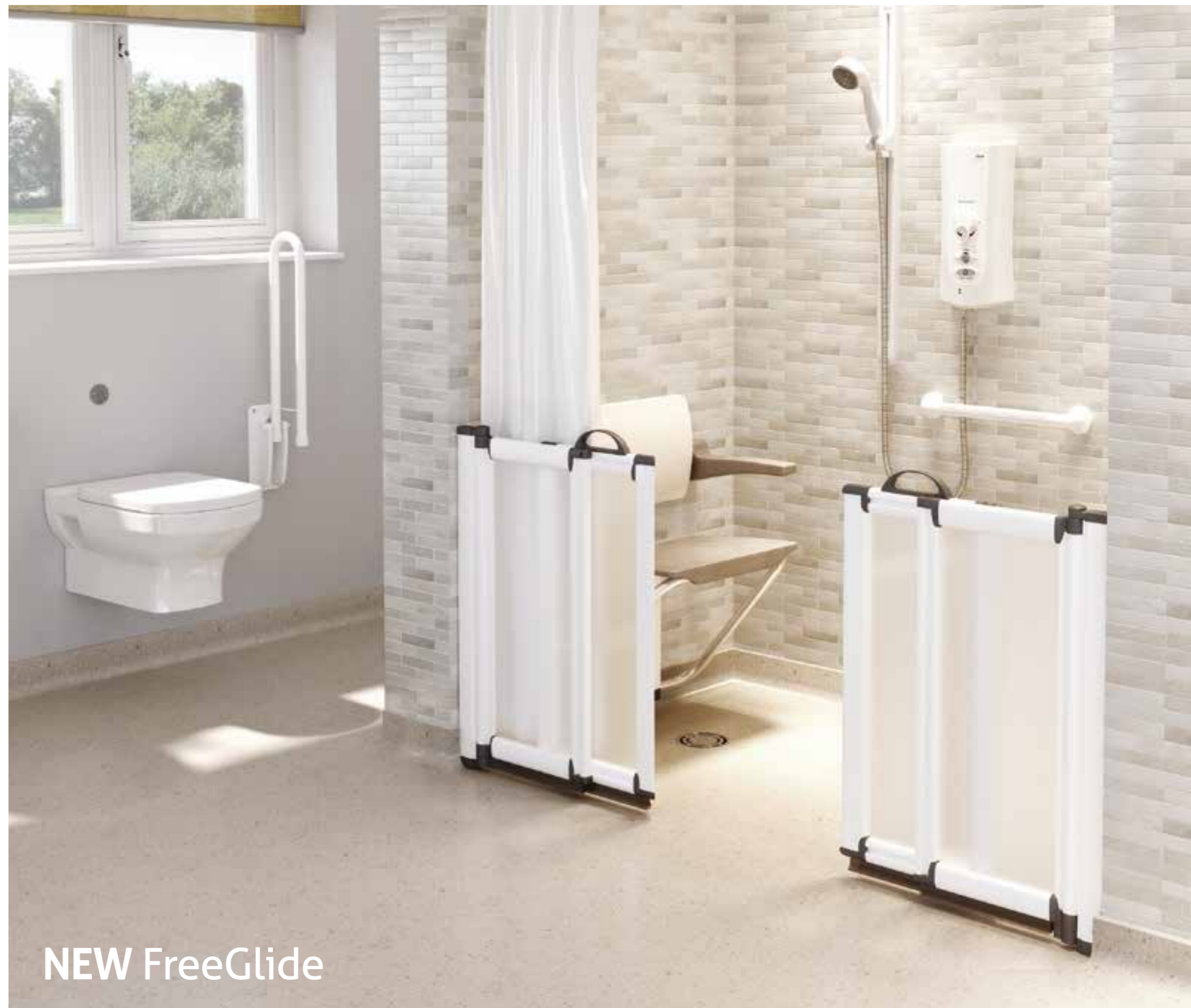

NEW FreeGlide

Elevate

Raising the standards for folding and Sliding doors

Bi-Fold or Sliding versions available

User Benefits

- **Intuitive & Easy to Use**
Elevate door lift solution
- **Easy to Grasp Handle**
For users with limited grip & mobility by simply placing your hand through and lifting
- **Colour Contrasting Design**
To assist users who are partially sighted
- **Double Contact Floor Seals**
To minimise water leaks
- **Easy Clean Design**
To minimise areas where dirt can build up with concealed moving parts and screwheads and clean wipe down surfaces
- **SMART Safety Features**
Enclosed hinges eliminate dirt and finger traps



Elevate EasyLift

Simply rotate the paddle 90° to lift the doors clear of the floor

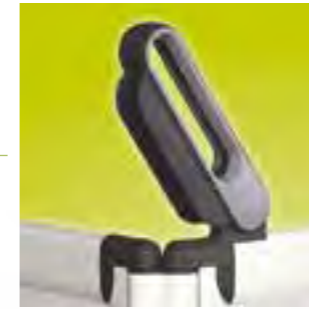

Elevate Latch Handle

No grip required for users with limited strength & mobility by simply placing your hand through and lifting



■ Anti-Glare Safety Glass

Considered anti-glare surfaces for users with dementia

■ PETG Safety Panels

Shatterproof panels as standard

Internal Glazing Seals

Eliminate dirt traps and provides a stay clean longer finish



Enclosed Hinges

To eliminate dirt and finger traps

Installer Benefits

- Ready to install out of the box
- Pre-drilled fixings holes
- Next day delivery
- All fixings provided
- Door height setting tool supplied as standard
- Pre-assembled handles
- Pre-cut coving profiles for shower trays, tiled and vinyl floors
- Slotted compensator for easier installation with 25mm adjustment
- Fully detailed installation instructions provided
- Average install time of 20 minutes

Specifier Benefits

- Available in wide range of options and sizes
- Easy to replace seal and serviceable parts
- Designed and built by Impey the industry leaders
- Lifetime guarantee
- Special and bespoke sizes available to order
- Unbeatable customer service and technical support
- Next day delivery

LIFETIME
GUARANTEE

Elevate Bi-Fold shower door shown

FreeGlide

Assured quality and advanced design features from the Industry's leading brand

Bi-Fold or Sliding versions available

User Benefits

- **EASY On The Eye**
Considered anti-glare surfaces for users with dementia
- **EASY Clean Design**
Thoughtful design to minimise areas where dirt can build up with concealed moving parts and screwheads and clean wipe down surfaces
- **SMART Safety Features**
Enclosed hinges eliminate dirt and finger traps



EASY Action
Easy to use FreeGlide rising hinge

EASY Clean
Unique sliding door unclip pivot mechanism, no tools required

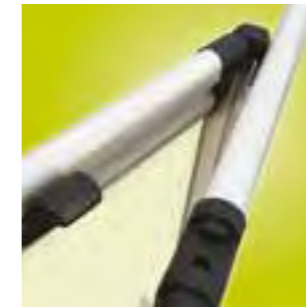

EASY Grip
No grip required for users with limited strength & mobility by simply placing your hand through and sliding

■ Shatterproof PETG panels as standard



Double Contact Floor Seals
To minimise water leaks

Installer Benefits

- Next day delivery
- All fixings provided
- 25mm adjustment in the wall channels
- Door height setting tool supplied
- Slotted compensator for easier installation
- Average install time of 20 minutes
- Fully detailed installation instructions provided
- Easy Fitting - Floor to rail pole, using Tiger fix to anchor at the base - no through the floor or tray drilling required
- Pre-drilled fittings

Specifier Benefits

- Easy to replace seals & serviceable parts
- Designed to suit most applications
- Unbeatable customer service and technical support
- Special and bespoke options available
- Next day delivery
- Lifetime guarantee
- Available in wide range of options and sizes

FreeGlide sliding door shown

LIFETIME
GUARANTEE

Curtain Rails

Description

3 types of rails are available; U shaped, Corner rails and straight rails in many standard sizes. Bespoke sizes can be made to order.

All the rails are white and made from powder coated aluminium and come complete with fixings which includes, all brackets, screws, rawl plugs, ceiling support rods and shower curtain hooks and gliders

Product codes & sizes

Curved Rails

SRL-9090W	CURVED RAIL 900 x 900 + FIXING KIT WHITE
SRL-120120W	CURVED RAIL 1200 x 1200 + FIXING KIT WHITE
SRL-13090W	CURVED RAIL 1300 x 900 + FIXING KIT WHITE
SRL-15090W	CURVED RAIL 1500 x 900 + FIXING KIT WHITE
SRL-150120W	CURVED RAIL 1500 x 1200 + FIXING KIT WHITE
SRL-18090W	CURVED RAIL 1800 x 900 + FIXING KIT WHITE

Straight Rails

SRS-130W	STRAIGHT SHOWER RAIL 1.3M + FIXING KIT WHITE
SRS-200W	STRAIGHT SHOWER RAIL 2M + FIXING KIT WHITE
SRS-250W	STRAIGHT SHOWER RAIL 2.5M + FIXING KIT WHITE

U Rails

SRU-100100W	U RAIL 1000 x 1000 + FIXING KIT WHITE (W)892mm x (D)940mm
SRU-120120W	U RAIL 1200 x 1200 + FIXING KIT WHITE (W)1092mm x (D)1140mm
SRU-13080W	U RAIL 1300 x 800 + FIXING KIT WHITE (W)1192mm x (D)740mm
SRU-14090W	U RAIL 1400 x 900 + FIXING KIT WHITE (W)1292mm x (D)840mm
SRU-150120W	U RAIL 1500 x 1200 + FITTING KIT WHITE (W)1392mm x (D)1140mm

Curved rail support rod

The 1.2M trimable curtain support rod is for installations with high ceilings

SR-CRSW	CURVED RAIL SUPPORT ROD 1.2 m + FIXING KIT WHITE
---------	--

Spare Hooks and Gliders

Spare Curtain rail hooks and gliders for curtain attachment

SR-HGK	SPARE HOOKS & GLIDERS
--------	-----------------------

Shower Curtains

- White only 100% Polyester
- CIBA Antibacterial & Fungal Protection
- Easy care fabric, specially produced for the bathroom
- Machine Washable
- Weighted hem to ensure good contact with tray or wet floor
- Range of sizes to suit all showering options

Code	Width x Drop
IC1212	W1200 x D1200mm
IC180125	W1800 x D1250mm
IC1818	W1800 x D1800mm
IC1820	W1800 x D2000mm
IC1824	W1800 x D2400mm
IC2018	W2000 x D1800mm
IC2020	W2000 x D2000mm
IC2218	W2200 x D1800mm
IC2220	W2200 x D2000mm
IC2222	W2200 x D2200mm
IC2418	W2400 x D1800mm
IC2420	W2400 x D2000mm

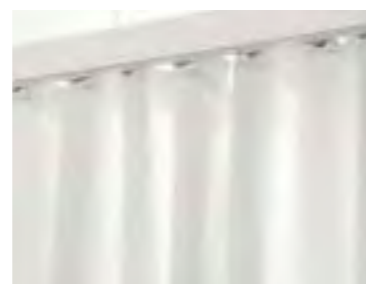
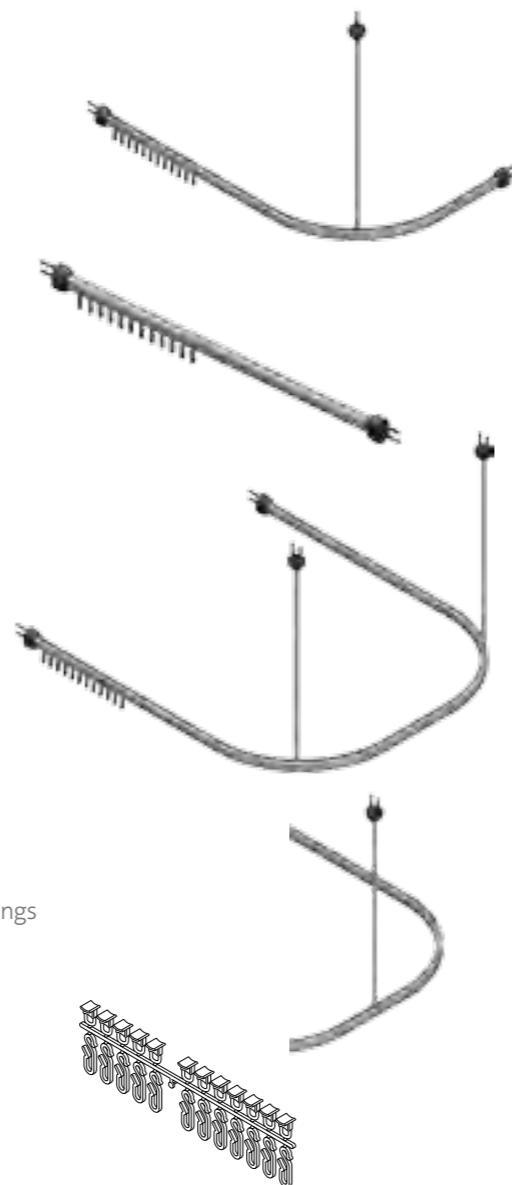

Window Bridging Kit

Description

The window bridging kit provides a simple solution in situations where a window causes an obstruction during curtain rail installations.

This kit can be used inside the window opening, outside the window opening and dog leg around the window opening.

Pack contains: 1.3M Rail, 1.2M Curtain, 2 corner brackets, pack of hooks and gliders and 2 wall brackets and fittings.

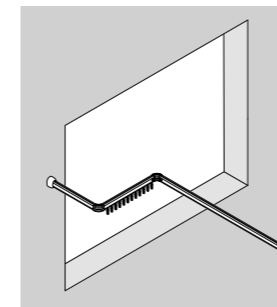

Dog Leg Installation Window Bridging Kit

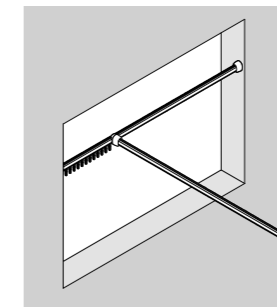

Alcove Window Bridging Kit

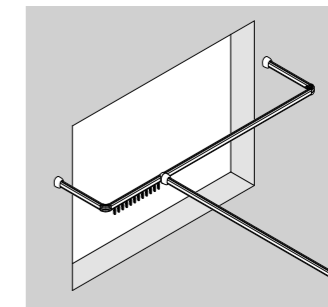

Outer Window Bridging Kit

Product codes & sizes

SR-WBKW	WINDOW BRIDGING KIT C/W 1.2 DROP CURTAIN WHITE
---------	--

Extension Channel Pack

Description

The extension channel pack is used when you need to increase the width of a door or fixed panel from the wall. Each extension kit will increase the width by 20mm.

In a corner installation 2 packs will be necessary and 2 channels can be combined to increase by 40mm

Pack contains: 1 wall channel, end cap & fittings

Product codes & sizes

FG-ECP	EXTENSION CHANNEL PACK
--------	------------------------

Freestanding Carer Screens

Description

Lightweight portable freestanding shower screens offer an instant solution for shower areas that do not require a permanent fixture. 750mm High and made from white powder coated aluminium with grey handles and flexible floor seals.

Semi-transparent, anti-shatter PETG panels

Product codes & sizes

FG-IPS1W	FREESTANDING SCREEN 2 PANEL 650MM
FG-IPS2W	FREESTANDING SCREEN 2 PANEL 750MM
FG-IPS3W	FREESTANDING SCREEN 2 PANEL 1000MM
FG-IPS4W	FREESTANDING SCREEN 4 PANEL 2 x 400MM wide + 2 x 225MM wide



Wetroom floor door options for corners

All corner options can be supplied with L-shaped curtain rail and curtain. All door configurations are available left or right handed (left hand illustrated).



Option C

Fixed 750mm wide half height fixed panel, floor to ceiling pole

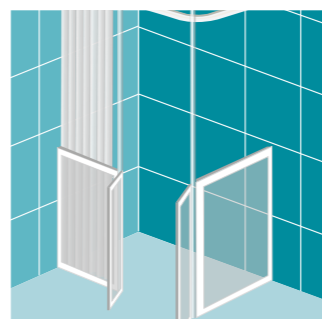

Option D

Two fixed half height panels, one 400mm on front, with floor to ceiling poles with one door hung from each panel

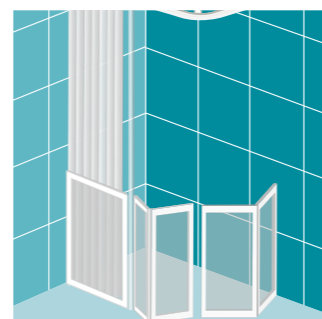

Option E

400mm fixed half height panel with floor to ceiling pole and a pair of bi-fold doors meeting on corner

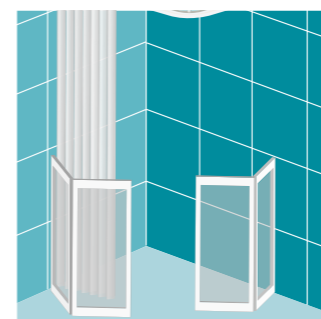

Option H

Two half height bi-fold doors meeting on the corner



Option J

One bi-fold and single door meeting on the corner



Option 1

Pair of sliding doors meeting on the corner



Option 6

Fixed 400mm half height panel, floor to ceiling pole with pair of sliders meeting a return pair of sliders on the corner

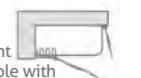

Floor Former	SIZE	Option C	Option D	Option E	Option H	Option J	Option 1	Option 6
Level-Dec EasyFit	800 x 800	•			•	•	•	
	900 x 900	•			•	•	•	
	1000 x 1000	•			•	•	•	
	1200 x 750	•			•	•	•	
	1200 x 900	•	•		•	•	•	•
	1200 x 1200	•	•	•	•	•	•	•
	1300 x 800	•	•	•	•	•	•	•
	1400 x 900	•	•	•	•	•	•	•
	1500 x 800	•	•	•	•	•	•	•
	1500 x 1200	•	•	•	•	•	•	•
	1700 x 750	•	•	•	•	•	•	•
	1850 x 900	•	•	•	•	•	•	•

• For door options with Level-Grade please call our Technical Team on 01460 258682

Wetroom floor door options for alcoves

All alcove options can be supplied with straight curtain rail and curtain. All door configurations are available left or right handed (left hand illustrated).

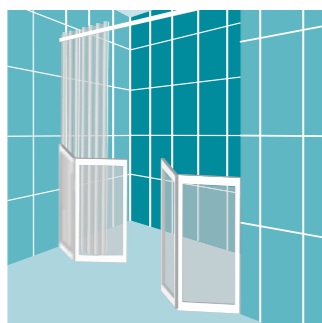

Option G

Two half bi-fold doors meeting in the middle

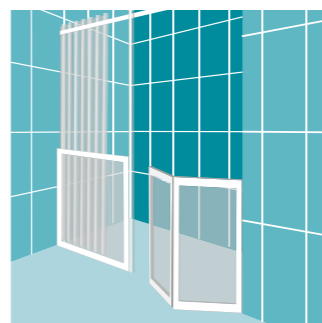

Option M

One bi-fold door meeting fixed 400mm panel with floor to ceiling pole

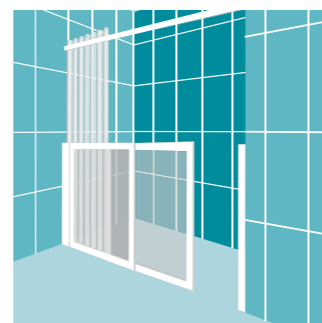
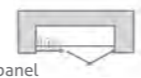

Option 2

One set of sliding doors hung off one side latching on opposite wall

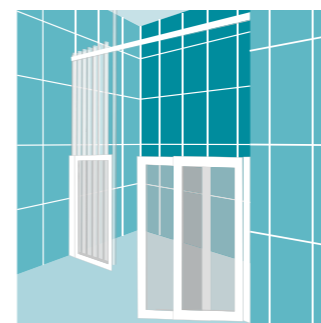

Option 3

One fixed half height 400mm panel with floor to ceiling pole and one sliding door hung from opposite wall

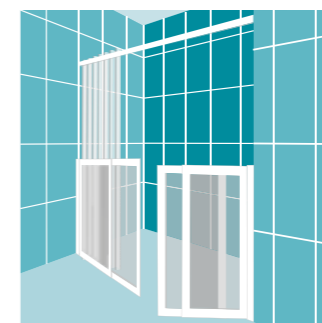

Option 4

Pair of sliding doors hung between walls meeting in middle

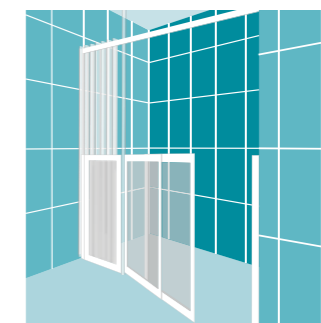

Option 5

One 400mm fixed half height panel with floor to ceiling pole, one sliding door hung off pole and latching on opposite wall

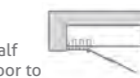

Floor Former	SIZE	Option G	Option M	Option 2	Option 3	Option 4	Option 5
Level-Dec EasyFit	800 x 800			•			
	900 x 900			•			
	1000 x 1000			•			
	1200 x 750	•	•	•	•	•	•
	1200 x 900	•	•	•	•	•	•
	1200 x 1200	•	•	•	•	•	•
	1300 x 800	•	•	•	•	•	•
	1400 x 900	•	•	•	•	•	•
	1500 x 800	•	•	•	•	•	•
	1500 x 1200	•	•	•	•	•	•
	1700 x 750**	•	•	•	•	•	•
	1850 x 900**	•	•	•	•	•	•

Special and bespoke sizes available in both ranges

For a comprehensive list of all tray and dec sizes visit: impeyshowers.com or call our technical helpline: 01460 258 682

Showertray door options for corners

All corner options can be supplied with L-shaped curtain rail and curtain. All door configurations are available left or right handed (left hand illustrated).

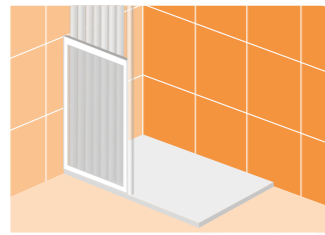

Option C
Fixed 750mm wide half height fixed panel, floor to ceiling pole

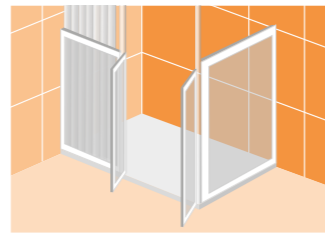

Option D
Two fixed half height panels, one 400mm on front, with floor to ceiling poles with one door hung from each panel

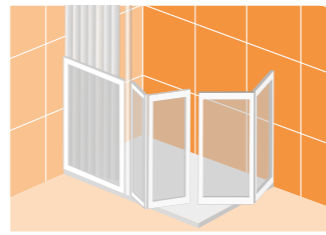

Option E
400mm fixed half height panel with floor to ceiling pole and a pair of bi-fold door meeting on corner

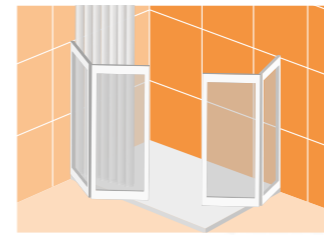

Option H
Two half height bi-fold doors meeting on the corner

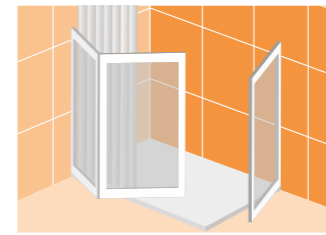

Option J
One bi-fold and single door meeting on the corner

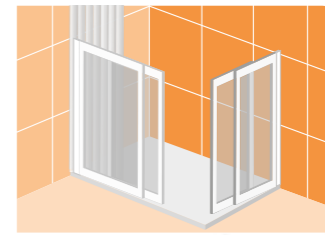

Option 1
Pair of sliding doors meeting on the corner

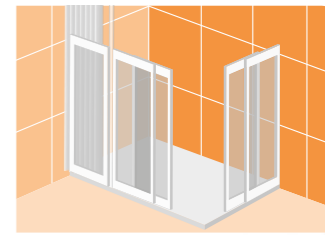

Option 6
Fixed 400mm half height panel, floor to ceiling pole with pair of sliders meeting a return pair of sliders on the corner

Showertray	CODE	SIZE						
Slimline 35	SL358080	800 x 800	●				●	
	SL359090	900 x 900	●				●	
	SL35100100	1000 x 1000	●				●	
	SL3512075	1200 x 750	●	●	●		●	●
	SL3512090	1200 x 900	●	●	●		●	●
	SL3513070	1300 x 700	●	●	●		●	●
	SL3513075	1300 x 750	●	●	●		●	●
	SL3515075**	1500 x 750	●	●	●		●	●
	SL3517075**	1700 x 750	●	●	●		●	●
Bath Replacement	BRT129M	1200 x 900	●	●	●		●	●
	BRT1775M	1700 x 750	●	●	●		●	●
	BRT1785M	1700 x 850	●	●	●		●	●
Mendip	MEN501	900 x 900	●				●	
	MEN601	1000 x 1000	●				●	
	MEN101	1250 x 710	●	●	●		●	●
	MEN201	1250 x 830	●	●	●		●	●
	MEN301	1500 x 710	●	●	●		●	●
	MEN401	1500 x 830	●	●	●		●	●
	MEN701**	1850 x 710	●	●	●		●	●
Radiate	RDT9090/P	900 x 900	●				●	
	RDT100100/P	1000 x 1000	●				●	
	RDT12070/P	1200 x 700	●	●	●		●	●
	RDT12080/P	1200 x 800	●	●	●		●	●
	RDT12090/P	1200 x 900	●	●	●		●	●
	RDT13070/P	1300 x 700	●	●	●		●	●
	RDT13080/P	1300 x 800	●	●	●		●	●
	RDT14070/P	1400 x 700	●	●	●		●	●
	RDT14080/P	1400 x 800	●	●	●		●	●
	RDT14090/P	1400 x 900	●	●	●		●	●
	RDT15070/P	1500 x 700	●	●	●		●	●
	RDT15080/P	1500 x 800	●	●	●		●	●
	RDT17070/P	1700 x 700	●	●	●		●	●
RDT17080/P	1700 x 800	●	●	●		●	●	
Mantis	MTS9090	900 x 900	●				●	
	MTS100100	1000 x 1000	●				●	
	MTS12070	1200 x 700	●	●	●		●	●
	MTS12080	1200 x 800	●	●	●		●	●
	MTS13070	1300 x 700	●	●	●		●	●
	MTS13080	1300 x 800	●	●	●		●	●
	MTS14070	1400 x 700	●	●	●		●	●
	MTS14080	1400 x 800	●	●	●		●	●
	MTS15070	1500 x 700	●	●	●		●	●
	MTS15080	1500 x 800	●	●	●		●	●
	MTS17070	1700 x 700	●	●	●		●	●
	MTS17080	1700 x 800	●	●	●		●	●

Special and bespoke sizes available in both ranges

For a comprehensive list of all tray and dec sizes visit www.impeyshowers.com or call our technical helpline: 01460 258 682

Showertray door options for alcoves

All alcove options can be supplied with straight curtain rail and curtain. All door configurations are available left or right handed (left hand illustrated).

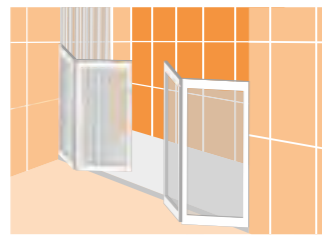

Option G
Two half bi-fold doors meeting in the middle

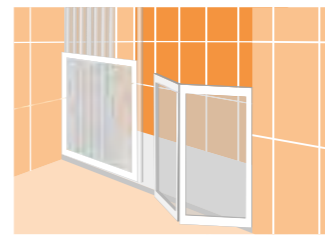

Option M
One bi-fold meeting fixed 400mm panel with floor to ceiling pole

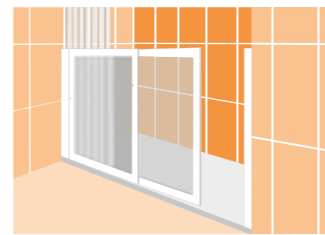

Option 2
One set of sliding doors hung off one side latching on opposite wall

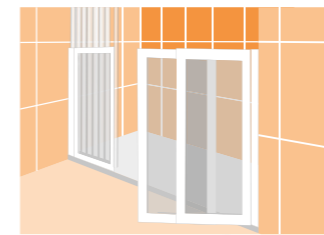

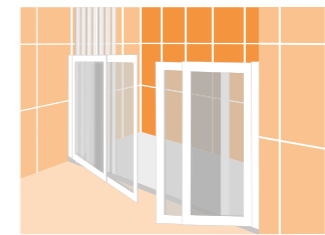

Option 3
One fixed half height 400mm panel with floor to ceiling pole and one sliding door hung from opposite wall

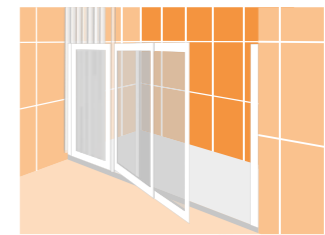

Option 4
Pair of sliding doors hung between walls meeting in middle

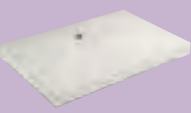
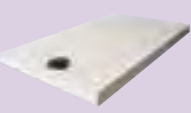

Option 5
One 400mm fixed half height panel with floor to ceiling pole, one sliding door hung off pole and latching on opposite wall

Showertray	CODE	SIZE						
Slimline 35 	SL358080	800 x 800						
	SL359090	900 x 900						
	SL35100100	1000 x 1000						
	SL3512075	1200 x 750	•	•	•	•	•	•
	SL3512090	1200 x 900	•	•	•	•	•	•
	SL3513070	1300 x 700	•	•	•	•	•	•
	SL3513075	1300 x 750	•	•	•	•	•	•
	SL3515075**	1500 x 750	•	•	•	•	•	•
	SL3517075**	1700 x 750	•	•	•	•	•	•
Bath Replacement	BRTM	1200 x 900	•	•	•	•	•	•
	BRT1775M	1700 x 750	•	•	•	•	•	•
	BRT1785M	1700 x 850	•	•	•	•	•	•
Mendip 	MEN501	900 x 900						
	MEN601	1000 x 1000						
	MEN101	1250 x 710	•	•	•	•	•	•
	MEN201	1250 x 830	•	•	•	•	•	•
	MEN301	1500 x 710	•	•	•	•	•	•
	MEN401	1500 x 830	•	•	•	•	•	•
	MEN701**	1850 x 710	•	•	•	•	•	•
Radiate 	RDT9090/P	900 x 900						
	RDT100100/P	1000 x 1000						
	RDT12070/P	1200 x 700	•	•	•	•	•	•
	RDT12080/P	1200 x 800	•	•	•	•	•	•
	RDT12090/P	1200 x 900	•	•	•	•	•	•
	RDT13070/P	1300 x 700	•	•	•	•	•	•
	RDT13080/P	1300 x 800	•	•	•	•	•	•
	RDT14070/P	1400 x 700	•	•	•	•	•	•
	RDT14080/P	1400 x 800	•	•	•	•	•	•
	RDT14090/P	1400 x 900	•	•	•	•	•	•
	RDT15070/P	1500 x 700	•	•	•	•	•	•
	RDT15080/P	1500 x 800	•	•	•	•	•	•
	RDT17070/P	1700 x 700	•	•	•	•	•	•
RDT17080/P	1700 x 800	•	•	•	•	•	•	
Mantis 	MTS9090	900 x 900						
	MTS100100	1000 x 1000	•	•	•	•	•	•
	MTS12070	1200 x 700	•	•	•	•	•	•
	MTS12080	1200 x 800	•	•	•	•	•	•
	MTS13070	1300 x 700	•	•	•	•	•	•
	MTS13080	1300 x 800	•	•	•	•	•	•
	MTS14070	1400 x 700	•	•	•	•	•	•
	MTS14080	1400 x 800	•	•	•	•	•	•
	MTS15070	1500 x 700	•	•	•	•	•	•
	MTS15080	1500 x 800	•	•	•	•	•	•
	MTS17070	1700 x 700	•	•	•	•	•	•
MTS17080	1700 x 800	•	•	•	•	•	•	

Special and bespoke sizes available in both ranges

For a comprehensive list of all tray and dec sizes visit: impeyshowers.com or call our technical helpline: 01460 258 682

**Door options for Mantis Bath Replacement Tray, Radiate Bath Replacement Tray, Bath Replacement Tray cut to length, SL3517075 and MEN701 are only suitable if they are fitted full size (not trimmed to length).

Supreme glass shower panels

Luxury combined
with practicality

Supreme Glass Shower Panels offer a luxurious appearance, whilst also providing practical support and ease of entry to the shower, fitted on either a wetroom floor or showertray.

The 8mm safety glass panels are 2 metres high, available in 5 widths and 3 glass finishes.

They are supported by a polished aluminium column, which can be ceiling fixed, or wall braced, which offers the option of hanging a shower curtain to provide further screening. The column is secured to the floor with an innovative new fitting that requires no screws and can also be easily removed.

Designed and
manufactured to
the highest standards
for safety and
durability

LIFETIME
GUARANTEE

For full details
see back cover



AQUA-SHIELD
EASY CLEAN
FINISH

CE tested to
BS EN 14428



Supreme glass shower panel features

Designed with care in mind

User Benefits

- **EASY to Grip Pole**
Strong, rigid design for user support. Secure pole acts as additional support and offers assurance when entering the shower area
- **EASY to Clean**
Designed with clean wipe down surfaces
Internal glass seals
- **Aqua-Shield**
Protects from limescale
- **Modern Design**
2000mm high semi frameless design
Available in 3 glass finishes
- **Safety**
Toughened 8mm safety glass



Coving Profile
Available for installation on Vinyl



Telescopic Pole
Simply adjust to height, twist, lock & secure

Featuring Easy Clean safety glass

Rigid strong support

8mm glass with Aqua-Shield easy clean finish

Available in 3 glass finishes; Clear, Satin and Modesty



Tiger Fix
No drilling into tray or floor required



Installer Benefits

- Pre-drilled wall profile
- Push in Glass profile with 20mm adjustment
- Coving extension profile available
- Innovative Tiger Fix, no drilling required to secure pole to floor
- Can be fitted to either tray or Wetroom floor
- All fixings and seals provided
- Fully detailed instructions supplied
- Prompt delivery

Specifier Benefits

- Available in 5 widths
- Lifetime Guarantee
- CE compliant to BS EN 12150
- Available in Clear, Satin & Modesty finishes
- Coving extension profile available for Vinyl floors
- No breaching of the floor required to fix the pole, protects against water ingress
- Unbeatable customer service
- Bespoke service available

Supreme glass shower panel features

Options

Choices & Finishes

- 2 combinations:
Floor to ceiling or floor to wall
- Floor to wall with option curtain
- Satin and Modesty options
- Bespoke service available
- Available in 700mm, 800mm, 900mm, 1000mm, 1200mm widths

Shower Curtains

- White 100% polyester
- CIBA antibacterial and fundah protection
- Machine washable
- Weighted hem



Alternative wall braced fixing available in plain glass only, with optional shower curtain

Wall braced with plain glass

Size: 700mm wide	Code: ISSW70CUC
Size: 800mm wide	Code: ISSW80CUC
Size: 900mm wide	Code: ISSW90CUC
Size: 1000mm wide	Code: ISSW10CUC
Size: 1200mm wide	Code: ISSW12CUC

Shower curtains

Size: 1200mm wide	Code: ISC12
Size: 1500mm wide	Code: ISC15
Size: 1800mm wide	Code: ISC18



Ceiling mounted option in satin glass

Floor to ceiling with satin glass

Size: 700mm wide	Code: ISS70SUC
Size: 800mm wide	Code: ISS80SUC
Size: 900mm wide	Code: ISS90SUC
Size: 1000mm wide	Code: ISS10SUC
Size: 1200mm wide	Code: ISS12SUC

Floor to ceiling with plain glass

Size: 700mm wide	Code: ISS70CUC
Size: 800mm wide	Code: ISS80CUC
Size: 900mm wide	Code: ISS90CUC
Size: 1000mm wide	Code: ISS10CUC
Size: 1200mm wide	Code: ISS12CUC



Ceiling mounted option in modesty panel glass

Floor to ceiling with modesty panel glass

Size: 700mm wide	Code: ISS70SM1C
Size: 800mm wide	Code: ISS80SM1C
Size: 900mm wide	Code: ISS90SM1C
Size: 1000mm wide	Code: ISS10SM1C
Size: 1200mm wide	Code: ISS12SM1C

LIFETIME
GUARANTEE

MADE IN
BRITAIN

For full details
see back cover

Please note: For areas where a covered vinyl floor has been installed you will need to order a coving extension profile Code: ICEP2000

Shower seats & grab rails

For added safety and comfort

All of our seats can be fitted at varying heights, and our latest SlimFold options can support up to 300kg. For added safety, we offer a wide selection of grab rails, including our unique and innovative Maxi-Grip range.



The innovative Maxi-Grip Plus grab rail system

NEW Slimfold Horseshoe shower seat

Slim, strong and
easy to clean

Can support
up to 300kg
(47 stone)

Slimfold Horseshoe provides comfort, strength and assurance designed specifically for users who require support and extra assistance of bathing for areas of the body which are harder to reach.



- Personal cleaning with ease; horseshoe access, provides easy cleaning to intimate areas of the body
- Safe and secure; unique folding mechanism prevents the seat from accidentally dropping down
- Slim design; fits closely to the shower wall - only protruding 114mm when folded
- Hygienic and easy to clean; solid surfaces with no dirt traps
- Seat can be mounted as low as 417mm
- Easy to use fold down mechanism; simply pull out the front edge, the rear seat will slide down and the arms will fold neatly into place
- High quality corrosion resistant stainless steel which can support up to 300kg

Lowest seat on the
market at 415mm high
from the ground



Horseshoe access
provides easy access for
personal cleaning

Top of the
seat is angled
back at 4° to
allow water
to run off
the back

Available in a range of colours



N.B. Colours are as accurate as the printing process will allow.

Slimfold Horseshoe seat†

The most stylish, and practical shower seat on the market

Horseshoe version of the popular Slimfold seat addresses issues for personal intimate cleaning where standard seats restrict access.

The Slimfold Horseshoe seat is designed to replace the current stark, cumbersome and prehistoric looking healthcare seats currently available and specified by TOs' and OTs'

People with the need for adaptive care will find the current offerings available; heavy, intrusive when stored and hard to clean, the Slimfold Horseshoe design eliminates these issues and more with clever thought, research and design.

Incorporating covered fixings, hidden hinges and with the unique way the seat folds and stows, the Slimfold is easy to clean and reduces areas where bacteria can build up that could lead to infection. The seat neatly sits a mere 114mm compared to 200mm plus for standard offerings off the wall when stowed, with no pultruding edges to catch the user and eliminating the risk of falling down and causing injury

*Independently tested to BS12182 and BS12727. Patent application No.1202993.0
†Fixings not included

LIFETIME
GUARANTEE

For full details
see back cover



When folded you see the stylish top of the seat, rather than the underside. This is also safer, because it cannot accidentally drop down if knocked.

Seat colour options
Sky Blue Code: SFHS250WSB
White Stone Code: SFHS250WWS
Grey Code: SFHS250WGY

Easy to install



- One unit straight out of the box
- Fittings mounting template included
- Comprehensive fittings guide supplied
- Fitting instructions included
- Technical information included

SlimFold Horseshoe seat dimensions

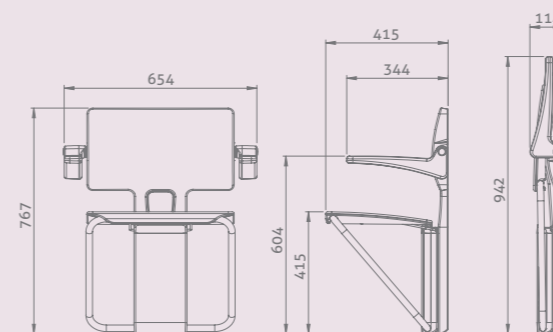

Easy to fold down mechanism

To deploy it you simply pull out the front edge so that the rear of the seat slides down and the arms then fold neatly into place.

The top of the seat is angled at 4° so that water runs off the back.

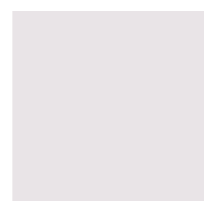
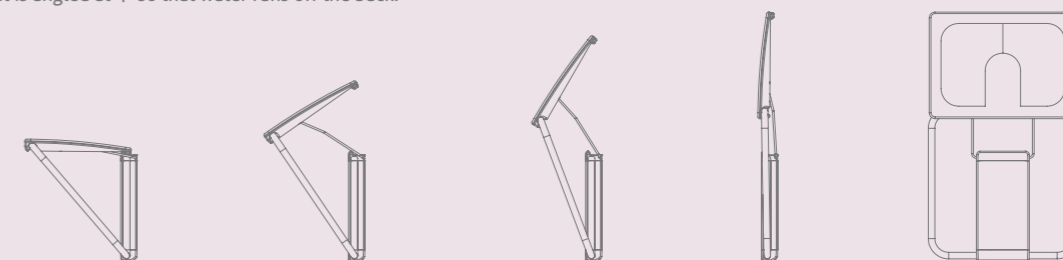

Slimfold shower seat and bench

Slim, strong and easy to clean

Designed for added safety and comfort all of our shower seats can be fitted at varying heights on the shower wall. For added safety we offer a wide selection of hand rails, including the unique and innovative Maxi-Grip range.

Can support up to 300kg (47 stone)

Smart looking bench and seat options available

LIFETIME GUARANTEE

For full details see back cover

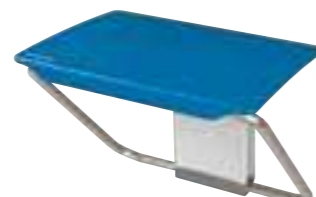

- Bench version only protrudes 68mm
- Slim design fits closely to the shower wall - only protruding 114mm when folded
- Hygienic and easy to clean. Solid surfaces with no dirt traps
- Seat can be mounted as low as 417mm
- Easy to use fold down mechanism. Simply pull out the front edge, the rear seat will slide down and the arms will fold neatly into place
- High quality corrosion resistant stainless steel which can support up to 300kg

Rounded, smooth seats made from flexible polyethylene provide natural padding as well as being comfortable and warm to the touch

Cross bracing supports add strength and aid easy access

Available in a range of colours



Top of the seat is angled back at 4° to allow water to run off the back



Slimfold shower seat and bench†

The most stylish shower seat on the market

The new SlimFold shower seat is available either as a simple bench, or full seat with a backrest and arms.

When folded the seat has a projection of only 114mm and the bench is even slimmer with a projection of only 68mm, plus you see the stylish top of the seat, rather than the underside. This is also safer, because it cannot accidentally drop down if knocked. To deploy it you simply pull out the front edge so that the rear of the seat slides down and the arms then fold neatly into place.

Using cross bracing wall supports, instead of traditional floor standing legs, prevents the risk of trapping your toes or banging your feet, or of excessive weight on the legs damaging the floor. It also allows you to mount the seat as low as 417mm if required and the top is slightly angled so that water runs off the back.

The rounded and smooth seat is comfortable, feels warm to the touch and is easy to use. This revolutionary design, made in Britain using high quality corrosion resistant stainless steel, can support up to 300kg* (47 stone).

*Independently tested to BS12182 and BS12727. Patent application No.1202993.0
†Fixings not included

Bench colour options

**LIFETIME
GUARANTEE**

For full details see back cover



Sky Blue Code: SFB250WSB



Grey Code: SFB250WGY



Black Granite Code: SFB250WBG



Sandstone Code: SFB250WSS



White Stone Code: SFB250WWS



Seat colour options
 Sandstone Code: SFS250WSS
 Black Granite Code: SFS250WBG
 Sky Blue Code: SFS250WSB
 White Stone Code: SFS250WWS
 Grey Code: SFS250WGY

When folded you see the stylish top of the seat, rather than the underside. This is also safer, because it cannot accidentally drop down if knocked.



SlimFold seat dimensions

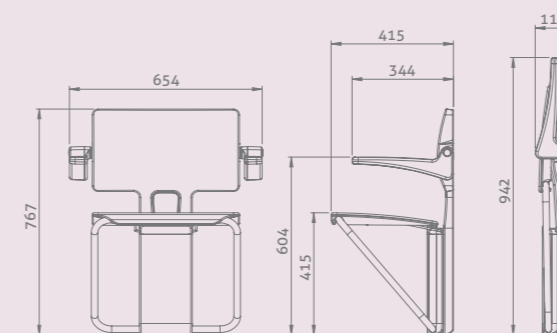

SlimFold bench dimensions

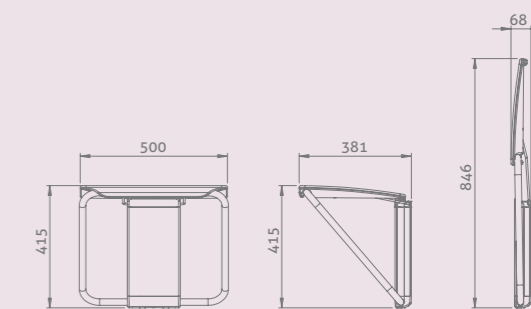

Easy to fold down mechanism

To deploy it you simply pull out the front edge so that the rear of the seat slides down and the arms then fold neatly into place.

The top of the seat is angled at 4° so that water runs off the back.

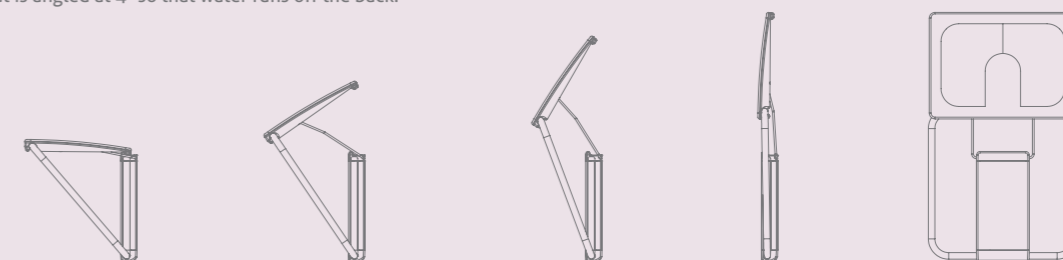

Shower seats

All of our seats are robust, can be fitted at varying heights and have durable powder coated frames. Several also have detachable vinyl seat covers (as indicated) for ease of cleaning.

The seats carry a maximum weight limit of 30 stone (190 kg) unless stated otherwise. Some seats from the range require minimal assembly.

**LIFETIME
GUARANTEE**

For full details see back cover

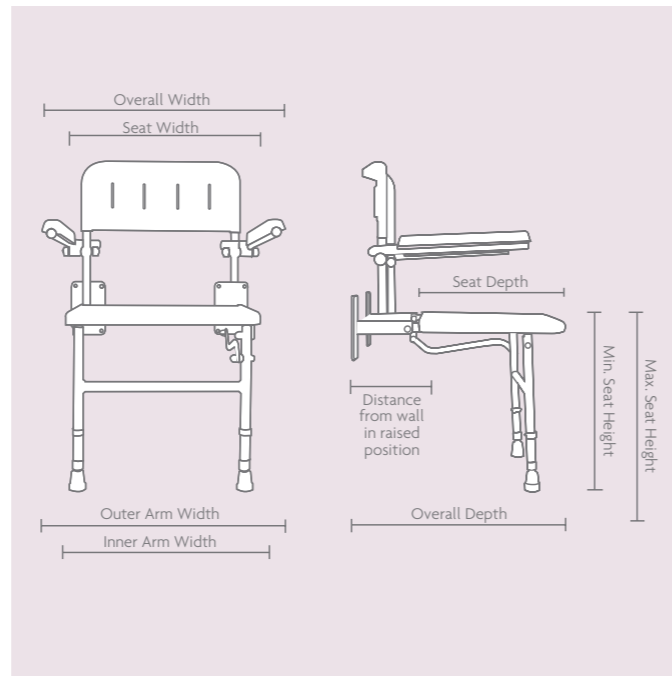

Deluxe Fold Down Shower Seat
CODE: S1
Overall Size: W595 x D545mm
Seat Size: W490 x D380 x H440-590mm
Arm Size: W490 (inner) x W595mm (outer)
Distance from wall in raised position: 215mm
Maximum Weight Limit: 30 stone (190kg)



Deluxe Padded Fold Down Shower Seat
CODE: S1/P
Overall Size: W595 x D545mm
Seat Size: W490 x D380 x H465-615mm
Arm Size: W490 (inner) x W595mm (outer)
Distance from wall in raised position: 215mm
Maximum Weight Limit: 30 stone (190kg)

Detachable seat covers



Fold Down Shower Seat
CODE: S2
Overall Size: W490 x D470mm
Seat Size: W460 x D380 x H460-540mm
Distance from wall in raised position: 98mm
Maximum Weight Limit: 30 stone (190kg)



Padded Fold Down Shower Seat
CODE: S2/P
Overall Size: W490 x D470mm
Seat Size: W460 x D380 x H485-565mm
Distance from wall in raised position: 100mm
Maximum Weight Limit: 30 stone (190kg)

Detachable seat covers



Deluxe Horseshoe Padded Fold Down Shower Seat
CODE: S1/HP
Overall Size: W610 x D558mm
Seat Size: W437 x D378 x H510-555mm
Arm Size: W505 (inner) x W610mm (outer)
Distance from wall in raised position: 175mm
Maximum Weight Limit: 25 stone (160kg)



Horseshoe Padded Fold Down Shower Seat
CODE: S2/HP
Overall Size: W500 x D470mm
Seat Size: W440 x D380 x H505-585mm
Distance from wall in raised position: 90mm
Maximum Weight Limit: 25 stone (160kg)



Wide Padded Fold Down Shower Seat
CODE: S9
Overall Size: W650 x D510mm
Seat Size: W590 x D420 x H510-580mm
Distance from wall in raised position: 100mm
Maximum Weight Limit: 30 stone (190kg)



Freestanding Shower Chair
CODE: S5
Overall Size: W535 x D505mm
Seat Size: W440 x D380 x H480-605mm
Distance from wall in raised position: 100mm
Maximum Weight Limit: 15 stone (100kg)

Detachable seat covers



Freestanding Shower Stool
CODE: S6
Overall Size: W510 x D365mm
Seat Size: W395 x D265 x H470-615mm
Distance from wall in raised position: 100mm
Maximum Weight Limit: 30 stone (190kg)



Compact Padded Fold Down Shower Seat
CODE: S4
Overall Size: W360 x D340mm
Seat Size: W360 x D280 x H500-575mm
Distance from wall in raised position: 65mm
Maximum Weight Limit: 15 stone (100kg)

Maxi Grip Plus grab rails

A unique and innovative design that redefines what a grab rail should be



- Uses a square aluminium box section a reinforcement for maximum strength
- Supports up to 150kg
- Options for 90, 60, 45 or 30 degree angles
- Modular kits available allowing installers to deliver customised installations

Unique co-polymer extrusion gives the corner of the rails soft tactile qualities for increased grip and comfort in wet environments

Square design makes the rail easier to grip firmly and less likely to rotate

- Available in 1.8m lengths that can be cut to size
- Can be used for internal or external corners
- Four point wall fixing and flared brackets reduce the stress points creating a secure fixture

Developed with the help of the RNIB, colour contrast inserts to help the partially sighted locate the grab rail

Customizable kits



Aluminium core for maximum strength

LIFETIME GUARANTEE

For full details see back cover

Maxi-grip

Maxi-Grip hand rails are an innovation from Impey and have been developed with the help of the RNIB.

The square profile improves slip resistance, whilst the unique co-polymer extrusion of Maxi-Grip Plus gives the corners of the rails a soft tactile quality for increased grip and comfort.

Maxi-Grip can support loads of upto 150kg*. The range also includes options for 90°, 60°, 45° or 30° angles plus internal and external corners.

*Refers to rails only, not fixings



LIFETIME GUARANTEE

For full details see back cover

Maxi-Grip with 90° Angle



Maxi-Grip Hand Rail (White)

- Size: 300mm Code: IGC30W
- Size: 450mm Code: IGC45W
- Size: 600mm Code: IGC60W
- Size: 900mm Code: IGC90W

Maxi-Grip Adjustable Angle

- Angle: 45° White Code: IGA45W
- Angle: 90° White Code: IGA90W

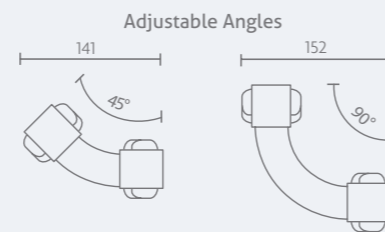
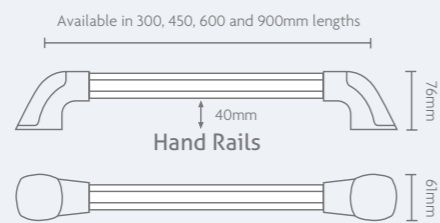

Maxi-grip plus

Maxi-Grip Plus with 45° Angle



The 90° Adjustable Angle can be trimmed to 60°, 45° & 30° and the 45° can be trimmed to 30°

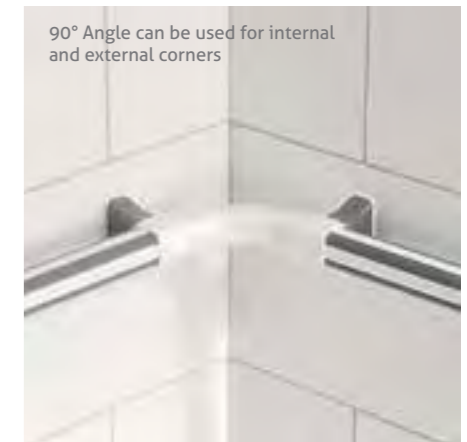

90° Angle can be used for internal and external corners

Maxi-Grip Plus Hand Rail (White/Grey)

- Size: 300mm Code: IGS30G
- Size: 450mm Code: IGS45G
- Size: 600mm Code: IGS60G
- Size: 900mm Code: IGS90G

Maxi-Grip Plus Adjustable Angle

- Angle: 45° White/Grey Code: IGA45G
- Angle: 90° White/Grey Code: IGA90G

Maxi-Grip Plus Modular Kits

Maxi-Grip Plus provides installers with the ability to provide customised installations with multi-packs of rails, brackets and angle brackets that can be trimmed to size and angled on-site.

- 1.8m Hand Rail: pack of 4 Code: MGRG184
- 1.8m Hand Rail: pack of 10 Code: MGRG1810
- End Brackets: pack of 4 Code: MGEGB4
- End Brackets: pack of 10 Code: MGEGB10
- Trimmable Angles: pack of 4 Code: MGCG4
- Trimmable Angles: pack of 10 Code: MGCG10

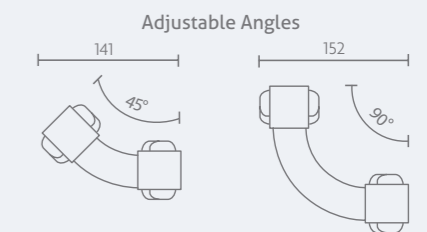

Fluted hand rails

Engineered from industrial strength plastics, our satin finished fluted hand rails provide exceptionally good grip in wet environments.

Five screw points on each elbow ensure secure and easy wall fixing, with screw cover plates that snap on easily to provide a neat, easy to clean finish.

**LIFETIME
GUARANTEE**

For full details see back cover



White Hand Rails

Size: 300mm Code: IG1F
 Size: 450mm Code: IG4F
 Size: 600mm Code: IG5F
 Size: 900mm Code: IG6F

Blue Hand Rails

Size: 300mm Code: IG1F/Blue
 Size: 450mm Code: IG4F/Blue
 Size: 600mm Code: IG5F/Blue

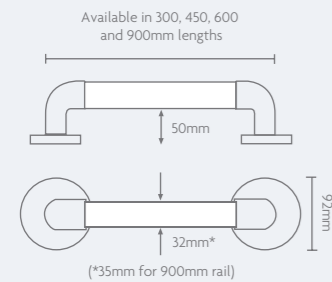

Angular Hand Rails (white only)

Size: 450mm Code: IG7
 Size: 600mm Code: IG8

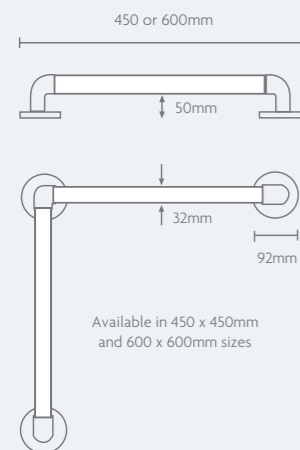

Floor to Ceiling Pole (white only)

Code: FCP1

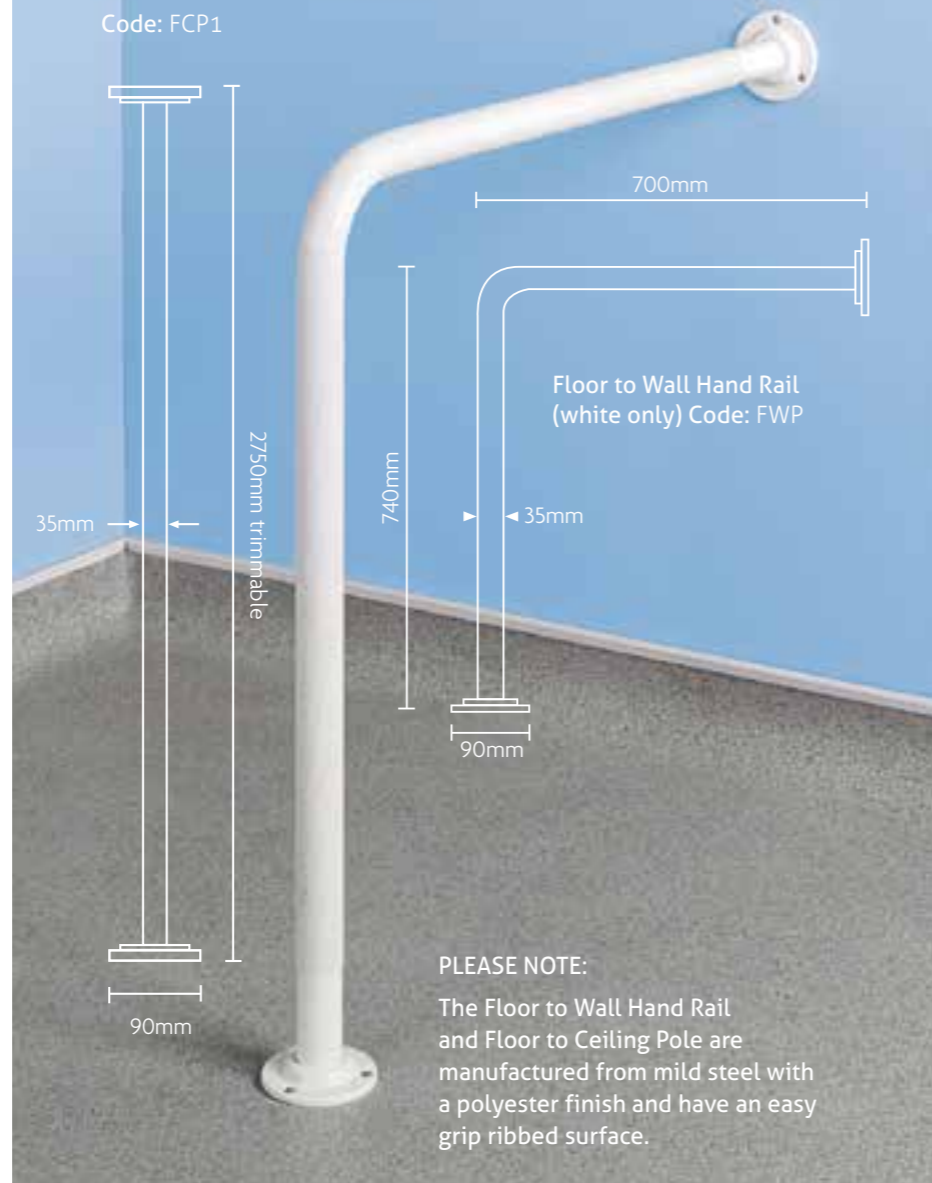

Floor to Wall Hand Rail (white only) Code: FWP

PLEASE NOTE:

The Floor to Wall Hand Rail and Floor to Ceiling Pole are manufactured from mild steel with a polyester finish and have an easy grip ribbed surface.

Fold down rails



We have a large range of fold down rails to offer more assistance in the bathroom. Our robust powder coated rails are available in a variety of sizes and have additional optional extras including toilet roll holders and support legs.

The fold down rails are perfect next to your WC, offering that little extra support when required. Only available in white.

**LIFETIME
GUARANTEE**

For full details see back cover

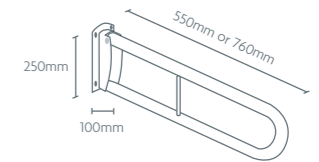

Fold Down Rails

Size: 550mm Code: DR1
 Size: 760mm Code: DR2
 Size: 760mm (with Toilet Roll Holder) Code: DR7
 Load Rating 170kg* (26.5 Stone)

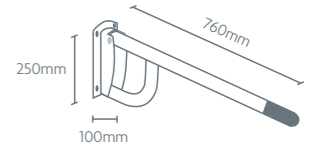

Fold Down Single Rail

Size: 760mm Code: DR9
 Load Rating 130kg* (20.5 Stone)

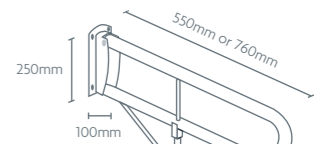

Fold Down Rails (with supporting leg)

Size: 550mm Code: DR5
 Size: 760mm Code: DR6
 Size: 760mm (with Toilet Roll Holder) Code: DR8
 Load Rating 200kg* (31.5 Stone)
 Overall height to top of rail adjustable to 680mm, 700mm and 750mm

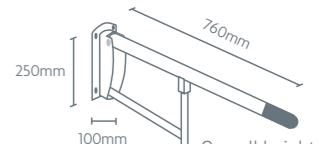

Fold Down Single Rail (with supporting leg)

Size: 760mm Code: DR10
 Load Rating 200kg* (31.5 Stone)
 Overall height to top of rail adjustable to 680mm, 700mm and 750mm

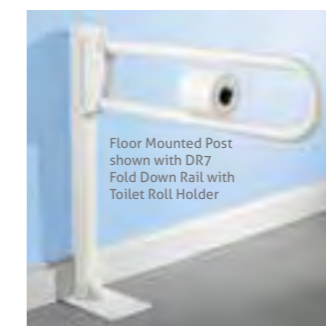

Floor Mounted Post shown with DR7 Fold Down Rail with Toilet Roll Holder

Floor Mounted Post (to suit any hinged rail)

Code: DR3

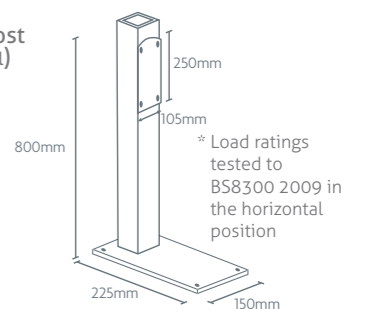

Drainage

- Easy to fit
- Intelligence of design
- Durability



Making
installation
even easier

LIFETIME
GUARANTEE

For full details
see back cover



Drainage options for vinyl wetroom floors

All Level-Dec EasyFit floor formers are supplied as standard with a UTVG01/H horizontal outlet with a grey cover and clamping ring. The alternative options are available at extra cost. Please specify when ordering.

Horizontal outlet (supplied as standard)

With grey cover and clamping ring Code: UTVG01/H
With chrome cover and clamping ring Code: UTVC01/H

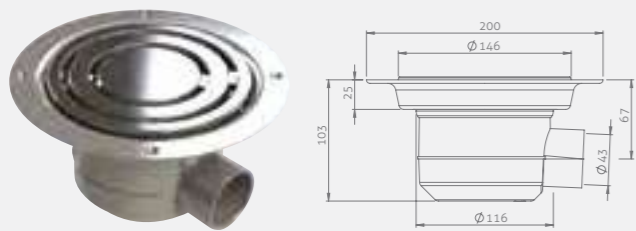

Available with either grey or chrome cover and clamping ring

Vertical outlet

With grey cover and clamping ring Code: UTVG01/V
With chrome cover and clamping ring Code: UTVC01/V

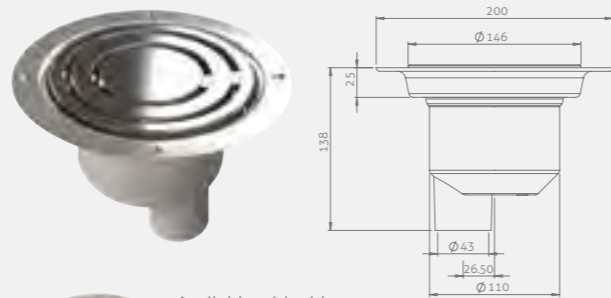

Available with either grey or chrome cover and clamping ring

Horizontal outlet

Code: TSG1
Additional charges apply

75mm waterseal with a 50mm outlet and a 40mm reducer

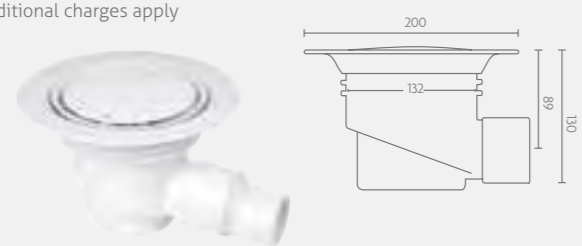

Slimline waste

Code: SLW1

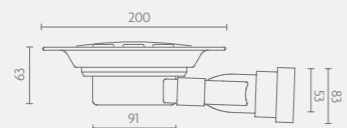

A waterless trap with a removable one way silicone seal

Vertical outlet

Code: TSG2
Additional charges apply

75mm waterseal with a 110mm outlet and a 50mm reducer



For pumped waste

With grey cover and clamping ring Code: TAD13
With chrome cover and clamping ring Code: TAD3/CP

Available with either grey or chrome cover and clamping ring



Designed for use with a shower waste pump.

Impey Bath Adapter for Lifetime Homes

Making installation even easier

The government initiative to provide sustainable homes means that those involved with the development of new housing need to consider the impact, both on the environment and the changing needs of the tenant. The lifetime homes standard will become a mandatory part of the code for sustainable homes and one of the criteria to meet this standard is the provision of drainage that enables a shower to be fitted in the future.

The Impey bath adapter allows you to install a wetroom floor, with a bath above to meet the needs of tenants today, whilst allowing for a simple and economical conversion to a level access wetroom, to suit future requirements.

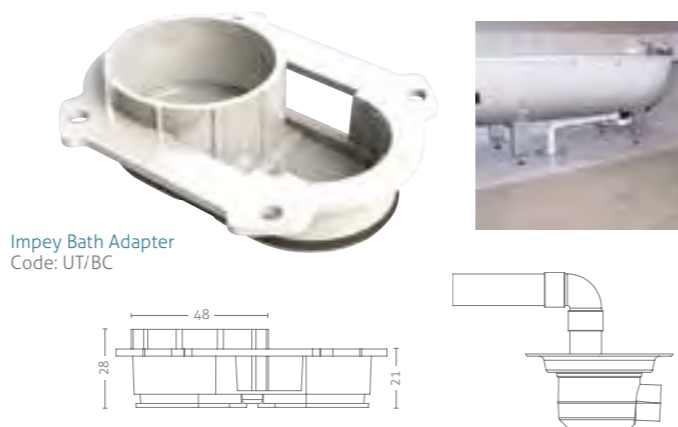

Impey Bath Adapter
Code: UT/BC

Drainage options for showertrays

All drainage options have a chrome plated top cover. The IMOR/H is supplied as standard. The alternative options are available at additional cost. Please specify when ordering.

Horizontal outlet

Code: IMOR/H

50mm water seal with a 43mm swivel joint outlet

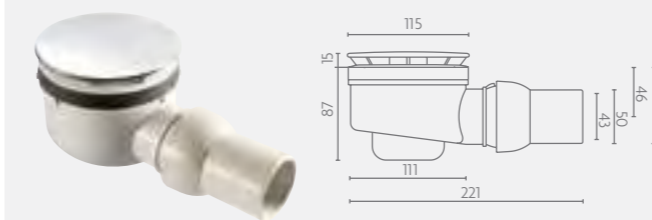

For pumped waste

Code: IMOR/P

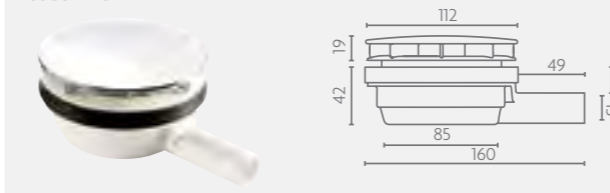

Vertical outlet

Code: IMOR/V

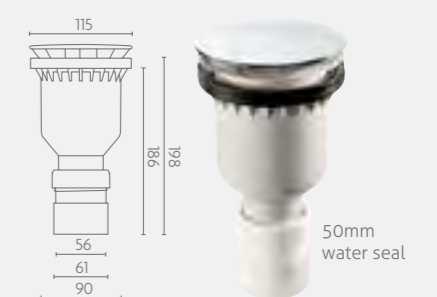

Slimline waste

Code: SLW/TTI

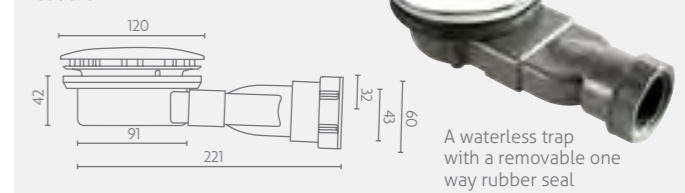

A waterless trap with a removable one way rubber seal

Drainage options for tiled wetroom floors

Tiled drainage options are not available separately and are ONLY available to be purchased with a Level-Dec EasyFit floor former and tanking membrane

Standard Tiled Drain

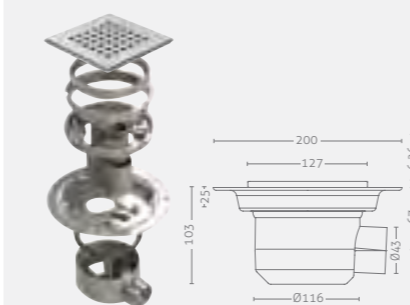

Fabric Membrane



- Co-Polymer membrane creates a completely watertight barrier
- Polypropylene surface provides a key for the tile adhesive
- Can be used with epoxy grout and solvent based sealers for stone tiles
- Pre-made corners for faster and easier installation

Stainless Steel Grate

The high quality stainless steel grate is 2.5mm thick and has a contemporary and modern design.

Height Adjustable Rings

The height adjustable rings rotate to vary the height to suit different tile depths between 6-26mm.

Membrane Clamping Ring

The membrane clamping ring secures the tanking membrane into place creating a secure watertight seal at the drainage point.

Vertical outlets and Slimline/Pumped wastes available upon request

Level-Dec and Membrane codes (standard horizontal drain included)

Size: 800 x 800 For tiled floors with Fabric Membrane 5m ² Code: LDE8080TC5 10m ² Code: LDE8080TC10	Size: 1200 x 900 For tiled floors with Fabric Membrane 5m ² Code: LDE1290TC5 10m ² Code: LDE1290TC10	Size: 1500 x 800 For tiled floors with Fabric Membrane 5m ² Code: LDE1580TC5 10m ² Code: LDE1580TC10
Size: 900 x 900 For tiled floors with Fabric Membrane 5m ² Code: LDE9090TC5 10m ² Code: LDE9090TC10	Size: 1200 x 1200 For tiled floors with Fabric Membrane 5m ² Code: LDE1212TC5 10m ² Code: LDE1212TC10	Size: 1500 x 1200 For tiled floors with Fabric Membrane 5m ² Code: LDE1512TC5 10m ² Code: LDE1512TC10
Size: 1000 x 1000 For tiled floors with Fabric Membrane 5m ² Code: LDE1010TC5 10m ² Code: LDE1010TC10	Size: 1300 x 800 For tiled floors with Fabric Membrane 5m ² Code: LDE1380TC5 10m ² Code: LDE1380TC10	Size: 1700 x 750 For tiled floors with Fabric Membrane 5m ² Code: LDE1775TC5 10m ² Code: LDE1775TC10
Size: 1200 x 750 For tiled floors with Fabric Membrane 5m ² Code: LDE1275TC5 10m ² Code: LDE1275TC10	Size: 1400 x 900 For tiled floors with Fabric Membrane 5m ² Code: LDE1490TC5 10m ² Code: LDE1490TC10	Size: 1850 x 900mm For tiled floors with Fabric Membrane 5m ² Code: LDE18590TC5 10m ² Code: LDE18590TC10

Showers

A range to suit all applications

Impey offer a wide selection of showers from a variety of manufacturers, in order to provide you with the best choice for your requirements. The entire range features thermostatic controls, for added safety, plus you have the option of the finest quality mixer shower, or easy to install electric showers.

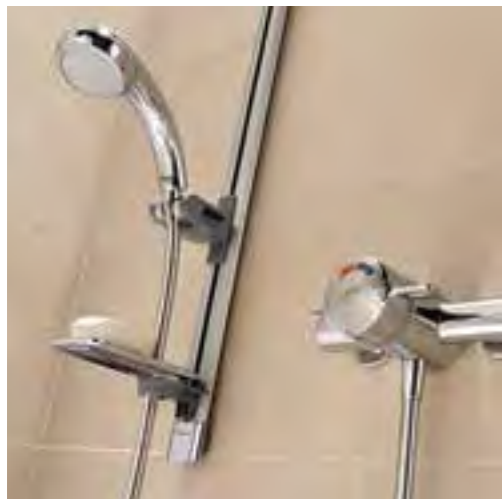

Mixers and electric showers

Mira Select Flex Thermostatic Mixer Shower

Code: MIRASELFLEX



Technical Specification

- Separate flow and temperature controls with extended levers
- Thermostatic temperature stability for safe showering of 1°C
- Adjustable maximum temperature setting for added safety
- Fail safe on hot and cold supplies
- 'Cool Touch' shower valve for added safety
- 'Everclear' limescale resistant showerhead with single spray pattern
- Extended riser rail (1m) and 2m hose
- Wall or corner mounting options
- Variable pipe inlet centres (139-153mm)
- Inlet connection: 15mm compression
- Outlet connection: ½" BSP flat face
- Operating pressure range of 0.1 to 5 bar
- Maximum inlet temperature: 65°C
- Minimum temperature differential to achieve hot or cold failsafe: 12°C
- Suitable for unvented, pressurised, combi-boiler, gravity fed and mains pressure systems
- Guaranteed for 5 years

Redring Selectronic Premier Plus

8.5kW
Code: SELP85P
9.5kW
Code: SELP95P



Technical Specification

- Separate temperature controls with large push button start/stop and audible bleeps
- Clear print control identification for ease of visibility and legibility
- Large LED temperature readout display
- Thermostatic temperature control for added safety
- Adjustable maximum temperature setting for added safety
- Eco Water-Save feature that automatically calculates and adjusts the optimum flow rate.
- Phased shutdown reduces limescale and ensures a cool start for added safety for the next user.
- Automatic shutdown after 30 minutes of inactivity
- 6 spray pattern shower head with rub clean nozzles for easy cleaning
- Extended riser rail (1m) with 2m hose
- Guaranteed for 3 years, with optional 2 year extended warranty

Mira Advance ATL Flex

9.0kW
Code: MIRAFLEX90
9.8kW
Code: MIRAFLEX98



Technical Specification

- Separate flow and temperature controls with push button start/stop and audible bleeps
- Large, colour contrasting rotary controls with raised areas to aid navigation
- LED backlit flow and on/off buttons and audible click on temperature lever
- Thermostatic temperature control for added safety
- Colour contrasting panel to aid navigation
- Adjustable maximum temperature setting for added safety
- Phased shutdown reduces limescale and ensures a cool start for added safety for the next user
- 4 spray pattern showerhead with rub clean rubber nozzles for easy cleaning
- Extended riser rail (1m) with wall or corner mounting options and easy one-handed adjustment of the height of the shower head
- Best in class limescale resistance
- Guaranteed for 2 years, with optional 3 year extended warranty

Mixers and electric showers

Mira Advance Flex Low Pressure

9.0kW
Code: MIRAFLEX/LP90



Technical Specification

- Pumped electric shower - the ideal choice for low pressure sites
- Separate flow and temperature controls with push button start/stop and audible beeps
- Thermostatic temperature control for added safety
- Four spray pattern showerhead with rub clean rubber nozzles for easy cleaning
- Extended riser rail (1m) with easy one-handed adjustment of the height of the shower head, plus additional parking socket
- Best in class limescale resistance
- Guaranteed for 2 years, with optional 3 year extended warranty

Triton Safeguard Plus Shower

8.5kW
Code: TRSGPL85
9.5kW
Code: TRSGPL95



Technical Specification

- Temperature stability thermostatic +/-1°C
- Adjustable max temp 41°C, 43°C or 47°C
- Safe-Set™ with full lever rotation (always max position '9')
- Timed auto shutdown 5, 10, 20 or 30 mins (default 20 mins)
- Start/stop type electronic soft press button
- Temperature control: large looped lever
- Tactile control(s), temperature dial & start/stop button
- Audible feedback: start/stop and timer end confirmation
- Visual indicators: power-on/timer/low flow illumination & numbered temperature dial
- Showerhead diameter 110mm, spray options: 5 patterns
- Cleaning: rub clean nozzles & removable spray plate
- Hose length 2000mm
- Riser rail length 940mm, diameter 25mm, material: stainless steel, finish: polished
- Guaranteed for 2 years, with optional 3 year extended warranty

Triton Safeguard Plus Shower Grab

8.5kW
Code: TRSGPLGB85
9.5kW
Code: TRSGPLGB95



Technical Specification

- Temperature stability thermostatic +/-1°C
- Adjustable max temp 41°C, 43°C or 47°C
- Safe-Set™ with full lever rotation (always max position '9')
- Timed auto shutdown 5, 10, 20 or 30 mins (default 20 mins)
- Start/stop type electronic soft press button
- Temperature control: large looped lever
- Tactile control(s), temperature dial & start/stop button
- Audible feedback: start/stop and timer end confirmation
- Visual indicators: power-on/timer/low flow illumination & numbered temperature dial
- Showerhead diameter 110mm, spray options: 5 patterns
- Cleaning: rub clean nozzles & removable spray plate
- Hose length 2000mm
- Riser rail length 940mm, diameter 25mm, material: stainless steel, finish: polished
- Grab riser rail, support load (max) 150kg, rail wall thickness: 3mm, fixing brackets: 5 fixing points/70mm diameter
- Showerhead holders: rail & wall mounted
- Guaranteed for 2 years, with optional 3 year extended warranty

Electric showers and waste pumps

Wireless controlled pumped drainage.

For drainage that requires a waste pump we offer a choice of five electric showers, which provide a more economical and easy to install solution. These showers can be directly connected to the waste water pump rather than fitting a separate flow switch or sensor, together with the additional wiring connections.

The latest innovation from Mira and Whale provides wireless control pumped drainage, reducing installation time and the need for additional wiring between the pump and the shower.



The easier to install solution to provide quieter pumped drainage.

1 The internal flow sensor in the Mira Advance shower measures the flow rate going to the shower head.

2 This flow rate information is sent wirelessly to the Instant Match transformer.
Maximum 5m range for wireless signal

INSTANT MATCH[®]
wireless

The flashing green light indicates successful pairing

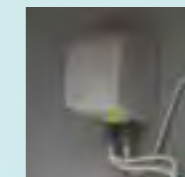

3 The Instant Match Transformer alters the speed of the pump to match the shower flow rate.

4 Matching the pump speed to the shower flow rate ensures that gully suction noise is minimised.

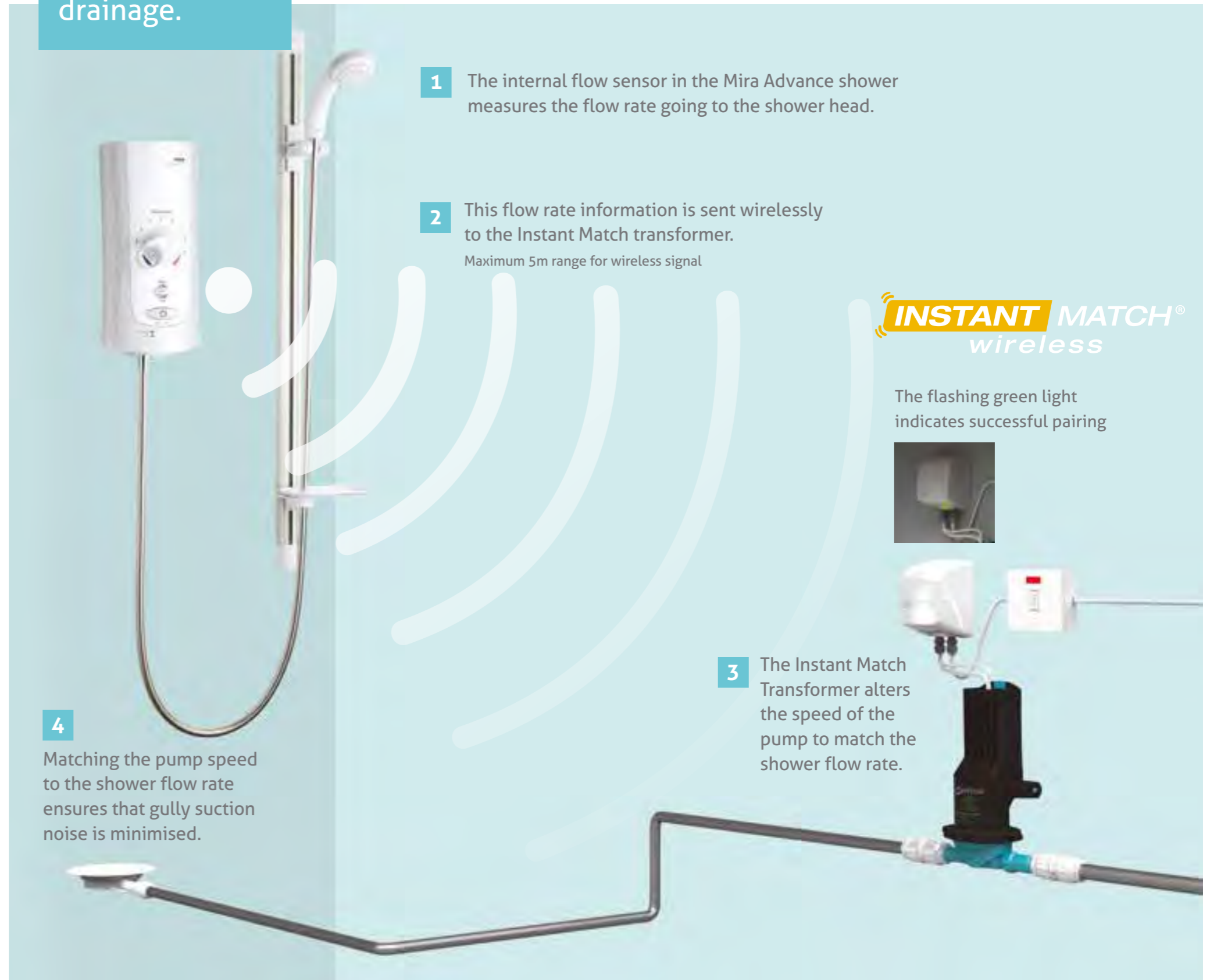

Electric showers and waste pumps

Integral sensors ensure the pump flow rate matches the shower flow rate to provide the most efficient drainage. This also reduces noise output considerably, whilst also reducing wear on the pump.

Mira Advance ATLW and Whale Instant Match Wireless Pump Kit

Shower and Pump Kit
Code: MIRIMM/Wireless

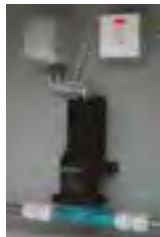

Mira Advance Flex Extra and Whale Instant Match Pump Kit

9kW
Code: MIRIMM



Redring Selectronic Electric Shower and Waste Pump Pack

8.5kW
Code: SELP85LAP
9.5kW
Code: SELP95LAP



Mira Advance Flex Extra

9kW
Code: MIRAFLEXEXTRA
9.0kW



Triton Safeguard Plus Shower Grab with Remote

8.5kW
Code: TRSGPL85R



This new kit provides the added advantage of wireless control from the shower to the pump, which reduces installation time and the need for additional wiring. The shower and pump are also available separately.

Shower only Code: MIRAFLEXEXTRA 9.0/WLESS Pump only Code: SWP/IMM



Technical Specification (Shower)

- Separate flow and temperature controls with push button start/stop and audible bleeps
- Large, colour contrasting rotary controls with raised areas to aid navigation
- LED backlit flow and on/off buttons and audible click on temperature lever
- Thermostatic temperature control for added safety
- Colour contrasting panel to aid navigation
- Adjustable maximum temperature setting for added safety
- Phased shutdown reduces limescale and ensures a cool start for added safety for the next user
- 4 spray pattern showerhead with rub clean rubber nozzles for easy cleaning
- Extended riser rail (1m) with wall or corner mounting options and easy one-handed adjustment of the height of the shower head
- Best in class limescale resistance

Technical Specification (Pump)

- The Instant Match transformer includes patented Active Link diagnostics:
 - Test Button power indicator
 - Flashing Active Link signal shows communications between the Mira shower and the Whale pump
 - Slow flash (Correct communication)
 - Fast flash (Water flowing)

Shower and Pump Approvals

- Complies with European standards for EMC (Electromagnetic Compatibility) and LVD (Low Voltage Directive)
- IP45 rated against moisture and particle ingress

Technical Specification (Shower)

- Separate flow and temperature controls with push button start/stop and audible bleeps
- Large, colour contrasting rotary controls with raised areas to aid navigation
- LED backlit flow and on/off buttons and audible click on temperature lever
- Thermostatic temperature control for added safety
- Colour contrasting panel to aid navigation
- Adjustable maximum temperature setting for added safety
- Phased shutdown reduces limescale and ensures a cool start for added safety for the next user
- 4 spray pattern showerhead with rub clean rubber nozzles for easy cleaning
- Extended riser rail (1m) with wall or corner mounting options and easy one-handed adjustment of the height of the shower head
- Best in class limescale resistance

Technical Specification (Pump)

- Maximum drainage 8 l/min
- Self priming pump with protective cover
- Low voltage transformer conforms to EN60742
- IP 45 rated
- Active Link Diagnostics
- 3 year guarantee extendable to 5 years with free registration



This is the only shower to meet the requirements of the Disability Discrimination Act (DDA).



Technical Specification

- Separate temperature controls with large push button start/stop and audible bleeps
- Clear print control identification for ease of visibility and legibility
- Large LED temperature readout display
- Thermostatic temperature control for added safety
- Adjustable maximum temperature setting for added safety
- Eco Water-Save feature that automatically calculates and adjusts the optimum flow rate
- Phased shutdown reduces limescale and ensures a cool start for added safety for the next user
- Automatic shutdown after 30 minutes of inactivity
- 6 spray pattern shower head with rub clean nozzles for easy cleaning
- Extended riser rail (1m)
- Additional time delay adjustment for pump start-up & over-run
- Minimal maintenance - diaphragm pump action removes residual shower waste (hair, grit, gel) without blocking

Compatible with Whale Instant Match Pump Kit SWP/IMM (see page 92).



Technical Specification

- Separate flow and temperature controls with push button start/stop and audible bleeps
- Large, colour contrasting rotary controls with raised areas to aid navigation
- LED backlit flow and on/off buttons and audible click on temperature lever
- Thermostatic temperature control for added safety
- Colour contrasting panel to aid navigation
- Adjustable maximum temperature setting for added safety
- Phased shutdown reduces limescale and ensures a cool start for added safety for the next user
- 4 spray pattern showerhead with rub clean rubber nozzles for easy cleaning
- Extended riser rail (1m) with wall or corner mounting options and easy one-handed adjustment of the height of the shower head
- Best in class limescale resistance

Technical Specification

- Temperature stability thermostatic +/-1°C
- Adjustable max temp 41°C, 43°C or 47°C
- Safe-Set™ with full lever rotation (always max position '9')
- Timed auto shutdown 5, 10, 20 or 30 mins (default 20 mins)
- Start/stop type electronic soft press button
- Temperature control: large looped lever
- Tactile control(s), temperature dial & start/stop button
- Audible feedback: start/stop and timer end confirmation
- Visual indicators: power-on/timer/low flow illumination & numbered temperature dial
- Showerhead diameter 110mm, spray options: 5 patterns
- Cleaning: rub clean nozzles & removable spray plate
- Hose length 2000mm
- Riser rail length 940mm, diameter 25mm, material: stainless steel, finish: polished
- Grab riser rail, support load (max) 150kg, rail wall thickness: 3mm, fixing brackets: 5 fixing points/70mm diameter
- Showerhead holders: rail & wall mounted
- Guaranteed for 2 years, with optional 3 year extended warranty
- Remote Start/Stop, button type: electronic soft press, visual indicators: power-on illumination, power 24V, flying lead 5m supplied

Impey TMV2 & TMV3 kit

Impey TMV2 Kit

Mixer bar shower with extra-long riser rail, hose and head pack



TMV2 approved thermostatic bar shower. The shower has been specifically designed and tested to be suitable for both high and low pressure applications: EN1111 – High Pressure, EN1287 – Low Pressure. It has been independently tested and approved by Buildcert as meeting the requirements of the TMV2 scheme.



Impey TMV2 Kit
Code: TMV2KIT

- Suitable for use with unvented supplies, combi boilers, gravity and mains pressure systems
- Thermal cartridge technology
- Temperature stability of $\pm 2^{\circ}\text{C}$
- Fail safe protection on both the hot and cold supplies
- Operating pressure range of 0.2 to 5 bar
- TMV2 / WRAS approved
- 5 year warranty

Impey TMV3 Kit

(Safe touch body)

Mixer bar shower with extra-long riser rail, hose and head pack



TMV3 approved thermostatic bar shower with safe touch technology. The shower has been specifically designed and manufactured to meet the general requirements National Health Service Model Engineering Specification - Thermostatic Mixing Valves - Health Premises - D08 and BS 7942: 2000 Thermostatic Mixing Valve for use in care establishments (TMV3). It has been independently tested and approved by Buildcert as meeting the requirements of the TMV3 scheme



Impey TMV3 Kit
Code: TMV3KIT

- Suitable for use with unvented supplies, combi boilers, gravity and mains pressure systems
- Thermal cartridge technology
- Temperature stability of $\pm 2^{\circ}\text{C}$
- Fail safe protection on both the hot and cold supplies
- Operating pressure range of 0.2 to 5 bar
- Safe touch body
- TMV3 / WRAS approved - complies with NHS D08 and BS7942
- 5 year warranty

Less Abled Shower Kit & Extractor fans

Less Abled Shower Kit

900mm grab rail with handset holder

- Sliding handset holder
- Concealed fixings

Less Abled Shower Kit
Code: GR90032WHI
(Shower hose and head are not included)

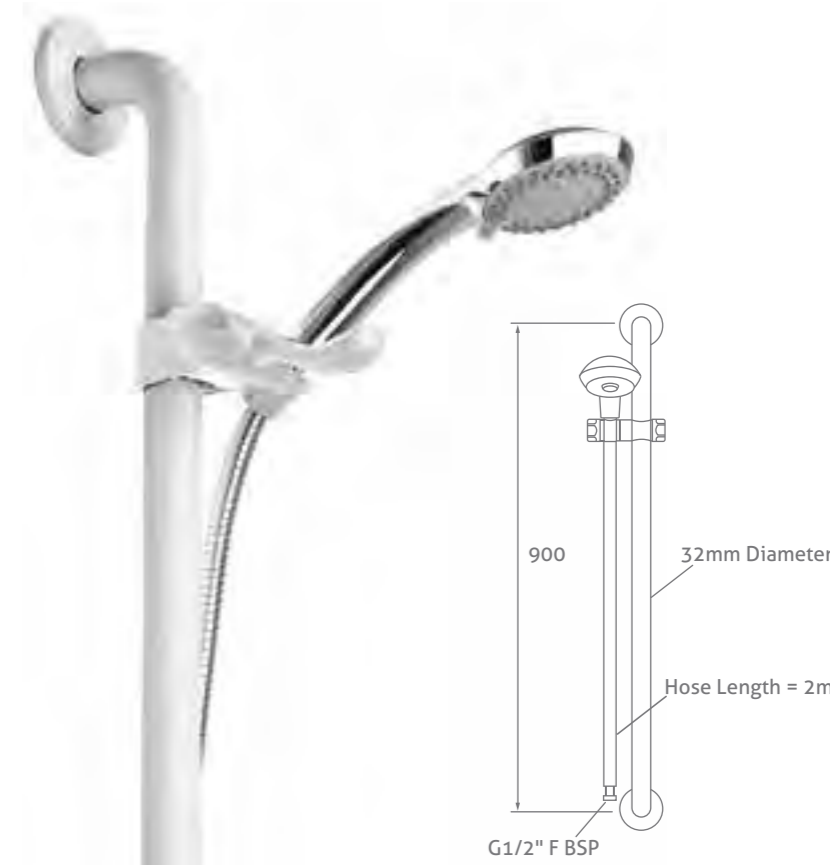

Impey Simply Silent Range

Two speed, silent, intermittent timer fan

For ease of installation:

- Strengthened ducting reduces duct distortion on fitting and avoids breakage
- Large cable access for ease of wiring
- Front cover is easy to remove or replace
- To replace - hook at top, rotate, press and clip back into place
- Notch to remove cover with tool - no screws

Our Simply Silent Fans are silent, intermittent timer fans which are suitable for wall, ceiling, window and panel mounting. Incorporating Ghost Airflow Technology which offers all of the following benefits.

- Flow straighteners guide air through ducting which reduces turbulence, smoothing and making the air flow laminar
- A cone reduces turbulence in front of the fan and air is directed straight into the impellor
- Ball-bearing motors suppress noise from the motor

Round/Square Intermittent bathroom fan
Code: C4R/S

Round/Square Intermittent bathroom fan with timer
Code: C4TR/S

Round/Square Intermittent bathroom fan with pull cord
Code: C4PR/S

Round/Square Intermittent bathroom fan with Humidistat
Code: C4HTR/S

Round /Square DC Low Voltage Constant Volume bathroom fan with external transformer
Code: LVCV4 R/S

Simply Silent Wall Kit
Code: SSWKWR/S

Simply Silent Window Kit
Code: SSWIN



Simply Silent Contour CV
Available as a round (CV4R) or square fan (CV4S)



Impey Simply Silent Illumi Single speed
Code: 93087AW

Pumped drainage

Shower Waste Pump Kits can be fitted when gravity drainage is not an option. The pump is activated by a flow switch installed in the water supply to the shower.

When the shower is turned on water passes through the flow switch, activating the pump. Alternatively we offer one pump that is controlled directly by a connection to an electric shower, without the need for a flow switch.

All our pumped kits are suitable for wetroom floors or showertrays and include all the fittings needed for a single feed electric shower installation, but please note that for mixer showers you will need a Mixer Shower Conversion Kit (see below) and for wetfloors you will require a TAD13 shallow waste gully (see page 80).



Whale Smoothflow Shower Waste Pump Kit

Code: SWP/SFC

Quiet operation, because the speed is regulated depending on the flow rate of water from the shower. This reduces noise output considerably, whilst also reducing wear on the pump.

Technical Specification

- Automatically adjusts to changes in shower flow rate
- Compensates for changes in voltage from main electric supply
- Maximum drainage 12l/min
- Additional flow sensor is required for mixer showers
- Self priming pump with protective cover
- Low voltage transformer conforms to EN60742
- IP45 Rated
- 3 year guarantee extendable to 5 years with free registration



Pump Service Kit

Code: SWP/DT

Suitable for:

- Impey Whale shower waste pump Ref: SWP
- Impey Whale Smoothflow pump Ref: SWP/SFC
- Impey Digital shower waste pump Ref: IDP



Also includes two 22mm push-fit fixtures

Mixer Shower Conversion Kit for SWP Pump

Code: SWP/MX

When fitting the pump in conjunction with a mixer shower this mixer shower conversion kit is required.

Suitable for:

- Impey Whale shower waste pump Ref: SWP



Mixer Shower Flow Sensor Venturi for SWP/SFC

Code: SWP/SFSMK2

When fitting the pump in conjunction with a mixer shower an additional flow sensor is required.

Suitable for:

- Impey Whale Smoothflow pump Ref: SWP/SFC



Whale Switch Connect Kit

Code: SWP

This is the original waste pump kit and has been successfully installed in over 150,000 homes across the UK.

Technical Specification

- Maximum drainage for electric showers 8l/min
- Maximum drainage for mixer showers 12ltrs per minute (additional mixer valve conversion kit required) SWP/MX
- Self priming pump with protective cover
- Low voltage transformer conforms to EN60742
- 12 adjustable settings for electric & mixer showers
- Active link diagnostics
- Variable speed settings for electric & mixer showers
- De-puddling cycle: pump turns on for a brief period, 15 min after shower is turned off
- IP45 Rated
- 3 year guarantee extendable to 5 years with free registration



Whale Instant Match Kit

Code: SWP/IMM

Designed to be specifically compatible with the Mira Flex Extra and the Triton Safeguard Care Digilink Electric Showers (shown on page 89). A digital signal from the shower automatically adjusts the pump speed in relation to the shower flow rate.

Technical Specification

- Maximum drainage 8 l/min
- Self priming pump with protective cover
- Low voltage transformer conforms to EN60742
- IP 45 rated
- Active Link Diagnostics
- 3 year guarantee extendable to 5 years with free registration



15mm Flow Switch Kit

Code: SWPFS

Suitable for:

- Impey Whale shower waste pump Ref: SWP



Spare Pump Head

Code: SWP/PH

Suitable for:

- All Impey Whale shower waste pumps



Spare Pump Only

Code: SWP/PO

Suitable for:

- Replacement of all Impey Whale shower waste pumps



Pump Transformers

Code: SWP/TMK2

Suitable for:

- Whale Switch Connect Kit Code: SWP



Pump Transformers

Code: SWP/IMT

Suitable for:

- Whale Instant Match Kit Code: SWP/IMM

Automatic shower toilets

The Clos-o-Mat Palma Vita Automatic WC shower toilet provides flushing, washing and warm air drying from one simple operation. It is user-friendly for people who have restricted use of their hands. By reducing hand contact, it also provides improved hygiene for all users.



Simultaneous flushing and washing

This unique feature improves personal hygiene - cleaning with water not paper. Can be used at all times as a conventional WC.

Combines functions of a WC and bidet with addition of drying air. UK made in a dedicated plant. Clos-o-Mat's unique one touch system allows the user to benefit from the toilet's automatic functions by just pressing and releasing the flush. Wash time adjustable to client needs.

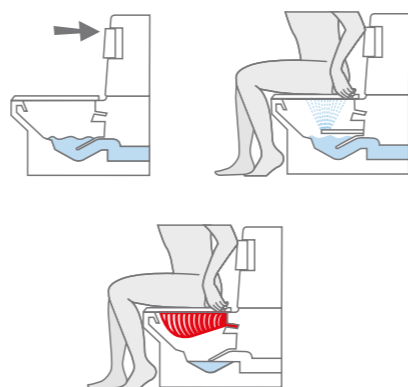

Accessories

There is a range of accessories available for the Palma Vita automatic WC including seats, integrated fold down support arms, lateral body supports, plinths to raise the height and a touch pad for those who cannot use the flush button.

For more information on these accessories please call us on 01460 256090.

Fold Down Single Rail

Size: 760mm Code: DR9
Load Rating 130kg* (20.5 Stone)

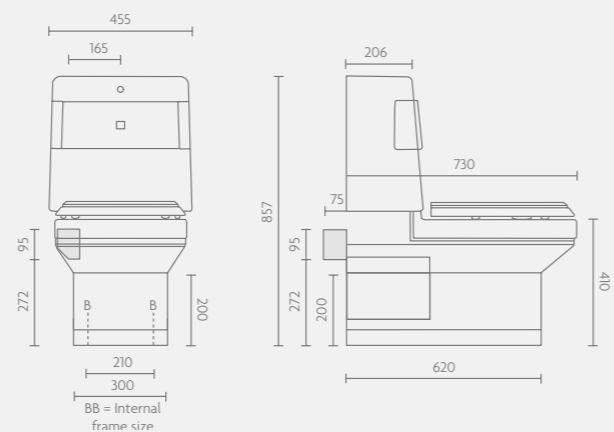

Toilet plinths

For wheelchair users and people with limited mobility conventional toilets can be too low and very difficult to use.

The Impey toilet plinths have been designed to raise the existing toilet to account for these needs. Their non-intrusive design allows for greater flexibility in the bathroom and removes the need to purchase a new toilet while remaining discreet.

Back to Wall Plinths also available.



25mm Toilet Plinth Code: IP25
Raises the height of the toilet by 25mm

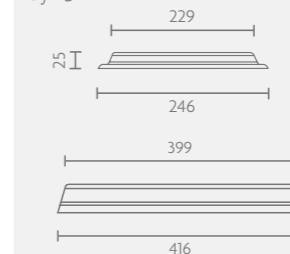

50mm Toilet Plinth Code: IP50
Raises the height of the toilet by 50mm

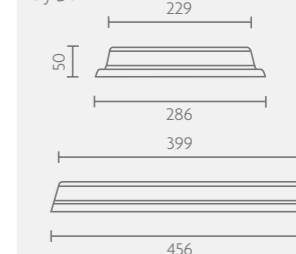

75mm Toilet Plinth Code: IP75
Raises the height of the toilet by 75mm

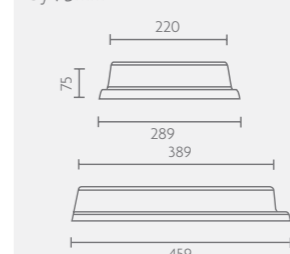

100mm Toilet Plinth Code: IP100
Raises the height of the toilet by 100mm

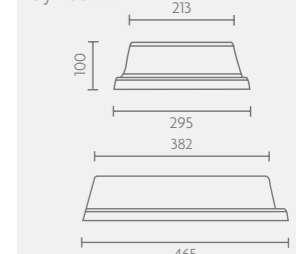

Accessories

Apres Body Dryer

Code: BODYDRYER

The Apres Body Dryer is a complete all-over body dryer.

Tested to rigorous safety standards, it fits neatly into most bathing and shower areas and helps make towels a thing of the past.

3 year warranty.

Technical Specification

- Height 2075mm
- Voltage: 220/240V
- Normal Output: 2.9kW
- Average Air outlet temperature: 21°C
- 2 speed on/off air switch
- ABS plastic construction
- Tested to EN60 335-2-23 1990
- Sound Level: 70dB



Impey Plastic Access Panels

The Plastic Access Panel is designed to fit into any wall and ceiling where access is required to stopcocks, pipes etc. Or simply use to fill unsightly holes, saving the need for expensive repairs. The high impact styrene plastic with U.V. stabilisers will not fade or corrode.



- Easy installation
- 3mm thick High Impact Styrene Plastic with U.V. Stabilizers
- White textured exposed surfaces, which allow for painting
- Available in 4 sizes:
 - 152 x 228 Code: AP1523
 - 203 x 203 Code: AP2020
 - 300 x 300 Code: AP3030
 - 355 x 355 Code: AP3535

Lifetime guarantee

Impey Showers Limited guarantees its range of branded showering products against faulty materials or manufacture for a Lifetime, provided that they have been installed and maintained in accordance with the manufacturer's instructions.

LIFETIME
GUARANTEE

The guarantee extends to non-electrical products in general use and excludes normal wear and tear. For products such as taps, shower valves, bathroom accessories, waterproofing and electrical products, the standard manufacturer's guarantee will apply. Where products included in the Lifetime guarantee are used for commercial use, such as hospitals, nursing homes or hotels, a 5 year guarantee will be applicable.

Parts that are defined as wearing parts, such as seals, seat pads etc, are subject to a 5 year guarantee.

If in our opinion the product has been modified, neglected, misused or is the subject of accidental damage the guarantee will not be applicable.

Impey Showers Limited has a policy of continuous improvement and therefore reserves the right to revise or amend the specification of any product without notice. In situations where a product has failed, subject to the terms of the guarantee, and a direct replacement is no longer available, Impey Showers Ltd will replace it with the nearest equivalent product.

The liability of Impey Showers Limited does not extend to consequential loss or damage arising from the defective product and is limited to the price of the original goods supplied by Impey Showers Limited.

The guarantee is in addition to your statutory rights.

Full terms and conditions available on our website
www.impeyshowers.com

Whilst every care has been taken to ensure that the information in this document was accurate at the time of printing, we reserve the right to change product specifications at any time without prior notice. The photographs reproduced in this publication are within the constraints of the printing process and are not to be used for matching purposes. All photographs are used for approximate representation only and may not show the actual products on offer. E&OE.

Level-Dec EasyFit, Maxi-Grip, Radiate, Mendip and Mantis are all trademarks of Impey Showers Limited.

impey

Impey Showers Limited, Conquest Business Park, Cad Road, Ilton, Somerset, TA19 9EA

Switchboard: 01460 256 080 Sales: 01460 256 090

Technical Helpline: 01460 258 682 Fax: 01460 259 800

www.impeyshowers.com Email: orders@impeyshowers.com



/Impeyshowers



@impeyshowers



ISO9001:2008



ISO14001:2004

