

ARMITAGE SHANKS MENA

IDEAL STANDARD GULF FZCO

Jebel Ali, Dubai
P.O. Box 261559
United Arab Emirates

Head Offices Dubai tel. +971 48042400

Sales Offices Athens tel. +30 210 6790800

Email: infogulf@armitageshanks-mena.com

IDEAL STANDARD INTERNATIONAL EGYPT

Regional Sales Office
117, El Thawra St.,
Heliopolis, Cairo
Egypt

Tel. +2 (02) 24145807

+2 (02) 24186321

+2 (02) 24186323

Fax.: +2 (02) 24186320

Email: infoafrica@armitageshanks-MENA.com

www.armitageshanks-MENA.com

*Armitage
Shanks*

*Armitage
Shanks*

splash*

Contour 21

Splash

The next generation washroom for the next generation



Introduction.

Armitage Shanks has been manufacturing school washrooms for over 100 years, ensuring the very best standards are met for children, no matter the stage of their educational journey.

Introducing the latest range of fun and interactive school washroom products

- Bright coloured seats and push plates to give interest and vibrancy
- Hybrid rimless technology for extra water hygiene and water saving
- Water saving wc's and taps
- Ergonomic design with smooth lines for safety and easy cleaning
- New 355mm wall hung pan
- Range covers ages 3 to 5 years, 5 to 7 years and 7 to 11 years
- Easy to use and safe taps, including push button, lever and sensor
- New trough for faster flow of children through washroom

Contents









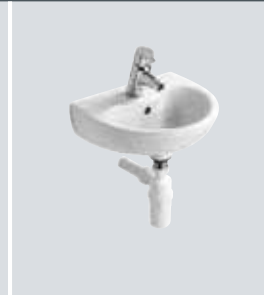
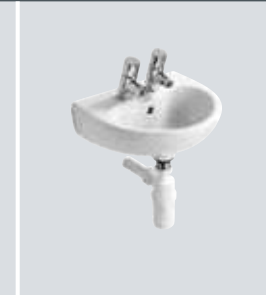

- 02 Product overview
- 04 Water Saving
- 06 Nursery (3-5 years of age)
- 10 Primary - Key stage 1 (5-7 years of age)
- 14 Junior - Key stage 2 (7-11 years of age)
- 18 Technical Specifications

“Being able to visit the washroom and feel safe and comfortable is crucial to a happy school life”

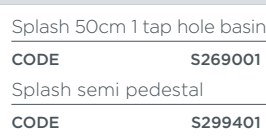
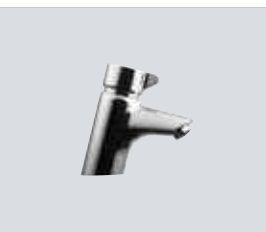
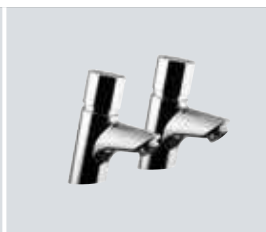
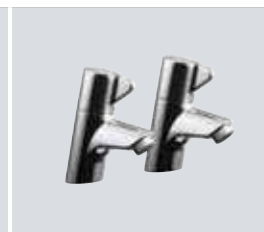
Mrs Taylor, teacher

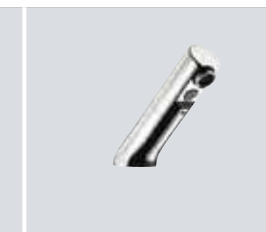

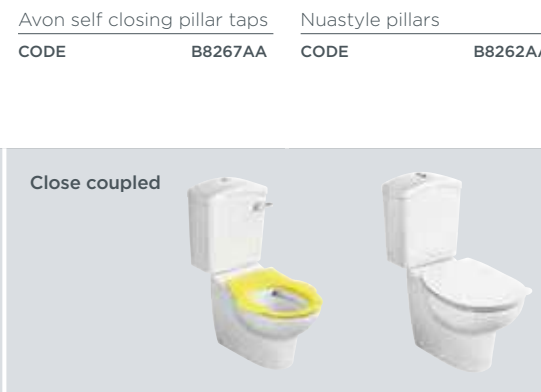
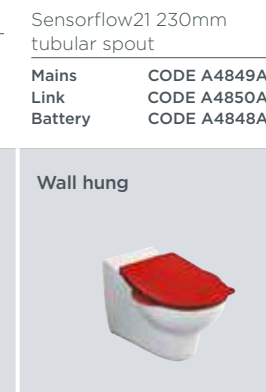
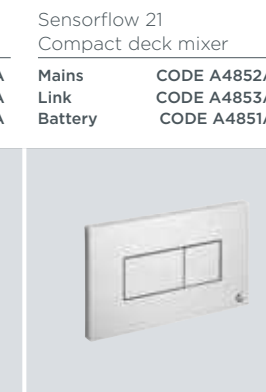
How to create your Splash washroom

					
Splash 50cm 1 tap hole basin CODE S269001	Splash 50cm two tap hole basin CODE S269101	Splash 40cm one taphole basin CODE S263501	Splash 40cm two tap hole basin CODE S263601	Broadway trough 120CM CODE S209801 180CM CODE S209901 240CM CODE S210501	
					
Splash semi pedestal CODE S299401					
					
Avon self closing mixer CODE B8263AA	Avon self closing pillar taps CODE B8267AA	Nuastyle pillars CODE B8262AA	Sensorflow21 230mm tubular spout Mains CODE A4849AA Link CODE A4850AA Battery CODE A4848AA	Sensorflow 21 Compact deck mixer Mains CODE A4852AA Link CODE A4853AA Battery CODE A4851AA	
					
Splash 355mm rimless back to wall pan CODE S312501	Splash 355mm rimless pan CODE S312501	Eco 4/2.6 litre dual flush lever cistern CODE S326001	Splash 355mm rimless wall hung WC CODE S31270	Karisma flush plate CODE E4465AA	TMV Thermostatic mixing valve CODE A5900AA
Splash 305mm rimless pan CODE S312201	Splash 305mm rimless pan CODE S312201	Eco 4/2.6 litre dual flush button cistern CODE S326101			

Why choose Splash?



1. Environment

Bright and engaging designs with vibrant WC seats and flush plates to encourage positive experiences within the school washroom.

2. Ergonomic

Every product has been designed for ease of use across a wide age range of children. Ergonomically designed WC seats with handles enable children to get on and off the toilet easily, whilst being comfortable to use. Basin design continues the aesthetic throughout the entire washroom.

3. Hygiene

The introduction of the 355mm wall hung pan gives yet another level of cleanliness to the washroom. The rimless pans ensure that this hygiene is carried through to the inside of the pan, as the lack of a rim ensures that Bacteria has nowhere to hide.

4. Safety

Innovative technologies ensure the safest environment for children. Including thermostatic taps and mixers which maintain a cool body to prevent scalding. Cover fastener, to prevent children from removing the cistern lid.

5. Water saving

Splash wc's are designed with the latest water saving technology, helping to protect the environment and save you money. The development of the Eco flush button and Eco flush lever, with their green water saving buttons, helps to educate children about good water usage behaviour.

Add to this a combination of Sensorflow taps, push button fittings and dual flush pushplates and you can ensure the most efficient use of water.

Water Saving technology

Almost 33% of the water used in schools comes out of washroom taps. Simply fitting a tap with a flow limiter will reduce this figure by a substantial 58%.



Water saving technology

- The Splash range can help to reduce your water bills by over 30%
- Splash wc's flush on as little as 4/2.6 litres
- Rimless technology helps to reduce the amount of water used for each flush
- The new Eco button and Eco flush lever can reduce the amount of water flushed by 35%, with a simple push of a fun green button
- Each cistern contains a sticker to help the children understand how to use the green buttons and ultimately save water
- We also know that water usage is greatly affected by user behaviour. When you buy Contour 21 Splash we provide educational material to teach children how they can reduce water usage, helping them learn good habits for later in life.

Dual flush cisterns can easily save water in school washrooms. Correct usage and maintenance are important to realise the water-saving benefits of this technology.

The Environment agency believes that most schools can easily reduce water consumption, and their water bills by 30%

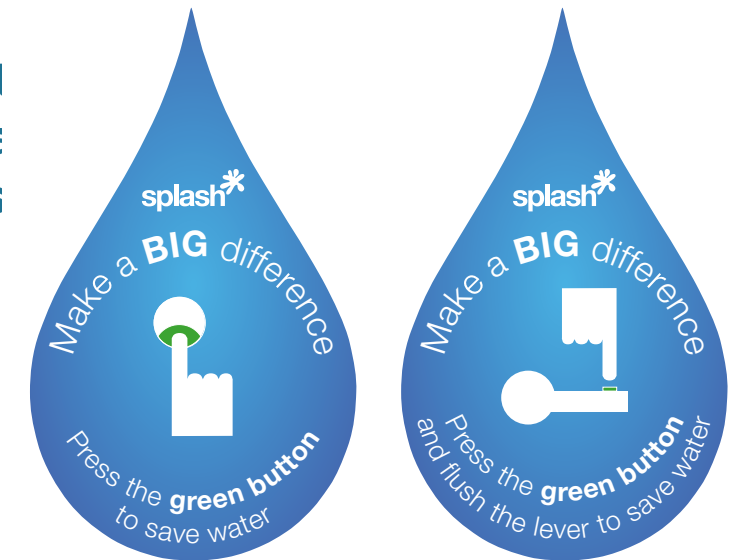

Nursery. Providing washrooms to improve confidence

Splash has been carefully designed to ensure that children have an inviting comfortable environment, making for an easy transition from home to public washroom.

“I really enjoy going to the toilet here at school, I like the colours and the green button which uses less water.”

Stevie, aged 5.





Specially designed for younger children, the 305 wc pan, 40cm basin and easy action taps, make this washroom the perfect choice for any nursery.



Key Stage 1. Building for tomorrow, today

When starting Key Stage 1, children will visit the toilet alone, possibly for the first time. With its bright colours and fun design, Splash makes this change easier.

“My school has great toilets. I used to be scared to go and would wait until I got home, but now I like it better at school!”

Lucy, aged 8.





Easy to use push button taps automatically turn off after a few seconds, avoiding unnecessary water wastage

“We’ve been learning about how water saving and helping the environment is really important at school. So I like how we can help with the new toilets and taps.”

Jonathan, aged 9



Key Stage 2. Simplistic facilities with an air of maturity

As children enter Key Stage 2 Splash offers larger basins and wc's. The range is flexible enough to offer more grown up facilities whilst keeping design continuity throughout the school washrooms





Junior. (7-11 years of age)

17

This Key Stage 2 washroom features the new wall hung pan designed for easy cleaning inside, outside and around the bowl. Adding a semi ped to the 50cm basin not only conceals the pipe work but adds a level of sophistication for the older child.

“The new school washrooms have made my life easier as they take less time to clean.”

Chrissie school cleaner

Technical specifications

Find the perfect solution for your school with detailed drawings and vital measurements to help you specify for your exact space.

06 Nursery (3-5 years of age)

10 Primary - Key stage 1 (5-7 years of age)

14 Junior - Key stage 2 (7-11 years of age)



Technical specifications.

Nursery, 3-5 years

1a.



Splash 40cm one tap hole basin
CODE S263501

1b.



Splash 40cm two tap hole basin
CODE S263601

2.

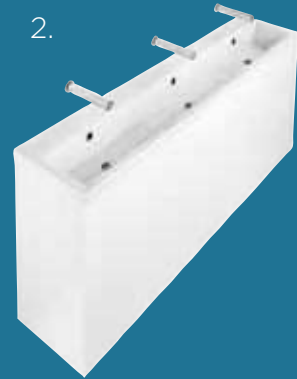

Broadway trough
120CM CODE S209801
180CM CODE S209901
240CM CODE S210501

3.



Nuastyle pillar taps
CODE B8262AA

4.

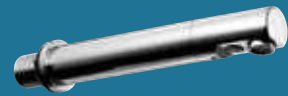

Sensorflow21 tubular spout 230mm projection
MAINS CODE A4849AA
LINK CODE A4850AA
BATTERY CODE A4848AA

5.



Splash 305mm close coupled WC
Rimless pan CODE S312201
Eco 4/2.6 litre dual flush lever cistern CODE S326001 (as shown)
Eco 4/2.6 litre dual flush button cistern CODE S326101

6.

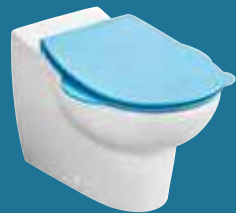

Splash 305mm Back to wall
Rimless pan (as shown) CODE S312201
For all seat covers and seat rings see page 26

7.



Karisma flush plate
Chrome (as shown) CODE E4465AA
Yellow CODE E446579
Red CODE E4465GQ
Blue CODE E446536

Nursery, 3-5 years

1a.

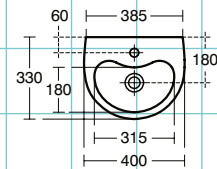

1b.

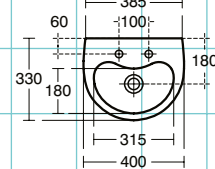

2.

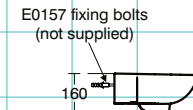
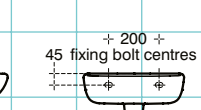
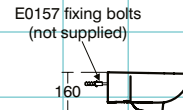
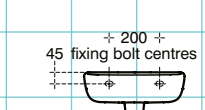
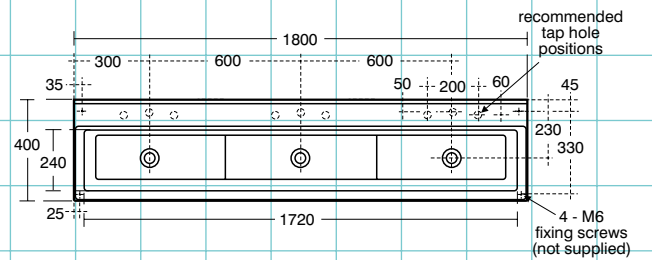

3.

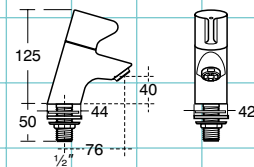

4.

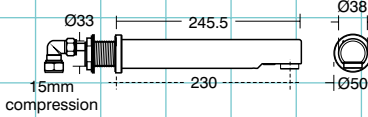

5.

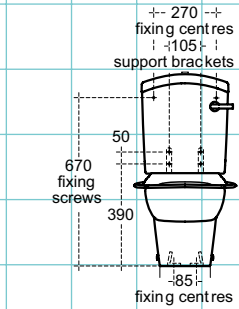
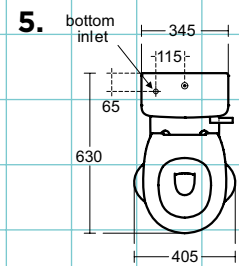

6.

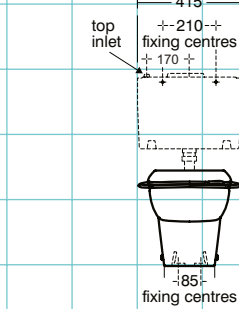
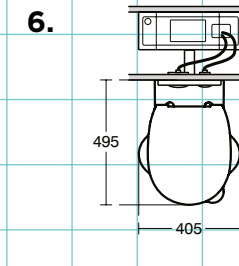

7.

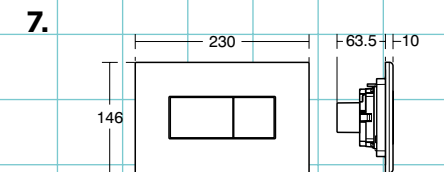

Technical specifications.

Key Stage 1, 5-7 years

1a.



Splash 40cm one taphole basin
CODE S263501

1b.



Splash 40cm two taphole basin
CODE S263601

2.



Avon self closing mixer
CODE B8263AA

3.



Avon self closing pillar taps
CODE B8267AA

4.



Splash 305mm close coupled WC
Rimless pan CODE S312201
Eco 4/2.6 litre dual flush lever cistern
CODE S326001 (as shown)
Eco 4/2.6 litre dual flush button cistern
CODE S326101

5.



Splash 305mm Back to wall
Rimless pan
For all seat covers and seat rings see page 26

6.



Karisma flush plate
Chrome CODE E4465AA
Yellow CODE E446579
Red CODE E4465GQ
Blue (as shown) CODE E446536

Key Stage 1. 5-7 years

1a.

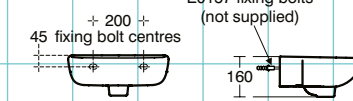
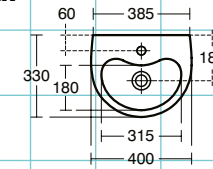

E0157 fixing bolts (not supplied)

1b.

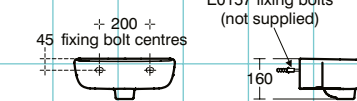
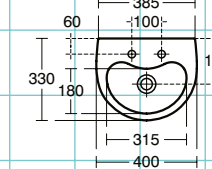

E0157 fixing bolts (not supplied)

2.

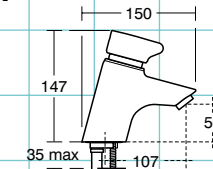

15mm compression

3.

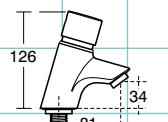

15mm compression

4.

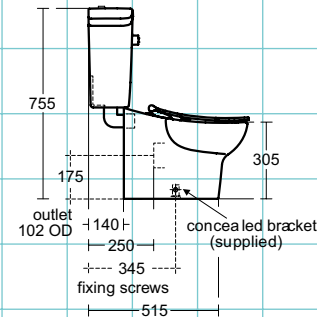
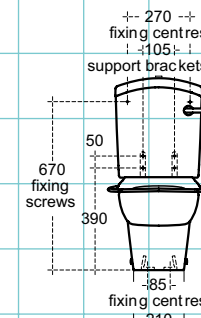
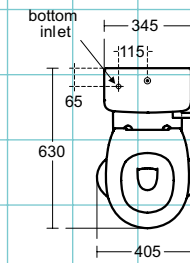

5.

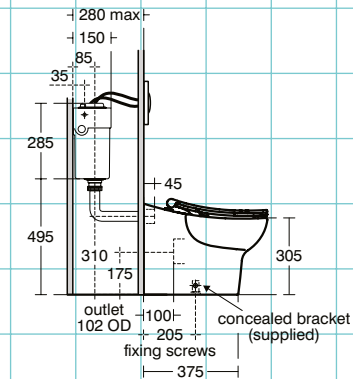
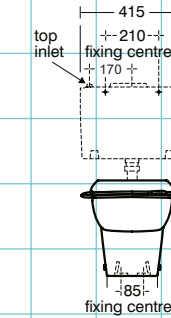
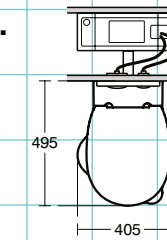

6.

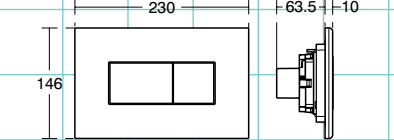

Technical specifications.

Key Stage 2, 7-11 years

1.



Splash semi pedestal
CODE S299401

2.



Splash 50cm one taphole
CODE S269001

3.



Splash 50cm two taphole
CODE S269101

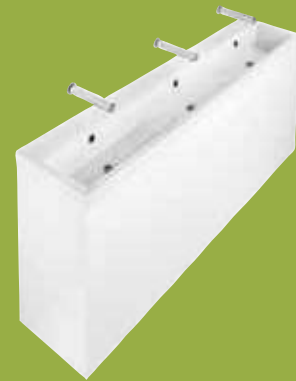

Broadway trough
120CM CODE S209901
180CM CODE S209801
240CM CODE S210501

5.



Sensorflow21 tubular spout 230mm projection
MAINS CODE A4849AA
LINK CODE A4850AA
BATTERY CODE A4848AA

6.



Sensorflow21 Compact deck mixer
MAINS CODE A4852AA
LINK CODE A4853AA
BATTERY CODE A4851AA

7.



Avon self closing mixer
CODE B8263AA

8.



Karisma flush plate
Chrome CODE E4465AA
Yellow (as shown) CODE E446579
Red CODE E4465GQ
Blue CODE E446536

Key Stage 2. 7-11 years

1.

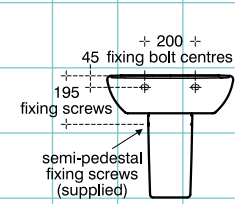
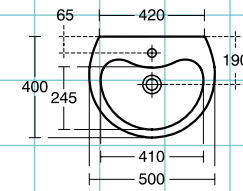

2. & 3.

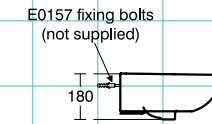
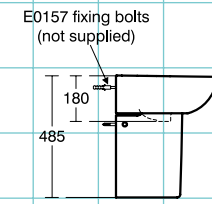
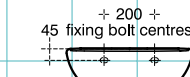
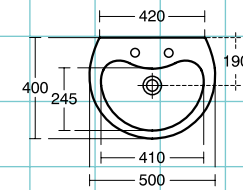

4.

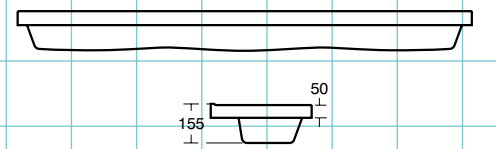
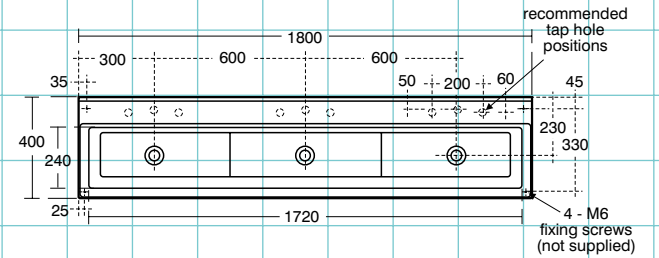

5.

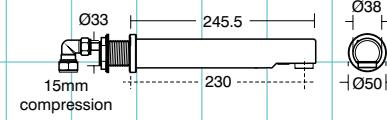

6.

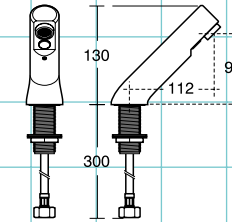

7.

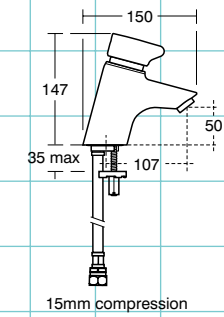

8.

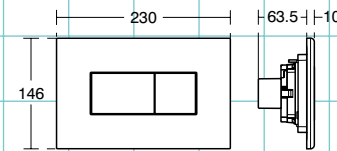

Technical specifications.

Key Stage 2, 7-11 years

1.



Splash 355mm wall hung rimless WC
CODE S312701

2.



Splash 355mm close coupled/BTW Pan
Rimless pan CODE S312501

ECO 4/2.6 Litre dual flush lever cistern
CODE S326001

ECO 4/2.6 Litre dual flush button cistern
CODE S326101

3.



Splash 355mm back to wall rimless pan
CODE S312501



Seats, seat covers and seat rings

Seat and cover for 355mm bowls

Yellow	S453679
Red	S4536GQ
Blue	S453636
White	S453601

Seat ring only for 355mm bowls

Yellow	S454579
Red	S4545GQ
Blue	S454536
White	S454501

Seat and cover for 305mm bowls

Yellow	S453379
Red	S4533GQ
Blue	S453336
White	S453301

Seat ring only for 305mm bowls

Yellow	S454279
Red	S4542GQ
Blue	S454236
White	S454201



Karisma flush plate

Blue	E446536
Yellow	E446579
Red	E4465GQ
Chrome	E4465AA

Key Stage 2. 7-11 years

1.

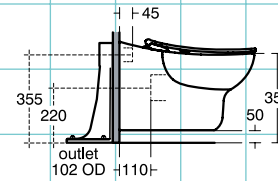
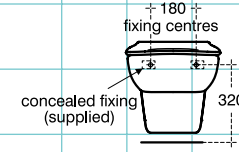
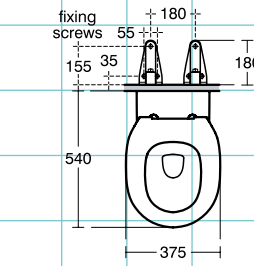

2.

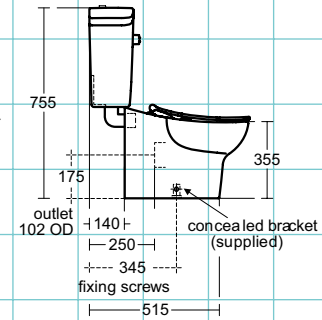
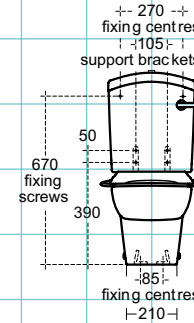
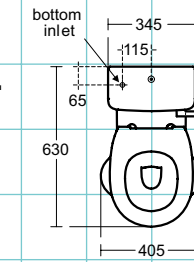

3.

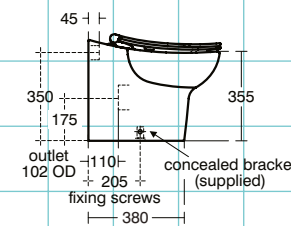
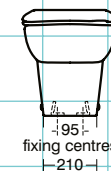



Guarantee

Lifetime

All ceramic products

5 years

on taps and mixers, toilet seats and cistern fittings

Our confidence in the quality and reliability of our product allows us to offer outstanding extended guarantees on all our products - where the product fails within 5/25 years/lifetime we offer a free replacement or replacement part (or nearest equivalent). So when your washroom and bathroom has been satisfactorily installed and is working well, please ensure you register your guarantee.

Liability is limited to individual products and the guarantee does not cover the consequential loss or damage or installation costs. This guarantee does not affect your statutory rights. Products must be installed, used and cared for in line with our fixing instructions and local water regulations, and room must be adequately ventilated.

Parts (eg. flushvalves) are guaranteed for five years and will be replaced if found to be faulty. The guarantee does not cover general wear and tear. Applies to UK and Republic of Ireland only.

Colours printed in this book are as near as possible to the manufactured range of Armitage Shanks quality bathrooms. For accurate comparisons of colours, see actual ware on display at Armitage Shanks retailers. Our policy is one of continuous improvement and we reserve the right to change specification and design at any time without notice.

All measurements are in millimetres and are approximate. Products can be subject to tolerances due to manufacturing processes.

technical helpline

0800 590311