

AQUAVISION®  
television evolved

# Contents:

Why choose Aquavision?	2
<b>OUR TELEVISIONS</b>	<b>4</b>
Essentials Range	5
Extended Range	7
Tailored Collection	15
Bang and Olufsen	16
Bespoke	17
Bespoke Quotation Form	18
Ultra	19
Echo	20
Aquavision Outdoor TV	21
Television Combinations	23
Compare LCD Features	24
<b>INSTALLATION SUPPORT</b>	<b>25</b>
Installing an Aquavision	26
Sauna/Steam Room Installation Details	30
Installing your Bang & Olufsen Board	31
Relay Interface Module	33
Using the Relay Interface Module	34
Viewing Angles	35
<b>TECHNICAL FEATURES</b>	<b>36</b>
Hotel Mode	37
Cloning Your TV Settings	39
Product Specification	40
ConnecTV Active Module	41
IR Board Connection Details	42
Legacy Product IR Codes	43
Installing your Control 4 IR Board	44
IP/RS232 Set Up Instructions	45
Satellite List Editing	47
<b>UPGRADES AND SPARE PARTS</b>	<b>48</b>
Upgrade Kits & Spares	49
Remote Controls	51
<b>CREDIT APPLICATION FORMS</b>	<b>53</b>
UK Credit Account Application	54
Non UK Credit Account Application	57



# Why Choose Aquavision?

Aquavision are the **Originators** of the waterproof, bathroom and in-wall television. Designing and building high performance televisions for harsh environments since 1997.

Aquavision's products are verified by the "**Made in Britain**" campaign, meaning our products are designed and manufactured in our own premises in the UK.

We offer the widest range of sizes, styles and features of any waterproof, bathroom or in-wall television manufacturer.

We developed our own exclusive, world leading technology in our **Connec-TV Active** range where the power, control and signal are all delivered through a single CAT6 cable. This is a world first!

We guarantee to support all our products and offer upgrade solutions up to **15 years!**  
We boast a "Fit and Forget" rule, assuring complete peace of mind.

All our LCDs provide full **178° x 178° viewing angles** to give you the best viewing experience.

All our LCDs incorporate **commercial grade panels** so they are guaranteed to last up to **10x longer** than conventional television panels.

In the UK, we offer a unique **2 year in-home warranty**.  
Our worldwide distributors work to ensure that we offer industry leading guarantees in all other countries.

We carry stocks of **ALL** parts for at least **5 years** after a product has ceased production.

Aquavision are **compatible with the world's leading home integration control systems** as well as being the **first specialist television to incorporate RS232 control**.

We are the **number one choice** in many of the world's most popular commercial hotels, countless independent boutique hotels and the majority of the world's best Home Network and Custom Installation integrators.

**Choose Aquavision. Choose Peace of Mind.**





# Our Televisions

Aquavision offer 2 ways of purchasing televisions.

- The Essentials Range

The Essentials Range is essentially a **one-box solution** of our most popular products enabling a simple, single code to assist in ordering.

- The Extended Range

Each Aquavision can be **individually customised** to your personal requirements

# Essentials Range

Based on the most popular Frameless Design with MirrorVision Glass. Available in sizes 16”- 42”.  
Includes:

- Frameless Mounting Kit Including Power Supply
- Frameless MirrorVision Glass
- Master and Waterproof Remote Controls
- Available with or without waterproof AVF-4 (Genesis) or AVF-3 (Nexus/Pinnacle) Ceiling Speakers
- Your chosen TV Component (Either Genesis, Nexus or Pinnacle)



## Genesis For when you need a simple, stand-alone television.

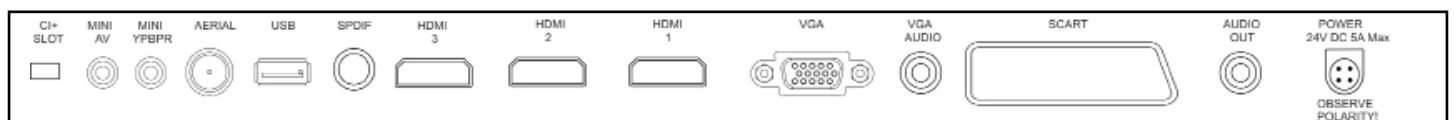

- AVF16L-CGMVE.....Complete 16” Genesis MV Glass
- AVF22L-CGMVE.....Complete 22” Genesis MV Glass
- AVF27L-CGMVE.....Complete 27” Genesis MV Glass
- AVF32L-CGMVE.....Complete 32” Genesis MV Glass
- AVF42L-CGMVE.....Complete 42” Genesis MV Glass

- AVF16L-CGMVSE.....Complete 16” Genesis MV Glass & Speakers
- AVF22L-CGMVSE.....Complete 22” Genesis MV Glass & Speakers
- AVF27L-CGMVSE.....Complete 27” Genesis MV Glass & Speakers
- AVF32L-CGMVSE.....Complete 32” Genesis MV Glass & Speakers
- AVF42L-CGMVSE.....Complete 40” Genesis MV Glass & Speakers





**Nexus** Our Nexus Essentials product is ideal for incorporating into a home automation system. With full discrete IR and IR RS232 control, DVB-T2 [Freeview HD] and DVB-S2 [Freesat HD] tuners.

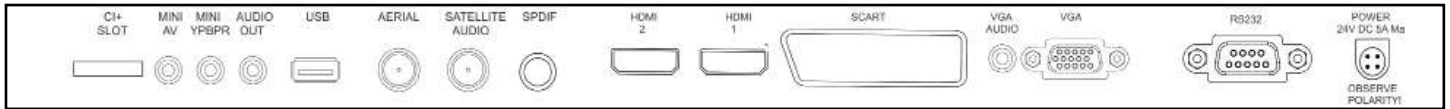

- AVF16L-CNMVE.....Complete 16” Nexus, MV Glass
- AVF22L-CNMVE.....Complete 22” Nexus, MV Glass
- AVF27L-CNMVE.....Complete 27” Nexus, MV Glass
- AVF32L-CNMVE.....Complete 32” Nexus, MV Glass
- AVF42L-CNMVE.....Complete 42” Nexus, MV Glass

- AVF16L-CNMVSE.....Complete 16” Nexus, MV Glass & Speakers
- AVF22L-CNMVSE.....Complete 22” Nexus, MV Glass & Speakers
- AVF27L-CNMVSE.....Complete 27” Nexus, MV Glass & Speakers
- AVF32L-CNMVSE.....Complete 32” Nexus, MV Glass & Speakers
- AVF42L-CNMVSE.....Complete 40” Nexus, MV Glass & Speakers

**Pinnacle Smart TV** Combining the latest Android 4.4.2 processor with inputs including HDMI, USB, Ethernet, RS232 and full IP control into a simple one-box solution.

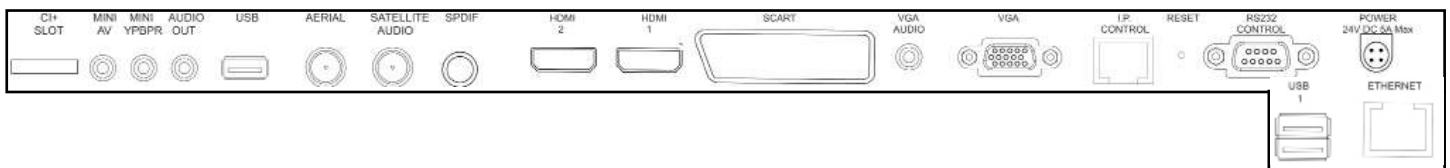

- AVF16L-CPMVE.....Complete 16” Pinnacle, MV Glass
- AVF22L-CPMVE.....Complete 22” Pinnacle, MV Glass
- AVF27L-CPMVE.....Complete 27” Pinnacle, MV Glass
- AVF32L-CPMVE.....Complete 32” Pinnacle, MV Glass
- AVF42L-CPMVE.....Complete 42” Pinnacle, MV Glass

- AVF16L-CPMVSE.....Complete 16” Pinnacle MV Glass & Speakers
- AVF22L-CPMVSE.....Complete 22” Pinnacle MV Glass & Speakers
- AVF27L-CPMVSE.....Complete 27” Pinnacle MV Glass & Speakers
- AVF32L-CPMVSE.....Complete 32” Pinnacle MV Glass & Speakers
- AVF42L-CPMVSE.....Complete 40” Pinnacle MV Glass & Speakers



# Extended Range

Finish + Glass colour + TV Component + Accessories = Aquavision

## 1 Choose your TV Size & Features

Genesis | Nexus | Nexus+ | Pinnacle | Connec-TV | Connec-TV Active | Elite 4K

## 2 Choose your Fixing Style



Frameless



Classic



Silhouette

## 3 Choose your Glass



Black



Polar White



MirrorVision



MirrorVision+

## 4 Accessories

Aquavision offer a range of accessories to enhance customer experience.



# 1 Choose your TV Size & Features

**Genesis** The evolution of our original design of in-wall waterproof televisions; Genesis is the first choice for stand alone television projects. With 3 HDMI Inputs, Component/Composite Inputs, Digital FreeView Tuner, built-in Amplifier, and our unique 178° Viewing Angles to provide even more possibilities.

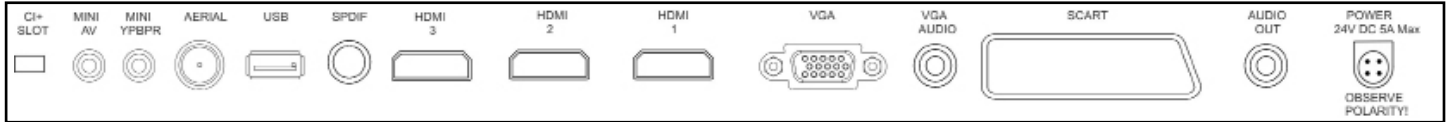

- AVF16L-GLCD.....16" Genesis LED LCD Component
- AVF22L-GLCD.....22" Genesis LED LCD Component
- AVF27L-GLCD.....27" Genesis LED LCD Component
- AVF32L-GLCD.....32" Genesis LED LCD Component
- AVF42L-GLCD.....42" Genesis LED LCD Component

**Nexus** The first choice for system integrators. Two HDMI Inputs, Component/Composite Inputs, built-in Amplifier, Discrete IR and RS232 Control, FreeView HD Tuner, FreeSat HD Receiver. As well as our unique 178° Viewing Angles.

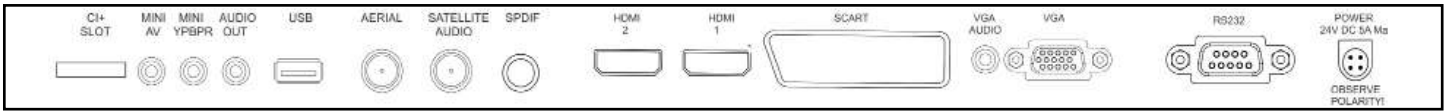

- AVF16L-NLCD.....16" Nexus LED LCD Component
- AVF22L-NLCD.....22" Nexus LED LCD Component
- AVF27L-NLCD.....27" Nexus LED LCD Component
- AVF32L-NLCD.....32" Nexus LED LCD Component
- AVF42L-NLCD.....42" Nexus LED LCD Component

**Nexus+** All the features of Nexus, but with the added benefit of full IP Control.

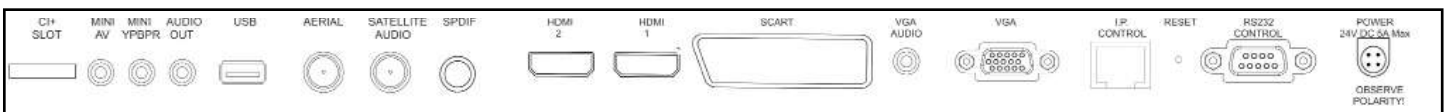

- AVF16L-NPLCD.....16" Nexus LED LCD Component
- AVF22L-NPLCD.....22" Nexus LED LCD Component
- AVF27L-NPLCD.....27" Nexus LED LCD Component
- AVF32L-NPLCD.....32" Nexus LED LCD Component
- AVF42L-NPLCD.....42" Nexus LED LCD Component



# Pinnacle Smart TV

The ultimate in in-wall waterproof televisions. These intelligent Smart TVs allow you to not only watch your favorite shows, but also allow you to access the web from Amazon to Wikipedia. You can also load in android based Apps. There are plenty of Inputs including HDMI, USB, Ethernet, RS232 and IP Control and the conventional Component and Composite Inputs.

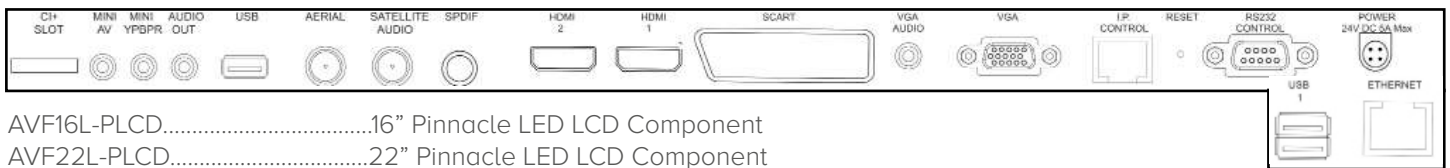

- AVF16L-PLCD.....16” Pinnacle LED LCD Component
- AVF22L-PLCD.....22” Pinnacle LED LCD Component
- AVF27L-PLCD.....27” Pinnacle LED LCD Component
- AVF32L-PLCD.....32” Pinnacle LED LCD Component
- AVF42L-PLCD.....42” Pinnacle LED LCD Component

# Connec-TV/Connec-TV Active

Connec-TV uses the full capability of HDBaseT and our own patent pending technology. These TVs are the perfect solution for integrated distribution systems and incorporate IR Control.

Connec-TV Active is the same as Connec-TV with added power (POH) sent down one CAT5e/6 cable in our 22”/27” models.

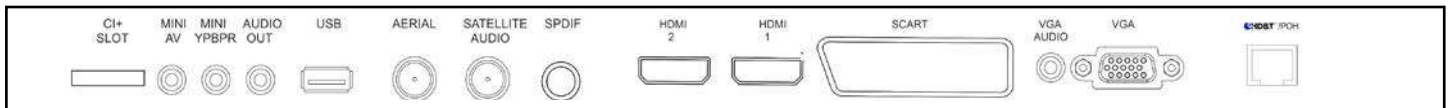

- AVF16L-HLCD.....16” Connec-TV LED LCD Component
- AVF22L-HLCD.....22” Connec-TV LED LCD Component
- AVF27L-HLCD.....27” Connec-TV LED LCD Component
- AVF32L-HLCD.....32” Connec-TV LED LCD Component
- AVF42L-HLCD.....42” Connec-TV LED LCD Component

- AVF22L-ALCD.....22” Connec-TV Active LED LCD Component
- AVF27L-ALCD.....27” Connec-TV Active LED LCD Component
- AVFCA-TX.....Connec-TV Active Transmit Module & PSU
- AVFCA-RACK.....1U Rack Mount Tray for TX Module

# Elite Ultra 4K

Astonish yourself with the most intensely detailed visual experience from the Aquavision Elite 4K televisions. Four times the resolution of Full HD means you’ll see every stunning image on an entirely new scale. See a picture that’s more lifelike than ever before. With HDMI 2.2, H265, Discrete IR, RS232 and IP Control as standard.

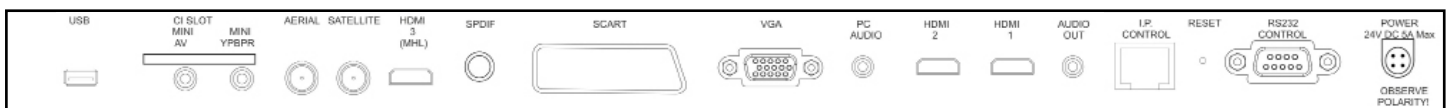

- AVF55L-4KLCD.....55” Elite 4K LED LCD Component
- AVF65L-4KLCD.....65” Elite 4K LED LCD Component
- AVF85L-4KLCD.....85” Elite 4K LED LCD Component



# 2 Choose your Fixing Style

**Frameless** This is our most popular finish. It utilises a slim [under 2"] in-wall back box. Waterproof to IP66.

Frameless Fixing Kit - Supplied as standard with Power Supply

AVF16L-4FK.....	16" Frameless Fixing Kit Inc PSU
AVF22L-4FK.....	22" Frameless Fixing Kit Inc PSU
AVF27L-4FK.....	27" Frameless Fixing Kit Inc PSU
AVF32L-4FK.....	32" Frameless Fixing Kit Inc PSU.
AVF42L-4FK.....	42" Frameless Fixing Kit Inc PSU
AVF55L-4FK.....	55" Frameless Fixing Kit Inc PSU
AVF65L-4FK.....	65" Frameless Fixing Kit Inc PSU
AVF85L-4FK.....	85" Frameless Fixing Kit Inc PSU



**Classic** This mount protrudes just 1.2mm from the wall. It can be installed with or without a back box.

AVF16L-4BBA.....	16" Classic Bezel Install Pack Inc PSU
AVF22L-4BBA.....	22" Classic Bezel Install Pack Inc PSU
AVF27L-4BBA.....	27" Classic Bezel Install Pack Inc PSU
AVF32L-4BBA.....	32" Classic Bezel Install Pack Inc PSU
AVF42L-4BBA.....	42" Classic Bezel Install Pack Inc PSU



**Silhouette** With it's ultra thin profile [under 2"] Aquavision's only 'on-wall' screen can be used where an in-wall solution is not possible or where you would prefer not to see a conventional television on a wall bracket.

AVF22L-4SBB.....	22" Surface Mount Install Pack Inc PSU
AVF27L-4SBB.....	27" Surface Mount Install Pack Inc PSU
AVF32L-4SBB.....	32" Surface Mount Install Pack Inc PSU
AVF42L-4SBB.....	42" Surface Mount Install Pack Inc PSU



# 3 Choose your Glass

## Frameless Glass

16"	AVG16L-4FMV.....	16" MirrorVision Glass Frameless
22"	AVG22L-4FMV.....	22" MirrorVision Glass - Frameless
	AVG22L-4FB.....	22" Black Glass - Frameless
	AVG22L-4FPW.....	22" Polar White Glass - Frameless
	AVG22L-4FMVPL.....	22" MirrorVision+ Glass - Frameless
27"	AVG27L-4FMV.....	27" MirrorVision Glass - Frameless
	AVG27L-4FBL.....	27" Black Glass - Frameless
	AVG27L-4FPW.....	27" Polar White Glass - Frameless
	AVG27L-4FMVPL.....	27" MirrorVision+ Glass - Frameless
32"	AVG32L-4FMV.....	32" MirrorVision Glass - Frameless
	AVG32L-4FBL.....	32" Black Glass - Frameless
	AVG32L-4FPW.....	32" Polar White - Frameless
	AVG32L-4FMVPL.....	32" MirrorVision+ Glass - Frameless
42"	AVG42L-4FMV.....	42" MirrorVision Glass - Frameless
	AVG42L-4FBL.....	42" Black Glass - Frameless
	AVG42L-4FPW.....	42" Polar White Glass - Frameless
	AVG42L-4FMVPL.....	42" MirrorVision+ Glass - Frameless
55"	AVG55L-4FMVPL.....	55" MirrorVision+ Glass - Frameless
	AVG55L-4FBL.....	55" Black Glass - Frameless
65"	AVG65L-4FMVPL.....	65" MirrorVision Glass - Frameless
	AVG65L-4FBL.....	65" Black Glass - Frameless
85"	AVG85L-4FMVPL.....	85" MirrorVision Glass - Frameless
	AVG85L-4FBL.....	85" Black Glass - Frameless



## Classic/Silhouette Glass

16"	AVG16L-4MV.....	16" MirrorVision Glass - Classic/Silhouette
22"	AVG22L-4MV.....	22" MirrorVision Glass - Classic/Silhouette
	AVG22L-4BL.....	22" Black Glass - Classic/Silhouette
	AVG22L-4PW.....	22" Polar White Glass - Classic/Silhouette
	AVG22L-4MVPL.....	22" MirrorVision+ Glass - Classic/Silhouette
27"	AVG27L-4MV.....	27" MirrorVision Glass - Classic/Silhouette
	AVG27L-4BL.....	27" Black Glass - Classic/Silhouette
	AVG27L-4PW.....	27" Polar White Glass - Classic/Silhouette
	AVG27L-4MVPL.....	27" MirrorVision+ Glass - Classic/Silhouette
32"	AVG32L-4MV.....	32" MirrorVision Glass - Classic/Silhouette
	AVG32L-4BL.....	32" Black Glass - Classic/Silhouette
	AVG32L-4PW.....	32" Polar White Glass - Classic/Silhouette
	AVG32L-4MVPL.....	32" MirrorVision+ Glass - Classic/Silhouette
42"	AVG42L-4MV.....	42" MirrorVision Glass - Classic/Silhouette
	AVG42L-4BL.....	42" Black Glass - Classic/Silhouette
	AVG42L-4PW.....	42" Polar White Glass - Classic/Silhouette
	AVG42L-4MVPL.....	42" MirrorVision+ Glass - Classic/Silhouette
55"	AVG55L-4MV.....	55" MirrorVision Glass - Silhouette
	AVG55L-4BL.....	55" Black Glass - Silhouette
65"	AVG65 L-4MV.....	65" MirrorVision Glass - Silhouette
	AVG65 L-4BL.....	65" Black Glass - Silhouette
85"	AVG85L-4MV.....	85" MirrorVision Glass - Silhouette
	AVG85L-4BL.....	85" Black Glass - Silhouette



# 4 Accessories

## Sky Kit

This allows connection to a remote Sky Box. Content from Sky to be viewed on the Aquavision and the Sky Box to be controlled remotely. Note this feature is included with all UK supplied televisions except the Genesis range where it is an optional extra and the Connect TV Active.

AVF-4SKYA.....Sky Infra Red Remote Control Kit



## Remote Switch Panel

The Remote Switch Panel offers a waterproof, wall-mounted solution for controlling the main television functions. It can be conveniently located adjacent to a bath, shower or basin. No need to replace any batteries and there is also no remote control to lose. Ideal for hotels/guest houses.

AVF-5RSP.....Remote Switch Panel



## Relay Interface

A handy little unit that provides two potential free (DPDT) contacts that are activated when the television is powered up. Ideal for switching external audio feeds, etc. or activating LED lights around the television or even a mirror.

AVF-5RLYF.....Relay Interface Module 2 pole

AVF-5RLYF4P.....Relay Interface Module 4 pole



## IR Link Kit

The IR Link Kit allows remote control of an external device such as a Blu-Ray player or set top box through the Aquavision's infrared input, with the signal being carried via the HDMI signal cable. The IR Blaster relays the Infrared signals to a DVD player, set top box or any other control device situated up to 1.5m away.

AVF-IRHDMI.....Infrared Link

AVF-IRBLAST.....Infrared Blaster

AVF-IRCON.....IR in/out Kit for ConnectTV



## Bang & Olufsen

AVF-BOBOARD.....Bang & Olufsen control board





## Glass Suction Cup

An absolute necessity for removing glass from Mark 1-3, Series 4 and CLASSIC range of products.

- Durable high impact nylon body
- Quick release handle
- Diameter - 115mm (4 1/2")



AVF-SCUP.....Suction Cup Tool for Removing Glass

## Power Supplies

AVPSU5.....PSU 12V 5A  
 AVF-PSU6.....PSU for Series 4 10"-26"  
 AVF-PSU24V3A.....PSU for Series 5 22"-42"  
 AVF-PSU24V6A.....PSU for Series 4 [32-40"] Series 5 [55"]  
 AVF-PSU24V9.2A.....PSU for Series 5 65"



## Remote Controls

AVF-MRC5.....Series 5 Master Remote Control  
 AVWRC-5.....Series 5 Waterproof Remote Control



## Optional In-Wall Back Box for Classic Bezels

The back box is recommended when installing your Classic Aquavision in dusty or damp walls.

AVF16L-4GBB.....16" Classic Bezel Wall Back Box  
 AVF22L-4GBB.....22" Classic Bezel Wall Back Box  
 AVF27L-4GBB.....27" Classic Bezel Wall Back Box  
 AVF32L-4GBB.....32" Classic Bezel Wall Back Box  
 AVF42L-4GBB.....42" Classic Bezel Wall Back Box



## Speakers

AVF-1SPEAKERS.....Pair Surface Mount Waterproof Speakers & Cable - HQ  
 AVF-2SPEAKERS.....Pair Surface Mount Waterproof Speakers & Cable - Std  
 AVF-3SPEAKERS.....Pair Ceiling Waterproof Speakers & Cable - HQ  
 AVF-4SPEAKERS.....Pair Ceiling Waterproof Speakers & Cable - Std  
 AVF-5SPEAKERS.....Single Stereo Ceiling Waterproof Speaker & Cable



# Tailored Collection

Our new “Tailored Collection” - designed to simplify and enhance your installation.

An “off-the-shelf” range of designer mirrors and housings. Designed to simplify the process of supplying a mirror without the need for bespoke design and waiting time.

Choose your Genesis, Nexus or Pinnacle TV separately to add to the mirror.

Available in 3 sizes and either portrait or landscape. Comes complete with power supply. Speakers are not included but will be required.

AVG32-16PMVPL.....550 x 833 (21 5/8 x 32 3/4) Glass for 16" Portrait MirrorVision+  
 AVG32-16LMVPL.....833 x 550 (32 3/4 x 21 5/8) Glass for 16" Landscape MirrorVision+  
 AVG32-22LMVPL.....834 x 550 (32 3/4 x 21 5/8) Glass for 22" Landscape MirrorVision+

AVG42-16PMVPL.....670 x 1028 (40 1/2 x 326 3/8) Glass for 16" Portrait MirrorVision+  
 AVG42-22PMVPL.....671 x 1028 (40 1/2 x 326 3/8) Glass for 22" Portrait MirrorVision+

AVG42-16LMVPL.....1027 x 671 (326 3/8 x 40 1/2) Glass for 16" Landscape MirrorVision+  
 AVG42-22LMVPL.....1028 x 671 (326 3/8 x 40 1/2) Glass for 22" Landscape MirrorVision+

AVG55-16PMVPL.....815 x 1300 (32 1/8" x 51 1/4") Glass for 16" Portrait MirrorVision+  
 AVG55-22PMVPL.....815 x 1300 (32 1/8" x 51 1/4") Glass for 22" Portrait MirrorVision+

AVG55-16LMVPL.....1300 x 815 ( 51 1/4" x 32 1/8") Glass for 16" Landscape MirrorVision+  
 AVG55-22LMVPL.....1300 x 815 ( 51 1/4" x 32 1/8") Glass for 22" Landscape MirrorVision+

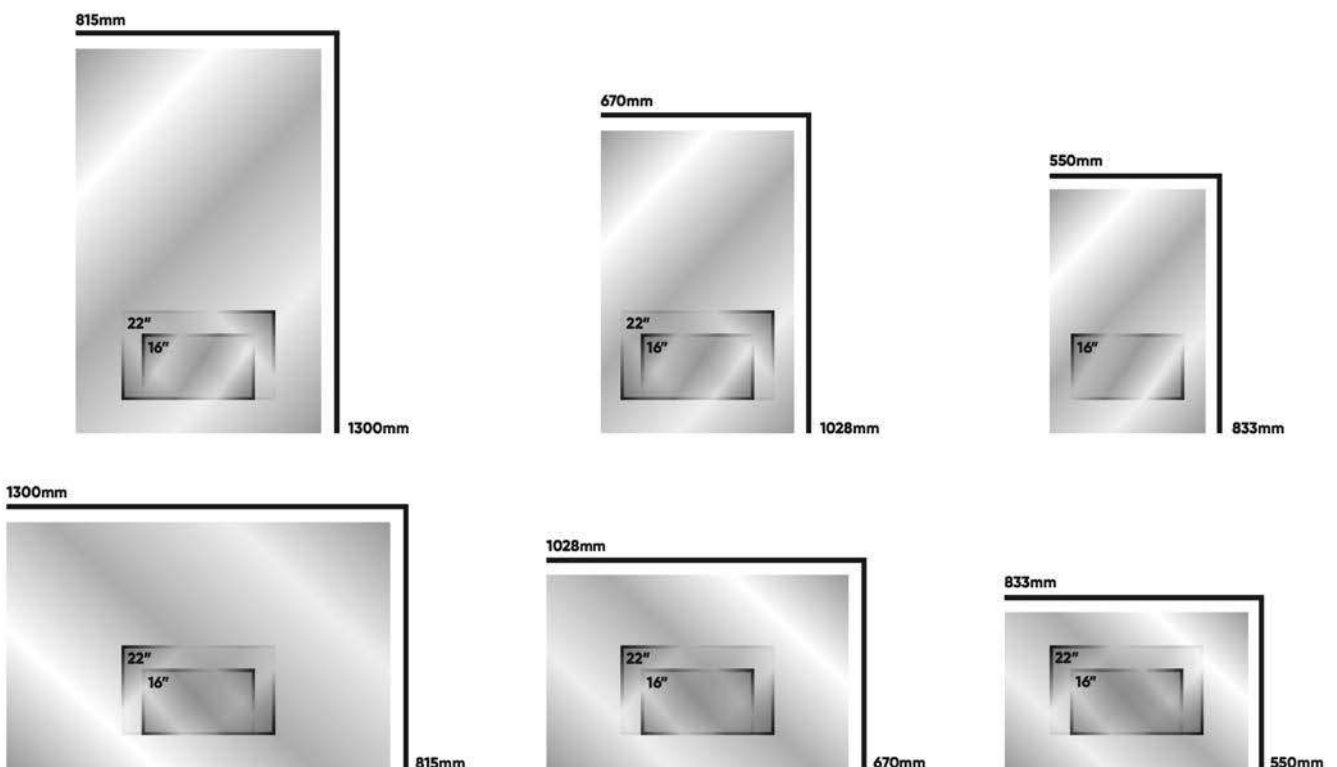

## BANG & OLUFSEN

Control your Aquavision via your BANG & OLUFSEN remote control and seamlessly integrate your BeoSystem4 controller.

In conjunction with BANG & OLUFSEN, we have developed a simple to install upgrade kit that will allow perfect, seamless integration of these iconic products.

Since BANG & OLUFSEN only make televisions from 40" upwards, we can now offer a viable alternative, whilst maintaining the customer experience of using the BANG & OLUFSEN remote control and the BEOSystem4 controller.



# Bespoke

Aquavision are able to offer complete bespoke solutions for that perfect TV mirror. In addition to MirrorVision+ glass, Aquavision can tailor the glass design, print colours, patterns, and company logos on the surface. It is not possible to view a television through a full-chromed mirror therefore Aquavision offer MirrorVision+, a perfect mirror with absolutely no visible signs of a screen when the television is off, but displaying a clear, bright image when the television is switched on.



For the customer looking to create their own mirror solution, we offer chassis mounts for all sizes of our televisions up to 85", so you can use your Aquavision television with your own "mirror" style glass.

## Chassis Mount Kits

- AVF16L-4CMK.....16" Chassis Mount Kit
- AVF22L-4CMK.....22" Chassis Mount Kit
- AVF27L-4CMK.....27" Chassis Mount bezel
- AVF32L-4CMK.....32" Chassis Mount Bezel
- AVF42L-4CMK.....42" Chassis Mount Bezel
- AVF55L-4CMK.....55" Chassis Mount Bezel
- AVF65L-4CMK.....65" Chassis Mount Bezel



## "L" Brackets & Magnets

- AVF-BESPOKE-LBRKT.....Bespoke Glass L Bracket Assembly
- AVF-BESPOKE-LBRKTS.....Bespoke Glass L Bracket Assembly - Small
- AVF-BESPOKE-MAG.....Bespoke Glass Magnet & Attractor Kit

## Adhesive

- AVF-BESPOKE-ADH.....Bespoke Glass Adhesive Kit



# Bespoke Quotation Form

To be able to give an accurate price, we will need the following information:		
A	Mirror Height	
B	Mirror Width	
C	Distance BOTTOM of TV to BOTTOM of mirror, or Central	
D	Distance LEFT side of TV window to LEFT side of mirror, or Central	
E	TV Screen size 16", 22", 27", 32", 42", 55", 65", 85" or leave BLANK for matching mirrors. [55", 65", 85" are Elite 4K only]	
TV Model	Genesis, Nexus, Pinnacle, ConneCTV/ConneCTV Active, Elite 4K.	
Glass Type	MirrorVision+ <sup>®</sup> or painted to RAL No.	
Dimensions	Please indicate unit of measurement	INCHES    CM    MM

Accessories		
AVF-5SPEAKERS	Stereo Ceiling speaker	
AVF-4SPEAKERS	Ceiling speaker	
AVF-3SPEAKERS	Ceiling speaker	
AVF-2SPEAKERS	Surface speaker	
AVF-1SPEAKERS	Surface speaker	
AVF-5RSP	Remote Switch Panel	
AVF-4SKYA	Sky Remote Eye Kit	
AVF-IRBLAST	Infrared Blaster	
AVF-SRLYF	Relay Interface Module	

Completed by: \_\_\_\_\_  
 Company: \_\_\_\_\_  
 Date: \_\_\_\_\_  
 Phone No: \_\_\_\_\_  
 Email: \_\_\_\_\_  
 Signed: \_\_\_\_\_

#### Notes:

- ◆ Aquavision's MirrorVision+ is the standard Mirror glass supplied
- ◆ Dimensions C and D are not required for initial quotation
- ◆ Aquavision only supply mirrors or custom glass for installation with Aquavision televisions
- ◆ Glass is generally ready for collection 6 weeks from confirmed order
- ◆ Mounting brackets may be suggested but it's the customer's responsibility to ensure these, and any fixings, are correct for the job
- ◆ Maximum size 2400mm x 1500mm or 94" x 60"
- ◆ Glass is 6mm [1/4"] thick

Any special requirements [holes for cables, lights, taps, Bevels etc]:

#### Aquavision use only.

Quote Reference \_\_\_\_\_ Drawing Reference 4009-\_\_\_\_\_ REV \_\_\_\_\_ Issued for Manufacturer \_\_\_\_/\_\_\_\_/\_\_\_\_  
 Expected delivery \_\_\_\_/\_\_\_\_/\_\_\_\_ Account Reference \_\_\_\_\_ PO# \_\_\_\_\_ SO# \_\_\_\_\_ Delivered \_\_\_\_/\_\_\_\_/\_\_\_\_

Please fill this in and email to your  
nearest Aquavision dealer

Find your nearest dealer at [www.aquavision.tv](http://www.aquavision.tv)



# Ultra

Ultra-thin LCD modules that can be incorporated into furniture and mirror designs. An incredible 26mm profile opens up endless possibilities. Customers can use their own glass design or incorporate it into Aquavision's Bespoke range. Available in 22" and 27" screen sizes.



AVF22L-GLCDUL.....22" Genesis LED LCD Slim Line Component  
AVF22L-NLCDUL.....22" Nexus LED LCD Slim Line Component  
AVF22L-PLCDUL.....22" Pinnacle LED LCD Slim Line Component

AVF27L-GLCDUL.....27" Genesis LED LCD Slim Line Component  
AVF27L-NLCDUL.....27" Nexus LED LCD Slim Line Component  
AVF27L-PLCDUL.....27" Pinnacle LED LCD Slim Line Component



The Echo Bluetooth Audio System allows you to stream music directly from your smartphone or tablet.

Echo is the perfect addition to complete any bathroom or kitchen installation. The first choice for a high quality, simple to use Bluetooth audio system, bringing any space in the home to life.

## Specifications

- Flush or surface mounted in a standard 25mm 2 gang enclosure
- Unit is always “ON” so no switch required
- Up to 8 units can be paired at any time
- 8 different Bluetooth names enabling multiple units to be used
- Auto pairing in order of priority
- Bluetooth V3 (supporting A2DP codecs, MPEG AAC ATRAC APTX)
- 20W RMS per channel 4-8 Ohms
- Class 2 Bluetooth with operating distance of 33ft
- Digital Class D amplifier design giving high efficiency with minimal heat

## Amplifier Module

AVF-ECAMP.....Echo Amp Component inc 12V PSU

## Amplifier Module & Speakers (AVF-4SPEAKERS)

AVF-ECAMPSP.....Echo Amp Component inc 12V PSU & Speakers

## Showroom Display

AVF-ECAMPPS.....Echo Showroom Display Box - Incl working Echo speakers



# Horizon Outdoor TV

**Horizon** is available in 32", 55" and 65". It has been exquisitely designed, and packed with features. This new range is guaranteed to enhance your swimming pool, patio, garden, boat and all other outdoor areas whether for residential, commercial, hospitality projects to keep your guests and clients entertained.

Fully IP65 rated to provide the ultimate protection against water, dust, moisture and indeed insects, Aquavision have designed a product range suitable for this harsh.

Offering high brightness of 1500 cd/m<sup>2</sup>, your Aquavision outdoor television provides a high quality, high-brightness, anti-reflective HD LED. Supplied as standard with a wide range of inputs including HDMI, VGA, Component, RGB, CI, and Scart, and with a RS232 and discrete IR control, this product is fully compatible with all leading control systems.





SPECIFICATION				FEATURES			
Panel Size	32"	55"	65"	Full Function Remote Control	yes		
Aspect	16:9	16:9	16:9	Teletext Page	yes		
Resolution	1366 x 768	1920 x 1080	1920 x 1080	Sleep Timer	yes		
Contrast	3000:1	3000:1	3000:1	Picture Freeze	yes		
Viewing angle	H:170°, V:160°	H:170°, V:160°	H:170°, V:160°	Channel Swap	yes		
				Tempered safety glass	yes		
Active area	698 x 392	1210 x 680	1428 x 803	Channel edit	yes		
Brightness	1500 cd/m2	1500 cd/m2	1500 cd/m2	Auto fan system on /off	yes		
PICTURE				CONNECTORS			
Comb Filter			3D	AV Input	yes		
De-interlace Scan/Progressive Scan			yes	VGA in	yes		
User Selectable Picture Control			yes	HDMI	yes		
Tint, colour, brightness, contrast, sharpness control			yes	Tuner	DVB-C/T2/S2. Pal I, B/G,D/K		
SOUND				Scart	yes		
Stereo			yes	CI slot	yes		
Tone Control (Bass/Treble/Balance) User Selectable Sound Control			yes	USB2.0	yes		
				PC Audio in	yes		
Built-in speakers			yes	Audio Out	yes		
ACCESSORIES				RS232 input	yes		
Master Remote control			yes	Coaxial	yes		
Waterproof Remote control			yes	Y,Pb,Pr.	yes		
POWER SUPPLY				DIMENSIONS	32"	55"	65"
Power Supply	AC 100-240V			Dimension (L x H x D)	798 x 522 x 100mm	1355 x 840 x 100mm	1550 x 860 x 100mm
Power Consumption	220W	300W	500W	Nett Weight	25kg	55Kg	70Kg
				VESA Fixings	600 x 400mm		



# Television Combinations

Style Size	Frameless	Classic	Silhouette	Tailored	Ultra	Bespoke
16"	Genesis Nexus Pinnacle ConnectTV ConnectTV Active	Genesis Nexus Pinnacle ConnectTV ConnectTV Active	Genesis Nexus Pinnacle ConnectTV ConnectTV Active	Genesis Nexus Pinnacle ConnectTV ConnectTV Active	Genesis Nexus Pinnacle ConnectTV ConnectTV Active	Genesis Nexus Pinnacle ConnectTV ConnectTV Active
22"	Genesis Nexus Pinnacle ConnectTV ConnectTV Active	Genesis Nexus Pinnacle ConnectTV ConnectTV Active	Genesis Nexus Pinnacle ConnectTV ConnectTV Active	Genesis Nexus Pinnacle ConnectTV ConnectTV Active	Genesis Nexus Pinnacle ConnectTV ConnectTV Active	Genesis Nexus Pinnacle ConnectTV ConnectTV Active
27"	Genesis Nexus Pinnacle ConnectTV ConnectTV Active	Genesis Nexus Pinnacle ConnectTV ConnectTV Active	Genesis Nexus Pinnacle ConnectTV ConnectTV Active		Genesis Nexus Pinnacle ConnectTV ConnectTV Active	Genesis Nexus Pinnacle ConnectTV ConnectTV Active
32"	Genesis Nexus Pinnacle ConnectTV	Genesis Nexus Pinnacle ConnectTV	Genesis Nexus Pinnacle ConnectTV			Genesis Nexus Pinnacle ConnectTV
42"	Genesis Nexus Pinnacle ConnectTV	Genesis Nexus Pinnacle ConnectTV	Genesis Nexus Pinnacle ConnectTV			Genesis Nexus Pinnacle ConnectTV
55"	Elite		Elite			Elite
65"	Elite		Elite			Elite
85"	Elite		Elite			Elite



# Compare LCD Features

	RG59/RG6/Aerial	Composite	Component	HDMI	VGA	Ethernet	HDBaseT	Coax Audio	PC Audio	RS232	Discrete IR	Full IP Control	HDBaseT.POH
Genesis	✓	✓	✓	3	✓	-	-	✓	✓	-	✓	-	-
Nexus	✓	✓	✓	3	✓	✓	-	✓	✓	✓	✓	-	-
Nexus+	✓	✓	✓	3	✓	✓	-	✓	✓	✓	✓	✓	-
Pinnacle	✓	✓	✓	2	✓	✓	-	✓	✓	✓	✓	-	-
Elite Ultra 4K	✓	✓	✓	3	✓	-	-	✓	✓	✓	✓	✓	-
ConnectTV	✓	✓	✓	3	✓	-	✓	✓	✓	-	✓	-	-
ConnectTV Active	✓	✓	✓	3	✓	-	✓	✓	✓	-	✓	-	✓



# Installation & Support

We aim to make our televisions the easiest product on the market to install...

However, should you need a little more help, this chapter will provide you with that information.

# Installing an Aquavision

## Frameless Installation Information

**Step 1** - Install all wiring including PSU supplied with back box, then place the back box in to the framed wall. If tiling, tile first.

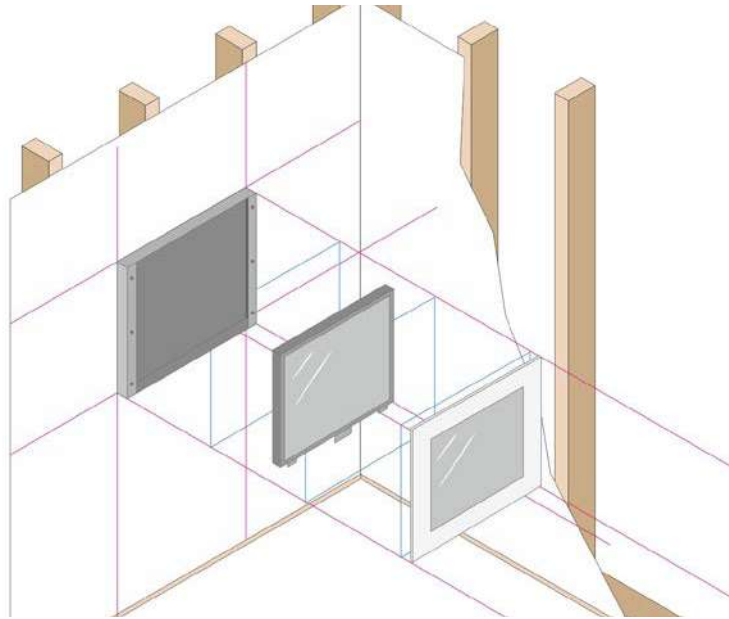

**Step 2** - Attach all wires including power and inputs. Then slot the television panel in and tighten up with plastic nuts provided.

**Step 3** - Position the glass so that the brackets align with the protrusions on the back box. Push in, then pull down to lock the glass into place.

## Ensuring the Frameless TV is Waterproof

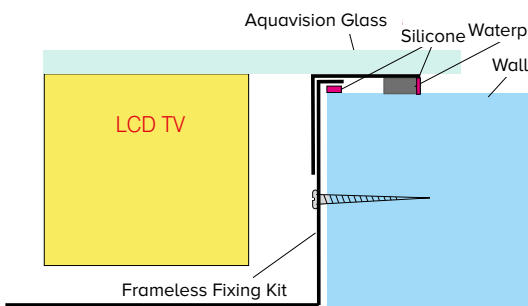

When installing the back box be sure to put a small amount of silicone around the inside of the lip. Once the television is tested and everything is working properly, complete the installation by putting a bead of silicone between the glass and wall. This will prevent the build-up of dust and soap and offer a double seal.

Screen Details	16"	22"	27"	32"	42"	55"
Screen size	15.6"	21.6"	27"	31.5"	42"	55"
Overall size	350 x 495	391 x 554	472 x 702	550 x 833	670 x 1028	815 x 1300
Cut-out size	322 x 448 x 50	352 x 520 x 50	437 x 656 x 50	517 x 790 x 60	638 x 985 x 60	760 x 1250 x 60
Screen depth	45	45	45	55	55	55
Back Box depth	50	50	50	60	60	60

65"	85"
65"	85"
1591 x 970	2500 x 1225
936 x 1540 x 60	1940 x 1160 x 100
55	95
60	100



# Classic Installation Information

Step 1 – Install the optional back box into the wall [recommended for wet or damp areas and for new construction].

Step 2 - Install the Classic bezel into the back box or wall [depending on whether you are using the back box].

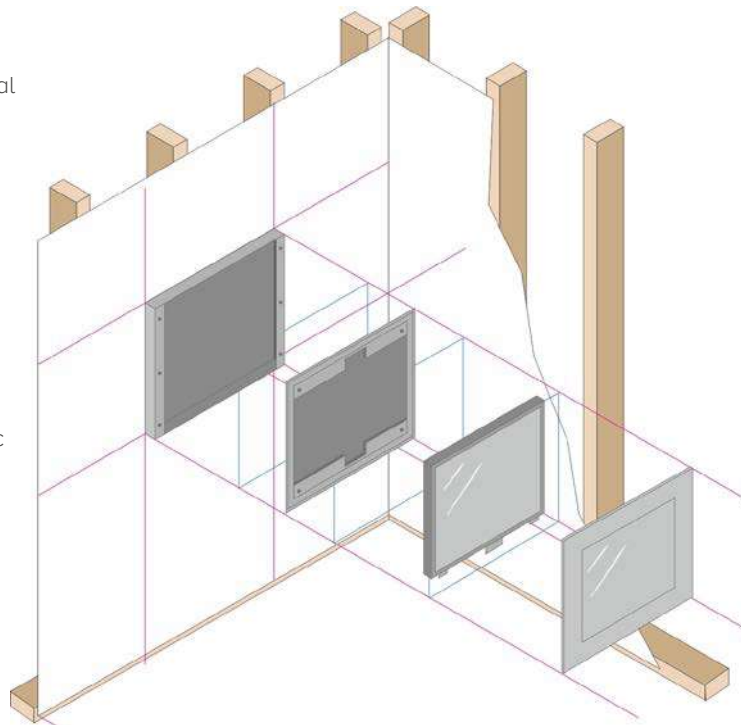

Step 3 - Attach all wires including power and inputs. Then slot TV Panel in and tighten up with nuts provided

Step 4 – Place the glass into the classic frame. Classic uses neodymium magnets to attach the mirror [It's a good idea to have a glass puller with you for minor adjustments to the magnets].

## Ensuring the Classic TV is Waterproof

Once the position has been defined, cut the hole in the wall to the cut-out dimensions below. Next, fit the two mounting brackets into the side holes of the Classic Bezel in either Fig 1 or 2 depending on the install. In Fig 1 the bracket is mounted to a stud. In Fig 2 the Bracket is used as a clamp between the front and back of a partition. Be sure not to overtighten the screws holding the front Bezel onto the brackets, as this can distort the frame and may hinder the glass from fitting properly.

Screen Details	22"	27"	32"	42"
Screen size	21.6"	26"	31.5"	42"
Overall size	412 x 575	492 x 722	692 x 1049	27¼" 41¼"
Cut-out size	402 x 566 x 50	483 x 718 x 50	562 x 845 x 60	685 x 1043 x 60
Screen depth	45	45	55	55
Back Box depth	50	50	60	60



# Silhouette Installation Information

Step 1 – Install the Silhouette frame onto the wall by the pre-drilled fixing holes.

Step 2 - Attach all wires including power and inputs. Then slot TV Panel in and tighten up with nuts provided

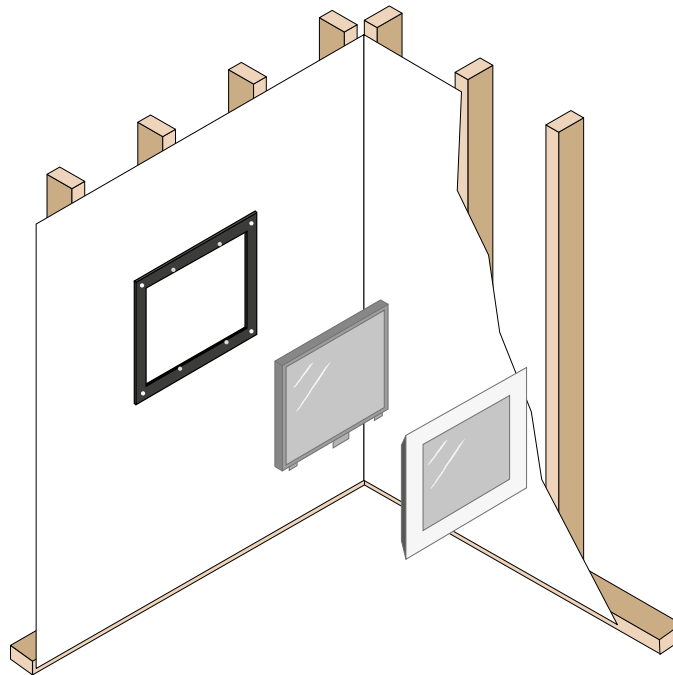

Step 3 – Place the glass into the frame. Silhouette glass uses neodymium magnets to attach the glass [It's a good idea to have a glass puller with you for minor adjustments to the magnets].

## Ensuring the Silhouette TV is Waterproof

Once the position has been defined, cut the hole in the wall for the cables. Next, apply a bead of silicone to the back of the silhouette frame. As you screw the frame on to the wall, make sure the silicone creates a thorough seal. Make sure to check grout lines etc. Once the glass is fitted, apply a bead of clear silicone between the glass and the Silhouette frame to ensure a complete waterproof seal. Failure to do this correctly could result in the warranty becoming void.

Screen Details	22"	27"	32"	42"	55"
Screen size	21.6"	26"	31.5"	42"	55"
Overall size	395 x 558 x 50	476 x 706 x 50	554 x 837 x 63	674 x 1032 x 63	819 x 1304 x 63
Cut-out size	-	-	-	-	-
Screen depth	1 7/8"	1 7/8"	2 1/8"	2 1/8"	2 1/8"
Back Box depth	50	50	60	60	60

65"	85"
65"	85"
974 x 1594 x 63	1229 x 2504 x 95
-	-
2 1/2"	2 1/2"
60	100



# Bespoke Options

Our Bespoke Range is available with our 22” to 65” televisions. The CMK and L Bracket system allows you to access the television from the front for service. The CMK mount can be mounted in a wall or directly on to the mirror itself.

**LCD in Wall** - The most popular and easiest way to use the CMK is to bond it to the glass itself. The television then mounts to the CMK just like our standard mounts but in reverse. This diagram shows installation with optional “L” brackets and magnets, as used on larger mirrors.

**L Bracket and Magnet** - When mounting the CMK on the wall the framing must be specific to the size of the CMK for a correct fit.

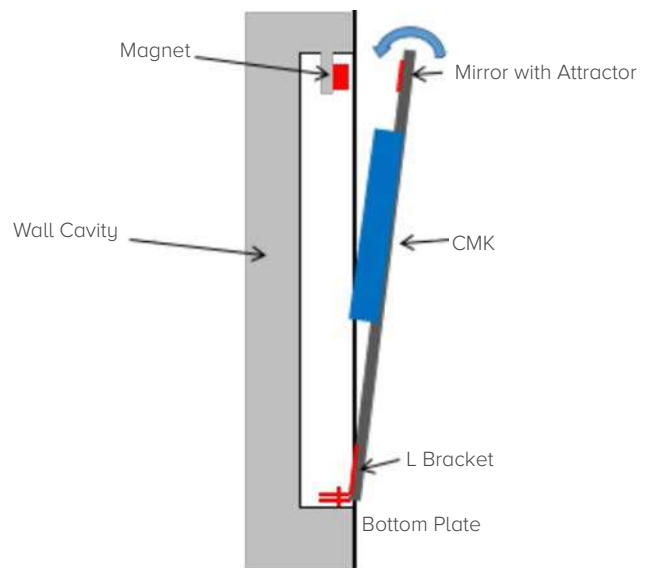

Model Number	Screen Size	CMK Dimensions
AVF16L-4CMK	16"	350 X 488 X 30
AVF22L-4CMK	22"	362 x 545 x 30
AVF27L-4CMK	27"	472 x 690 x 30
AVF32L-4CMK	32"	537 x 765 x 30
AVF42L-4CMK	42"	650 x 999 x 30
AVF55L-4CMK	55"	1280 x 808.4 x 60
AVF65L-4CMK	65"	1483 x 961 x 60
AVF85L-4CMK	85"	1950 x 1190 x 30

All CMK brackets have a depth of 2” except 65” and 85” which is 2½”





# Sauna/Steam Room Installation Details

Extreme environments include swimming pools, saunas and steam rooms.

For these environments we recommend only using the frameless models as the metal bezel can get very hot to touch. When you are installing your Aquavision in a Pool, Sauna, Steam Room or other extreme environment your LCD TV will need extra ventilation.

This is obtained by either of the following ways dependent upon the heat and the chosen option:

- At the back of the unit it may be necessary to fit two ventilation grilles. One of these should be below the LCD, the other above it. These should be large enough to allow sufficient uninhibited free air movement for convection cooling.
- The back box should be totally uncovered allowing convection cooling to happen.
- If the TV is installed directly over the heat generator, or if the heat of the screen is expected to be above 45°C (113°F), then forced air cooling will be required. For this the back box will need to be modified to allow forced air in at the bottom and to exit through vents at the top. A minimum of 60m<sup>2</sup> (70yds<sup>2</sup>) per hour is recommended for this.

In most cases, one of these three procedures will suffice. However, in some extreme cases, a certain degree of forced air will also be required between the glass and the LCD to facilitate adequate cooling of the screen front.

It is the installer's responsibility to ensure that the Aquavision is installed correctly and that there is adequate cooling. Aquavision takes no responsibility for damage caused by insufficient cooling or any other installation issue. The above is meant as a guide only and covers most applications. All cases differ and so should be looked at individually by the installer.



# Installing your Bang & Olufsen Board

First, you will need to install a replacement IR control board with our Bang & Olufsen board by following the instructions below

1. Remove and discard the original IR board from the bottom of the TV by unscrewing either 2 screws (old style) or 3 screws (new style) and carefully unplug the 14-way header cable from this board.
2. Install the new B&O board by placing the larger board behind the screen chassis and the smaller board in front. Make sure the IR receivers on the small board are in the middle as shown below.

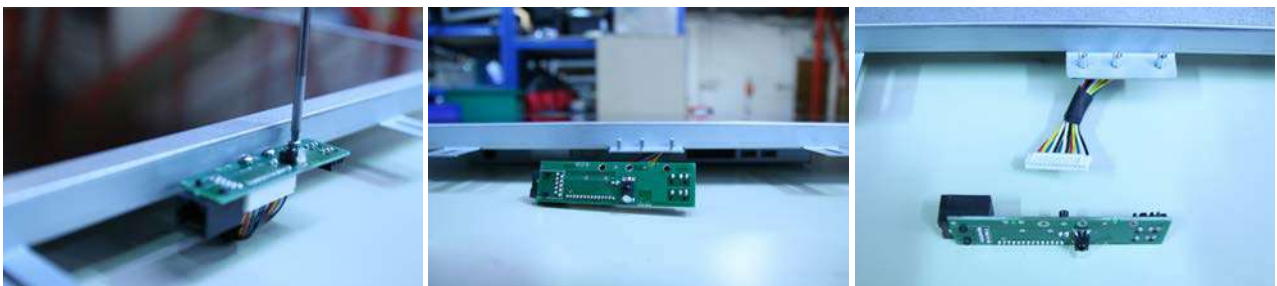

Unscrew, disconnect and discard the board supplied with your Aquavision

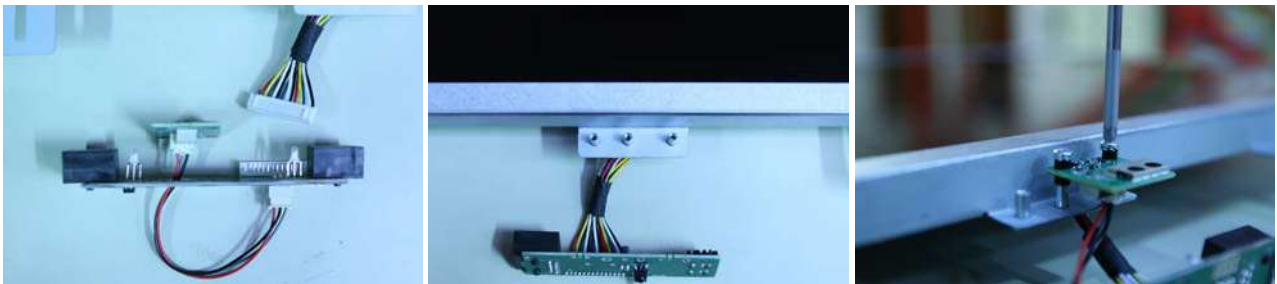

Connect the Bang & Olufsen board to the Aquavision and install the small daughter board as shown. When installing this board, dependent on the model and age of the television, you may need to use the spacers and longer screws [supplied]. This board should be installed on the front of the fixings as shown. Spacers could be used to lift the small board as high up as possible without it being above the front of the screen



Next install the larger board on the rear. Spacers/insulating wires [supplied] should be used where necessary as shown.



### 3. Once installed, this board will allow you to control your Aquavision in one of the following ways:

#### 1. Aquavision controlled by BeoSystem 4:

By using the AVF-B&OBRD replacement IR, two Cat5e or better cables are now connected in the sides of the PCB, one for IR in [J1] and one for PUK [J2].

- i. Enter the Setup menu on the BS4
- ii. Display setup
- iii. Download Aquavision WRC-5B PUC
- iv. Select choose PUC number and use "B"
- v. Press "Red" (Manual setup)
- vi. Press "Select"
- vii. Choose "Plug"
- viii. Choose "Modulation Off"

#### 2. Aquavision controlled by your Bang & Olufsen remote control:

For this feature, simply install the board as detailed above and don't connect anything into either of the RJ45 connectors.

The B&O remote works as detailed below:

BeoRemote One	Aquavision Remote	BeoRemote One	Aquavision Remote	BeoRemote One	Aquavision Remote
Play	Play	Long Green	Green	TTX	TTX
P+	P+	Long Yellow	Yellow	Vol+	Vol+
P-	P-	Long Blue	Blue	Vol-	Vol-
Skip Right	Right	Power Off	Power Off	0	0
Skip Left	Left	Power On	Power On	1	1
Pause	Pause	Menu Long	Menu	2	2
Back	Exit	Menu	Source	3	3
Guide	EPG Guide	OK Long	EPG Guide	4	4
Red	Red	OK	OK	5	5
Green	Green	Up	Up	6	6
Yellow	Yellow	Down	Down	7	7
Blue	Blue	DTV	DTV	8	8
Long Red	Red	Mute	Mute	9	9



# Relay Interface Module

The Aquavision Relay Interface Module provides two multipurpose potential free relay contacts which become active when your Aquavision TV is switched on.

A Relay Interface Module can be fitted to any Series 4, Nexus or Pinnacle range television and is compatible with all installed models.

The Module simply connects to the Remote Switch Panel connector on the television. If the Remote Switch Panel is also required then this connects in series with the Relay Interface Module.

- Includes the following applications:
- Switching external speaker source from an Audio device to your Aquavision when it is switched on
- Status signal to external audio systems
- Status signal for control systems
- External control LED mirror lights
- External control mirror demisting pads
- Maximum power on each terminal is:  
DC: 28V, 2A, 60W, AC 125V, 0.5A, 60 W

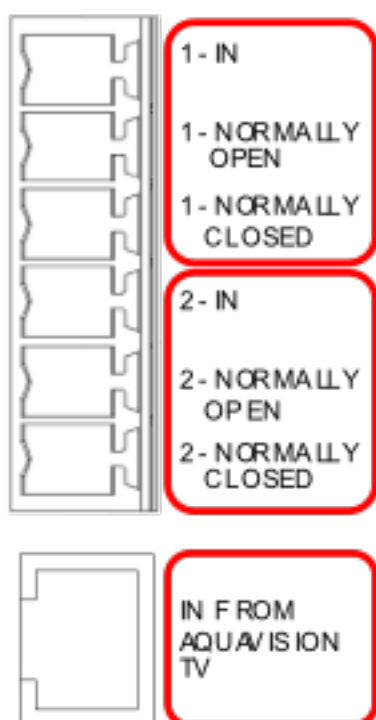

# Using the Relay Interface Module

The Aquavision AVF-5RLYF4P Relay Interface Module is designed for switching the sources to speakers enabling 2 independent sources to utilize the same ceiling speaker without interfering with each other.

This switching is done automatically when you power up your Aquavision and is not dependent on either source's volume setting.

Each speaker should be connected as shown below

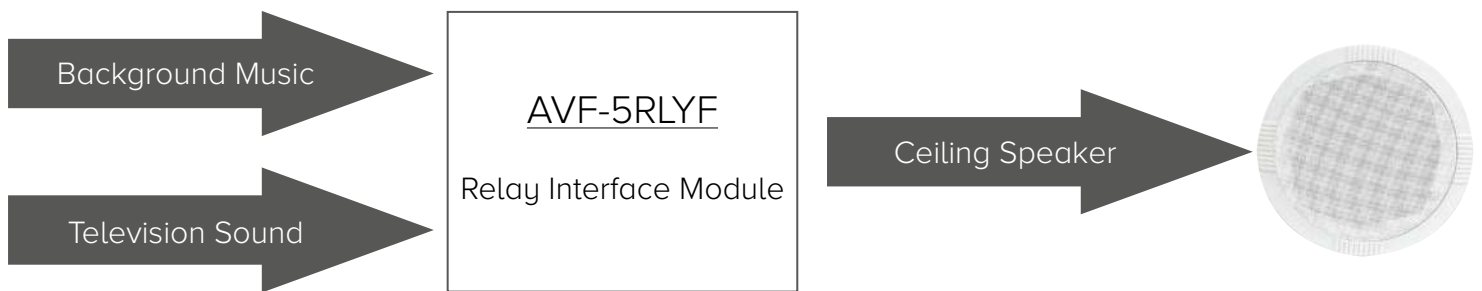

The Relay interface Module then plugs into the accessory port on the IR board at the bottom of your Aquavision:

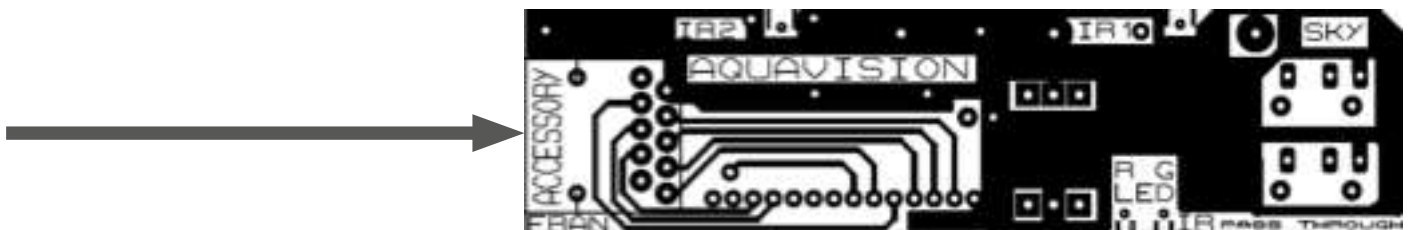

# Viewing Angles

## Why are Viewing Angles so important?

We are all familiar with laptops and realise that when someone is trying to show you something on their screen you sometimes have to adjust the angle of the screen to be able to see the image clearly. This is due to poor viewing angles on your laptop.

Now imagine you are sat in the bath, with your nice new bathroom TV installed in the wall and you can see it perfectly when you are standing up showering, but when you sit down the picture all but disappears. You can't simply adjust your wall, move the television or raise the bath to compensate for this.

This is why viewing angles are important!

Look at the picture below.

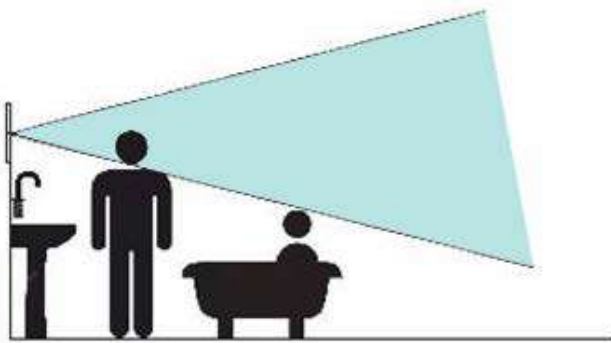

This shows a perfect picture when standing, but when you are sitting in the bath, you are outside the viewing angle of the panel. This means the picture disappears!

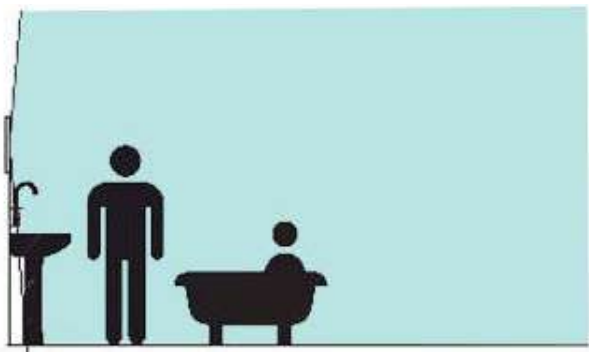

This picture above shows Aquavision's 178° x 178° viewing angle and how that gives you a perfect picture whether you are standing, sitting or even lying on the floor!

All Aquavision televisions are designed to give you the best viewing angles that is available on the market. That is 178° x 178°.



# Technical Features

Aquavision televisions can be used in all commercial and hospitality market sectors.

The next few pages should guide you through the steps to initiate 'Hotel Mode' on your Aquavision, as well as other sub-menus.

# Hotel Mode

All current Aquavision televisions have a “Hotel Mode” feature that allows you to set the following functions:

- Maximum Volume
- Initial Volume
- Initial Channel
- Initial Picture Status Memory (PSM)
- Initial Sound Status Memory (SSM)

On the Master Remote press press SOURCE, then numbers 2580 or the equivalent for your screen type below:

Screen Version	
S4A	Set Volume to 0, then press 9, 8, 7, 6
S4B	Press INFO STILL SLEEP MUTE, and then ENTER.
Genesis	Set Volume to 0, then press 9, 8, 7, 6
Genesis2	
Nexus/Nexus Lite	Press SOURCE, then press 2580
Pinnacle	
Elite 4K	Press, MENU then press 1147
Genesis ATSC	
Nexus ATSC	Press SOURCE, then press 2233
Pinnacle ATSC	

This will bring you to the Factory Settings menu as follows, or similar:

For Hotel Mode, scroll down to FUNCTION and press ENTER. On the next page scroll down to Hotel Mode and press the right arrow. This will now show as ON.

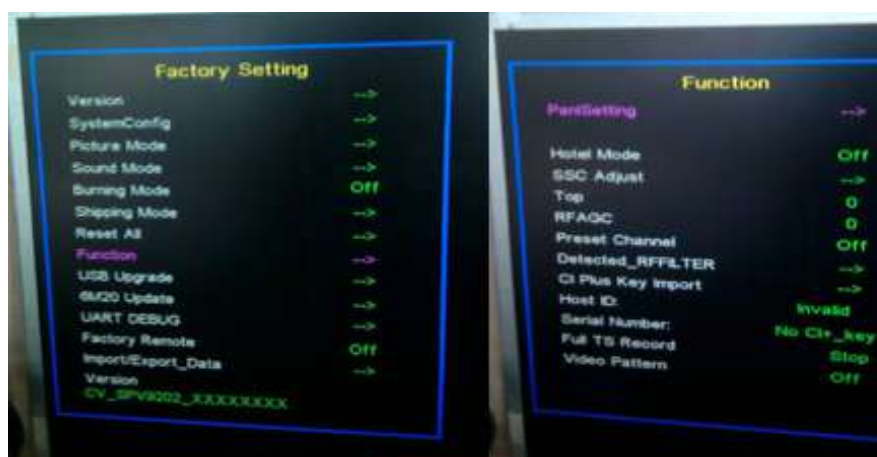

To Exit this Mode, Press the MENU button twice.





To access the Hotel Mode menu:

1. Enter Main Menu by pressing the Menu button  
 Enter the Main Menu subpage 'Feature' by pressing the right arrow.



2. Enter the Lock Item by pressing the right arrow  
 Enter the Lock Item using the password 0000 soft-key .



3. Enter The Hotel Mode Item by pressing the right arrow.



4. Turn the Hotel Mode ON using the OK/Right soft-key. Adjust settings accordingly. To EXIT press MENU

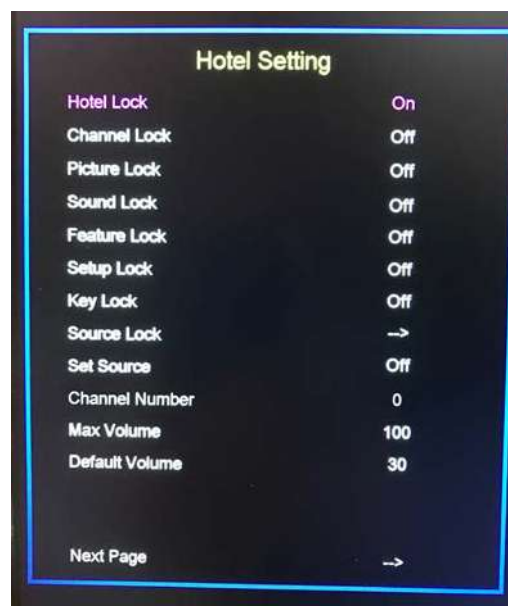

# Cloning Your TV Settings

On all current Aquavision models, you can also clone the information from the first television and upload it to all subsequent televisions. Do this as follows:

1. Insert a clean memory stick into the TV. Enter Hotel Mode as explained previously. Select the second page and you will see 'Export Hotel DB'.

Choose DataBase Export item using Right soft-key, Then the "OK" Item value will display. It will show Export OK. (This DB will have channel data, user settings data from the main menu and hotel settings data)

2. Check the DB  
Insert the USB device into your PC and you will see a folder named "CV\_512" Under this folder you will see a file "FlashData\_S2T502\_1.bin". This means that the DB has been exported successfully.

3. Enter Import Hotel DB Menu  
Insert the USB device (With the CV\_512 folder) into your Aquavision. Follow steps 1-4 to enter the Hotel Mode menu. On page 2 of the Hotel Mode menu choose the DataBase Import item using Right soft-key. Then the TV will show the DataBase Import menu as shown.

4. Import Hotel DB  
Choose the DB you want to import using Right soft-key. When it is completed the TV will restart.

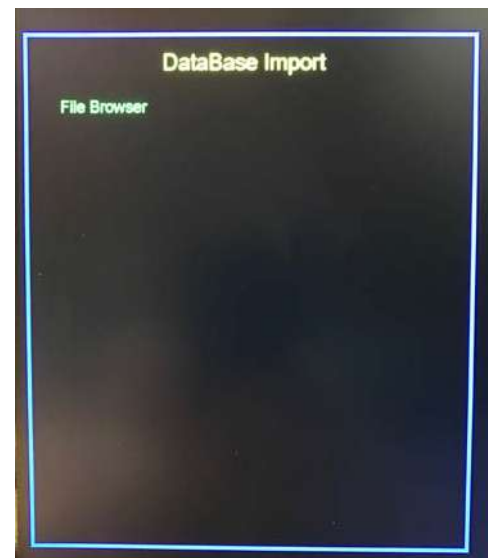

# Product Specifications

	16"	22"	27"	32"
Actual viewing area	15.6"	21.5"	27"	31.5"
	344 x 193	476 x 267	598 x 336.5	
	13 7/13" x 7 5/8 "	18 3/4" x 10 17/32"	23 9/16x 13 1/4"	27 1/2x 15 1/2 "
Actual Panel size	356.5 x 206.5 x 4	497.6 x 292.2 x 10.5	614 x 357 x 10	727.4 x 429 x 20
Viewing angle	85 x 85	89 x 89	89 x 89	89 x 89
Resolution	1920 x 1080	1920 x 1080	1920 x 1080	1920 x 1080
Response time	35mS	14mS	12mS	6.5mS
Contrast	800:01:00	1000:01:00	3000:01:00	3000:01:00
Brightness	220cd/m2	220cd/m2	300cd/m2	350cd/m2
Op. Temp	+122°F/50°C	+122° F/50°C	+122°F/50°C	+122°F/50°C
Op. Humidity	90%RH	90%RH	90%RH	90%RH
Storage Temp	+140°F/60°C	+140°F/60°C	+140°F/60°C	+140°F/60°C
Storage Humidity	90%RH	90%RH	90%RH	90%RH
IR center	42mm	35mm	36mm	50mm
CMK sizes	320 x 390 x 30	361 x 544 x 30	472 x 690 x 30	577 x 883 x 30
Backlight life	50,000 hrs	50,000 hrs	50,000 hrs	50,000 hrs
Audio Output	8w+8w RMS	8w+8w RMS	8w+8w RMS	8w+8w RMS

	42"	55" 4K	65" 4K	85" 4K
Actual viewing area	42"	54.6"	64.5	85
	698 x 392	930.24 x 523.26	1210 x 680	1872 x 1053
	36 5/8" x 20 5/8"	26 3/4" x 47 5/8"	31 3/4" x 56 1/4"	73 3/4" x 41 1/2"
Actual Panel size	958.2 x 551.1 x 27	1236 x 708.9 x 45.7	1450 x 828 x 30	1902 x 1083
Viewing angle	89 x 89	89 x 89	89 x 89	89 x 89
Resolution	1920 x 1080	3840 x 2160	3840 x 2160	3840 x 2160
Response time	8mS	6.5mS	6.5	-
Contrast	4000:01:00	4000:01:00	5000	3000.00
Brightness	350cd/m1	350cd/m2	350cd/m2	500cd/m2
Op. Temp	+122°?50°C	+122°F/50°C	+122°F/50°C	+50°C
Op. Humidity	90%RH	90%RH	90%RH	90%RH
Storage Temp	+140°F/60°C	+140°F/60°C	+140°F/60°C	+60°C
Storage Humidity	90%RH	90%RH	90%RH	90%RH
IR center	63mm	32mm	mm	38
CMK sizes	691 x 1095 x 30	1378 x 851 x 30	1483 x 961 x 60	1950 x 1190 x 30
Backlight life	50,000 hrs	50,000 hrs	50,000 hrs	30,000 hrs
Audio Output	8w+8w RMS	8w+8w RMS	8w+8w RMS	8w+8w RMS



# ConnecTV Active Module

MODEL	TUNER					INPUTS							SOUND			FEATURES						
	DVB-T	DVB-C	DVB-S2	DVB-T2	Analogue	USB	HDMI	SCART	Y,PB,PR	C+	VGA	AV	SPDIF - COAX	AUDIO OUT	AMPLIFIER OUT	RS232	SMART	IR IN/OUT	SKY Link	DISCRETE IR	HDBaseT	HDBaseT POH
ConnecTV/Active	Y	Y	Y	Y	Y	2	2	Y	-	-	Y	Y	Y	Y	Y	-	-	-	Y	-	-	-
	22"					27"							32"			42"						
Resolution	FHD					FHD							FHD			FHD						
Frameless																						
Cut Out (H x W x D)	352 x 520 x 50					437 x 656 x 50							517 x 790 x 60			638 x 985 x 60						
Overall Size (H x W)	391 x 554					472 x 702							550 x 833			670 x 1028						
Classic																						
Cut Out (H x W x D)	402 x 566 x 50					483 x 718 x 50							562 x 845 x 60			685 x 1043 x 60						
Overall Size (H x W)	412 x 575					492 x 722							571 x 854			692 x 1049						
Silhouette																						
Overall Size (H x W)	395 x 558 x 50					476 x 706 x 50							-			-						
Glass finishes																						
Black	yes					yes							yes			yes						
Polar White	yes					yes							yes			yes						
MirrorVision	yes					yes							yes			yes						
MirrorVision+ (Special order only)	yes					yes							yes			yes						

## LCD Television Options

Aquavision offer from 22" to 40/42" LCDs with ConnecTV receivers built in and 22" & 27" LCD with ConnecTV-Active receivers built in. These products are compatible with all standard Aquavision mounting options, i.e. Classic, Frameless, Silhouette & Bespoke and are compatible with all glass styles.

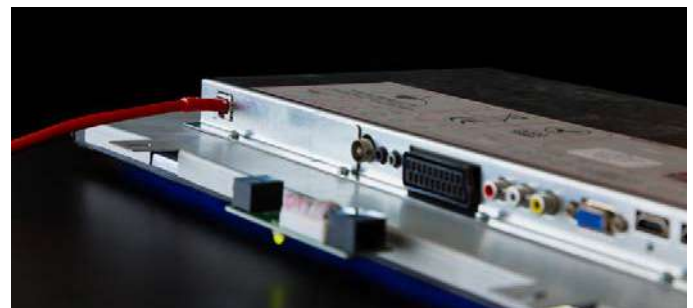

## Transmitter Boxes

### AVFCT-TX – HDBaseT Transmitter

Simply connect to your source via HDMI and IR and then connect to your ConnecTV via a CAT5E or greater cable. Power supply provided.

### AVFCA-TX - HDBaseT Transmitter with POH

Simply connect to your source via HDMI and IR and then connect to your Aquavision ConnecTV-Active via a Cat5E or greater cable. This will enable you to provide power and signal to the television via the one single cable. Power supply provided.



# IR Board Connection Details

On current IR boards there are 2 x 3.5mm sockets, one marked and SKY and the other as IR PASS THROUGH, an RJ48 [10 way] plug, and there are also 4 'SNAP'S' labelled as IR1, IR2, R & G

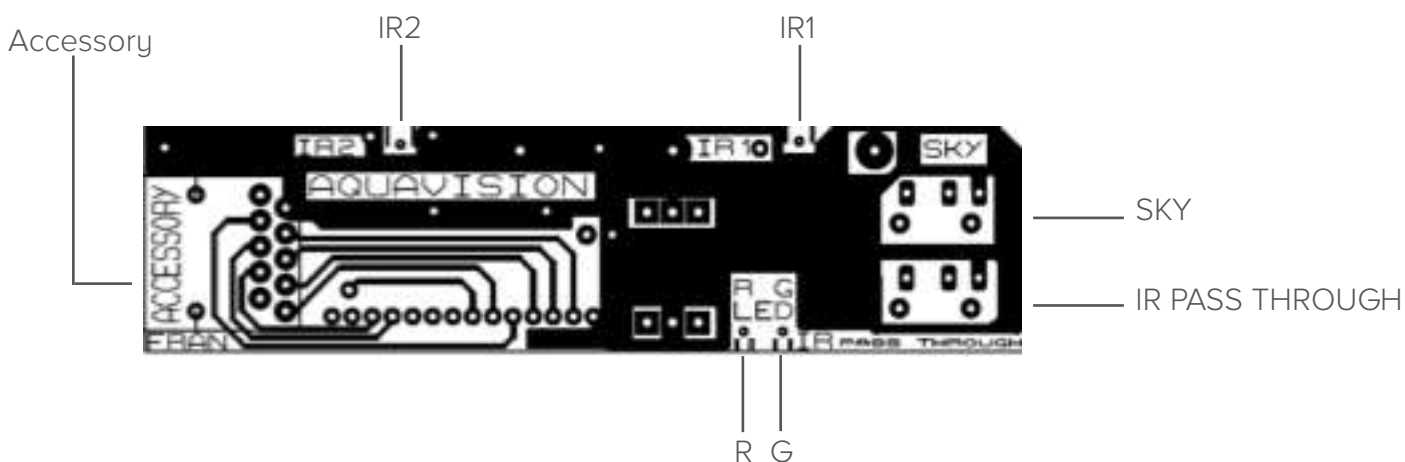

The jack plugs are wired as follows:

Connector Details	Tip	Ring	Sleeve
SKY	IR Signal (3.7V 8.1KOhm)	VCC (5V 100Ohm)	Ground
IR Pass Through	VCC (5V 100Ohm)	IR Signal (3.7V 8.1KOhm)	Ground

This is an unmodulated signal.

There are also 4 "SNAPS". These simply snap off should you want the following features:

- IR1 - Snapping this off stops the IR Signal going to the Aquavision but it keeps it present on both IR sockets
- "R" - This turns off the Red power LED
- "G" - This turned off the Green power LED

The accessory socket is for use with our AVF-RSP5, wall mount switch panel and is cabled in as follows:

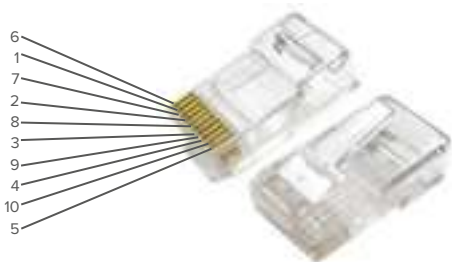

RJ48 pin number	Function	RSP 5 Switch Position
PIN 1	GND/0V	
PIN 2	ON/OFF	Top centre
PIN 3	VOL+	Top right
PIN 4	VOL-	Bottom right
PIN 5	PG+	Top left
PIN 6	PG-	Bottom left
PIN 7	TV/AV	Bottom centre
PIN 8	LED G	centre
PIN 9	LED R	centre
PIN 10	5V/VCC	



# Legacy Product IR Codes [MK1-3]

	10.4", 15" and 17"	23", 26", 32", 40"	23", 26", 32" USA	17BLF	23BLF
0x00	0	0	0	0	0
0x01	1	1	1	1	1
0x02	2	2	2	2	2
0x03	3	3	3	3	3
0x04	4	4	4	4	4
0x05	5	5	5	5	5
0x06	6	6	6	6	6
0x07	7	7	7	7	7
0x08	8	8	8	8	8
0x09	9	9	9	9	9
0x0A		*(LEFT)	*(LEFT)		*(LEFT)
0x0B		*(RIGHT)	*(RIGHT)		*(RIGHT)
0x0C	POWER	POWER	POWER	POWER	POWER
0x0D	MUTE	MUTE	MUTE	MUTE	MUTE
0x0E	PSM	PSM	PSM	PSM	PSM
0x0F					
0x10	VOL +	VOL +	VOL +	VOL +	VOL +
0x11	VOL -	VOL -	VOL -	VOL -	VOL -
0x12					
0x13				VIDEO	VIDEO
0x14	SCART				
0x15				TV	TV
0x16		SSM	SSM	SSM	SSM
0x17					
0x18					
0x19		TV/PC	TV/PC	PC/TV	TV/PC
0x1A	VIDEO	ARC	ARC	ARC/*	ARC
0x1B	S-VIDEO	INPUT	INPUT		INPUT
0x1C		SWAP	SWAP		SWAP
0x1D		MODE	MODE		MODE
0x1E	ARC	PR + [PIP]	CH +[PIP]		PR + [PIP]
0x1F	PC	PR - [PIP]	CH -[PIP]		PR - [PIP]
0x20	PR +	PR +	CH +	PR +	PR +
0x21	PR -	PR -	CH -	PR -	PR -
0x22				S-VIDEO	S-VIDEO
0x23		I/II	SAP		I/II
0x24				PC	PC
0x25	OK	OK	OK	OK	OK
0x26		SLEEP	SLEEP		SLEEP
0x27					
0x28					
0x29	SLEEP	HOLD		HOLD	HOLD
0x2A	TIME	TIME		TIME	TIME
0x2B	SIZE	Q.VIEW	Q.VIEW	SIZE	Q.VIEW
0x2C	REVEAL	REVEAL		SYSTEM	REVEAL
0x2D	UPDATE	UPDATE		UPDATE	UPDATE
0x2E				MIX	
0x2F					
0x30		POSITION	POSITION		POSITION
0x31					
0x32	SSM	YELLOW		LIST	YELLOW
0x33					
0x34		CYAN		Q.VIEW	CYAN
0x35	INDEX	LIST	LIST	INDEX	LIST
0x36	GREEN[I/II]	GREEN		SLEEP	GREEN
0x37		RED		I/II	RED
0x38	CYAN[TV/AV]	TV/AV	TV/AV	TV/AV	TV/AV
0x39	YELLOW[Q.VIEW]				
0x3A		PIP	PIP		PIP
0x3B	RED[MENU]	MENU	MENU	MENU	MENU
0x3C	TEXT/MIX	TEXT/MIX	CC	TEXT	TEXT/MIX
0x3D					
0x3E	ON				
0x3F	OFF				



# Installing your Control 4 IR Board

## Control 4™

- Snap off the 'IR' tab from the IR Board as shown with an arrow below. Should your IR board be an older version and not look like this, please contact your Aquavision office to arrange for a replacement board to be supplied.

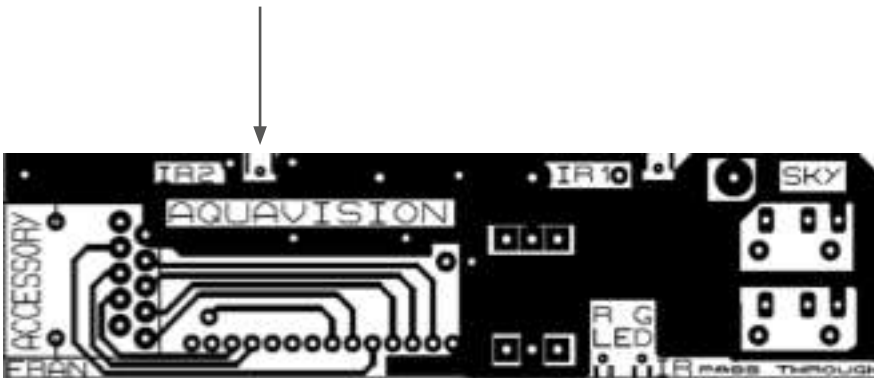

- Plug a standard 3 pole 3.5mm jack to jack lead into the top socket marked "SKY"

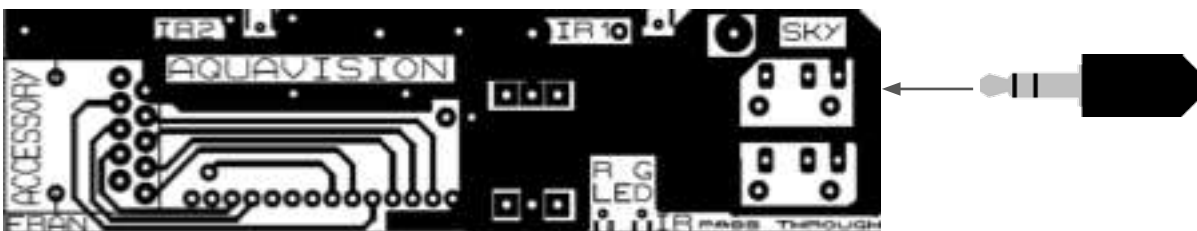

- Download Aquavision Series 5 driver (Aquavision\_Series 5\_IR.c4i.) from the Control4 or Aquavision website and once installed, this will work correctly



# IP/RS232 Set Up Instructions

## Instructions on how to set up your IP Address

Your Aquavision is shipped with a static IP address; this can be changed to DHCP from the internal webpage.

Factory Settings are:	IP Address	192.168.1.11
	Subnet Mask	255.255.255.0
	Default Gateway & DNS	192.168.1.254
	IP Command Port is	3300
	Baud Rate	115200
	Webpage	192.168.1.11/setup

To reset back to factory settings as above press and hold the reset switch located between the RS232 and the Ethernet socket on the Aquavision for 10 seconds.

Please note: There has to be a 10 second gap between loading or refreshing the internal setup webpage and sending an IP command and vice versa.



## Instructions on how to set up Hercules for IP Control:

- Select the TCP Client tab
- Type the IP address of the unit you wish to control
- Type the Port, factory default is 3300
- To turn TV on click type POWR01#013 and then click connect, Click send
- To turn TV on click type POWR00#013 and then click connect, Click send
- To turn the TV menu on/off click type MENU00#013 and click connect click send

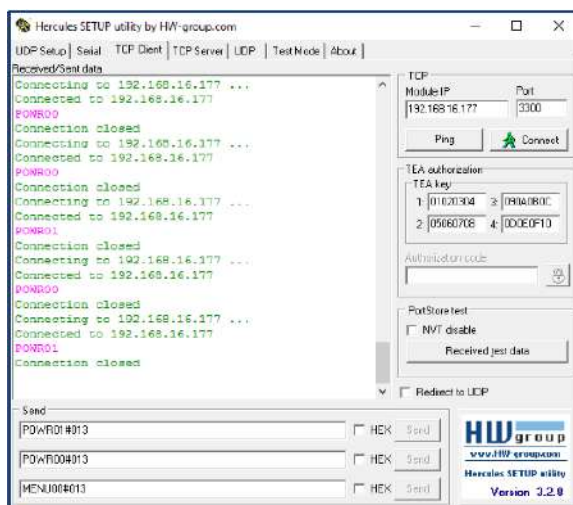

## Instructions on how to set up Hercules for RS232 Control:

Hercules can be used as a standard RS232 client as well as a TCP client as featured above.

- Select the Serial Tab
- Settings down the right hand side need to be:
  - Your COM port
  - Baud, 115200
  - Data Size, 8
  - Parity, none
  - Handshake, Off
  - Mode, Free

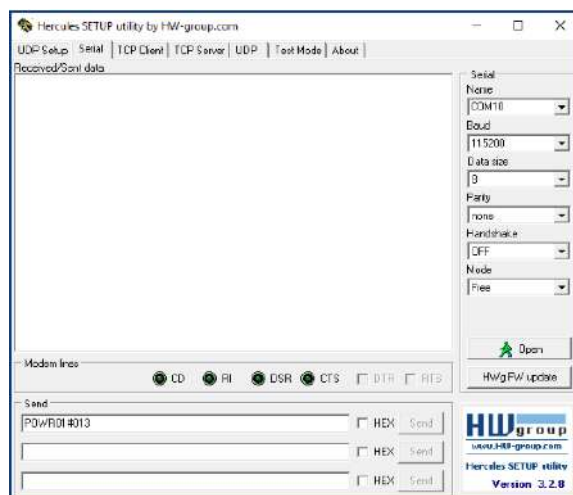



## Instructions on how to set up Putty for RS232 Control

- Load Putty from the main screen
- Serial setup for European TV
- Serial line, Your COM Port
- Speed, 115200
- Select, Serial radio button

(see attached pictures)

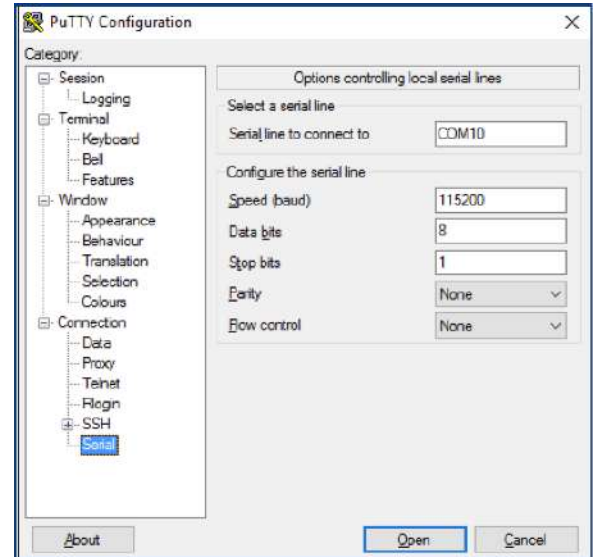

Under Category left hand side select Serial.  
Again check your:

Serial line to connect to, Your COM Port  
Speed (baud), 115200

Data bits, 8  
Stop bits, 1  
Parity, None  
Flow Control, None

When you load the terminal after entering the details above  
in Putty you may have to hit enter to show something on the  
screen.

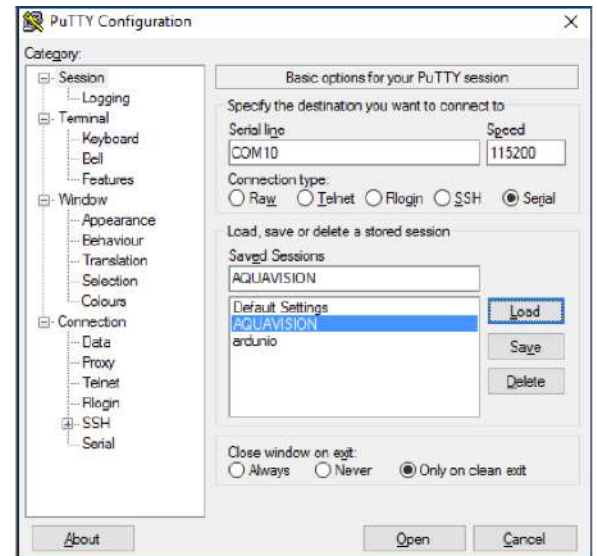

## Instructions on how to set up Hyperterminal for RS232 Control

Set up the connection as follows  
Serial line to connect to, Your COM Port  
Speed (baud), 115200

Data bits, 8  
Stop bits, 1  
Parity, None  
Flow Control, None

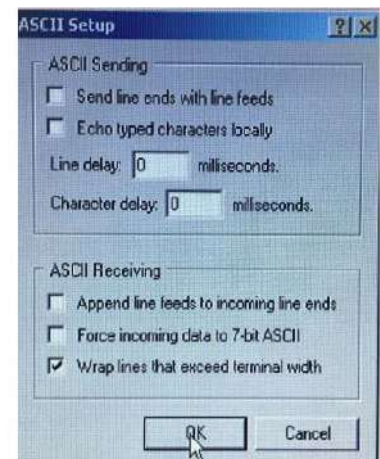
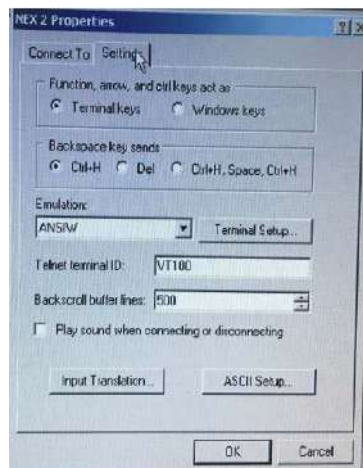

# Satellite List Editing

## 1. Preparation work

Under the Satellite TV connection mode.  
 (See pic 1) Search the satellite which you want to prelist. Then put a clean USB memory stick in the USB port in the Nexus main board.

## 2. Enter Factory Setting

Enter Factory Setting using SOURCE and 2 5 8 0 soft-keys (See pic 2), and select the Import/Export\_Data Item.

## 3. Export Satellite DB

Export Satellite DB using Right soft-keys, The "OK" Item value will then display. It shows that the DataBase export is now complete.

## 4. Check the DB list

Remove the memory stick from the Nexus and insert in your PC. You will see a folder named "CV\_512" Under this folder you will see a file "CV\_DBS.bin". It shows that the prelist is now exported OK. Edit as required

## 5. Import Satellite DB

Push the USB device (With the CV\_512 folder) into your Nexus motherboard USB input. Choose the Satellite TV connection mode like step 1.

Repeat steps 2 and 3 in the factory menu.  
 (See pic 4). Choose the Import Satellite DB item using Right soft-key. Then the TV will restart with the programs displaying in the chosen order.

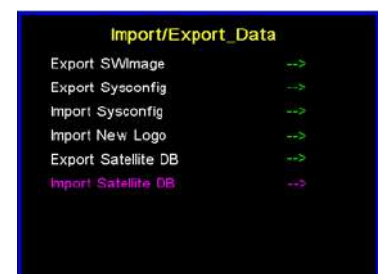
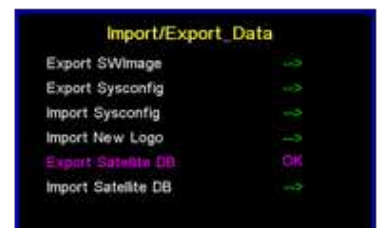

# Upgrades and Spare Parts

Ensuring long term customer  
satisfaction since 1997

# Upgrade Kits & Spares

## Upgrading your old Aquavision Screen

We understand that a hole in the wall for our product is a long term commitment - a commitment that may actually last longer than the television or its related technology, so you may have the need to upgrade to a newer model in the future.

As a responsible manufacturer who cares about its customers, we offer upgrade kits for every size television we have ever made. For our customers, this means that the hole made in the wall will never be obsolete. Upgrading your old Aquavision is a simple, straightforward process.

First you will need to identify your product from the tables below. Once your new upgrade has arrived, to install it you will need to:

- Remove the glass
- Unscrew the television
- Remove the cables from the TV
- Remove the power supply
- Dispose of these 3 items
- Install the new power supply
- Connect all cables
- Screw in the replacement TV
- Fit the new glass
- Power the television on and tune it in

Once you are happy all features are working correctly, don't forget to apply the bead of silicone as shown in the installation instructions.





Current LCD Model	Description	Format	Fitting	RS232	Overall Glass Size	New LCD Size	Kit Type
AVF151-LCD	15" MK1	4:3	Flush	N	399 x 450mm	16"	AVF16L-GUPGRADE7
AVF151-2LCD	15" MK2	4:3	Classic	N	364 x 449mm	16"	AVF16L-GUPGRADE3
AVF151-3LCD	15" MK3	4:3	Classic	N	364 x 449mm	16"	AVF16L-GUPGRADE3
Aquapack	17" "all in one"	16:9	T-Rail	N	344 x 430mm	16"	AVF16L-GUPGRADE13
AVF171-LCD	17" MK1	4:3	Flush	N	355 x 481mm	16"	AVF16L-GUPGRADE12
AVF17-3LCD	17" MK3	4:3	Classic	N	364 x 449mm	16"	AVF16L-NUPGRADE3
AVF17-4LCD	17" Series 4	4:3	Classic	Y	364 x 449mm	16"	AVF16L-NUPGRADE6
AVF17-4BLCD	17" Series 4 Basic	4:3	Classic	N	364 x 449mm	16"	AVF16L-GUPGRADE3
AVF17-2LCD	17" MK2	16:9	Classic	N	350 x 495mm	16"	AVF16L-GUPGRADE1
AVF17-3LCD	17" MK3	16:9	Classic	N	350 x 495mm	16"	AVF16L-GUPGRADE1
AVF17W-4SLCD*	17" Series 4 Wide Type S	16:9	Classic	N	350 x 495mm	16"	AVF16L-GUPGRADE1
AVF17W-4ALCD*	17" Series 4 Wide Type A	16:9	Classic	Y	350 x 495mm	16"	AVF16L-NUPGRADE4
AVF17W-4SLCD*	17" Series 4 Wide Type S	16:9	Frameless	N	350 x 495mm	16"	AVF16L-GUPGRADE2
AVF17W-4ALCD*	17" Series 4 Wide Type A	16:9	Frameless	Y	350 x 495mm	16"	AVF16L-NUPGRADE5
AVF19-4LCD	19" Series 4	16:9	Classic	Y	350 x 495mm	16"	AVF16L-NUPGRADE4
AVF19-4SLCD	19" Series 4 Basic	16:9	Classic	N	350 x 495mm	16"	AVF16L-GUPGRADE1
AVF19-4LCD	19" Series 4	16:9	Frameless	Y	350 x 495mm	16"	AVF16L-NUPGRADE11
AVF19-4SLCD	19" Series 4 Basic	16:9	Frameless	N	350 x 495mm	16"	AVF16L-GUPGRADE2
AVF20-4LCD	20" Series 4	16:9	Classic	Y	350 x 495mm	16"	AVF16L-NUPGRADE4
AVF20-4LCD	20" Series 4	16:9	Frameless	Y	350 x 495mm	16"	AVF16L-NUPGRADE11
AVF23-1LCD	23" MK1 LCD	16:9	Flush	N	450 x 640mm	22"	AVF-23UPGRADEKIT1
AVF23-2LCD	23" MK2 LCD	16:9	Classic	N	429 x 609mm	22"	AVF-23UPGRADEKIT2
AVF24-All models		16:9	Either	Optional	472 x 702mm	27"	Current range LCD + Glass
AVF26L-All models		16:9	Either	Optional	472 x 702mm	27"	Current range LCD + Glass
AVF32-All models		16:9	Either	Optional	550 x 833mm	32"	Current range LCD + Glass

### Notes:

- All Upgrade kits are supplied with MirrorVision or MirrorVision+ glass as standard
- All upgrade kits are guaranteed for 1 year, back to base warranty
- For all Frameless and Classic fitting kits you will need to purchase AVF-SCUP to aid removal
- All kits must be installed as stated in the instructions or the warranty may be void



## Power Supplies

Part Number	Model/Screen Size	Power Type	AC in Range	Current [Standby]	Connector Type
AVPSU5	MK1-3 all sizes Series 5 16" and Echo	Adaptor [12V/3.5A]	90-264V 50-60Hz	0.40A	
AVF-PSU6	Series 4 10" - 26"	Adaptor [12V/6.7A]		0.40A	
AVF-PSU24V3A	Series 5 22" - 42"	Adaptor [24V/3A]		0.12A	
AVF-PSU24V6A	Series 4 32"-40" Series 5 55"	Adaptor [24V/6.7A]		0.12A	
AVF-PSU24V9.2A	Series 5 65"	Adaptor [24V/9.2A]		0.12A	

## Accessory Codes

Part Number	Description
AVPSU5	MK1-3, Series 5 16" & Echo 12V/3.5A
AVF-PSU24V6A	Series 4 15" - 17" 12V/6A
AVF-PSU24V3A	Nexus, Genesis, & Pinnacle 22"-42" 24V/3A
AVF-PSU6	Series 4 26" - 42" & Elite 55" 24V/6.7A
AVF-PSU24V9.2A	Elite 65" 24V/9.2A
AVMRC-1	MK2/3 15/17/23 Master Remote Control
AVMRC-3	MK3 26/32/40 Master Remote Control
AVMRC-4	Series 4 Master Remote Control
AVMRC-5	Series 5 Master Remote Control
AVWRC-1A	MK3 15/17/23 Waterproof Remote Control
AVWRC-2	MK3 26/32/40 Waterproof Remote Control
AVWRC-5	Series 5 Waterproof Remote Control



# Remote Controls

Different models of Aquavision Televisions require different remote controls. Your television would have originally been supplied with two remote controls, one master and one waterproof. Aquavision can supply replacement remote controls for the majority of televisions supplied, however the new remote may look different to the one you were originally supplied with but the operation will be the same

## Master Remote Controls

This is generally a larger remote with more buttons and is used for setting up and programming. You will require the Master Remote Control for adjusting menu settings.

Suitable for: 15", 17", 23" [Mk1, Mk2, Mk3]  
Aquavision Part Number: AVMRC-1A

Suitable for: Aquavision Series 4  
Aquavision Part Number: AVMRC-4

Previous version:

Current Version:

Previous version:

Current Version:



Suitable for: 26", 32", 40" [Mk3]  
Aquavision Part Number: AVMRC-3

Suitable for: Aquavision Series 5 (Genesis, Nexus, Pinnacle)  
Aquavision Part Number: AVMRC-5

Previous version:

Current Version:

Previous version:

Current Version:



# Waterproof Remote Controls

These remotes are smaller than the Master Remote Controls and have fewer buttons. They are designed for day to day use with limited functions such as vol+/- and ch+/- etc.

*NOTE: There is a part number along the bottom of your Waterproof Remote control which will identify the television model you have.*

Suitable for: 15", 17", 23" [Mk1, Mk2, Mk3]  
Aquavision Part Number: AVWRC-1A

Suitable for: Aquavision Series 4  
Aquavision Part Number: AVWRC-1A

Previous version:

Current Version:



Previous versions:

Current Version:



Suitable for: 26", 32", 40" [Mk3]  
Aquavision Part Number: AVWRC-2

Suitable for: Aquavision Series 5 (Genesis, Nexus, Pinnacle)  
Aquavision Part Number: AVWRC-5

Current Version:

Current Version:



# Replacement Remote Controls

LCD Part Number	Description	Format	Fitting	Overall Size	Master RC	Waterproof RC
AVF151-2LCD	15" MK2	4:3	Bezel	385 x 470mm	AVMRC-1	AVWRC-1A
AVF151-3LCD	15" MK3	4:3	Bezel	385 x 470mm	AVMRC-1	AVWRC-1A
AVF17-2LCD	17" MK2	16:9	Bezel	371 x 516mm	AVMRC-1	AVWRC-1A
AVF17-3LCD	17" MK3	16:9	Bezel	371 x 516mm	AVMRC-1	AVWRC-1A
AVF23-3LCD	23" MK3	16:9	Bezel	450 x 600mm	AVMRC-1	AVWRC-1A
AVF26-3LCD	26" MK3	16:9	Bezel	492 x 722mm	AVMRC-3	AVWRC-2
AVF32-3LCD	32" MK3	16:9	Bezel	571 x 854mm	AVMRC-3	AVWRC-2
AVF40-3LCD	40" MK3	16:9	Bezel	692 x 1049mm	AVMRC-3	AVWRC-2
AVF17-4LCD	17" Series 4	4:3	Bezel	385 x 470mm	AVMRC-4	AVWRC-5
AVF17-4BLCD	17" Series 4 Basic	4:3	Bezel	385 x 470mm	AVMRC-4	AVWRC-5
AVF17W-4SLCD*	17" Series 4 Type S	16:9	Frameless	350 x 495mm	AVMRC-4	AVWRC-5
AVF17W-4ALCD*	17" Series 4 Type A	16:9	Frameless	350 x 495mm	AVMRC-4	AVWRC-5
AVF19-4LCD	19" Series 4	16:9	Bezel	371 x 516mm	AVMRC-4	AVWRC-5
AVF19-4BLCD	19" Series 4 Basic	16:9	Bezel	371 x 516mm	AVMRC-4	AVWRC-5
AVF20-4LCD	20" Series 4	16:9	Bezel	371 x 516mm	AVMRC-4	AVWRC-5
AVF26-4LCD	26" Series 4	16:9	Bezel	492 x 722mm	AVMRC-4	AVWRC-5
AVF32-4LCD	32" Series 4	16:9	Bezel	571 x 854mm	AVMRC-4	AVWRC-5
AVF40-4LCD	40" Series 4	16:9	Bezel	692 x 1049mm	AVMRC-4	AVWRC-5



# Credit Account Application Forms





# UK Credit Account Application

Business Type: Limited Company\_\_\_\_\_ Partnership\_\_\_\_\_ Sole Trader\_\_\_\_\_ Other\_\_\_\_\_

## Business Details:

Company Name Trading As			
Registered Address			
Post Code		Company Reg No. (if applicable)	
VAT Number		Country of Trading	

## Trading Address if different:

Address		
	Post Code	

## Accounts Address if different:

Address		
	Post Code	

## Bank/Building Society Details:

Name			
Address			
Postcode		Post Code	

## Company Contact Details

Department	Name	Telephone Number	Email
Purchasing			
Invoicing			
Payments			

## Showroom Contact Details (if more than one showroom please add details on next page)

Showroom Contact		
Telephone Number		
Email Address of sales contact		

## Name and Address of Partner 1

Name			
Address			
Post Code		Email	

## Name and Address of Partner 2

Name			
Address			
Post Code		Email	

## For Office use only

Sage Ref	HSBC Ref	Date Approved	Credit Limit	Discount	REP	Displaying Outlet	Business Type



SHOWROOM DETAILS

*Note: PLEASE COMPLETE FOR ALL SHOWROOMS*

Showroom contact	
Telephone number	
Email address of sales contact	

\*Aquavision request all showrooms to have a display unit installed, connected with Point of Sale literature available at all times. (Photos to be sent to: [marketing@aquavision.tv](mailto:marketing@aquavision.tv))

Showroom contact	
Telephone number	
Email address of sales contact	

Showroom contact	
Telephone number	
Email address of sales contact	

\*A reciprocal link to the [www.aquavision.tv](http://www.aquavision.tv) website is required in order for your showroom details to be published live on Aquavision's website.



# CONDITIONS OF SALE

## 1. GENERAL

The following are the terms and conditions of Aquavision distribution Limited.

- a) "Seller" means the party providing the goods or services under these terms and conditions.
- b) "Buyer" means the party contracting with the Seller to acquire the good and/or services supplied under these terms and conditions.
- c) "Goods" means all goods (by way of intermediate or finished product) and services supplied by the Seller to the Buyer.
- d) "Insolvency" means the Buyer is in a position where it is unable to pay its debts, or has a winding up petition issued against it, or has a receiver, administrator or administrative receiver appointed to it, or being a person, commits an act of bankruptcy, or has a bankruptcy petition issued against him.

All quotations, contracts and orders are made and accepted only upon these conditions unless expressly varied in writing by the Seller; no modification, variation or amendment of these conditions by the Buyer, whether in writing or otherwise shall have any effect.

## 2. VALIDITY OF QUOTATION

Unless otherwise stated or previously withdrawn, every quotation is open for acceptance within thirty days only from its date, and, if required by the Seller, is subject to approval of the Buyer's credit. Acceptance is subject to goods being unsold at the date of receipt thereof.

## 3. CANCELLATION

- a) The contract or order can only be cancelled by the Buyer, with the written consent of the Seller, which if given shall be deemed to be on the express condition that the Buyer shall indemnify the Seller against loss, damage, claim or actions arising out of such a cancellation, unless otherwise agreed in writing.
- b) The Seller is relieved of its obligation hereunder wherever and to the extent to which fulfilment or delivery is prevented, frustrated or impeded as a consequence of any circumstances outside its control including without prejudice to the generality of this provision, strikes, lock outs, trade disputes, breakdown, accidents, hostilities, Acts of God, shortage of materials or labour or any cause beyond the Seller control, force majeure or legalisation, regulation or orders issued by any government or local authority.
- c) In the event of the Buyer not having paid for any previous order or delivery in accordance with the Seller's settlement terms, the Seller may at its discretion, withhold delivery until payment has been received or cancel outstanding deliveries or orders.
- d) In the event of the Buyer entering into insolvency, the Seller may at its discretion, cancel any further deliveries.
- e) In the event of the Seller exercising its option under c) and/or d) this does not relieve the Buyer of any liability or obligation he had under this contract.

## 4. DELIVERY, TITLE & RISK

- a) Any stated delivery date period or rate shall not be of the essence of the contract, but is given as a guide only and whilst the Seller will make every effort to adhere to proposed timescales, the Seller accepts no responsibility for loss or damage resulting from delay, howsoever arising.
- b) If for any reason the Buyer is unable to accept delivery of the goods at the time when the goods are due and ready for delivery, the Seller shall, if its storage facilities permit, store the goods and the Buyer shall be liable to the Seller for the reasonable cost (including insurance) of its so doing. This provision shall be without prejudice to any other claim which the Seller may make in respect of the Buyer's failure to take delivery at the appropriate date.
- c) Delivery in the United Kingdom is ex Works Carriage Charged. Unless orders exceed a certain value which may from time to time be decided by the Seller in which event method of carriage is at the Seller's option and any special requirement of the Buyer will be charged for. Goods exported, unless otherwise agreed, will take place F.O.B. ex the Seller works. All packaging, duties and associated costs will be charged to the Buyer.
- d) The risk of the goods shall pass to the Buyer at the point of delivery specified in the order acknowledgement form.
- e) Notwithstanding delivery and the passing of risk, the property in the goods shall remain in the Seller unit until the Buyer has paid all monies owed by it to the Seller under this or any other contract or otherwise.
- f) If any of the goods supplied by the Seller are processed into, incorporated in, used as materials for, or mixed with other goods or materials prior to payment, the goods (but not the risk) in the whole of such other goods or materials shall pass to the Seller at the moment of such processing, incorporation, and shall remain with the Seller until all such monies are paid.
- g) Until full payment is made, the Buyer shall hold all goods and materials, the property in which is vested in the Seller by virtue of sub-Clauses and hereof upon trust for the Seller and if the Seller so requires, the Buyer shall store such goods and materials at no cost to the Seller, clearly identified as belonging to the Seller. If any payment is overdue the Seller shall be entitled (without prejudice to any of its other rights and remedies) to recover and resell any or all of such goods, or materials, or document of title thereto, and the Buyer hereby authorises the Seller to enter upon the Buyer's premises for that purpose.
- h) The Buyer has the right to sell in the ordinary course of his or their business for the account of the Seller any goods or materials the property in which is vested in the Seller virtue of this Clause. In such event the Seller shall be entitled, and the Buyer hereby expressly agrees, he or they shall be under a fiduciary duty, to account to the Seller for the proceeds of such sale, to the extent that any monies are owed by the Buyer to the Seller. In addition, the Seller shall be entitled to make a claim directly against the Buyer's client for any purchase monies unpaid by the client provided that the Seller shall return to the Buyer any monies recovered in excess of the amount then owed by the Buyer to the Seller, together with costs and expenses involved in making such claim.

## 5. NOTIFICATION OF CLAIMS

- a) If goods are dispatched by the Seller or Sellers appointed carrier any claims on account of damage to, or partial loss of goods in transit, must be made to the Seller, and notified to the carrier in writing three days after delivery.
- b) Claims for non-delivery must be advised within fourteen days from advice of dispatch.

## 6. TERMS OF PAYMENTS

All invoices shall become due for payment 30 days after date of invoice unless otherwise agreed in writing by the seller. In the event of any invoice remaining unpaid after that time, the Seller shall be entitled to recover interest upon the outstanding balance at the rate of 8% above the base lending rate of HSBC Bank Plc, in accordance to the Late Payment of Commercial Debts (Interest) Act 1998

## 7. WARRANTIES AND LIMITATIONS OF LIABILITY

- a) The Seller's goods are supplied without any warranty condition or guarantee expressed or implied that they are suitable for the use under any special conditions or for any particular purpose or as to the quality or suitability for any particular purpose, even though that purpose may have been known by the Seller.
- b) All warranties, conditions and statements expressed or implied, statutory or otherwise are excluded.
- c) The Seller's liability (if any) for direct loss or damage, other than death or personal injury, resulting to the Buyer from any defect in the goods, shall be limited to the purchase price of the goods in respect of which such loss or damage is claimed.
- d) The Seller under no circumstances accepts liability for any consequential loss, or damage arising in the connection with any goods, material's, or service's supplied by the Seller.
- e) All defective goods must be returned to the Seller, carriage paid, within a reasonable period from delivery.
- f) The Seller's do not accept any liability whatsoever for damage or loss arising, in the Seller's opinion, from incorrect or faulty installation, servicing, misuse, neglect, abnormal conditions of working, failure to store in proper conditions, or failure to observe the Seller's operating instructions.

## 8. PRICE VARIATION

Prices given in quotations when accepting orders, or at any time, are subject to variation and any orders accepted shall be subject to the express conditions that prices ruling at the time of dispatch or the order of any part thereof shall apply.

## 9. RETURNED GOODS

- a) Any goods supplied, to the special requirements of the Buyer, which is outside the Seller's normal range, as set out in its catalogue, the Buyer shall in no circumstances be entitled to return any such goods for credit.
- b) Goods can only be returned for credit with the Seller's prior approval. On approval the goods may be returned, but must be complete, in a resalable condition, in their original packaging, delivered carriage paid, with the risk of the goods passing from Buyer to Seller, at the Sellers warehouse. The goods returned, will be subject to a restocking fee of 30% of their original value (excluding carriage).

## 10. PROPER LAW AND ARBITRATION

These standard conditions of Sale shall be operated and be construed in conformity with the Laws of England. Any dispute arising thereunder shall be settled by arbitration in London in accordance with the provisions of the Arbitrations Act or any statutory modification thereof for the time being in force, each party appointing an arbitrator, unless a single arbitrator be agreed upon.

Which of the following best describes your industry/Business?

Audio/Visual	Marine	Architect	Distributor
Bathroom	Manufacturer OEM	Supplier	Installer
Hotel	Interiors	OEM	Re-Seller
Kitchen	Interior Designer	Other (please give details)	

Signed \_\_\_\_\_

Date \_\_\_\_\_

Name (printed) \_\_\_\_\_



Position \_\_\_\_\_

# Non UK Credit Acct Application



**Business Type:** Limited Company\_\_\_\_\_ Partnership\_\_\_\_\_ Sole Trader\_\_\_\_\_ Other\_\_\_\_\_

**Business Details:**

Company Name Trading As			
Registered Address			
Post Code		Company Reg No. (if applicable)	
VAT Number		Country of Trading	

**Trading Address if different:**

Address		
	Post Code	

**Accounts Address if different:**

Address		
	Post Code	

**Bank/Building Society Details:**

Name			
Address			
Postcode		Post Code	

**Company Contact Details:**

Department	Name	Telephone Number	Email
Purchasing			
Invoicing			
Payments			

**Showroom Contact Details:**

Showroom Contact		
Telephone Number		
Email Address of sales contact		

**Name and Address of Partner 1:**

Name			
Address			
Post Code		Email	

**Name and Address of Partner 2:**

Name			
Address			
Post Code		Email	

**For Office use only:**

Sage Ref	HSBC Ref	Date Approved	Credit Limit	Discount	REP	Displaying Outlet	Business Type



# CONDITIONS OF SALE

## 1. GENERAL

The following are the terms and conditions of Aquavision distribution Limited.

a) "Seller" means the party providing the goods or services under these terms and conditions.

b) "Buyer" means the party contracting with the Seller to acquire the good and/or services supplied under these terms and conditions.

c) "Goods" means all goods (by way of intermediate or finished product) and services supplied by the Seller to the Buyer.

d) "Insolvency" means the Buyer is in a position where it is unable to pay its debts, or has a winding up petition issued against it, or has a receiver, administrator or administrative receiver appointed to it, or being a person, commits an act of bankruptcy, or has a bankruptcy petition issued against him.

All quotations, contracts and orders are made and accepted only upon these conditions unless expressly varied in writing by the Seller; no modification, variation or amendment of these conditions by the Buyer, whether in writing or otherwise shall have any effect.

## 2. VALIDITY OF QUOTATION

Unless otherwise stated or previously withdrawn, every quotation is open for acceptance within thirty days only from its date, and, if required by the Seller, is subject to approval of the Buyer's credit. Acceptance is subject to goods being unsold at the date of receipt thereof.

## 3. CANCELLATION

a) The contract or order can only be cancelled by the Buyer, with the written consent of the Seller, which if given shall be deemed to be on the express condition that the Buyer shall indemnify the Seller against loss, damage, claim or actions arising out of such a cancellation, unless otherwise agreed in writing.

b) The Seller is relieved of its obligation hereunder wherever and to the extent to which fulfilment or delivery is prevented, frustrated or impeded as a consequence of any circumstances outside its control including without prejudice to the generality of this provision, strikes, lock outs, trade disputes, breakdown, accidents, hostilities, Acts of God, shortage of materials or labour or any cause beyond the Seller control, force majeure or legalisation, regulation or orders issued by any government or local authority.

c) In the event of the Buyer not having paid for any previous order or delivery in accordance with the Seller's settlement terms, the Seller may at its discretion, withhold delivery until payment has been received or cancel outstanding deliveries or orders.

d) In the event of the Buyer entering into insolvency, the Seller may at its discretion, cancel any further deliveries.

e) In the event of the Seller exercising its option under c) and/or d) this does not relieve the Buyer of any liability or obligation he had under this contract.

## 4. DELIVERY, TITLE & RISK

a) Any stated delivery date period or rate shall not be of the essence of the contract, but is given as a guide only and whilst the Seller will make every effort to adhere to proposed timescales, the Seller accepts no responsibility for loss or damage resulting from delay, howsoever arising.

b) If for any reason the Buyer is unable to accept delivery of the goods at the time when the goods are due and ready for delivery, the Seller shall, if its storage facilities permit, store the goods and the Buyer shall be liable to the Seller for the reasonable cost (including insurance) of its so doing. This provision shall be without prejudice to any other claim which the Seller may make in respect of the Buyer's failure to take delivery at the appropriate date.

c) Delivery in the United Kingdom is ex Works Carriage Charged. Unless orders exceed a certain value which may from time to time be decided by the Seller in which event method of carriage is at the Seller's option and any special requirement of the Buyer will be charged for. Goods exported, unless otherwise agreed, will take place F.O.B. ex the Seller works. All packaging, duties and associated costs will be charged to the Buyer.

d) The risk of the goods shall pass to the Buyer at the point of delivery specified in the order acknowledgement form.

e) Notwithstanding delivery and the passing of risk, the property in the goods shall remain in the Seller unit until the Buyer has paid all monies owed by it to the Seller under this or any other contract or otherwise.

f) If any of the goods supplied by the Seller are processed into, incorporated in, used as materials for, or mixed with other goods or materials prior to payment, the goods (but not the risk) in the whole of such other goods or materials shall pass to the Seller at the moment of such processing, incorporation, and shall remain with the Seller until all such monies are paid.

g) Until full payment is made, the Buyer shall hold all goods and materials, the property in which is vested in the Seller by virtue of sub-Clauses and hereof upon trust for the Seller and if the Seller so requires, the Buyer shall store such goods and materials at no cost to the Seller, clearly identified as belonging to the Seller. If any payment is overdue the Seller shall be entitled (without prejudice to any of its other rights and remedies) to recover and resell any or all of such goods, or materials, or document of title thereto, and the Buyer hereby authorises the Seller to enter upon the Buyer's premises for that purpose.

h) The Buyer has the right to sell in the ordinary course of his or their business for the account of the Seller any goods or materials the property in which is vested in the Seller by virtue of this Clause. In such event the Seller shall be entitled, and the Buyer hereby expressly agrees, he or they shall be under a fiduciary duty, to account to the Seller for the proceeds of such sale, to the extent that any monies are owed by the Buyer to the Seller. In addition, the Seller shall be entitled to make a claim directly against the Buyer's client for any purchase monies unpaid by the client provided that the Seller shall return to the Buyer any monies recovered in excess of the amount then owed by the Buyer to the Seller, together with costs and expenses involved in making such claim.

## 5. NOTIFICATION OF CLAIMS

a) If goods are dispatched by the Seller or Sellers appointed carrier any claims on account of damage to, or partial loss of goods in transit, must be made to the Seller, and notified to the carrier in writing three days after delivery.

b) Claims for non-delivery must be advised within fourteen days from advice of dispatch.

## 6. TERMS OF PAYMENTS

All invoices shall become due for payment 30 days after date of invoice unless otherwise agreed in writing by the seller. In the event of any invoice remaining unpaid after that time, the Seller shall be entitled to recover interest upon the outstanding balance at the rate of 8% above the base lending rate of HSBC Bank Plc, in accordance to the Late Payment of Commercial Debts (Interest) Act 1998

## 7. WARRANTIES AND LIMITATIONS OF LIABILITY

a) The Seller's goods are supplied without any warranty condition or guarantee expressed or implied that they are suitable for the use under any special conditions or for any particular purpose or as to the quality or suitability for any particular purpose, even though that purpose may have been known by the Seller.

b) All warranties, conditions and statements expressed or implied, statutory or otherwise are excluded.

c) The Seller's liability (if any) for direct loss or damage, other than death or personal injury, resulting to the Buyer from any defect in the goods, shall be limited to the purchase price of the goods in respect of which such loss or damage is claimed.

d) The Seller under no circumstances accepts liability for any consequential loss, or damage arising in the connection with any goods, material's, or service's supplied by the Seller.

e) All defective goods must be returned to the Seller, carriage paid, within a reasonable period from delivery.

f) The Seller's do not accept any liability whatsoever for damage or loss arising, in the Seller's opinion, from incorrect or faulty installation, servicing, misuse, neglect, abnormal conditions of working, failure to store in proper conditions, or failure to observe the Seller's operating instructions.

## 8. PRICE VARIATION

Prices given in quotations when accepting orders, or at any time, are subject to variation and any orders accepted shall be subject to the express conditions that prices ruling at the time of dispatch or the order of any part thereof shall apply.

## 9. RETURNED GOODS

a) Any goods supplied, to the special requirements of the Buyer, which is outside the Seller's normal range, as set out in its catalogue, the Buyer shall in no circumstances be entitled to return any such goods for credit.

b) Goods can only be returned for credit with the Seller's prior approval. On approval the goods may be returned, but must be complete, in a resalable condition, in their original packaging, delivered carriage paid, with the risk of the goods passing from Buyer to Seller, at the Seller's warehouse. The goods returned, will be subject to a restocking fee of 30% of their original value (excluding carriage).

## 10. PROPER LAW AND ARBITRATION

These standard conditions of Sale shall be operated and be construed in conformity with the Laws of England. Any dispute arising thereunder shall be settled by arbitration in London in accordance with the provisions of the Arbitrations Act or any statutory modification thereof for the time being in force, each party appointing an arbitrator, unless a single arbitrator be agreed upon.

Which of the following best describes your industry/Business?

Audio/Visual		Marine		Architect		Distributor	
Bathroom		Manufacturer OEM		Supplier		Installer	
Hotel		Interiors		OEM		Re-Seller	
Kitchen		Interior Designer		Other (please give details)			

Signed \_\_\_\_\_

Date \_\_\_\_\_

Name (printed) \_\_\_\_\_



Position \_\_\_\_\_



[www.aquavision.tv](http://www.aquavision.tv)

**UK Head Office and Factory**

Aquavision  
Unit 2, Grosvenor Business Park, Horsfield Way  
Stockport, Cheshire, SK6 2SU  
Enquiries: [sales@aquavision.tv](mailto:sales@aquavision.tv)  
Telephone: +44 (0)161 711 1900

**US Office**

Aquavision Inc  
#197, 5 Southside Drive, Suite 11,  
Clifton Park, NY 12065  
Enquiries: [sales@aquavision.us](mailto:sales@aquavision.us)  
Telephone: +1 800 524 1804