

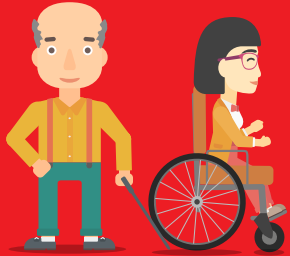

PRODUCT CATALOGUE 2019

AKW[®]

ONE



ONE SUPPLIER

You can now buy everything you need to complete your installation from AKW, saving you time and money – no need to drive to multiple suppliers – as well as reduced administration

ONE Delivery

Dedicated Nationwide transport including next day delivery options.

ONE Design

National Surveying Service – makes specifying and ordering easier

ONE Price

No additional costs to customer (time, fuel, and vehicle wear & tear)

ONE Stock

Large stockholding with recent warehouse extension for increased capacity

ONE Install

One delivery equals time saved. You could be completing 4 extra installs every year!



Number **ONE** for Technical After Sales Support

Number **ONE** for Lifetime Guarantees

Number **ONE** for Service

Number **ONE** for Surveyors & Maintenance Engineers

Number **ONE** for Maintaining Individuals Independence

Number **ONE** for Accessible Kitchens

Number **ONE** for Bathroom Adaptations

Number **ONE** for Product Development

Contents

INTRODUCTION

8

About AKW	8
How this book works	10
Placing an order	12
Surveys and delivery	14
Help & Support	16



WET ROOMS

19

Wet Room Formers	20
Wastes	30
Tanking Kits & Accessories	42



TRAYS AND SHOWERING

47

Shower Trays	48
Shower Screens & Enclosures	78
Wastes & Pumps	170
Showers	180



WALLS AND FLOORS

193

Tiles and Accessories	194
Timber	198
Safety Flooring	200
Wall Panels	204



MOBILITY SUPPORT

209

Grab Rails	210
Shower Seats	226
Doc M	246
Mobility Ramps	256



WASHROOM PRODUCTS

261

Sanitaryware	262
Brassware	282
Safety Heating	286
Bathroom Lights	291
Extractor Fans	295



BATHROOM FURNITURE

297

Furniture	298
Basin, WC & Base Units	299
Countertops	303
Integrated Sanitaryware	304
Accessories	305



PLUMBING FITTINGS

307

Compression Fittings	309
End Feed	310
Flexi Hoses/Pan Connectors/Isolating Valves	312
Push Fit	314
Solvent Weld	317



KITCHENS

321

ActivMotion® Rise & Fall Units	322
Independence Kitchen	326
Liberty Kitchen	344
Kitchen Options	354



SUPPORT

369

Installation & Product Guides	370
Useful Information	388
Product Index	389
Visit AKW	393
General Information	394



Quick Page Finder

Heating
286

Showers
180

Tiles & Accessories
194

Bathroom Lights
291

Timber
198

Shower screens
78

Grab rails
210

Brassware
282

Doc M
246

Fold-up Rails
222

Shower seats
226

Wash basins
277

Pumps
176

Plumbing Fittings
307

Wet room formers
20

Underfloor heating
288

Showers trays
48

Wet room wastes
30

Showers wastes
170

Safety Flooring
200

Toilets
263



About AKW

From a small Worcestershire business, AKW has grown to become the UK's market-leader and an international operation with:

- + 1 million+ satisfied customers
- + 250+ trained staff
- + World-class manufacturing facilities
- + Dedicated 40+ vehicle fleet providing door to door service
- + Two national distribution warehouses covering 100,000 sq. feet
- + 60+ sales and surveying experts nationwide

Choice, competitive pricing and first-class customer service make AKW the brand of choice for clients across the UK and abroad.

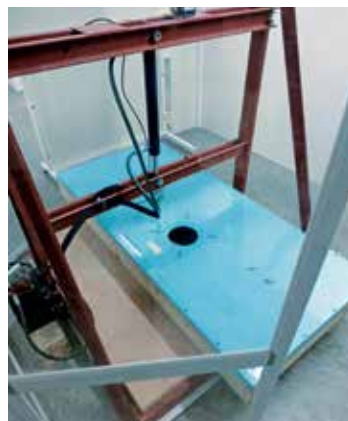

Life Made Better



'Made Better' is a phrase that runs through everything we do at AKW.

It's in finding ways to make someone's quality of life better through independent living solutions or improving our already exceptional levels of Customer Service.

It's in the superior quality and reliability of our products, many of which have a 'Made for life' warranty that we're constantly striving to make even better.

It's in making sure that all our deliveries arrive in full and on time and improving on the most extensive product range in the UK to make your life easier as a specifier, installer or customer.

...and no matter how hard we push ourselves, we keep pushing, because we believe things can always be 'Made Better'.



Placing an order

Ordering is easy. You can order online, by phone, fax or by emailing us.

Our friendly Customer Service team are here to help and can be contacted **Monday to Friday, from 8am to 5pm.**

@ orders@akw-ltd.co.uk

orders.akw-ltd.co.uk

01905 823 299

01905 823 297

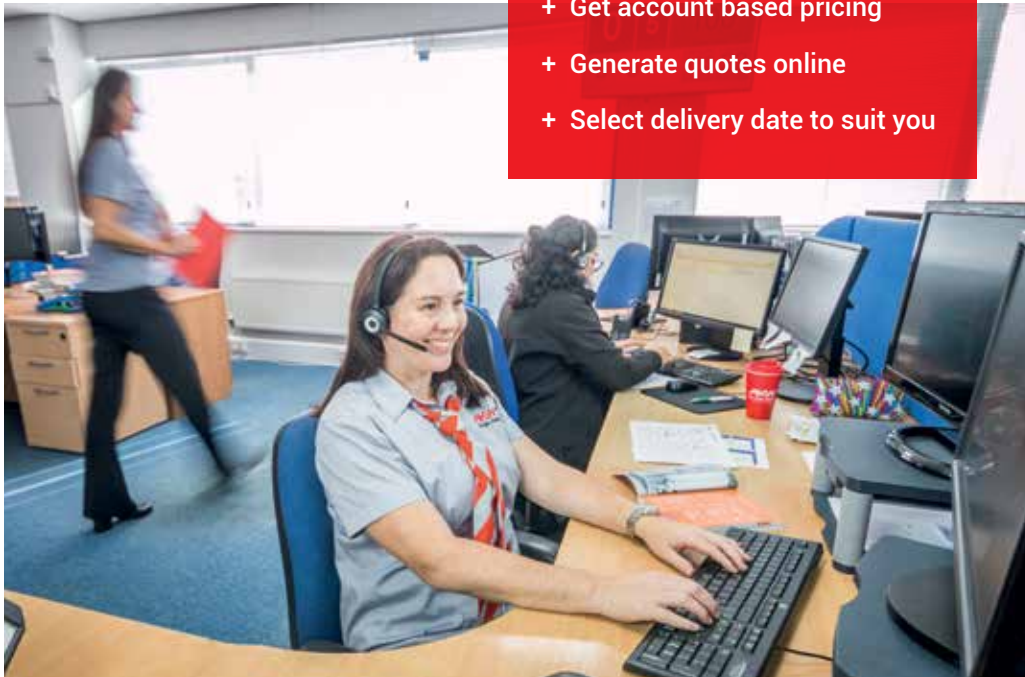

ORDERING ONLINE

orders.akw-ltd.co.uk



- + Available 24/7 via computer, tablet or smartphone
- + Get account based pricing
- + Generate quotes online
- + Select delivery date to suit you

Customer Service

Our Customer Service Centre is made up of 24 members of staff who are our first point of contact for all customers. They manage on average 600 calls, 450 orders and 150 quotations per day. Their average call wait time is just 12 seconds and we currently have a 98% service level meaning less than 2% of calls are dropped.

We also have a **Technical Helpline** on 01905 560 219 – to answer any questions about our products/ installation you may have, before or after purchase.

TRADE COUNTER



You can collect your order the same day from our trade counter with **AKW's free click and collect service.**

Open Monday to Friday, from 8am to 5.30pm (last orders 4pm).

Independence House, Pointon Way, Hampton Lovett, Droitwich Spa, WR9 0LW

AKW'S SPECIALIST KITCHEN TEAM

For enquires relating to AKW Independence and Liberty kitchens, get in touch with our specialist kitchen team. We also offer a **free kitchen survey** service to OTs and Local Authorities.

01905 823 262
kitchens@akw-ltd.co.uk



Surveying Excellence

At the heart of every successful project is careful planning, which is why AKW's specialist Survey Team covers the whole of the United Kingdom to complete over 6,400 surveys per year.

Naturally we put safety and security first, so all our surveyors carry AKW ID cards with Braille stickers for visually impaired customers. In addition they are all fully disclosure checked and they all wear AKW branded work wear to clearly identify them as AKW employees whilst attending the properties of potentially vulnerable people.

Our thorough surveys provide complete peace of mind that the products and installation methods we specify will meet the client's needs, fit first time and give trouble-free use for many years to come.

Please email CSS@akw-ltd.co.uk to arrange a survey.



Our simple three stage survey process:

1 Within 10 working days of receiving instruction, an experienced AKW surveyor will undertake a site survey and take all necessary measurements.

2 Our designs will be based on healthcare professional reports and tenants' specific needs to ensure we fully understand what is required and that we can provide the right technical advice.

3 Within 5 working days, we'll provide a 2D plan view (or 3D for kitchens) computer-aided drawing of how the new kitchen or bathroom will look.

Delivery

We operate a dedicated fleet of over 40 delivery vehicles nationwide because we believe no one will take as much care to deliver your order on time as we will.

In 2017 we made 99,696 deliveries over 2.4 million delivery miles with 99.86% delivered on time.



AKW offer a non-stop service, delivering products direct from its warehouse to the customer with no in-transit handling. In fact, we are the only manufacturer in our sector that only use dedicated transport and do not use carriers.

Live tracking of every item shipped and each vehicle ensures that your order will be delivered exactly when you expect it and in perfect condition. We have shrunk packaging use by 70% and reduced delivery time.

Because we always go the extra mile for our customers, over 95% say they would recommend us.



General Enquiries:

01905 823 298

www.akw-ltd.co.uk

Technical Enquiries:

01905 560 219

technicalenquiries@akw-ltd.co.uk



Here to help

The best help comes from people who really understand your needs, no matter how big or small it may be.

You want your items delivered on time, which is why we run our dedicated fleet of over 40 delivery vehicles nationwide, because no one takes as much care as us.

You want advice from people who've been in the same spot you're in, so our Technical Support team is staffed by installers with decades of experience, from 8am to 5pm every weekday.

If our customers are happy, we're happy.

Regulation & Compliance

AKW is committed to ensuring our products comply with all mandatory legislation, and many have also been tested to voluntary standards.



For any product carrying the **CE Mark**, we can supply a copy of the relevant Declaration of Performance (CPR) or Conformity (MDD).



BEAB Approval is used by electrical manufacturers to support CE Marking & demonstrate conformity with Low Voltage Directive (LVD).



Products that carry the **BEAB Care Mark** comply with additional safety/performance criteria for use in hospitals & other care establishments.



WRAS Approval demonstrates that a product won't cause waste, misuse, undue consumption or contamination of the water supply.



ISO 9001: International Standard for Quality Management Systems. **ISO 14001:** International Standard for Environmental Management Systems.



The **RNIB Mark** identifies products that are easy to use if you're blind or partially sighted.



The **BHTA** is the UK's oldest & largest healthcare association with a Code of Practice that ensures customers receive high levels of service.



Products carrying the **EMC Mark** have been approved through Electromagnetic Compatibility (EMC) Testing from Intertek.



AKW is an approved supplier of the **Association of Plumbing & Heating Contractors**.



AKW is a member of the **Bathroom Manufacturers Association (BMA)**.



All of our **Thermostatic Mixing Valves (TMVs)** meet the requirements for either the TMV2 (domestic sector) or TMV3 (healthcare sector) scheme.



The **European Water Label** aims to reduce water consumption by identifying the water consumption of relevant products.

Wet Rooms

WET ROOM FORMERS

20

Tuff Form® Former	21
TriForm® Former	26

WASTES

30

Gravity Wastes	31
Dry Wastes	35
Pumped Wastes	38
Waste Adaptors	40

TANKING KITS & ACCESSORIES

42

Mapei Tanking Kits	43
FormSafe® Kit	44
Threshold Kits	45

Wet Rooms Installation Guides:
See page 380

Screeded Floor Installation Guides:
See page 385

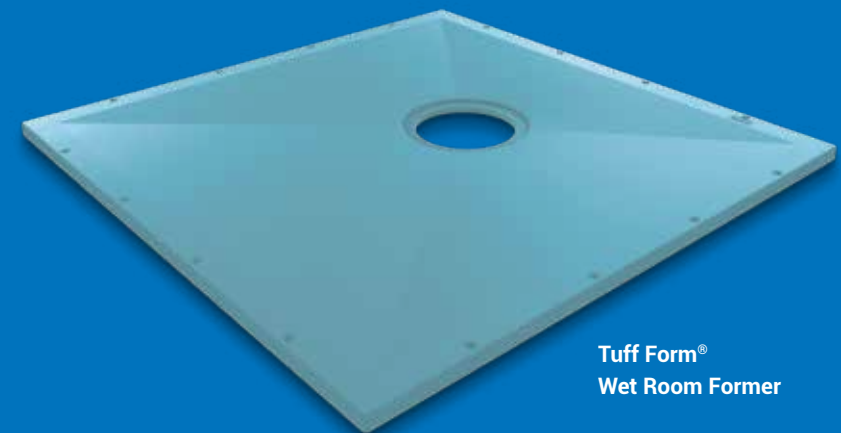

Tuff Form®
Wet Room Former



Wet Room Formers

Wet rooms are the ultimate solution in practical living for all users in a household.

Not only do they create complete level access, they are also 100% watertight.

A wet room allows you to maximise the available space in your bathroom to create a stylish but practical showering solution.

You may also need:

Wastes 30 >	Shower Screens 78 >
Tanking Kits 42 >	Showers 180 >
Safety Flooring 200 >	Timber 198 >

Shower Screen type (with tray compatibility reference code):

- Standard Shower Screens
- Glass Shower Screens
- Sliding Shower Screens
- Silverdale Shower Screens



WET ROOM FORMERS

TuffForm®

Tuff Form® Wet Room Former

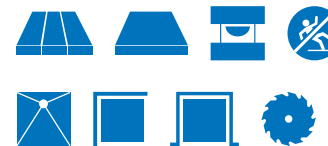

For guide to icons, see [page 11](#)

Helping you create wet floor shower areas and multi-user bathrooms, Tuff Form® makes excellent use of available space.

BENEFITS

- + Creates a full level access showering solution
- + Easily trimmed on site to enable fast and simple installation
- + Exceptionally strong to accommodate a user with wheelchair and a carer too (up to 60 stone/381kg bearing weight)
- + Tens of thousands of installations worldwide, so it's popular – and proven!
- + Screen sets fold back to free up floor space – ideal for wheelchair access
- + A variety of screen sizes and styles give you added choice
- + A wet floor installation with suitable slip resistant flooring provides excellent water integrity with comfort and safety underfoot
- + Fully recyclable
- + Superior strength and rigidity, ideal for fitting under the bath in multi-tenant dwellings

FEATURES

- + Suitable for both wooden and solid floors
- + Formed from compressed GRP which allows the Tuff Form® to be cut to length or trimmed to within 150mm of the waste without losing any strength integrity
- + The ribbed design of the underside eliminates slippage or float during installation
- + Offset waste position to avoid joists or pipework
- + Tuff Form® depth is 22mm
- + Pre-formed fixing holes



Tuff Form® (Size Options, Product Codes & Dimensions)

Tuff Form® Wet Room Former – 900 x 900mm

Former only	21000
Former with TF75 Waste	21002
Former with GW50 waste and waste adaptor	21060
Former with low depth GW90 waste & adaptor	21089

Compatible shower screens:

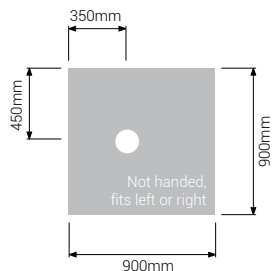

Tuff Form® Wet Room Former – 1000 x 1000mm

Former only	21008
Former with TF75 Waste	21006
Former with GW50 waste and waste adaptor	21061
Former with low depth GW90 waste & adaptor	21090

Compatible shower screens:

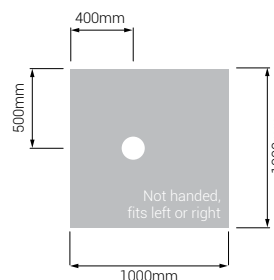

Tuff Form® Wet Room Former – 1135 x 770mm

Former only	21012
Former with TF75 Waste	21014
Former with GW50 waste and waste adaptor	21062
Former with low depth GW90 waste & adaptor	21091

Compatible shower screens:

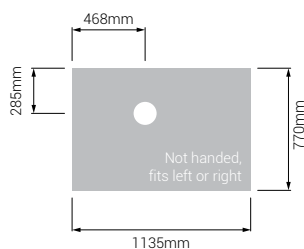

See **Waste Options** starting on page 30

Tuff Form® (Size Options, Product Codes & Dimensions)

Tuff Form® Wet Room Former – 1200 x 1200mm

Former only	21018
Former with TF75 Waste	21020
Former with GW50 waste and waste adaptor	21065
Former with low depth GW90 waste & adaptor	21095

Compatible shower screens:

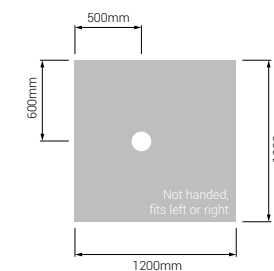

Tuff Form® Wet Room Former – 1300 x 820mm

Former only	21027
Former with TF75 Waste	21029
Former with GW50 waste and waste adaptor	21063
Former with low depth GW90 waste & adaptor	21092

Compatible shower screens:

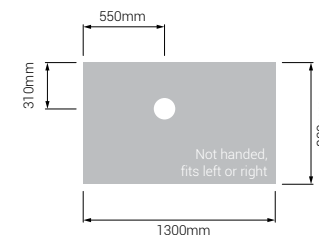

Tuff Form® Wet Room Former – 1400 x 900mm

Former only	21028
Former with TF75 Waste	21030
Former with GW50 waste and waste adaptor	21070
Former with low depth GW90 waste & adaptor	21094

Compatible shower screens:

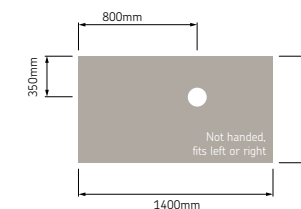

See **Compatible shower screens** starting on page 78

Tuff Form® (Size Options, Product Codes & Dimensions)

Tuff Form® Wet Room Former – 1500 x 820mm

Former only	21036
Former with TF75 Waste	21038
Former with GW50 waste and waste adaptor	21064
Former with low depth GW90 waste & adaptor	21093

Compatible shower screens:

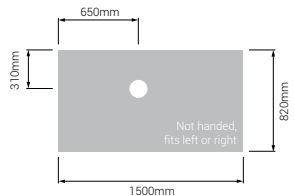

Tuff Form® Wet Room Former – 1500 x 1200mm

Former only	21045
Former with TF75 Waste	21046
Former with GW50 waste and waste adaptor	21067
Former with low depth GW90 waste & adaptor	21096

Compatible shower screens:

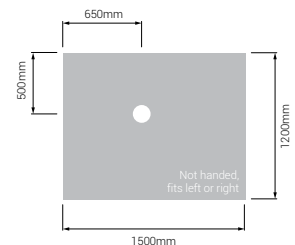

Tuff Form® Wet Room Former – 1800 x 820mm

Former only	21050
Former with TF75 Waste	21052
Former with GW50 waste and waste adaptor	21066
Former with low depth GW90 waste & adaptor	21097

Compatible shower screens:

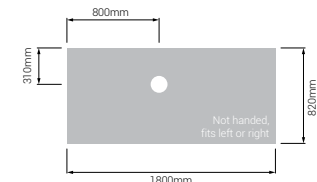

Hand-Made Tuff Form® Wet Room Former – 1200 x 900mm

Former only	21015
Former with TF75 Waste	21021
Former with GW50 waste and waste adaptor	21023
Former with low depth GW90 waste & adaptor	



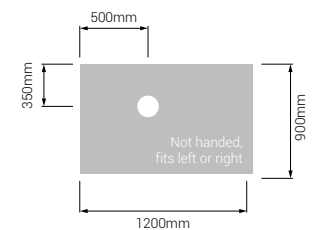





Compatible shower screens:



See **Compatible shower screens** starting on page 78

Tuff Form® : Optional Extras

Tuff Form® Waste Options

	TF75 Gravity waste 25106 For details see page 34		SS-TF75 Stainless Steel Gravity Waste LB00101 For details see page 34
	DW90 Low Depth Dry Shower Waste – with Tuff Form® Tiled Floor Adaptor 25418-UK For details see page 35		DW90 Low Depth Dry Shower Waste – with Tuff Form® Vinyl Floor Adaptor 25419-UK For details see page 36
	GW90-2 Low Height Wet Waste with Vinyl Floor Adaptor 25499-UK For details see page 33		GW90-2 Low Height Wet Waste with TF Tiled Floor Adaptor 254198-UK For details see page 32
	Screedmaster® Pumped Gully 15mm 25100 22mm 25407 For details see page 39		SilentFlow+® Waste Pump (PGTF) with 22mm Outlet 25414 For details see page 39

Tuff Form® Pipe Duct Kit

Pipe Duct Kits fit on to the edge of the tray to avoid the re-routing of existing pipework.

FEATURES

- + Fully waterproof mouldings
- + Quick installation
- + Substantial savings on time and labour costs
- + Requires Extra Wide Compensator (see page 167)

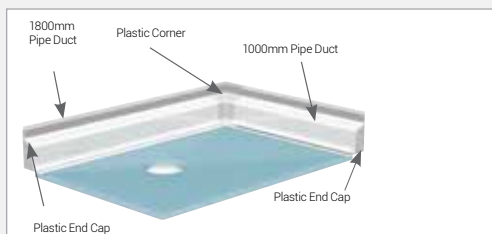

Product Codes:

Kit 1	
1 x 1800mm pipe duct +	
2 x Plastic end caps	21105
Tiling cover extrusion	07220
Kit 2	
1 x 1000mm pipe duct +	
2 x Plastic end caps	21106
Screw slot infill	07221
Kit 3	
1 x Plastic corner moulding	21107

TriForm® Wet Room Former



TriForm® performs superbly and looks even better to create a truly aspirational yet functional showering experience. Offering perfectly level access, TriForm® can be used with a wide range of tiles and finishes.

BENEFITS

- + Reversible two-in-one cover offers a choice of two different finishes
- + Three easy fit waste positions deliver superior flow capacity
- + Exceptional drainage, capable of handling a flow rate of up to 78 litres of water per minute with all three wastes fitted
- + Greater weight bearing capacity of up to 254kg

FEATURES

- + Easily trimmed to size to within 100mm of the waste
- + Can accommodate tiles up to 250mm thick
- + Numerous waste positions available to easily avoid joists
- + Drill guides included
- + Self supporting and suitable for ground floor and upstairs bathrooms



For guide to icons, see page 11



TriForm® (Size Options, Product Codes & Dimensions)

TriForm® Wet Room Former – 900 x 900mm

Former only code: **21205**

Compatible shower screens:

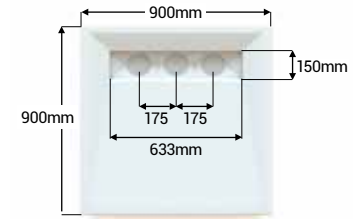

TriForm® Wet Room Former – 1000 x 1000mm

Former only code: **21206**

Compatible shower screens:

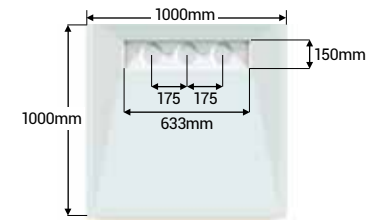

TriForm® Wet Room Former – 1200 x 900mm

Former only code: **21209**

Compatible shower screens:

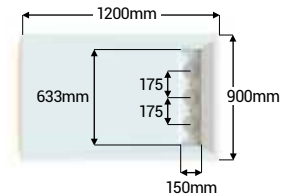

TriForm® Wet Room Former – 1200 x 1200mm

Former only code: **21208**

Compatible shower screens:

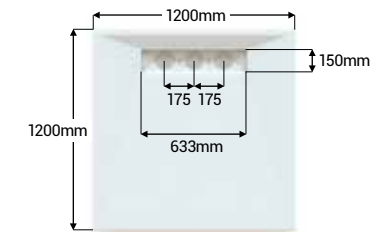

TriForm® Wet Room Former – 1300 x 820mm

Former only code: **21207**

Compatible shower screens:

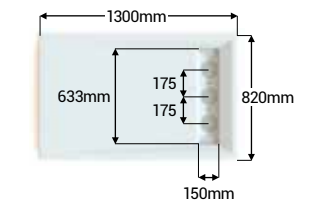

See **Compatible shower screens** starting on page 78

TriForm® Gully Waste



Gully Waste drain kit and cover options for use with any TriForm® wet floor former.

FEATURES

- + Two cover options: a two-in-one option (stainless steel on one side, a tiling option on reverse) and a one-sided decorative stainless steel slotted cover
- + Suitable to use with tiles ranging from 6-25mm

Product Codes:

TriForm® Stainless Steel/Reverse-to-Tile Gully Waste Kit (to suit 6-16mm thick tiles)	21213
TriForm® Stainless Steel/Reverse-to-Tile Gully Waste Kit (to suit 16-25mm thick tiles)	21214
TriForm® Decorative Stainless Steel Slotted Gully Waste Kit (to suit 6-16mm thick tiles)	21215
TriForm® Decorative Stainless Steel Slotted Gully Waste Kit (to suit 16-25mm thick tiles)	21216

TriForm® Waste Options



DW90 Low Depth Dry Waste (Domed Cover) **25492-UK**
For details see [page 37](#)



GW19 19mm Gravity Waste **25125**
For details see [page 31](#)



GW90 Gravity Waste **25120**
For details see [page 31](#)



GW50 Gravity Waste **25126**
For details see [page 31](#)



Low Depth GW90 **25404**
For details see [page 32](#)

Wastes

AKW's extensive range of wastes complement our range of wet room formers and shower trays. The range includes gravity, dry and pumped wastes to cover all installations.



You may also need:

Wet Room Formers 20 >	Shower Screens 78 >
Tanking Kits 42 >	Showers 180 >
Safety Flooring 200 >	Timber 198 >



GRAVITY WASTES

Standard Gravity Waste with 19mm or 50mm Water Trap



Exploded View

GW50 Patent: GB2418355

AKW Standard gravity waste with 19mm or 50mm water trap for Braddan trays or the Tuff Form® former with adaptor (see page 40).

FEATURES

- + Good seals and location
- + Built in filter
- + 19mm or 50mm water trap depth (seal)
- + 50mm threaded waste fitting
- + Depth below tray: 93mm (19mm) & 124mm (50mm)
- + Overall depth: 113mm (19mm) & 144mm (50mm)

Product Codes:

Standard Gravity Waste (19mm Water Trap) **25125**

Standard Gravity Waste (50mm Water Trap) **25126**

GW90 90mm Diameter Gravity Waste with 50mm Water Trap



Exploded View

GW90 Patent: GB2418355

Can be specified with any Mullen® or Low Profile tray. Alternatively can be fitted to the Tuff Form® former with adaptor (see page 40).

FEATURES

- + Built in filter
- + Top access for easy cleaning and rodding
- + 50mm water trap depth (seal)
- + 90mm diameter threaded waste fitting
- + Depth below tray: 90mm
- + Overall depth: 110mm

Product Code:

GW90 Gravity Waste (50mm Water Trap) **25120**

Low Depth GW90 90mm Diameter Gravity Waste with 50mm Water Trap



The low depth gravity waste has been designed for ease of installation and flexibility of fitting. The 90mm diameter waste with a 50mm water trap is suitable for Sulby 2, Low Profile and Mullen® trays where height restrictions are an issue. Alternatively it can be used with the Tuff Form® former with GW90 Gravity waste adaptor (see page 40).

FEATURES

- + Unique swivel outlet for quick and easy installation
- + 50mm water trap depth (seal)
- + Top access for easy cleaning and rodding
- + Built in filter
- + Approximate flow rate 10 litres per minute
- + Depth below tray: 60mm
- + Overall depth: 82mm

Product Code:

Low Depth GW90 Gravity Waste (50mm Water Trap) **25404**

GW90-2 Low Depth Wet Waste with TF Tiled Floor Adaptor



FEATURES

- + Shallow 53mm depth. Useful for solid floor or shallow joists.
- + Very compact
- + Good seals and location
- + 50mm water trap preventing bad odour backflow
- + Suitable for push fit pipe (with included adaptor)
- + Suitable for solvent weld pipe (w/included adaptor)
- + Top access for easy cleaning and rodding
- + High flow rate (27 l/min +15mm head + 1m pipe)

GW90-2 Low Depth Wet Waste with TF Tiled Floor Adaptor **25498-UK**

GW90-2 Low Depth Wet Waste with Vinyl Floor Adaptor



FEATURES

- + Shallow 53mm depth. Useful for solid floors or shallow joists.
- + Very compact
- + Good seals and location
- + Suitable for push fit pipe (with included adaptor)
- + Suitable for solvent weld pipe (with included adaptor)
- + Top access for easy cleaning and rodding
- + High flow rate (27 l/min with 15mm head and 1m of pipe)
- + Meets the performance requirements of British standards

GW90-2 Low Depth Wet Waste with Vinyl Floor Adaptor

25499-UK

TF75 Bottom Outlet Waste with 75mm Water Seal Trap Shower Gully

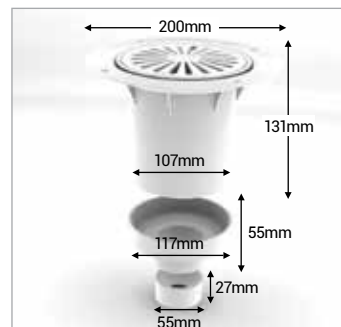

TF75 Patent: GB2402946

Can be specified with vinyl floor covering.

FEATURES

- + Beyonet fitting or option to screw down waste top
- + Ideal for properties with concrete flooring
- + Suitable to fit with Tuff Form® wet floor formers
- + 75mm water seal trapped waste for wet floors with Ø110mm vertical outlet and Ø110mm 0 x 2 inch BS5255 solvent weld reducer
- + Solvent socket adaptor for vertical 4", 2", 1½" outlets

TF75 Bottom Outlet Waste with 75mm Water Seal Trap Shower Gully

25408

TF75 Gravity Waste for Tuff Form® & Screeded Floors



TF75 Patent: GB2402946

Can be specified with any Tuff Form® wet floor former and for any screeded floor installation in a breachable floor.

FEATURES

- + Suitable for vinyl floors
- + Beyonet fitting or option to screw down waste top
- + Top access for easy cleaning and rodding
- + Adjustable elbow for waste pipe exit
- + Depth below tray: 125mm
- + Overall depth: 132mm
- + Water Trap depth (seal): 75mm

TF75 Gravity Waste for Tuff Form® & Screeded Floors

25106



Exploded View

SS-TF75 Stainless Steel Gravity Waste for Tuff Form® & Screeded Floors



Patent Pending

Can be specified with any Tuff Form® wet floor former and for any screeded floor installation in a breachable floor.

FEATURES

- + Suitable for tiled floors
- + Top access for easy cleaning and rodding
- + Adjustable elbow for waste pipe exit
- + Stainless steel plate dimensions: 120 x 120mm
- + Stainless steel plate height is adjustable to max of 25mm
- + Depth below tray: 125mm
- + Overall depth: 132mm
- + Water Trap depth (seal): 75mm

SS-TF75 Stainless Steel Gravity Waste for Tuff Form® & Screeded Floors

LB00101

DRY WASTES

DW90 Waste with Tuff Form® Tiled Floor Adaptor



Tuff Form® Waste for Tiled Flooring with DW90 Low Depth Dry Shower Waste and Tiled Floor Adaptor.

FEATURES

- + Very compact
- + Shallow 53mm depth. Useful for solid floors or shallow joists.
- + Suitable for use on tiled floors
- + Non return valve preventing bad odour backflow
- + Trap will not dry out with sporadic use
- + Universal pipe fitment
- + Suitable for push fit pipe (with included adaptor)
- + Suitable for solvent weld pipe (with included adaptor)
- + Top access for easy cleaning
- + High flow rate (27 l/min with 15mm head and 1m of pipe)
- + Meets the performance requirements of British standards, BS EN 274 Part 2:2002
- + Spare parts available: Pipe Adaptor Kit and Dry Waste Non Return Valve

Product Codes:

DW90 Low Depth Dry Shower Waste with Tuff Form® Tiled Floor Adaptor	25418-UK
Spare Pipe Adaptor Kit	16-006-058
Spare Dry Waste Non Return Valve	16-006-037



Spare Parts:



Spare Pipe Adaptor Kit



Spare Dry Non Return Waste Valve

DW90 Waste with Tuff Form® Vinyl Floor Adaptor



Tuff Form® Waste for Vinyl Flooring with DW90 Low Depth Dry Shower Waste and Vinyl Floor Adaptor.

FEATURES

- + Very compact
- + Shallow 53mm depth. Useful for solid floors or shallow joists.
- + Suitable for use on vinyl floors
- + Non return valve preventing bad odour backflow
- + Trap will not dry out with sporadic use
- + Universal pipe fitment
- + Good seals and location
- + Suitable for push fit pipe (with included adaptor)
- + Suitable for solvent weld pipe (with included adaptor)
- + Top access for easy cleaning
- + High flow rate (27 l/min with 15mm head and 1m of pipe)
- + Meets the performance requirements of British standards, BS EN 274 Part 2:2002



Spare Parts:



Spare Pipe Adaptor Kit



Spare Dry Waste Non Return Valve

Product Codes:

DW90 Low Depth Dry Shower Waste with Tuff Form® Vinyl Floor Adaptor	25419-UK
Spare Pipe Adaptor Kit	16-006-058
Spare Dry Waste Non Return Valve	16-006-037

DW90 Low Depth Dry Waste (Domed Cover)



British Standards BS EN 274 Part 2:2002

Low Depth Dry Waste for trays requiring Ø 90 wastes.

FEATURES

- + Shallow 48mm depth
- + 90mm diameter:
- + Universal pipe fitment
- + Suitable for push fit pipe (with included adaptor)

Product Code: **25492-UK**

PUMPED WASTES

PGTF Pumped Gulley Waste for Tuff Form® with 15mm Outlet only



Patent: GB2373515

Can be specified with Tuff Form® former (with vinyl).

FEATURES

- + Opens for easy cleaning and rodding
- + Depth below tray: 35mm, Overall depth: 43mm
- + 15mm John Guest Speedfit outlet

Product Code: **25101**

SS-PGTF Stainless Steel Pumped Gulley Waste for Tuff Form® with 22mm Outlet only



Can be specified with Tuff Form® former (with tiles).

FEATURES

- + Opens for easy cleaning and rodding
- + Depth below tray: 44mm, Overall depth: 52mm
- + 22mm John Guest Speedfit outlet
- + Stainless steel plate dimensions: 120 x 120mm
- + Stainless steel plate height adjustable 25mm (max)

Product Code: **LB00104**

For 15mm please order a reducer – code: **25195**

Screedmaster® Pumped Gulley



Patent: GB2374876

Fit a pumped waste into a floor screed without having to excavate the entire floor.

FEATURES

- + Enables quick and hassle free installation
- + Strong enough to cope with wheelchairs/chair legs
- + Use with graded floor installations (with vinyl floor)
- + Opens for easy cleaning and rodding
- + 15 or 22mm JG Speedfit® outlet (32 or 37mm deep)
- + Can Be specified with Tuff Form (with vinyl flooring)

Product Codes:

15mm Screedmaster® Pumped Gulley	25100
22mm Screedmaster® Pumped Gulley	25407

SilentFlow+® Waste Pump (PGTF) with 22mm Outlet



The SilentFlow+® waste pump is a completely new design which is virtually silent in operation to reduce the noise associated with shower pumps and wastes.

FEATURES

- + Noise level testing shows the SilentFlow+® is comparable with the nearest competitors 'quiet' pumped waste at up to 11LPM and outperforms above 11LPM
- + Can be connected to all pumps in the current range
- + Integrated 22mm John Guest fitting
- + Can Be specified with Tuff Form (with vinyl flooring)

Product Code:

SilentFlow+® Waste Pump (PGTF) (22mm John Guest Speedfit Outlet)	25414
---	--------------

WASTE ADAPTORS

TFWA Tuff Form® Waste Adaptor



This adaptor ring allows a typical top clearing ø50mm trapped waste to be fitted into a Tuff Form® wet floor former.

FEATURES

- + Opens from above for easy installation
- + 19mm (GW19) or 50mm (GW50) water trap options available
- + Depth below tray: 97mm (19mm) & 128mm (50mm)
- + Overall depth: 128mm (19mm) & 159mm (50mm)
- + Can Be specified with Tuff Form (with vinyl flooring)

Product Codes:

TFWA Tuff Form® Waste Adaptor only	25107
TFWA Tuff Form® Waste Adaptor with 19mm Standard Waste	25129
TFWA Tuff Form® Waste Adaptor with 50mm Standard Waste	25124

Patent: GB2402946

EU reg number: EU 000189105-0001



Please note: Supplied with bayonet fitted cover. Has the option of additional securing with screws as shown in photo.

GW90 Gravity Waste Tuff Form® Adaptor



The GW90 Gravity Wastes (25404 & 25120) are suitable for use with the Tuff Form® tray if fitted in conjunction with this Tuff Form® waste adaptor for vinyl flooring.

GW90 Gravity Waste Tuff Form® Adaptor	25409
---------------------------------------	--------------

For the GW90 Gravity waste see page 31.

SS-TFWA Stainless Steel Tuff Form® Waste Adaptor



This adaptor ring allows a typical top clearing ø50mm trapped waste to be fitted into a Tuff Form® wet floor former.

FEATURES

- + Opens from above for easy installation
- + 19mm (GW19) or 50mm (GW50) water trap options available
- + Stainless steel plate dimensions: 120 x 120mm
- + Stainless steel plate height is adjustable to max of 25mm
- + Depth below tray: 97mm (19mm) & 128mm (50mm)
- + Overall depth: 128mm (19mm) & 159mm (50mm)

Product Codes:

SS-TFWA Tuff Form® Waste Adaptor only	LB00171
SS-TFWA Tuff Form® Waste Adaptor with 19mm Standard Waste	LB00103
SS-TFWA Tuff Form® Waste Adaptor with 50mm Standard Waste	LB00102



EU reg number: EU 000189105-0001

TF75 Tuff Form® Bath-to-Tray Adaptor



The TF75 Bath-to-Tray Adaptor, used in conjunction with the TF75 Tuff Form® Gravity Waste (see page 31), has been designed to offer customers a Bathroom for Life.

TF75 Tuff Form® Bath-to-Tray Adaptor	25410
--------------------------------------	--------------

Tanking Kits

Our tanking kits make your wet room 100% watertight.

The range of options include fast drying flexible liquid tanking membranes to a pre-formed rubberised membrane system which is ready to tile immediately.



TANKING KITS & ACCESSORIES

MAPEI provide a comprehensive range of products to be used alongside AKW products in the construction of domestic wet rooms.

MAPEI Wet Room Tanking Kit



Materials

Kit includes: 1x 10kg drum of Mapegum WPS (5m² coverage), 10 metres of Mapeband Tape (120mm wide), 4x Mapeband Internal Corners, 1x Mapeband Waste Outlet Gasket (400 x 400mm) and 1x Mapeband Pipe Inlet Kit.

Product Codes:

MAPEI Wet Room Tanking Kit	LB00113
Mapegum WPS (5kg/10kg/25kg)	LB00115/ LB00114/ LB00121
Mapeband Tape (10m x 120mm wide)	LB00118
Mapeband Internal Corners x2	LB00116
Mapeband External corners x2	LB00117
Mapeband Waste Outlet Gasket	LB00119
Mapeband Pipe Inlet Kit	LB00120

MAPEI AquaDefense Kit



Materials

Ready to use, flexible, ultra-rapid drying waterproofing membrane for interior and exterior use in showers, wet rooms and on balconies. For use with all AKW formers. Can be reinforced with Mapetex SEL to provide an anti-fracture membrane.

FEATURES

- + Kit includes: 1x Mapei Primer G, 5 metres of Mapeband Tape (1200mm wide) & 7.5kg drum of Mapelastic Aquadefense
- + Very fast drying (can be tiled after 4 hours)
- + 100% watertight
- + One-component, ready-to-use liquid

Product Code: 21323

FormSafe® Kit



FormSafe® is a unique, pre-formed flexible self-adhesive waterproof membrane. Consisting of a 1mm thick rubberised waterproof layer, incorporating a fabric mesh on one side.

FEATURES

- + No drying time (ready to tile straight away)
- + Very strong & 100% watertight
- + Self-adhesive mat
- + Non-woven fabric, butyl & paper
- + Quick to apply & easy to install
- + No heating equipment required
- + Pre-formed internal corners
- + Lifetime of tile guarantee

Product Codes:

5m ² FormSafe® Kit	23610
10m ² FormSafe® Kit	23611

Don't forget to order an Electric Underfloor Heating Kit for your wet room floor. It's programmable thermostatic controller warms up floors quickly, helping to keep them dryer, safer and more comfortable to walk on. [See page 288.](#)



Threshold Kits

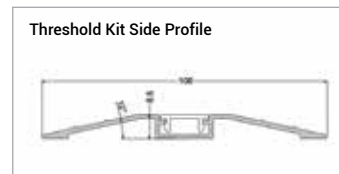

Threshold Kit Side Profile

**FEATURES**

- + Made from aluminium
- + Screw to floor and use silicone to seal
- + Helps to retain water within showering area
- + Can be used on wet floors
- + Screens can also be fitted with a threshold kit
- + Can be used as a ramp
- + Available as L-Shaped or Straight
- + Also available as Made-to-Measure

Product Codes:

900x900mm L-Shaped Threshold Kit	25026
1000x1000mm L-Shaped Threshold Kit	25027
1135x770mm L-Shaped Threshold Kit	25029L/R
1200x1200mm L-Shaped Threshold Kit	25030
1400x900mm L-Shaped Threshold Kit	25032L/R
1300x820mm L-Shaped Threshold Kit	25028L/R
1500x820mm L-Shaped Threshold Kit	25031L/R
2000mm Straight Threshold Kit	25025
Made-to-Measure Threshold Kit	25035

L/R in the product code denotes whether the kit is Left or Right handed.



Trays and Showering

SHOWER TRAYS **48**

Braddan Trays	49
Sulby Trays	57
Mullen® Trays	65
Low Profile Trays	72
Onyx Low Level Shower Tray	76

SHOWER SCREENS & ENCLOSURES **78**

Larenco Screens	79
Level Best Glass Screens	95
Standard Screens	97
Standard Wet Floor Screens	119
Silverdale® Screens	132
Silverdale® Wet Floor Screens	143
Sliding Screens	147
Made-to-Measure Screens	154
Standalone Cubicles	159
Showerloo Cubicles	162
Accessories	163
Portable Screens	163
Shower Curtain Rails	164
Shower Curtains	168
Shower Screen Handles	169

WASTES & PUMPS **170**

Gravity Wastes	171
Pumped Wastes	176
Digital Waste Pumps	177
AKW DigiPump SmartCare Plus Wireless Kit	179

SHOWERS **180**

Electric Showers	181
AKW SmartCare Plus	181
iTherm	184
Mira	186
Triton	187
Mixer Showers	188
Arka	188
Vettora	191

Showering Installation Guides:
See page 370

Shower Trays

AKW's shower trays are designed to fit wooden, concrete and screeded floors. They are quick and easy to install and there is an extensive range to choose from. All our trays are guaranteed for life to give you peace of mind.

You may also need:

Wastes & Pumps 170 >	Shower Screens 78 >
Showers 180 >	Wall panels 204 >
Safety Flooring 200 >	Timber 198 >

Compatible Shower Screen type (with reference code):

- Standard Shower Screens
- Glass Shower Screens
- Sliding Shower Screens
- Silverdale® Shower Screens



SHOWER TRAYS

Braddan Shower Tray



With extensive choice and easy installation, Braddan is a long-term favourite among specifiers, installers and end-users.

BENEFITS

- + The Braddan's unique design can create a full level access, surface-mounted or step-in shower enclosure
- + Integral added strength for extra peace of mind
- + A slip resistant surface makes them safe to use
- + A full selection of screens, curtains, rails and ramps means you can create the perfect bathroom for your requirements

FEATURES

- + Suitable for all floor types
- + A central waste position
- + No need for under tray foaming
- + Pipe duct kits are available to help with installation
- + We supply a 'trim to length kit' with 1800mm trays (can be trimmed to 1500mm – if trimmed the tray will not be suitable for corner installations but can be used in alcoves)
- + 5 waste options are available
- + All trays are supplied with a tiling upstand
- + Surface mounted tray height 40mm
- + Weight limit 190kg / 30 stone

i Our Braddan Installation Guide can be found on **page 372**

i Pipe Duct Kits are available. See **page 55**



Braddan Shower Tray (Size Options, Product Codes & Dimensions)

Braddan Shower Tray – 800 x 800mm

Tray only code:	16522
Tray with GW50 Gravity Waste code:	16522W
Tray with Upward Pump Waste code:	16523

Compatible shower screens:

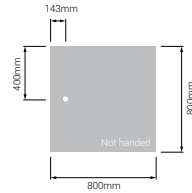

Braddan Shower Tray – 820 x 820mm

Tray only code:	16470
Tray with GW50 Gravity Waste code:	16470W
Tray with Upward Pump Waste code:	16471

Compatible shower screens:

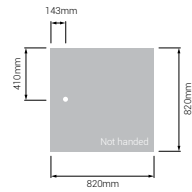

Braddan Shower Tray – 900 x 900mm

Tray only code:	16472
Tray with GW50 Gravity Waste code:	16472W
Tray with Upward Pump Waste code:	16473

Compatible shower screens:

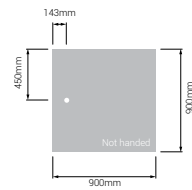

Braddan Shower Tray – 1000 x 700mm

Tray only code:	16000
Tray with GW50 Gravity Waste code:	16000W
Tray with Upward Pump Waste code:	16083

Compatible shower screens:

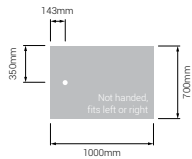

Braddan Shower Tray – 1000 x 800mm

Tray only code:	16528
Tray with GW50 Gravity Waste code:	16528W
Tray with Upward Pump Waste code:	16529

Compatible shower screens:

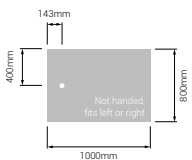

See **Compatible Shower Screens** starting on page 78

Braddan Shower Tray (Size Options, Product Codes & Dimensions)

Braddan Shower Tray – 1000 x 1000mm

Tray only code:	16071
Tray with GW50 Gravity Waste code:	16071W
Tray with Upward Pump Waste code:	16168

Compatible shower screens:

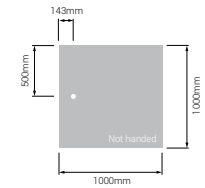

Braddan Shower Tray – 1200 x 650mm

Tray only code:	16360
Tray with GW50 Gravity Waste code:	16360W
Tray with Upward Pump Waste code:	16361

Compatible shower screens:

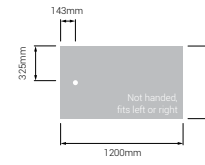

Braddan Shower Tray – 1200 x 700mm

Tray only code:	16006
Tray with GW50 Gravity Waste code:	16006W
Tray with Upward Pump Waste code:	16090

Compatible shower screens:

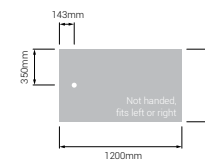

Braddan Shower Tray – 1200 x 760mm*

Tray only code:	16012
Tray with GW50 Gravity Waste code:	16012W
Tray with Upward Pump Waste code:	16175

Compatible shower screens:

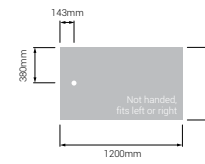

*Not suitable for use with standard screens when fitted with a pipe duct kit.

Braddan Shower Tray – 1200 x 820mm

Tray only code:	16045
Tray with GW50 Gravity Waste code:	16045W
Tray with Upward Pump Waste code:	16135

Compatible shower screens:

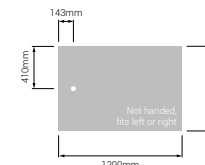
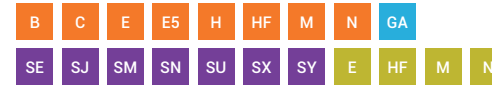

For **standard pump wastes** please order **tray only** and see page 56 for wastes

See **Compatible Shower Screens** starting on page 78

Braddan Shower Tray (Size Options, Product Codes & Dimensions)

Braddan Shower Tray – 1200 x 900mm

Tray only code: **16520**
 Tray with GW50 Gravity Waste code: **16520W**
 Tray with Upward Pump Waste code: **16521**

Compatible shower screens:

- E
- H
- HF
- M
- N
- GA
- SJ
- SM
- SN
- SU
- E
- HF
- M
- N

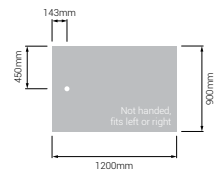

Braddan Shower Tray – 1300 x 700mm

Tray only code: **16013**
 Tray with GW50 Gravity Waste code: **16013W**
 Tray with Upward Pump Waste code: **16100**

Compatible shower screens:

- A
- B
- C
- E
- H
- HF
- J
- M
- N
- Q
- U
- X
- Y

- GA
- SE
- SJ
- SM
- SN
- SU
- SX
- SY
- A
- E
- M
- N

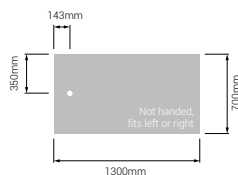

Braddan Shower Tray – 1300 x 820mm

Tray only code: **16050**
 Tray with GW50 Gravity Waste code: **16050W**
 Tray with Upward Pump Waste code: **16141**

Compatible shower screens:

- C
- E
- E5
- H
- HF
- J
- M
- N
- U
- Y
- GA

- SE
- SJ
- SM
- SN
- SU
- SX
- SY
- E
- HF
- M
- N

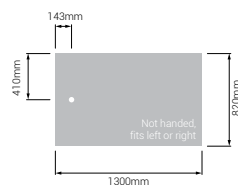

Braddan Shower Tray – 1420 x 700mm

Tray only code: **16022**
 Tray with GW50 Gravity Waste code: **16022W**
 Tray with Upward Pump Waste code: **16109**

Compatible shower screens:

- B
- H
- HF
- J
- K
- N
- Q
- U
- X
- Y
- GA

- SE
- SJ
- SM
- SN
- SU
- SX
- SY
- HF
- N

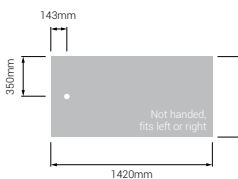

Braddan Shower Tray – 1420 x 820mm

Tray only code: **16058**
 Tray with GW50 Gravity Waste code: **16058W**
 Tray with Upward Pump Waste code: **16150**

Compatible shower screens:

- B
- H
- HF
- J
- K
- N
- U
- X
- Y
- GA

- SE
- SJ
- SM
- SN
- SU
- SX
- SY
- HF
- N

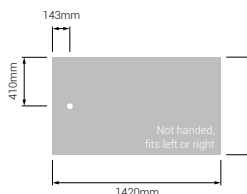

Braddan Shower Tray (Size Options, Product Codes & Dimensions)

Braddan Shower Tray – 1500 x 700mm

Tray only code: **16495**
 Tray with GW50 Gravity Waste code: **16495W**
 Tray with Upward Pump Waste code: **16496**

Compatible shower screens:

- B
- H
- HF
- N
- P
- TT
- X
- Z
- GA

- SE
- SJ
- SM
- SN
- SU
- SX
- SY
- HF
- N

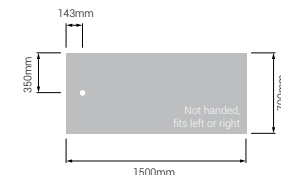

Braddan Shower Tray – 1500 x 820mm

Tray only code: **16531**
 Tray with GW50 Gravity Waste code: **16531W**
 Tray with Upward Pump Waste code: **16532**

Compatible shower screens:

- GA
- SE
- SM

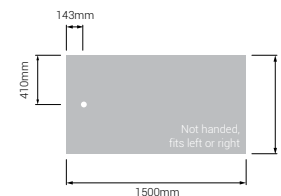

Braddan Shower Tray – 1700 x 700mm

Tray only code: **16028**
 Tray with GW50 Gravity Waste code: **16028W**
 Tray with Upward Pump Waste code: **16121**

Compatible shower screens:

- B
- H
- HF
- J
- K
- N
- P
- TT
- Y
- Z

- GA
- SJ
- SN
- SU
- SX
- SY
- HF
- N

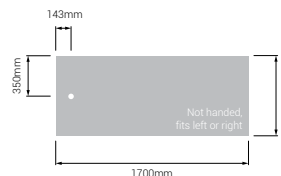

Braddan Shower Tray – 1800 x 700mm*

Tray only code: **16039**
 Tray with GW50 Gravity Waste code: **16039W**
 Tray with Upward Pump Waste code: **16129**

Compatible shower screens:

- H
- HF
- P
- TT
- Z
- GA
- SJ
- SN
- SU
- SX
- HF

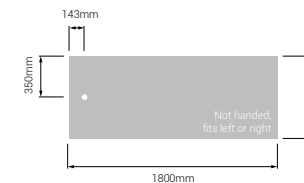

*Trim-to-length Kit included. Can be cut down to 1500mm to fit in an alcove.

Braddan Shower Tray (Size Options, Product Codes & Dimensions)

Braddan Shower Tray – 1800 x 820mm*

Tray only code:	16065
Tray with GW50 Gravity Waste code:	16065W
Tray with Upward Pump Waste code:	16161

Compatible shower screens:



*Trim-to-length Kit included. Can be cut down to 1500mm to fit in an alcove.

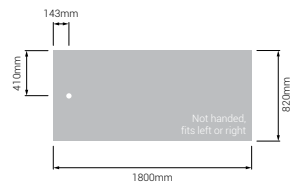

Braddan Shower Tray – 1400 x 900mm*

Tray only code:	16083
Tray with GW50 Gravity Waste code:	16063W
Tray with Upward Pump Waste code:	16082

Compatible shower screens:



*Trim-to-length Kit included. Can be cut down to 1500mm to fit in an alcove.

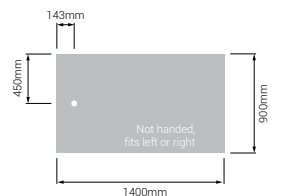

Braddan Shower Tray – 1800 x 900mm*

Tray only code:	16099
Tray with GW50 Gravity Waste code:	16099W
Tray with Upward Pump Waste code:	16120

Compatible shower screens:



*Trim-to-length Kit included. Can be cut down to 1500mm to fit in an alcove.

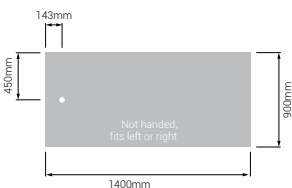

Braddan Shower Tray: Optional Extras

Braddan Pipe Duct Kit

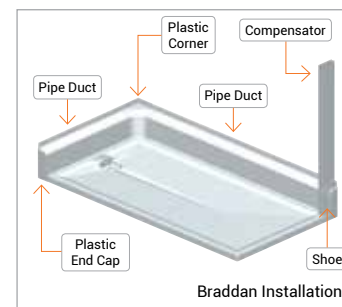

Pipe Duct Kits fit on to the edge of the tray to avoid the re-routing of existing pipework.

FEATURES

- + Fully waterproof mouldings
- + Quick installation
- + Substantial savings on time and labour costs
- + Requires Extra Wide Compensator (see page 167)

Product Codes:

Braddan 1800mm Pipe Duct & 2 Plastic End Caps	25038
Braddan 1000mm Pipe Duct & 2 Plastic End Caps	25039
Braddan Plastic Corner Assembly	25049

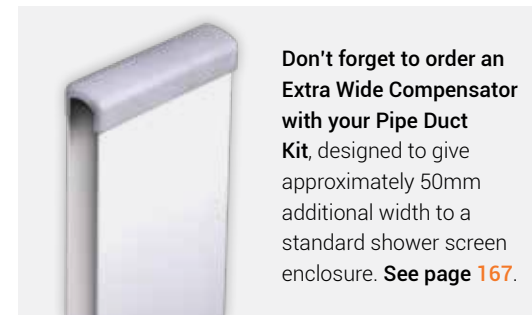

Don't forget to order an Extra Wide Compensator with your Pipe Duct Kit, designed to give approximately 50mm additional width to a standard shower screen enclosure. **See page 167.**

Braddan Shower Tray: Optional Extras

Braddan Waste Options



PW50 Standard Pumped Waste	
15mm	25122
22mm	25405
For details see page 176	



GW19 19mm Gravity Waste	25125
For details see page 171	



GW50 Gravity Waste	25126
For details see page 171	



Upward Discharge (factory fitted waste)	07130
--	--------------

Braddan Aluminium Ramp Kits



40mm Straight

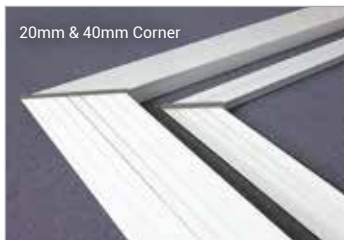

20mm & 40mm Corner

FEATURES

- + Allow easy wheelchair access
- + Available for surface mounted or semi recessed trays in 20mm and 40mm heights*
- + Supplied for corner or straight access
- + Can be cut-to-size on site
- + Made-to-Measure available

Product Code:

20mm Straight Ramp (length 1800mm)	25000
40mm Straight Ramp (length 1800mm)	25002
20mm Corner Ramp (1000 x 1000mm)**	25001
40mm Corner Ramp (1000 x 1000mm)	25003
Made-to-Measure	25012

*Actual height for 20mm ramp is 19.4mm. Actual height for 40mm ramp is 38.5mm.

**Maximum external dimensions: 145mm (40mm high) and 74mm (20mm high)

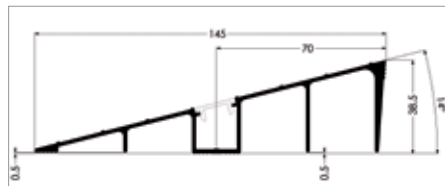
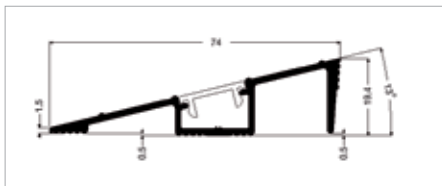

If using vinyl flooring please use made-to-measure kit

Sulby Shower Tray



Designed for easy installation onto unbreachable floors, the Sulby can go where others can't.

IN THE RANGE:

Sulby 1

90mm high with factory fitted integral waste

Sulby 2

110mm high for use with 90mm gravity or pumped wastes

Sulby 3

150mm high for use with 90mm gravity or pumped wastes

i Our Sulby Installation Guide can be found on [page 377](#)

i Pipe Duct Kits are available. See [page 62](#)

BENEFITS

- + Low entry step in tray for a defined showering area
- + Many flexible features make for simple fitting
- + Excellent drainage (35mm fall inside tray)
- + Choice of corner, side and end ramps for easy access
- + No messy pipework, improving the looks

FEATURES

- + Patented above floor gravity waste with 8 possible outlet points
- + Non-handed - fits left or right
- + Tiling flange supplied for alcove installations
- + Optional pipe duct kit available
- + No under tray foaming required
- + Trim-to-length kit supplied with 1800mm trays
- + In-built above floor gravity waste
- + Adjustable water trap of 31mm or 38mm



Sulby Shower Tray (Size Options, Product Codes & Dimensions)

Sulby Shower Tray – 820 x 820mm (90mm high)

Tray with Gravity Waste code: **17232**

Compatible shower screens:

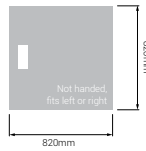

Sulby Shower Tray – 900 x 900mm (90mm high)

Tray with Gravity Waste code: **17231**

Compatible shower screens:

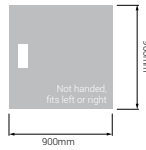

Sulby Shower Tray – 1000 x 1000mm (90mm high)

Tray with Gravity Waste code: **17055**

Compatible shower screens:

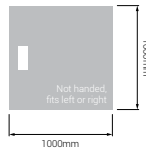

Sulby Shower Tray – 1200 x 700mm (90mm high)

Tray with Gravity Waste code: **17000**

Compatible shower screens:

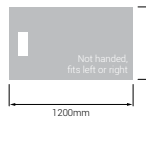
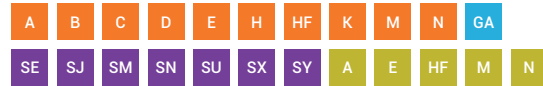

Sulby Shower Tray – 1200 x 760mm (90mm high)*

Tray with Gravity Waste code: **17006**

Compatible shower screens:

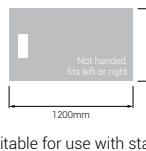
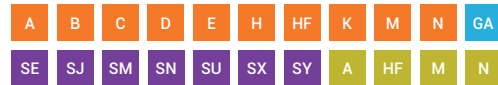

*Not suitable for use with standard screens when fitted with a pipe duct kit.

Sulby Shower Tray – 1200 x 820mm (90mm high)

Tray with Gravity Waste code: **17029**

Compatible shower screens:

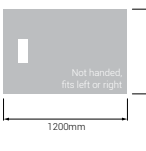
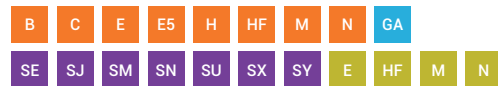

See **Compatible Shower Screens** starting on page 78

Sulby Shower Tray (Size Options, Product Codes & Dimensions)

Sulby Shower Tray – 1300 x 700mm (90mm or 110mm high)

90mm High Tray with Gravity Waste code: **17007**

110mm High Tray with Gravity Waste code: **17202**

Compatible shower screens:

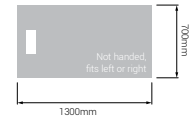

Sulby Shower Tray – 1300 x 820mm (90mm high)

Tray with Gravity Waste code: **17034**

Compatible shower screens:

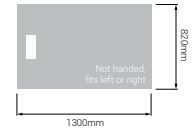
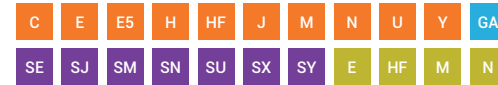

Sulby Shower Tray – 1420 x 700mm (90mm or 110mm high)

90mm High Tray with Gravity Waste code: **17016**

110mm High Tray with Gravity Waste code: **17201**

Compatible shower screens:



Sulby Shower Tray – 1420 x 820mm (90mm high)

Tray with Gravity Waste code: **17042**

Compatible shower screens:

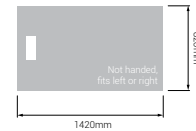

Sulby Shower Tray – 1800 x 700mm (90mm high)

Tray with Gravity Waste code*: **17023**

Compatible shower screens:



*Cut-to-length Kit included: can be cut down to 1500mm

Sulby Shower Tray – 1800 x 820mm (90mm high)

Tray with Gravity Waste code*: **17049**

Compatible shower screens:

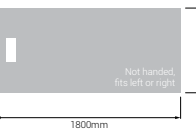

*Cut-to-length Kit included: can be cut down to 1500mm

Sulby 2 Shower Tray



A low entry step in shower tray, designed for easy installation onto unbreachable floors with integrated gravity waste.

BENEFITS

- + No need to excavate the floor
- + Many flexible features make for simple fitting
- + Ensures a water tight fixing to the wall
- + No messy pipework, improving the look
- + Quick and easy installation
- + Concealed within the height of the tray therefore no need to breach floor
- + Excellent 14lpm drainage (25404 waste)
- + Can be fitted with PW90 waste for pumped solution
- + Easy access for all
- + Compatible with dry wastes



Sulby 2 Shower Tray (Size Options, Product Codes & Dimensions)

Sulby 2 Shower Tray – 800 x 800mm (110mm high)

Tray only code: **17242**

Tray with Gravity Waste code: **17242W**

Compatible shower screens:

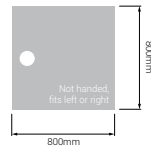

Sulby 2 Shower Tray – 1000 x 700mm (110mm high)

Tray only code: **17243**

Tray with Gravity Waste code: **17243W**

Compatible shower screens:

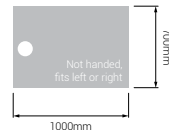

Sulby 2 Shower Tray – 1200 x 700mm (110mm high)

Tray only code: **17244**

Tray with Gravity Waste code: **17244W**

Compatible shower screens:

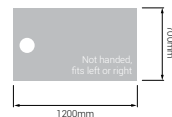

Sulby 2 Shower Tray (Size Options, Product Codes & Dimensions)

Sulby 2 Shower Tray – 1200 x 900mm (110mm high)

Tray only code: **17240**

Tray with Gravity Waste code: **17240W**

Compatible shower screens:

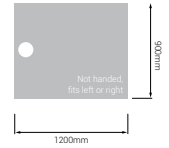

Sulby 2 Shower Tray – 1300 x 700mm (110mm high)

Tray only code: **17245**

Tray with Gravity Waste code: **17245W**

Compatible shower screens:



Sulby 2 Shower Tray – 1420 x 700mm (110mm high)

Tray only code: **17241**

Tray with Gravity Waste code: **17241W**

Compatible shower screens:

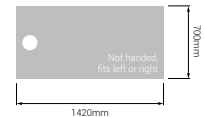

Sulby 2 Shower Tray – 1500 x 700mm (110mm high)

Tray only code: **17246**

Tray with Gravity Waste code: **17246W**

Compatible shower screens:



Sulby 2 Shower Tray – 1700 x 700mm (110mm high)

Tray only code: **17247**

Tray with Gravity Waste code: **17247W**

Compatible shower screens:

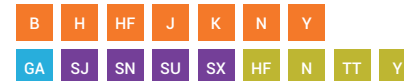

See **Compatible Shower Screens** starting on page 78

Sulby Shower Tray: Optional Extras

Sulby Pipe Duct Kit

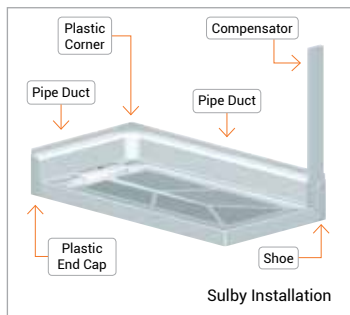

Pipe Duct Kits fit on to the edge of the tray to avoid the re-routing of existing pipework.

FEATURES

- + Fully waterproof mouldings
- + Quick installation
- + Substantial savings on time and labour costs
- + Requires Extra Wide Compensator (see page 167)

Product Codes:

Sulby 1800mm Pipe Duct & 2 Plastic End Caps	25038
Sulby 1000mm Pipe Duct & 2 Plastic End Caps	25039
Sulby Plastic Corner Assembly	25049



Don't forget to order an **Extra Wide Compensator with your Pipe Duct Kit**, designed to give approximately 50mm additional width to a standard shower screen enclosure. See page 167.

Sulby 1 Waste Installation



ABS cover lifts off to expose waste



Trap and strainer can be removed to give clear access for rodding



A stop end is supplied for fitting to the unused waste outlet

Sulby Ramps



Straight Ramp



Corner Ramp



Step

Sulby ramps are designed to be removed when not in use, so they are not fixed in position.

FEATURES

- + Straight & corner ramps, plus a step are available
- + Ramp designed to suit 90mm high Sulby Shower Trays only
- + Step can be used with 110mm high Sulby Shower Trays

Product Codes:

Straight Sulby Ramp 770(w) x 480(d) x 90(h)mm	25009
Corner Sulby Ramp 770(w) x 630(d) x 90(h)mm	25008
Sulby Step 700(w) x 300(d) x 45(h)mm	25007

Please note: Gradient for ramps is 1:6. Dimensions are outside dimensions.

Sulby 2 Waste Options



PW90 Pumped Waste

15mm	25105
22mm	25406

For details see page 176



Low Depth GW90

25404

For details see page 172



GW90-2 Low Height Wet Waste with Vinyl Floor Adaptor

25499-UK

For details see page 173



GW90-2 Low Height Wet Waste with TF Tiled Floor Adaptor

254198-UK

For details see page 172



Mullen® Shower Tray



Using patented integrated edging and built-in features, Mullen® is quick and easy to fit.

BENEFITS

- + Level showering for easy access
- + Exceptionally watertight seals, thanks to a pioneering Intergrip® strip
- + Quick draining, with a 25mm fall inside tray
- + Unrivalled strength and stability, using compressed GRP
- + Pre-formed fixing holes ensure quick and easy installation
- + Weight limit 190kg / 30 stones



FEATURES

- + A 27mm floor recess is all that's needed
- + Surface mounted option (ramp available)
- + A corner waste position helps avoid joists
- + Corner and alcove trays are supplied with cut-to-length kits
- + Built in tiling upstands on 2 or 3 sides complete the all-round integrity of the water seals
- + Floor tiling and alcove adaptor kits are available
- + No under tray foaming is needed

i Our Mullen® Installation Guide can be found on **page 375**



Mullen® Shower Tray (Size Options, Product Codes & Dimensions)

Mullen® Shower Tray – 1000 x 1000mm*

Tray only code: **26100**

Tray with Gravity Waste code: **26074**

Compatible shower screens: **Corner installations only**

- BF C E H HF GA SE E HF

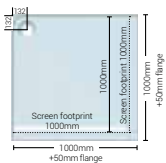

Mullen® Shower Tray – 1200 x 700mm*

Tray only code: **26101L/R**

Tray with Gravity Waste code: **26106L/R**

Compatible shower screens: **Corner installations only**

- A B C D E H HF K GA
SE SX SY E HF

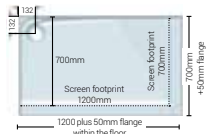

Mullen® Shower Tray – 1200 x 820mm*

Tray only code: **26072L/R**

Tray with Gravity Waste code: **26073L/R**

Compatible shower screens: **Corner installations only**

- B C E E5 HF GA SE SX SY E HF

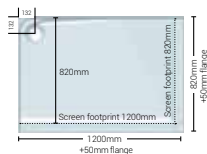

Mullen® Shower Tray – 1300 x 700mm*

Tray only code: **26102L/R**

Tray with Gravity Waste code: **26109L/R**

Alcove Adaptor Kit code: **26262L/26261R**

Compatible shower screens:

- A B C E H HF J M N U X Y
GA SE SJ SM SN SU SX SY A E HF M N

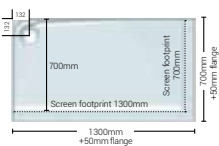

Mullen® Shower Tray – 1300 x 820mm*

Tray only code: **26107L/R**

Tray with Gravity Waste code: **26111L/R**

Alcove Adaptor Kit code: **26264L/26263R**

Compatible shower screens:

- C E E5 H HF J M N U Y
SE SJ SM SN SU SX SY E HF M N

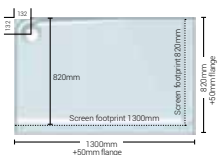

Mullen® Shower Tray (Size Options, Product Codes & Dimensions)

Mullen® Shower Tray – 1420 x 700mm*

Tray only code: **26104L/R**

Tray with Gravity Waste code: **26110L/R**

Alcove Adaptor Kit code: **26262L/26261R**

Compatible shower screens:

- B H HF J K N Q U X Y
GA SE SJ SM SN SU SX SY B HF N X Y

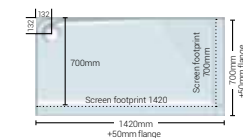

Mullen® Cut-to-Length Shower Tray – 1800 x 700mm*

Tray only code: **26108 (Non-handed)**

Tray with Gravity Waste Code: **26112 (Non-handed)**

Compatible shower screens: **Alcove installations only**

- H HF P TT Z GA SJ SN SU HF

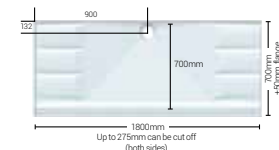

Mullen® Cut-to-Length Shower Tray – 1800 x 820mm*

Tray only code: **26192 (Non-handed)**

Tray with Gravity Waste Code: **26193 (Non-handed)**

Compatible shower screens: **Alcove installations only**

- H HF P TT Z GA SJ SN SU HF

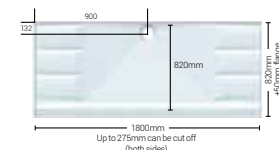

Mullen® Cut-to-Length Shower Tray Stop Ends

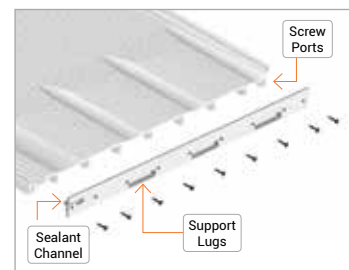

Each 1800mm Mullen® tray is supplied with a left and right hand Stop End.

FEATURES

- + Alcove trays can be trimmed by up to 275mm on two sides for 1800mm trays
- + Special designed stop ends give a strong mechanical waterproof joint

*Plus 50mm flange.

See **Compatible Shower Screens** starting on page 78

Other **Gravity and Pumped Wastes** available see page 170

Mullen® Shower Tray: Optional Extras

Mullen® Ramp Kits



Above Flooring



Below Flooring

Mullen® trays can be surface mounted on screeded floors with the addition of trimmable ramp options for easy access.

FEATURES

- + Can be installed above or below altro flooring

Product Codes:

Surface Mount Ramp Universal Kit (1800 x 1000mm)	26272
--	--------------

Underfloor Covering Universal Ramp Kit (1800 x 1000mm)	26273
--	--------------

Mullen Intergrid®

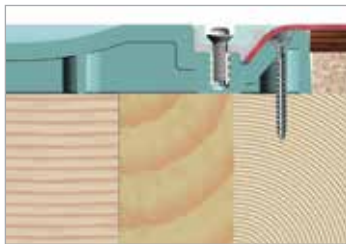

Please note: Typical floorboards are 18mm thick. It would be necessary to lay plywood on the bathroom floor to bring the floor up to the tray height, for complete level access.

The key benefit of the Mullen® shower tray is its unique clamping strip (Intergrid®) which grips and seals vinyl flooring into the tray for a water tight seal.

FEATURES

- + Flooring can be fitted after the tray and screen have been installed avoiding unnecessary site visits

Product Codes:

700mm Clamping Strip	03-006-144
----------------------	-------------------

820mm Clamping Strip	03-006-145
----------------------	-------------------

1000mm Clamping Strip	03-006-146
-----------------------	-------------------

1200mm Clamping Strip	03-006-147
-----------------------	-------------------

1300mm Clamping Strip	03-006-148
-----------------------	-------------------

1420mm Clamping Strip	03-006-149
-----------------------	-------------------

1800mm Clamping Strip	03-006-151
-----------------------	-------------------

Clamping Strip Cover Cap (10 Pack)	26269
------------------------------------	--------------

Clamping Strip Corner Piece	07199
-----------------------------	--------------

See **timber** on page 198

Mullen® Shower Tray: Optional Extras

Mullen® Floor Tiling Kits

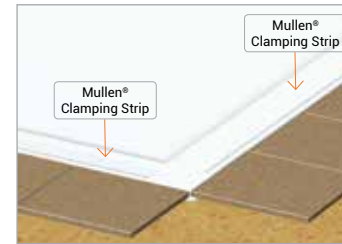

Patent pending.

Maintain level access showering when using floor tiles. Fits under the Mullen® Clamping Strip and tiles.

FEATURES

- + Fully waterproof mouldings
- + Quick installation, saving on time and labour costs
- + Maximum thickness of tiles and adhesive 10.5mm
- + 1800mm (x1) & 1000mm (x1) tiling adaptor strip, Corner Block Assembly (x1) & Pack of Fixings/Caps

Product Code:

Floor Tiling Kit	26259
-------------------------	--------------

Mullen® Pipe Duct Kit

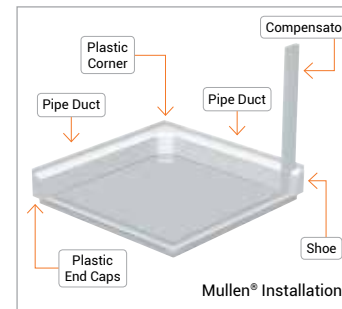

Pipe Duct Kits fit on to the edge of the tray to avoid the re-routing of existing pipework.

FEATURES

- + Fully waterproof mouldings
- + Quick installation
- + Substantial savings on time and labour costs
- + Requires Extra Wide Compensator (see page 167)

Product Codes:

Mullen® 1800mm Pipe Duct & 2 Plastic End Caps	26265
---	--------------

Mullen® 1000mm Pipe Duct & 2 Plastic End Caps	26266
---	--------------

Mullen® Plastic Corner Assembly*	26274
----------------------------------	--------------



Don't forget to order an Extra Wide Compensator with your Pipe Duct Kit, designed to give approximately 50mm additional width to a standard shower screen enclosure. **See page 167.**

Mullen® Shower Tray: Optional Extras

Mullen® Wallboard Adaptor Kit



Registered design.

Allows easy fitting of 11mm thick wall board.
Attaches directly to the Mullen®'s built in tiling flange.

FEATURES

- + Mitre cut ends
- + Quick installation
- + Substantial savings on time and labour costs
- + Should be used with wet floor screens

Product Code:

1800mm (x1) & 1000mm (x1) lengths, Plastic End Caps (x2)	26270
---	--------------

Mullen® Alcove Adaptor Kits

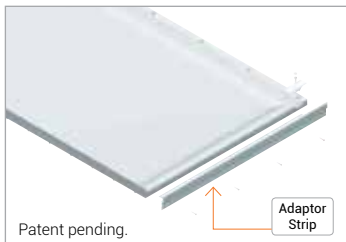

Patent pending.

Adaptor Strip

Convert a corner tray to an alcove tray. Fits onto the edge of the tray to give a watertight seal and tiling upstand.

FEATURES

- + **Kit Contents:** Alcove Adaptor Strip (x1), Corner Block Assembly (x1) & Pack of Fixings/Caps

Product Codes:

1300 x 700mm (Right Hand Tray)	26261
1300 x 700mm (Left Hand Tray)	26262
1300 x 820mm (Right Hand Tray)	26263
1300 x 820mm (Left Hand Tray)	26264
1420 x 700mm (Right Hand Tray)	26261
1420 x 700mm (Left Hand Tray)	26262



Corner Block

Mullen® Waste Options

**PW90 Pumped Waste**

15mm	25105
22mm	25406

For details see [page 176](#)**Low Depth GW90** **25404**For details see [page 32](#)**GW90 90mm Diameter Gravity Waste****25120**For details see [page 31](#)**GW90-2 Low Height Wet Waste with TF Tiled Floor Adaptor** **254198-UK**For details see [page 172](#)**GW90-2 Low Height Wet Waste with Vinyl Floor Adaptor****25499-UK**For details see [page 173](#)**DW90 Low Depth Dry Shower Waste – with Tuff Form® Vinyl Floor Adaptor** **25419-UK**For details see [page 36](#)**DW90 Low Depth Dry Shower Waste – with Tuff Form® Tiled Floor Adaptor** **25418-UK**For details see [page 35](#)

Low Profile Shower Tray



Suited to wooden floors and one of the easiest trays to install, Low Profile can be fitted for either level or low level access.

BENEFITS

- + At just 32mm high, the Low Profile tray is ideal for where level or low access is needed
- + Excellent water drainage with a 25mm fall inside the tray
- + Reinforced with steel sections for extra strength
- + A large selection of screens, curtains and rails give real choice
- + Slip resistant surface for added safety
- + Robust and easy to clean

FEATURES

- + Easy installation, thanks to offset waste position to avoid joists
- + 'Non handed' – it fits left or right
- + 1800mm trays supplied with a trim to length kit
- + No under tray foaming required
- + Three separate tiling flanges supplied
- + Optional pipe duct kit available (see page 75)

Please note: Not recommended with pumped wastes



i Our Low Profile Installation Guide can be found on **page 379**

i Pipe Duct Kits are available. See **page 75**



Low Profile Shower Tray (Size Options, Product Codes & Dimensions)

Low Profile Shower Tray – 1000 x 1000mm

Tray only code: **18055**

Tray with Gravity Waste code: **18174**

Compatible shower screens:

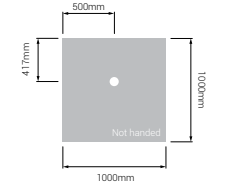

Low Profile Shower Tray – 1200 x 700mm

Tray only code: **18000**

Tray with Gravity Waste code: **18070**

Compatible shower screens:

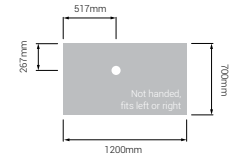

Low Profile Shower Tray – 1200 x 760mm

Tray only code: **18006**

Tray with Gravity Waste code: **18071**

Compatible shower screens:

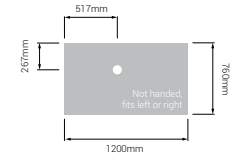
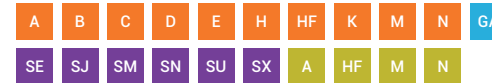

*Not suitable for use with standard screens when fitted with a pipe duct kit.

Low Profile Shower Tray – 1200 x 820mm

Tray only code: **18029**

Tray with Gravity Waste code: **18170**

Compatible shower screens:

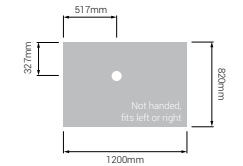
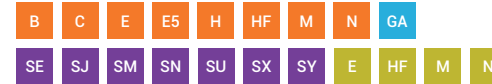

Low Profile Shower Tray – 1300 x 700mm

Tray only code: **18007**

Tray with Gravity Waste code: **18072**

Compatible shower screens:

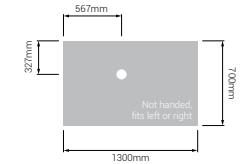

Low Profile Shower Tray (Size Options, Product Codes & Dimensions)

Low Profile Shower Tray – 1300 x 820mm

Tray only code: **18034**

Tray with Gravity Waste code: **18171**

Compatible shower screens:

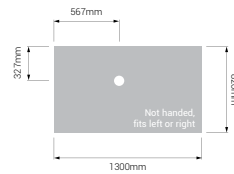
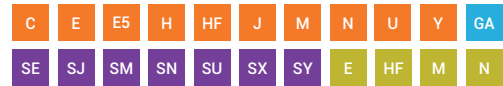

Low Profile Shower Tray – 1420 x 700mm

Tray only code: **18016**

Tray with Gravity Waste code: **18073**

Compatible shower screens:

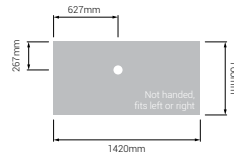

Low Profile Shower Tray – 1420 x 820mm

Tray only code: **18042**

Tray with Gravity Waste code: **18172**

Compatible shower screens:

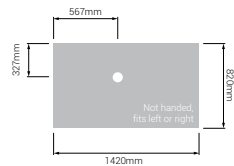

Low Profile Shower Tray – 1800 x 700mm

Tray only code: **18023**

Tray with Gravity Waste code: **18074**

Compatible shower screens:



*Cut-to-length Kit included: can be cut down to 1500mm

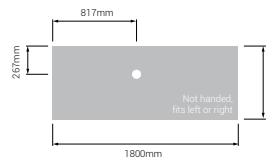

Low Profile Shower Tray – 1800 x 820mm

Tray only code: **18049**

Tray with Gravity Waste code: **18173**

Compatible shower screens:



*Cut-to-length Kit included: can be cut down to 1500mm

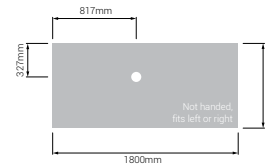

See **Compatible Shower Screens** starting on page 78

Low Profile® Tray: Optional Extras

Low Profile® Waste Options



GW90 90mm Diameter Gravity Waste **25120**
For details see **page 31**



Low Depth GW90 **25404**
For details see **page 32**



GW90-2 Low Height Wet Waste with Vinyl Floor Adaptor **25499-UK**
For details see **page 173**



GW90-2 Low Height Wet Waste with TF Tiled Floor Adaptor **254198-UK**
For details see **page 172**

Low Profile® Pipe Duct Kit

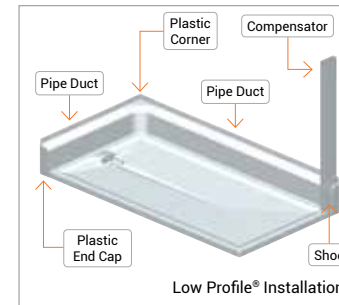

Pipe Duct Kits fit on to the edge of the tray to avoid the re-routing of existing pipework.

FEATURES

- + Fully waterproof mouldings
- + Quick installation
- + Substantial savings on time and labour costs
- + Requires Extra Wide Compensator (see page 167)

Product Codes:

Low Profile® 1800mm Pipe Duct & 2 Plastic End Caps	25038
Low Profile® 1000mm Pipe Duct & 2 Plastic End Caps	25039
Low Profile® Plastic Corner Assembly	25049



Don't forget to order an Extra Wide Compensator with your Pipe Duct Kit, designed to give approximately 50mm additional width to a standard shower screen enclosure. **See page 167.**

Onyx Low Level Shower Tray

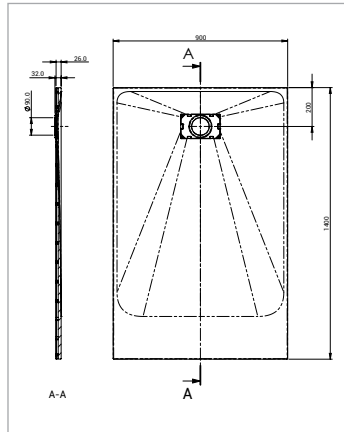
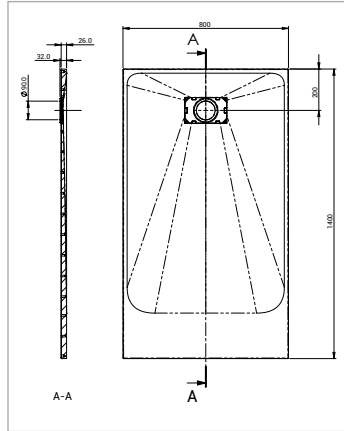

Onyx Low Level Shower Tray

Onyx is the design extra flat design or recessed tray.

FEATURES:

- + Contemporary design, slate texture finish
- + Strength, made from SMC (Sheet Moulding Compound)
- + Slip resistant
- + Lifetime warranty
- + Easy installation, lightweight (under 25kg)
- + Low Profile (26mm)
- + Can be recessed or surface mounted

BENEFITS

- + Available in white (RAL9003), grey (RAL7036) and black (RAL7021)
- + Concealed shallow depth waste (54mm under the tray)
- + Colour and finish coordinated waste cover with slots to improve water flow
- + Non-deformable webbed structure ensuring excellent shock and impact resistance and easy installation
- + Weight load: 200kg / 31.5 Stone
- + Compatible with Larenco, Level Best, Silverdale and Standard Screens

Product Codes:

Tray size	White tray only	Black Tray Only	Grey Tray Only
800 x 800	11886	11890	11892
900 x 900	11887	11891	11893
1000 x 700	11888	11852	11875
1000 x 800	11851	11854	11876
1200 x 700	11889	11856	11877
1200 x 800	11853	11872	11878
1200 x 900	11855	11874	11879
1400 x 800	11871	11858	11880
1400 x 900	11873	11860	11881
1600 x 800	11857	11862	11882
1600 x 900	11859	11864	11883
1700 x 800	11861	11866	11884
1700 x 900	11863	11868	11885
1800 x 800	11865	11890	11892
1800 x 900	11867	11891	11893
1400 x 900	11886	11852	11875

Related Product Codes – Must be ordered with the Onyx Tray.

Waste DW90 for Onyx Tray	25496
Pipe Adapter Kit	16-006-058

Note: The Onyx Tray is only compatible with dedicated redesigned DW90 waste, water flow: 30l/min, product code: 25496. This must also be ordered with 16-006-058 pipe adapter kit.

Shower Screens & Enclosures

All of our shower screens are designed specifically for the mobility and domestic markets and are both extremely practical and stylish.

You may also need:

Wastes & Pumps	Showers
170 >	180 >

Shower Seats	Shower Trays
226 >	48 >

Wall Panels	Tiles & Accessories
204 >	194 >

Shower Screen type (with tray compatibility reference code):

- Standard Shower Screens
- Glass Shower Screens
- Sliding Shower Screens
- Silverdale® Shower Screens

L/R in the product code denotes whether the screen is Left or Right handed.



Larenco



Level Best



Standard



Silverdale®



Larenco Sliding



Standalone

LARENCO SHOWER SCREENS

Beautifully reflecting AKW's expertise, the Larenco modular glass screen range fits perfectly in any home, representing the ultimate in inclusive living*.



Larenco Saloon Door

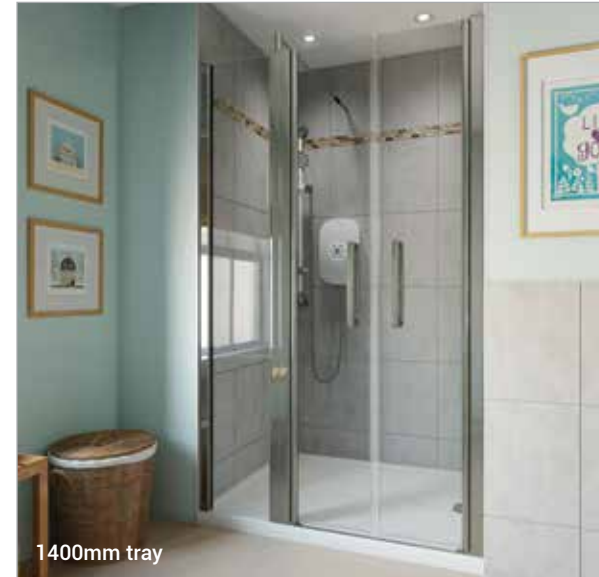

1400mm tray

These full height bi-parting shower screens are a flexible solution for your shower room with a Stay Clear coating for ease of cleaning. The design offers a spacious showering area with a sleek and sophisticated look, the perfect finish to your shower room.

Dimensions, Size Options & Product Codes:

Dimensions (lengths) in mm:

Shower Tray Size Options:	Door Width	Fixed Panel Width	Overall Width	Code:
800	800	-	785 - 812	26654
900	900	-	885 - 912	26655
1000	1000	-	985 - 1012	26656
1200	800	400	1157 - 1202	26975
1300	900	400	1257 - 1302	26976
1400	1000	400	1357 - 1402	26977

* All of the ranges can be bumped up by 20 mm if you use a wide wall compensator.

Please note: Larenco Saloon Doors can only be installed in an alcove installation or for an enclosure scenario to an end panel attached to an inline panel.

*All alcove Larenco configurations, apart from the Sliding door, are compatible with vinyl safety flooring.

Order: 01905 823 299 | orders.akw-ltd.co.uk

Technical support: 01905 560 219

Larenco Sliding Door

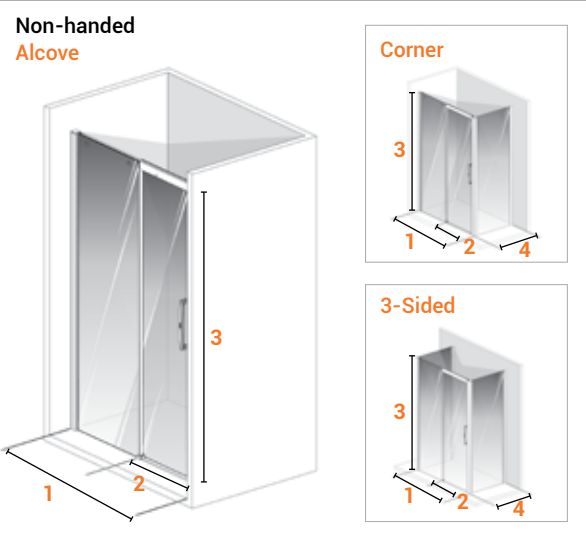

FEATURES

- + Non-handed
- + Suitable for shower trays and wet floors
- + Sliding door
- + Full height
- + Optional side panels to make Corner or 3-Sided Enclosures
- + Lightweight 6mm toughened safety glass

Dimensions, Size Options & Product Codes:

Dimensions (lengths) in mm:

Shower Tray Size Options:	1 Alcove	1 Corner	1 3-sided	2	3	4	Code:
1200	1159 - 1196	1162 - 1208	1165 - 1221	470	2000	-	27626
1400	1359 - 1396	1362 - 1408	1365 - 1421	570	2000	-	27627
1500	1459 - 1496	1462 - 1508	1465 - 1521	620	2000	-	27628
1700	1659 - 1696	1662 - 1708	1665 - 1721	720	2000	-	27629
700	-	-	-	-	2000	677 - 695	27630
800	-	-	-	-	2000	777 - 795	27631
900	-	-	-	-	2000	877 - 895	27632

* All of the ranges can be bumped up by 20 mm if you use a wide wall compensator.

Larenco Alcove Full Height Door

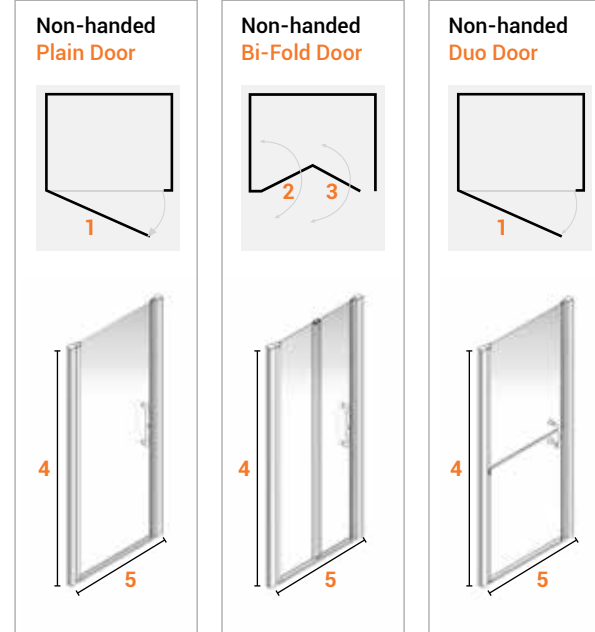

FEATURES

- + Non-handed
- + Suitable for shower trays and wet floors
- + Alcove installation
- + One door
- + Full height
- + Plain Door, Bi-Fold Door and Duo Door options available
- + Lightweight 6mm toughened safety glass

Dimensions, Size Options & Product Codes:

Dimensions (lengths) in mm:

Shower Tray Size Options:	1	2	3	4	5	Plain Door Code:	Bi-Fold Door Code:	Duo Door Code:
760	650	350	310	1900	777 - 795	-	27537	-
800	690	370	330	1900	817 - 835	26800	26802	26805
900	790	420	380	1900	917 - 935	26801	26803	26806
1000	890	470	430	1900	1017 - 1035	27605	26804	27606

* All of the ranges can be bumped up by 20 mm if you use a wide wall compensator.

Larenco Alcove Half Height Door

Non-handed Plain Door

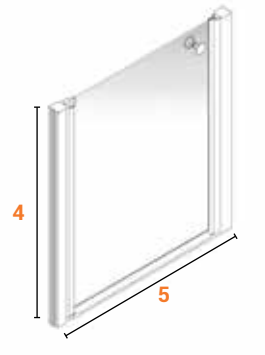
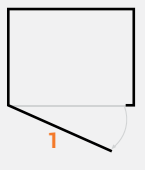

Non-handed Bi-Fold Door

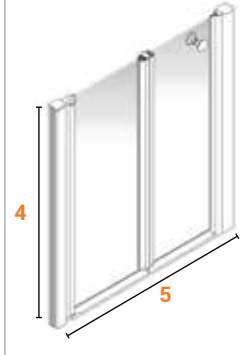
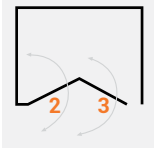

FEATURES

- + Non-handed
- + Suitable for shower trays and wet floors
- + Alcove installation
- + One door
- + Half height
- + Plain Door and Bi-Fold Door options available
- + Lightweight 6mm toughened safety glass

Dimensions, Size Options & Product Codes:

Dimensions (lengths) in mm:

Shower Tray Size Options:	1	2	3	4	5	Plain Door Code:	Bi-Fold Door Code:
800	690	370	330	900	817 - 835	26807	26809
900	790	420	380	900	917 - 935	26808	26810
1000	890	470	430	900	1017 - 1035	27607	26811

* All of the ranges can be bumped up by 20 mm if you use a wide wall compensator.

Larenco Alcove Full Height Door with Inline Panel

Non-handed Plain Door

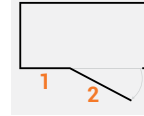

Non-handed Bi-Fold Door

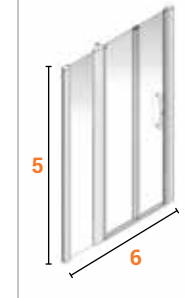

Non-handed Duo Door

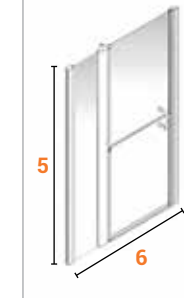
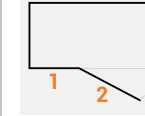

FEATURES

- + Non-handed
- + Suitable for shower trays and wet floors
- + Alcove installation
- + One door with one inline panel
- + Full height
- + Plain Door, Bi-Fold Door and Duo Door options available
- + Lightweight 6mm toughened safety glass

Dimensions, Size Options & Product Codes:

Dimensions (lengths) in mm:

Shower Tray Size Options:	1	2	3	4	5	6	Plain Door Code:	Bi-Fold Door Code:	Duo Door Code:
1200	417 - 436	690	370	330	1900	1189 - 1225	26852	26853	26854
1300	517 - 536	790	420	380	1900	1289 - 1325	26857	26858	26859
1400	617 - 636	890	470	430	1900	1389 - 1425	27578	27610	27577

* All of the ranges can be bumped up by 20 mm if you use a wide wall compensator.

Larenco Alcove Half Height Door with Inline Panel

Non-handed Plain Door

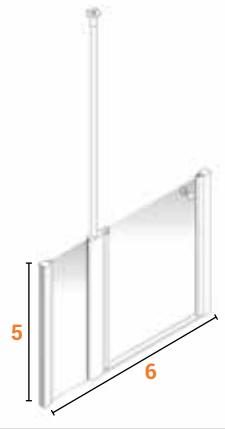
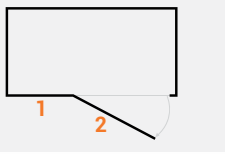

Non-handed Bi-Fold Door

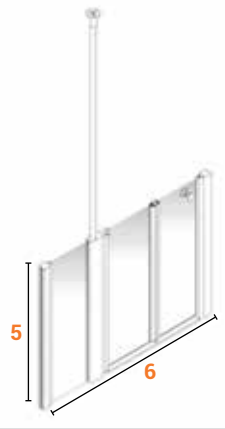
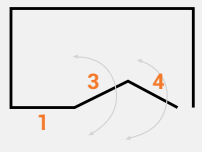

FEATURES

- + Non-handed
- + Suitable for shower trays and wet floors
- + Alcove installation
- + One door with one inline panel
- + Half height
- + Plain Door and Bi-Fold Door options available
- + Lightweight 6mm toughened safety glass
- + Includes floor to ceiling pole
- + No curtain or rail supplied

Dimensions, Size Options & Product Codes:

Dimensions (lengths) in mm:

Shower Tray Size Options:	1	2	3	4	5	6	Plain Door Code:	Bi-Fold Door Code:
1200	417 - 436	690	370	330	900	1189 - 1225	26855	26856
1300	417 - 436	790	420	380	900	1289 - 1325	26860	26861
1400	417 - 436	890	470	430	900	1389 - 1425	27580	27613
1500	375 - 395	995	-	-	900	1489 - 1525	26944	-

* All of the ranges can be bumped up by 20 mm if you use a wide wall compensator.

Larenco Alcove Full Height Door with Two Inline Panels

Non-handed Plain Door

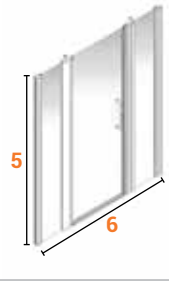

Non-handed Bi-Fold Door

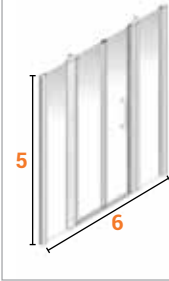

Non-handed Duo Door

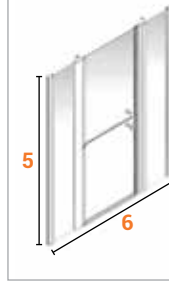
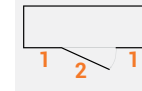

FEATURES

- + Non-handed
- + Suitable for shower trays and wet floors
- + Alcove installation
- + One door with two inline panels
- + Full height
- + Plain Door, Bi-Fold Door and Duo Door options available
- + Lightweight 6mm toughened safety glass

Dimensions, Size Options & Product Codes:

Dimensions (lengths) in mm:

Shower Tray Size Options:	1	2	3	4	5	6	Plain Door Code:	Bi-Fold Door Code:	Duo Door Code:
1600	417 - 436	690	370	330	1900	1561 - 1615	-	-	27608
1700	417 - 436	790	420	380	1900	1661 - 1715	27591	27592	27590
1800	417 - 436	890	470	430	1900	1761 - 1815	27596	27597	27595

* All of the ranges can be bumped up by 20 mm if you use a wide wall compensator.

Larenco Alcove Half Height Door with Two Inline Panels

Non-handed Plain Door

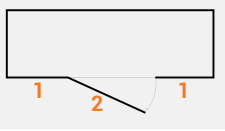

Non-handed Bi-Fold Door

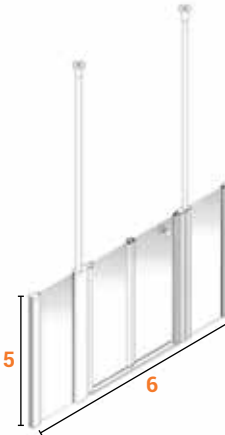
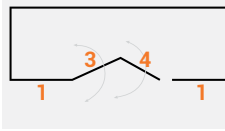

FEATURES

- + Non-handed
- + Suitable for shower trays and wet floors
- + Alcove installation
- + One door with two inline panels
- + Half height
- + Plain Door and Bi-Fold Door options available
- + Lightweight 6mm toughened safety glass
- + Includes floor to ceiling pole
- + No curtain or rail supplied

Dimensions, Size Options & Product Codes:

Dimensions (lengths) in mm:

Shower Tray Size Options:	1	2	3	4	5	6	Plain Door Code:	Bi-Fold Door Code:
1700	417 - 436	790	420	380	900	1661 - 1715	27593	27594
1800	417 - 436	890	470	430	900	1761 - 1815	27598	27599

* All of the ranges can be bumped up by 20 mm if you use a wide wall compensator.

Larenco Corner with Two Full Height Doors

Handed Plain Door

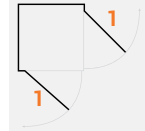

Handed Bi-Fold Door

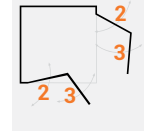

Handed Duo Door

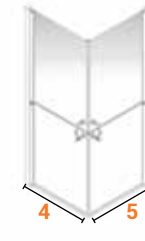
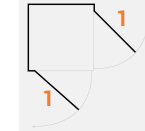

FEATURES

- + Handed
- + Suitable for shower trays and wet floors
- + Corner installation
- + Two doors
- + Full height
- + Plain Door, Bi-Fold Door and Duo Door options available
- + Lightweight 6mm toughened safety glass

Dimensions, Size Options & Product Codes:

Dimensions (lengths) in mm:

Shower Tray Size Options:	1	2	3	4	5	6	Plain Door Code:	Bi-Fold Door Code:	Duo Door Code:
760 x 760	-	350	310	734 - 747	734 - 747	1900	-	26840	-
800 x 800	690	370	330	774 - 787	774 - 787	1900	26838	26841	26844
800 x 1000	695/890	-	-	774 - 787	974 - 987	1900	27559	-	-
900 x 900	790	420	380	874 - 887	874 - 887	1900	26839	24842	26845
1000 x 800	890/690	-	-	974 - 987	774 - 787	1900	27558	-	-
1000 x 1000	890	470	430	974 - 987	974 - 987	1900	27566	27614	27565

* All of the ranges can be bumped up by 20 mm if you use a wide wall compensator.

Larenco Corner with Two Half Height Doors

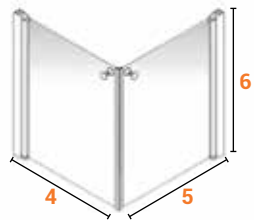
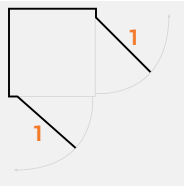
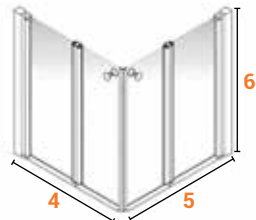
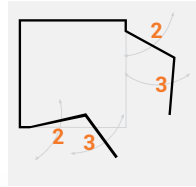
Handed Plain Door**Handed Bi-Fold Door****FEATURES**

- + Handed
- + Suitable for shower trays and wet floors
- + Corner installation
- + Two doors
- + Half height
- + Plain Door and Bi-Fold Door options available
- + Lightweight 6mm toughened safety glass
- + No curtain or rail supplied

Dimensions, Size Options & Product Codes:

Dimensions (lengths) in mm:

Shower Tray Size Options:	1	2	3	4	5	6	Plain Door Code:	Bi-Fold Door Code:
800 x 800	690	370	330	774 - 787	774 - 787	900	26846	26848
900 x 900	790	420	380	874 - 887	874 - 887	900	26847	26849
1000 x 1000	890	470	430	974 - 987	974 - 987	900	27567	27615
1200 x 1200	-	570	530	1174 - 1187	1174 - 1187	900	-	27571

* All of the ranges can be bumped up by 20 mm if you use a wide wall compensator.

Larenco Corner with Full Height Door & Side Panel

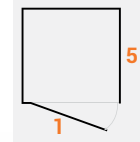
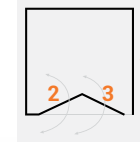
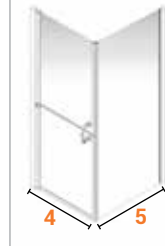
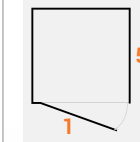
Non-handed Plain Door**Non-handed Bi-Fold Door****Non-handed Duo Door****FEATURES**

- + Non-handed
- + Suitable for shower trays and wet floors
- + Corner installation
- + One door with a side panel
- + Full height
- + Plain Door, Bi-Fold Door and Duo Door options available
- + Lightweight 6mm toughened safety glass

Dimensions, Size Options & Product Codes:

Dimensions (lengths) in mm:

Shower Tray Size Options:	1	2	3	4	5	6	Plain Door Code:	Bi-Fold Door Code:	Duo Door Code:
800 x 800	690	370	330	783 - 796	776 - 795	1900	26812	26816	26822
800 x 900	690	370	330	783 - 796	876 - 895	1900	26813	26818	26823
900 x 800	790	420	380	876 - 895	783 - 796	1900	26814	26819	26824
900 x 900	790	420	380	883 - 996	876 - 895	1900	26815	26817	26825
1000 x 700	890	470	430	983 - 996	676 - 695	1900	27554	27555	27553
1000 x 800	890	470	430	983 - 996	783 - 796	1900	-	26820	-
1000 x 900	890	470	430	983 - 996	876 - 895	1900	-	26821	-
1000 x 1000	890	470	430	983 - 996	976 - 995	1900	27561	27562	27560

* All of the ranges can be bumped up by 20 mm if you use a wide wall compensator.

Larenco Corner with Half Height Door & Side Panel

Non-handed Plain Door

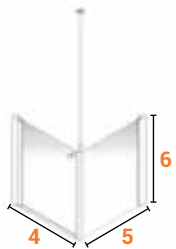
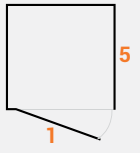

Non-handed Bi-Fold Door

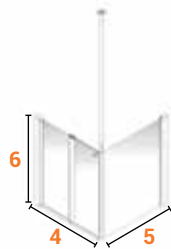
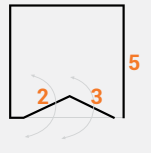

FEATURES

- + Non-handed
- + Suitable for shower trays and wet floors
- + Corner installation
- + One door with a side panel
- + Half height
- + Plain Door and Bi-Fold Door options available
- + Lightweight 6mm toughened safety glass
- + Includes floor to ceiling pole
- + No curtain or rail supplied

Dimensions, Size Options & Product Codes:

Dimensions (lengths) in mm:

Shower Tray Size Options:	1	2	3	4	5	6	Plain Door Code:	Bi-Fold Door Code:
800 x 800	690	370	330	783 - 796	776 - 795	900	26826	26830
800 x 900	690	370	330	783 - 796	876 - 895	900	26828	26832
900 x 800	790	420	380	883 - 996	776 - 795	900	26827	26833
900 x 900	790	420	380	883 - 996	876 - 895	900	26829	26831
1000 x 700	890	470	430	983 - 996	676 - 695	900	27556	27557
1000 x 800	890	470	430	983 - 996	776 - 795	900	-	26834
1000 x 900	890	470	430	983 - 996	876 - 895	900	-	26835
1000 x 1000	890	470	430	983 - 996	976 - 995	900	27563	27564

* All of the ranges can be bumped up by 20 mm if you use a wide wall compensator.

Larenco Corner with Full Height Door, Inline Panel & Side Panel

Non-handed Plain Door

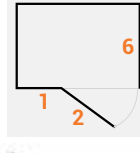

Non-handed Bi-Fold Door

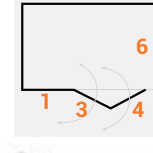

Non-handed Duo Door

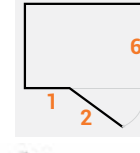

FEATURES

- + Non-handed
- + Suitable for shower trays and wet floors
- + Corner installation
- + One door with an inline panel and a side panel
- + Full height
- + Plain Door, Bi-Fold Door and Duo Door options available
- + Lightweight 6mm toughened safety glass

Dimensions, Size Options & Product Codes:

Dimensions (lengths) in mm:

Shower Tray Size Options:	1	2	3	4	5	6	7	Plain Door Code:	Bi-Fold Door Code:	Duo Door Code:
1200 x 700	417 - 436	690	370	330	1154 - 1186	676 - 695	1900	26862	26865	26868
1200 x 800	417 - 436	690	370	330	1155 - 1186	776 - 795	1900	26863	26866	26869
1200 x 900	417 - 436	690	370	330	1156 - 1186	876 - 895	1900	26864	26867	26870
1300 x 700	417 - 436	790	420	380	1254 - 1286	676 - 695	1900	26877	26880	26883
1300 x 800	417 - 436	790	420	380	1255 - 1286	776 - 795	1900	26878	26878	26884
1300 x 900	417 - 436	790	420	380	1256 - 1286	876 - 895	1900	26879	26882	26885
1400 x 900	417 - 436	890	470	430	1356 - 1386	876 - 895	1900	27583	27584	27582
1500 x 700	417 - 436	-	520	480	1454 - 1486	676 - 695	1900	-	26945	26948
1500 x 800	417 - 436	-	520	480	1455 - 1486	776 - 795	1900	-	26949	26946
1500 x 900	417 - 436	-	520	480	1456 - 1486	876 - 895	1900	-	26947	26950

* All of the ranges can be bumped up by 20 mm if you use a wide wall compensator.

Larenco Corner with Half Height Door, Inline Panel & Side Panel

Non-handed Plain Door

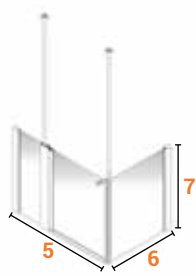
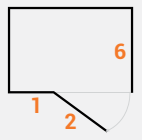

Non-handed Bi-Fold Door

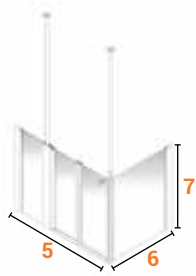
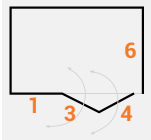

FEATURES

- + Non-handed
- + Suitable for shower trays and wet floors
- + Corner installation
- + One door with an inline panel and a side panel
- + Half height
- + Plain Door and Bi-Fold Door options available
- + Lightweight 6mm toughened safety glass
- + Includes floor to ceiling pole
- + No curtain or rail supplied

Dimensions, Size Options & Product Codes:

Dimensions (lengths) in mm:

Shower Tray Size Options:	1	2	3	4	5	6	7	Plain Door Code:	Bi-Fold Door Code:
1200 x 700	417 - 436	690	370	330	1154 - 1186	676 - 695	900	26871	26874
1200 x 800	417 - 436	690	370	330	1155 - 1186	776 - 795	900	26872	26875
1200 x 900	417 - 436	690	370	330	1156 - 1186	876 - 895	900	26873	26876
1300 x 700	417 - 436	790	420	380	1254 - 1286	676 - 695	900	26886	26889
1300 x 800	417 - 436	790	420	380	1255 - 1286	776 - 795	900	26887	26890
1300 x 900	417 - 436	790	420	380	1256 - 1286	876 - 895	900	26888	26891
1400 x 900	417 - 436	890	470	430	1356 - 1386	876 - 895	900	27585	27586
1500 x 700	417 - 436	-	520	480	1454 - 1486	676 - 695	900	26951	-
1500 x 800	417 - 436	-	520	480	1455 - 1486	776 - 795	900	26952	-
1500 x 900	417 - 436	-	520	480	1456 - 1486	876 - 895	900	26953	-

* All of the ranges can be bumped up by 20 mm if you use a wide wall compensator.

Larenco Corner with Full Height Door, Two Inline Panels & Side Panel

Non-handed Plain Door

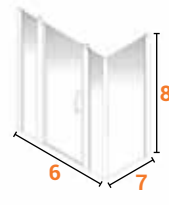
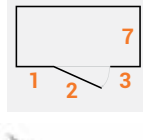

Non-handed Bi-Fold Door

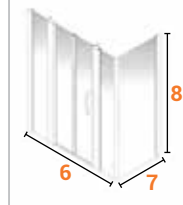
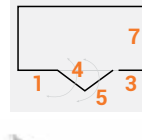

Non-handed Duo Door

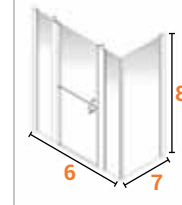
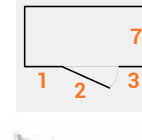

FEATURES

- + Non-handed
- + Suitable for shower trays and wet floors
- + Corner installation
- + One door with two inline panels and a side panel
- + Full height
- + Plain Door, Bi-Fold Door and Duo Door options available
- + Lightweight 6mm toughened safety glass

Dimensions, Size Options & Product Codes:

Dimensions (lengths) in mm:

Shower Tray Size Options:	1	2	3	4	5	6	7	8	Plain Door Code:	Bi-Fold Door Code:	Duo Door Code:
1600 x 700	417 - 436	690	401	370	330	1555 - 1590	682 - 700	1900	26892	26901	26910
1600 x 800	417 - 436	690	401	370	330	1555 - 1590	782 - 800	1900	26893	26902	26911
1600 x 900	417 - 436	690	401	370	330	1555 - 1590	882 - 900	1900	26894	26903	26912
1700 x 700	417 - 436	790	401	420	380	1655 - 1690	682 - 700	1900	26895	26904	26913
1700 x 800	417 - 436	790	401	420	380	1655 - 1690	782 - 800	1900	26896	26905	26914
1700 x 900	417 - 436	790	401	420	380	1655 - 1690	882 - 900	1900	26897	26906	26915
1800 x 700	417 - 436	890	401	470	430	1755 - 1790	682 - 700	1900	26898	26907	26916
1800 x 800	417 - 436	890	401	470	430	1755 - 1790	782 - 800	1900	26899	26908	26917
1800 x 900	417 - 436	890	401	470	430	1755 - 1790	882 - 900	1900	26900	26909	26918

* All of the ranges can be bumped up by 20 mm if you use a wide wall compensator.

Larenco Corner with Half Height Door, Two Inline Panels & Side Panel

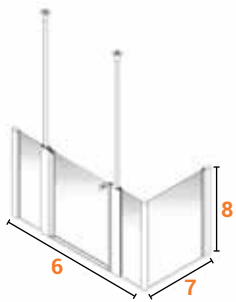
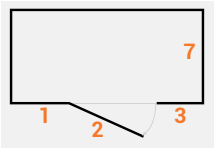
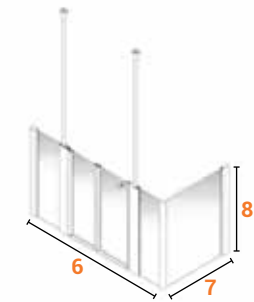
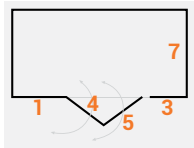
Non-handed
Plain DoorNon-handed
Bi-Fold Door

FEATURES

- + Non-handed
- + Suitable for shower trays and wet floors
- + Corner installation
- + One door with two inline panels and a side panel
- + Half height
- + Plain Door and Bi-Fold Door options available
- + Lightweight 6mm toughened safety glass
- + Includes floor to ceiling pole
- + No curtain or rail supplied

Dimensions, Size Options & Product Codes:

Dimensions (lengths) in mm:

Shower Tray Size Options:	1	2	3	4	5	6	7	8	Plain Door Code:	Bi-Fold Door Code:
1600 x 700	417 - 436	690	401	370	330	1555 - 1590	682 - 700	900	26919	26928
1600 x 800	417 - 436	690	401	370	330	1555 - 1590	782 - 800	900	26920	26929
1600 x 900	417 - 436	690	401	370	330	1555 - 1590	882 - 900	900	26921	26930
1700 x 700	417 - 436	790	401	420	380	1655 - 1690	682 - 700	900	26922	26931
1700 x 800	417 - 436	790	401	420	380	1655 - 1690	782 - 800	900	26923	26932
1700 x 900	417 - 436	790	401	420	380	1655 - 1690	882 - 900	900	26924	26933
1800 x 700	417 - 436	890	401	470	430	1755 - 1790	682 - 700	900	26925	26934
1800 x 800	417 - 436	890	401	470	430	1755 - 1790	782 - 800	900	26926	26935
1800 x 900	417 - 436	890	401	470	430	1755 - 1790	882 - 900	900	26927	26936

* All of the ranges can be bumped up by 20 mm if you use a wide wall compensator.

LEVEL BEST GLASS SHOWER SCREENS

A single wall mounted glass screen that can be used for a wet room or tray installation adding a stylish finish to your bathroom.



Level Best Glass – Option GA

GA

Non-handed

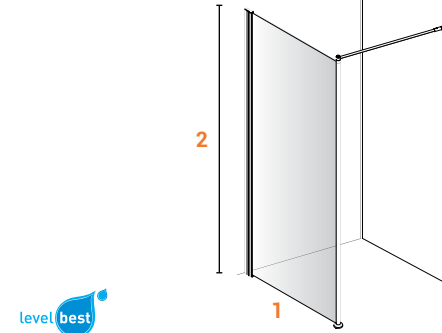

FEATURES

- + Non-handed
- + Screens suitable for all trays and wet floors
- + Single wall mounted glass screen supported by wall brace
- + Stay clear coating on both sides
- + Wall brace supplied 1400mm cut to length



Dimensions, Size Options & Product Codes:

Dimensions (lengths):

Shower Tray Size Options:	1	2	Code:
Will fit most tray sizes*	700mm	1900mm	LB00215
	800mm	1900mm	LB00216
	900mm	1900mm	LB00217
	1000mm	1900mm	LB00218

Accessories:

Accessories:	Code:
1400mm Wall Brace	LB00126

Level Best Screen Black	1	2	Code:
Will fit most trays sizes*	800mm	1900mm	LB00216BK
	900mm	1900mm	LB00217BK
	1000mm	1900mm	LB00218BK

* Tray must be longer than screen ordered

Level Best Glass Deflector Screen

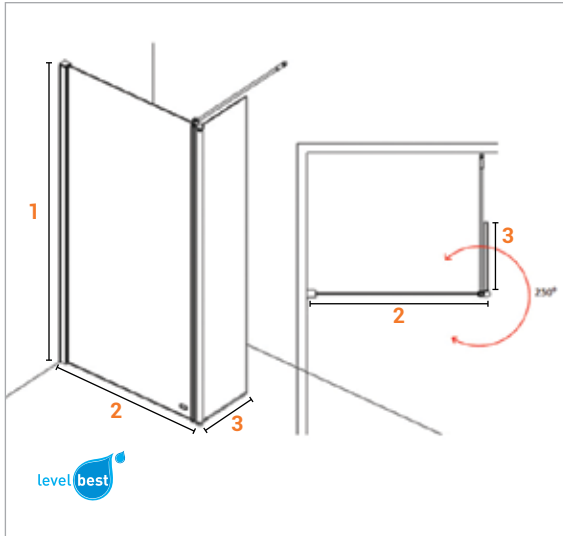

FEATURES

- + Non-handed
- + Screens suitable for all trays and wet floors
- + 1 fixed panel and 1 moving panel (hinge attached)
- + The panel rotates 250° and locks at 55° and 305° from the fixed panel
- + Stay Clear coating on both sides
- + 20mm compensator adjustment on wall fixing
- + Wall brace supplied 1400mm cut to length

Dimensions, Size Options & Product Codes:

Dimensions (lengths):

Shower Tray Size Options:	1	2	3	Code:
Will fit most tray sizes	1900mm	600mm	350mm	27019
	1900mm	700mm	350mm	27020
	1900mm	800mm	350mm	27021
	1900mm	900mm	350mm	27022
	1900mm	1000mm	350mm	27028

Level Best Glass Deflector Screen – Black Screens are not coated	1	2	Code:
Will fit most tray sizes	800mm + 400mm Deflector	1900mm	27018BK
	900mm + 400mm Deflector	1900mm	27031BK
	1000mm + 400mm Deflector	1900mm	27017BK

STANDARD SHOWER SCREENS

All our standard shower screens are designed specifically for the mobility and domestic markets and are both extremely practical and stylish. Screens include 180 degree rising butt hinges and 360 degree bifold hinge.



Standard – Option A

A

Left-handed

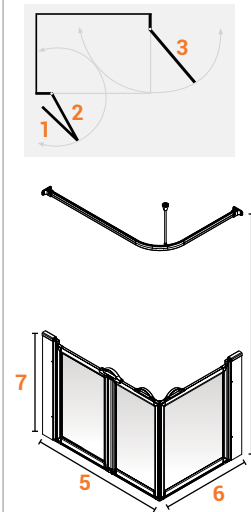

Right-handed

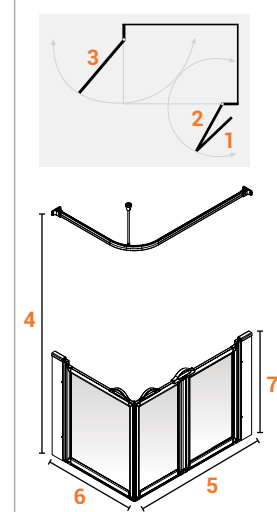

FEATURES

- + Handed
- + Suitable for shower trays
- + Bi-fold door to '1/2' side opening in and out
- + Single door to '3' side opening in and out
- + L-shaped curtain rail supplied
- + Handles are included with Option A screens
- + Drop rod is 600mm
- + Standard 1800mm wide x 1800mm drop shower curtains supplied

Dimensions, Size Options & Product Codes:

Dimensions (lengths):

Shower Tray Size Options:	1	2	3	4	5	6	7	
							750mm	900mm
1000 x 700mm	432mm	477mm	615mm	1880mm	1000mm	700mm	91001L/R	91002L/R
1200 x 700mm	532mm	577mm	615mm	1880mm	1200mm	700mm	91003L/R	91004L/R
1200 x 760mm	532mm	577mm	615mm	1880mm	1200mm	760mm	91188L/R	91189L/R
1300 x 700mm	582mm	627mm	615mm	1880mm	1300mm	700mm	91005L/R	91006L/R
1250 x 750mm	532mm	577mm	615mm	1880mm	1250mm	750mm	91190L/R	91191L/R
1350 x 750mm	582mm	627mm	615mm	1880mm	1350mm	750mm	91192L/R	91193L/R

■ Sizes shown are maximum achieved with a 50mm compensator, the screens are 50mm shorter

L/R in the product code denotes whether the screen is Left or Right handed.

Standard – Option B

B

Left-handed

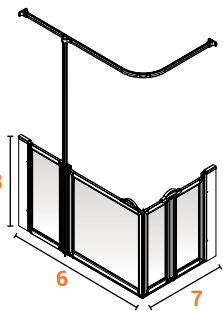
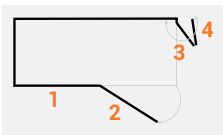

Right-handed

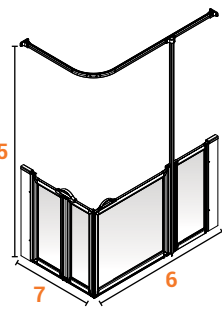
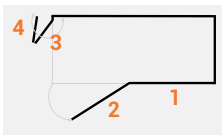

FEATURES

- + Handed
- + Suitable for shower trays
- + Side panel with single door to '6' side opening in and out
- + Bi-fold doors to '7' side opening in and out
- + L-shaped curtain rail supplied
- + Handles are included with Option B screens
- + Standard 1800mm wide x 1800mm drop shower curtains supplied

Dimensions, Size Options & Product Codes:

Dimensions (lengths):

Shower Tray Size Options:	1	2	3	4	5	6	7	8	
								750mm	900mm
1200 x 700mm	412mm	749mm	327mm	282mm	1880mm	1200mm	700mm	91007L/R	91009L/R
1200 x 760mm	412mm	749mm	327mm	282mm	1880mm	1200mm	760mm	91194L/R	91195L/R
1200 x 820mm	412mm	749mm	387mm	342mm	1880mm	1200mm	820mm	91008L/R	91010L/R
1300 x 700mm	692mm	565mm	327mm	282mm	1880mm	1300mm	700mm	91168L/R	91169L/R
1420 x 700mm	692mm	685mm	327mm	282mm	1880mm	1420mm	700mm	91013L/R	91015L/R
1420 x 820mm	692mm	685mm	387mm	342mm	1880mm	1420mm	820mm	91014L/R	91016L/R
1500 x 700mm	764mm	693mm	327mm	282mm	1880mm	1500mm	700mm	91017L/R	91019L/R
1700 x 700mm	810mm	847mm	327mm	282mm	1880mm	1700mm	700mm	91021L/R	91022L/R
1250 x 750mm	462mm	749mm	327mm	282mm	1880mm	1250mm	750mm	91196L/R	91197L/R
1470 x 750mm	742mm	685mm	327mm	282mm	1880mm	1470mm	750mm	91198L/R	91199L/R

■ Screens only suitable for Pipe Duct trays

Please note: 760mm tray is achieved with extra wide compensator. Compensators are set at mid point giving 14.5mm in and out adjustment on both sides.

L/R in the product code denotes whether the screen is Left or Right handed.

Standard – Option BF

BF

Non-handed

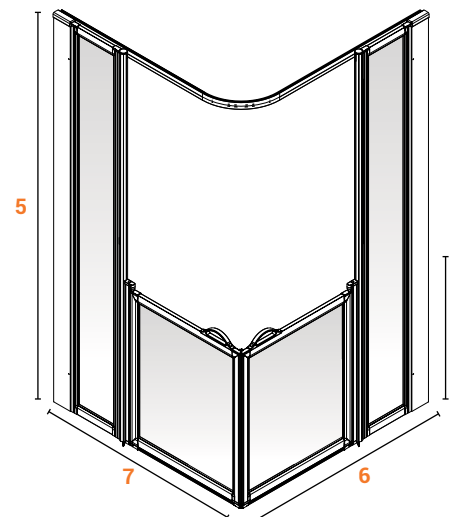
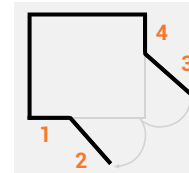

FEATURES

- + Non-handed
- + Suitable for shower trays
- + Bi-parting doors to '6' and '7' sides, opening in and out
- + Full height
- + L-shaped curtain rail supplied
- + Handles are included with Option BF screens
- + Standard 1800mm wide x 1800mm drop shower curtains supplied

Dimensions, Size Options & Product Codes:

Dimensions (lengths):

Shower Tray Size Options:	1	2	3	4	5	6	7	8	
								750mm	900mm
1000 x 1000mm	500mm	457mm	457mm	500mm	1880mm	1000mm	1000mm	91023N	91024N
1050 x 1050mm	550mm	457mm	457mm	550mm	1880mm	1050mm	1050mm	91200N	91201N

■ Screens only suitable for Pipe Duct trays

Please note: Compensators are set at mid point giving 14.5mm in and out adjustment on both sides.

Please note: If you require a different size screen, poles or curtain we can accommodate this. Please refer to Made-to-Measure Screens on page 154

Standard – Option C C

Left-handed

Right-handed

FEATURES

- + Handed
- + Suitable for shower trays
- + Bi-parting doors to '4' side opening in and out with fixed panel to '5' side
- + L-shaped curtain rail supplied
- + Handles are an optional extra
- + Standard 1800mm wide x 1800mm drop shower curtains supplied

Dimensions, Size Options & Product Codes:

Dimensions (lengths):

Shower Tray Size Options:	1	2	3	4	5	6	
						750mm	900mm
1000 x 700mm	453mm	453mm	1880mm	1000mm	700mm	91025L/R	91027L/R
1000 x 1000mm	453mm	453mm	1880mm	1000mm	1000mm	91026L/R	91028L/R
1200 x 650mm	553mm	553mm	1880mm	1200mm	650mm	91029L/R	91032L/R
1200 x 700mm	553mm	553mm	1880mm	1200mm	700mm	91030L/R	91033L/R
1200 x 760mm	553mm	553mm	1880mm	1200mm	760mm	91204L/R	91205L/R
1200 x 820mm	553mm	553mm	1880mm	1200mm	820mm	91031L/R	91034L/R
1300 x 700mm	603mm	603mm	1880mm	1300mm	700mm	91035L/R	91037L/R
1300 x 820mm	603mm	603mm	1880mm	1300mm	820mm	91036L/R	91038L/R
1050 x 1050mm	453mm	453mm	1880mm	1050mm	1050mm	91202L/R	91203L/R
1250 x 750mm	553mm	553mm	1880mm	1250mm	750mm	91206L/R	91207L/R
1350 x 750mm	603mm	603mm	1880mm	1300mm	750mm	91208L/R	91209L/R

■ Screens only suitable for Pipe Duct trays

Please note: 760mm tray is achieved with extra wide compensator. Compensators are set at mid point giving 14.5mm in and out adjustment on both sides.

L/R in the product code denotes whether the screen is Left or Right handed.

Standard – Option D D

Left-handed

Right-handed

FEATURES

- + Handed
- + Suitable for shower trays
- + Folding doors and fixed panel to '4' side and fixed panel '5' side
- + L-shaped curtain rail supplied
- + Handles are an optional extra
- + Standard 1800mm wide x 1800mm drop shower curtains supplied

Dimensions, Size Options & Product Codes:

Dimensions (lengths):

Shower Tray Size Options:	1	2	3	4	5	6	7	
							750mm	900mm
1200 x 700mm	374mm	339mm	398mm	1200mm	700mm	1880mm	91039L/R	91040L/R
1200 x 760mm	374mm	339mm	398mm	1200mm	760mm	1880mm	91210L/R	91211L/R
1300 x 700mm	424mm	389mm	398mm	1300mm	700mm	1880mm	91388L/R	91388L/R
1250 x 750mm	374mm	339mm	398mm	1250mm	750mm	1880mm	91212L/R	91213L/R

■ Screens only suitable for Pipe Duct trays

Please note: 760mm tray is achieved with extra wide compensator. Compensators are set at mid point giving 14.5mm in and out adjustment on both sides.

L/R in the product code denotes whether the screen is Left or Right handed.

Please note: If you require a different size screen, poles or curtain we can accommodate this. Please refer to Made-to-Measure Screens on page 154

Standard – Option E

E

Left-handed

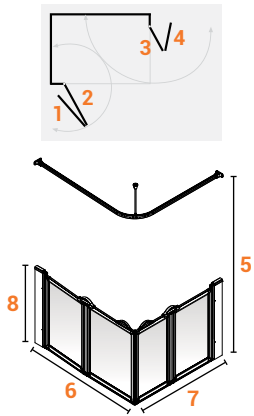

Right-handed

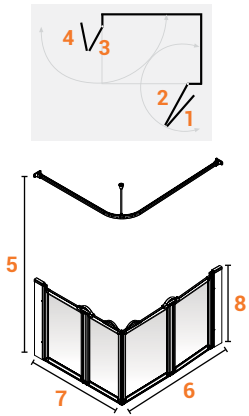

FEATURES

- + Handed & Non-handed
- + Suitable for shower trays
- + Bi-fold doors to '6' and '7' sides
- + L-shaped curtain rail supplied
- + Handles are included with Option E screens
- + Standard 1800mm wide x 1800mm drop shower curtains supplied

Dimensions, Size Options & Product Codes:

Dimensions (lengths):

Shower Tray Size Options:	1	2	3	4	5	6	7	8	
								750mm	900mm
800 x 800mm	332mm	377mm	377mm	332mm	1880mm	800mm	800mm	91041N	91042N
820 x 820mm	342mm	387mm	387mm	342mm	1880mm	820mm	820mm	91043N	91044N
900 x 900mm	382mm	427mm	427mm	382mm	1880mm	900mm	900mm	91045N	91046N
1000 x 700mm	432mm	477mm	327mm	282mm	1880mm	1000mm	700mm	91047L/R	91049L/R
1000 x 1000mm	432mm	477mm	477mm	432mm	1880mm	1000mm	1000mm	91048N	91050N
1000 x 800mm	432mm	477mm	377mm	332mm	1880mm	1000mm	800mm	91319L/R	91320L/R
1200 x 700mm	532mm	577mm	327mm	282mm	1880mm	1200mm	700mm	91053L/R	91057L/R
1200 x 760mm	532mm	577mm	327mm	282mm	1880mm	1200mm	760mm	91216L/R	91217L/R
1200 x 820mm	532mm	577mm	387mm	342mm	1880mm	1200mm	820mm	91054L/R	91058L/R
1200 x 900mm	532mm	577mm	427mm	382mm	1880mm	1200mm	900mm	91056L/R	91060L/R
1300 x 700mm	582mm	627mm	327mm	282mm	1880mm	1300mm	700mm	91061L/R	91063L/R
1300 x 820mm	582mm	627mm	387mm	342mm	1880mm	1300mm	820mm	91062L/R	91064L/R
1050 x 1050mm	432mm	477mm	477mm	432mm	1880mm	1050mm	1050mm	91214N	91215N
1250 x 750mm	532mm	577mm	327mm	282mm	1880mm	1250mm	750mm	91218L/R	91219L/R
1350 x 750mm	382mm	627mm	327mm	282mm	1880mm	1350mm	750mm	91220L/R	91221L/R

■ Screens only suitable for Pipe Duct trays

Please note: Compensators are set at mid point giving 14.5mm in and out adjustment on one side. Screen width needs to be less than the length of the tray and provide adequate access for user.

Standard – Option E5

E5

Left-handed

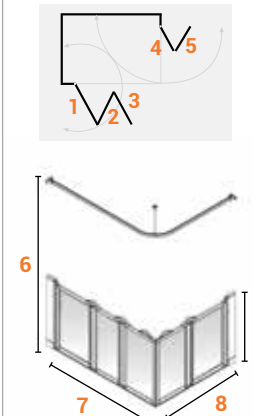

Right-handed

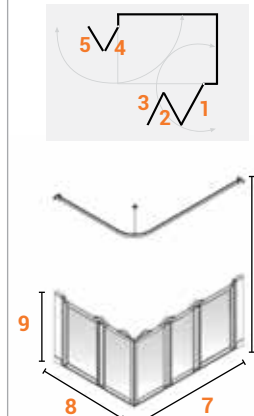

FEATURES

- + Handed
- + Suitable for shower trays
- + Tri-fold doors to '7' and bi-fold doors to '8' sides
- + L-shaped curtain rail supplied
- + Handles are included with Option E screens
- + Standard 1800mm wide x 1800mm drop shower curtains supplied

Dimensions, Size Options & Product Codes:

Dimensions (lengths):

Shower Tray Size Options:	1	2	3	4	5	6	7	8	9
									750mm
820 x 1200mm	390mm	373mm	345mm	387mm	342mm	1880mm	1200mm	820mm	91381L/R
820 x 1300mm	424mm	406mm	279mm	387mm	342mm	1880mm	1300mm	820mm	91382L/R
900 x 1400mm	457mm	439mm	412mm	427mm	382mm	1880mm	1400mm	900mm	91383L/R

Please note: Compensators are set at mid point giving 14.5mm in and out adjustment on one side. Screen width needs to be less than the length of the tray and provide adequate access for user.

L/R in the product code denotes whether the screen is Left or Right handed.

Please note: If you require a different size screen, poles or curtain we can accommodate this. Please refer to Made-to-Measure Screens on page 154

Standard – Option H H

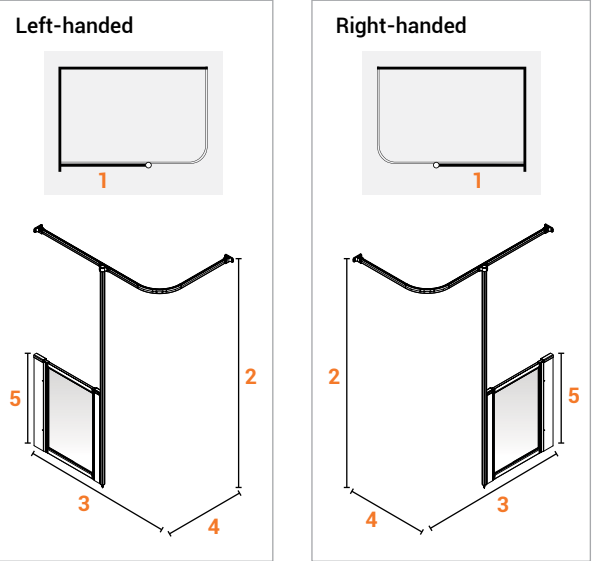

- FEATURES**
- + Handed
 - + Suitable for shower trays
 - + Fits most tray sizes LH and RH
 - + L-shaped curtain rail supplied
 - + 1x 1400mm and 1x 1900mm drop curtains supplied

Dimensions, Size Options & Product Codes:

Dimensions (lengths):

Shower Tray Size Options:	1*	2	3	4	5	
					750mm	900mm
Will fit most tray sizes	600mm	1880mm	Will fit most tray sizes	Will fit most tray sizes	91069L/R	91074L/R
	700mm	1880mm			91070L/R	91075L/R
	800mm	1880mm			91071L/R	91076L/R
	900mm	1880mm			91072L/R	91077L/R
	1000mm	1880mm			91073L/R	91078L/R
	650mm	1880mm			91222L/R	91223L/R
	750mm	1880mm			91224L/R	91225L/R
	850mm	1880mm			91226L/R	91227L/R
	950mm	1880mm			91228L/R	91229L/R
	1050mm	1880mm			91231L/R	91230L/R

■ Screens only suitable for Pipe Duct trays

Please note: Compensators are set at mid point giving 14.5mm in and out adjustment on one side. Screen width needs to be less than the length of the tray and provide adequate access for user.

*Column 1: Includes 32mm post.

L/R in the product code denotes whether the screen is Left or Right handed.

Standard – Option HF HF

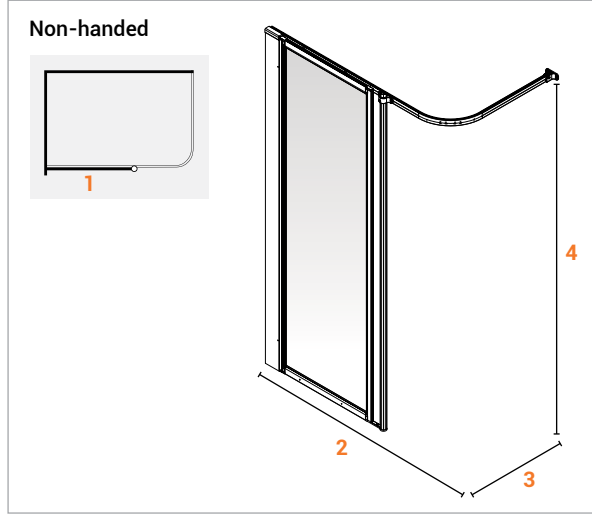

- FEATURES**
- + Non-handed
 - + Suitable for shower trays
 - + Full height
 - + Fits all tray sizes LH and RH
 - + L-shaped curtain rail supplied
 - + 1 x 1900mm drop curtain supplied

Dimensions, Size Options & Product Codes:

Dimensions (lengths):

Shower Tray Size Options:	1*	2	3	4	Code:
Will fit all tray sizes	600mm	Will fit all tray sizes	Will fit all tray sizes	1880mm	91079N
	700mm			1880mm	91080N
	800mm			1880mm	91081N
	900mm			1880mm	91082N
	1000mm			1880mm	91083N
	650mm			1880mm	91242N
	750mm			1880mm	91243N
	850mm			1880mm	91244N
	950mm			1880mm	91245N
	1050mm			1880mm	91246N
600mm			1880mm	91387N	

■ Screens only suitable for Pipe Duct trays

□ Model features a straight rail rather than curved

Please note: Compensators are set at mid point giving 14.5mm in and out adjustment on one side. Screen width needs to be less than the length of the tray and provide adequate access for user.

*Column 1: Includes 55mm gap and 32mm post.

Standard – Option J J

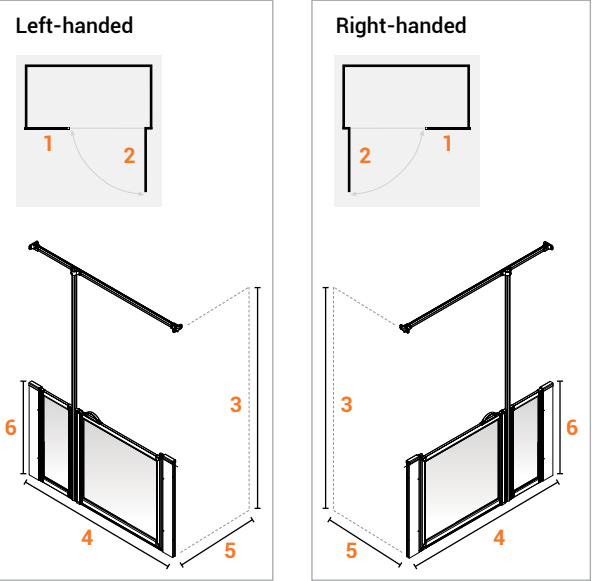

- FEATURES**
- + Handed
 - + Suitable for shower trays
 - + Fixed panel with single door opening out only
 - + Curtain rail L-shaped, can be cut to fit straight
 - + Handles are included with Option J screens
 - + Standard 1800mm wide x 1800mm drop shower curtains supplied

Dimensions, Size Options & Product Codes:

Dimensions (lengths):

Shower Tray Size Options:	1	2	3	4	5	6	
						750mm	900mm
1300mm	417mm	799mm	1880mm	1300mm	700mm	91084L/R	91085L/R
1420mm	537mm	799mm	1880mm	1420mm	700mm	91086L/R	91087L/R
1700mm	755mm	861mm	1880mm	1700mm	700mm	91088L/R	91089L/R
1350mm	467mm	799mm	1880mm	1350mm	750mm	91252L/R	91253L/R
1470mm	587mm	799mm	1880mm	1470mm	750mm	91254L/R	91255L/R

Screens only suitable for Pipe Duct trays

Please note: Compensators are set at mid point giving 14.5mm in and out adjustment on both sides.

L/R in the product code denotes whether the screen is Left or Right handed.

Standard – Option K K

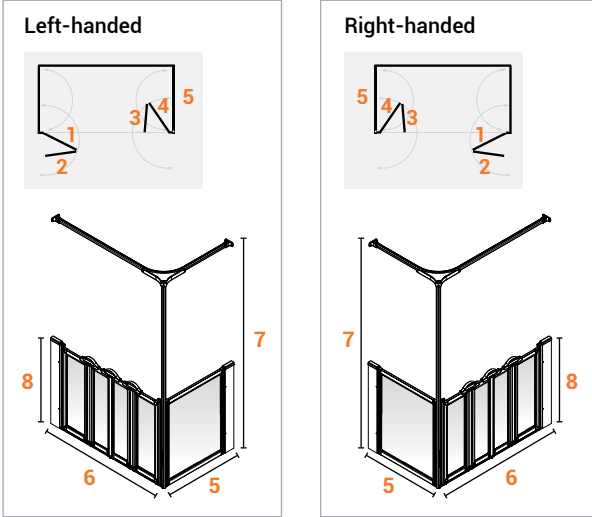

- FEATURES**
- + Handed
 - + Suitable for shower trays
 - + Double bi-fold doors to '6' side opening in and out
 - + Fixed side panel to '5'
 - + L-shaped curtain rail supplied
 - + Handles are included with Option K screens
 - + Standard 1800mm wide x 1800mm drop shower curtains supplied

Dimensions, Size Options & Product Codes:

Dimensions (lengths):

Shower Tray Size Options:	1	2	3	4	5	6	7	8	
								750mm	900mm
1200 x 650mm	295mm	260mm	260mm	295mm	650mm	1200mm	1880mm	91090L/R	91092L/R
1200 x 700mm	295mm	260mm	260mm	295mm	700mm	1200mm	1880mm	91091L/R	91093L/R
1200 x 760mm	295mm	260mm	260mm	295mm	760mm	1200mm	1880mm	91256L/R	91257L/R
1420 x 700mm	350mm	315mm	315mm	350mm	700mm	1420mm	1880mm	91094L/R	91096L/R
1420 x 820mm	350mm	315mm	315mm	350mm	820mm	1420mm	1880mm	91095L/R	91097L/R
1700 x 700mm	420mm	385mm	385mm	420mm	700mm	1700mm	1880mm	91098L/R	91099L/R
1250 x 750mm	295mm	260mm	260mm	295mm	750mm	1250mm	1880mm	91258L/R	91259L/R
1470 x 750mm	350mm	315mm	315mm	350mm	750mm	1470mm	1880mm	91260L/R	91261L/R

Screens only suitable for Pipe Duct trays

Please note: 760mm tray is achieved with extra wide compensator. Compensators are set at mid point giving 14.5mm in and out adjustment on both sides.

L/R in the product code denotes whether the screen is Left or Right handed.

Please note: If you require a different size screen, poles or curtain we can accommodate this. Please refer to Made-to-Measure Screens on page 154

Standard – Option M M

Non-handed

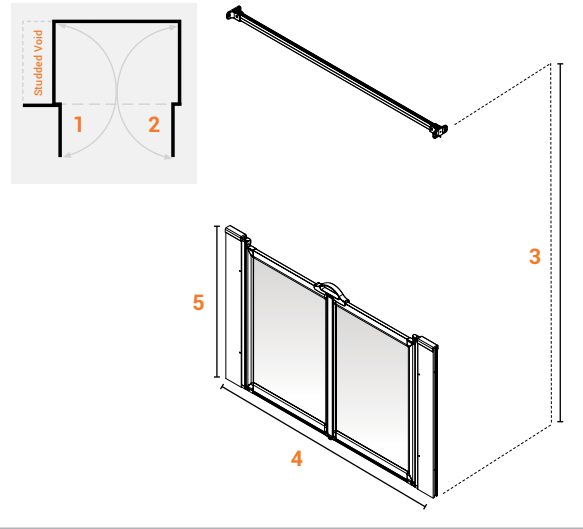

FEATURES

- + Non-handed
- + Suitable for shower trays
- + Bi-parting doors opening in and out
- + L-shaped curtain rail supplied – can be trimmed on site
- + Latch included (additional handles are optional extras)
- + Standard 1800mm wide x 1800mm drop shower curtains supplied

Dimensions, Size Options & Product Codes:

Dimensions (lengths):

Shower Tray Size Options:	1	2	3	4	5	
					750mm	900mm
800mm	347mm	347mm	1880mm	800mm	91104N	91109N
900mm	397mm	397mm	1880mm	900mm	91100N	91105N
1000mm	447mm	447mm	1880mm	1000mm	91101N	91106N
1200mm	547mm	547mm	1880mm	1200mm	91102N	91107N
1300mm	597mm	597mm	1880mm	1300mm	91103N	91108N
1050mm	447mm	447mm	1880mm	1050mm	91262N	91263N
1250mm	547mm	547mm	1880mm	1250mm	91264N	91265N
1350mm	597mm	597mm	1880mm	1350mm	91266N	91267N

■ Screens only suitable for Pipe Duct trays

Please note: Compensators are set at mid point giving 14.5mm in and out adjustment on both sides.

Standard – Option N N

Non-handed

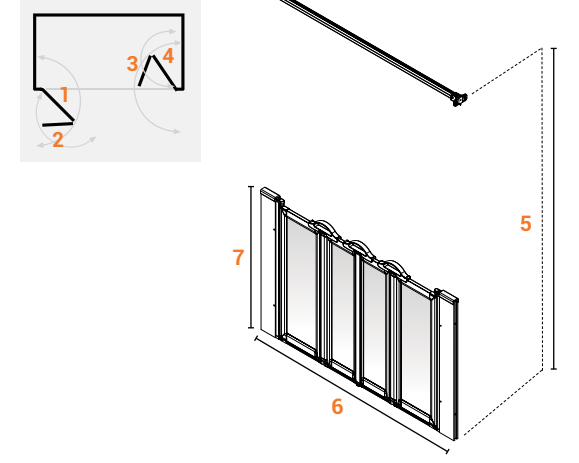

FEATURES

- + Non-handed
- + Suitable for shower trays
- + Twin bi-folding doors, opening in and out
- + L-shaped curtain rail supplied – can be trimmed on site
- + Latches are included with Option N screens
- + Standard 1800mm wide x 1800mm drop shower curtains supplied

Dimensions, Size Options & Product Codes:

Dimensions (lengths):

Shower Tray Size Options:	1	2	3	4	5	6	7	
							750mm	900mm
1200mm	292mm	257mm	257mm	292mm	1880mm	1200mm	91110N	91118N
1300mm	317mm	282mm	282mm	317mm	1880mm	1300mm	91111N	91119N
1420mm	347mm	312mm	312mm	347mm	1880mm	1420mm	91113N	91121N
1500mm	367mm	332mm	332mm	367mm	1880mm	1500mm	91114N	91122N
1600mm	392mm	357mm	357mm	392mm	1880mm	1600mm	–	91321N
1700mm	417mm	382mm	382mm	417mm	1880mm	1700mm	91117N	91124N
1250mm	292mm	257mm	257mm	292mm	1880mm	1250mm	91268N	91269N
1350mm	317mm	282mm	282mm	317mm	1880mm	1350mm	91270N	91271N
1470mm	347mm	312mm	312mm	347mm	1880mm	1470mm	91272N	91273N

■ Screens only suitable for Pipe Duct trays

Please note: Compensators are set at mid point giving 14.5mm in and out adjustment on both sides.

Please note: If you require a different size screen, poles or curtain we can accommodate this. Please refer to Made-to-Measure Screens on page 154

Standard – Option P P

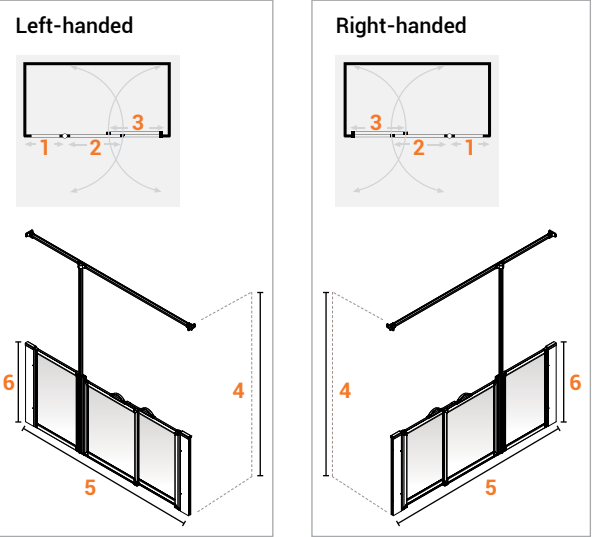

- FEATURES**
- + Handed
 - + Suitable for shower trays
 - + Fixed side panel '1', overlapping doors '2/3'
 - + Straight curtain rail supplied
 - + Handles are included with Option P screens
 - + Standard 1800mm wide x 1800mm drop shower curtains supplied

Dimensions, Size Options & Product Codes:

Dimensions (lengths):

Shower Tray Size Options:	1	2	3	4	5	6	
						750mm	900mm
1800mm	560mm	560mm	641mm	1880mm	1500-1800mm	91125L/R	91126L/R
1850 x 750mm	610mm	629mm	641mm	1880mm	1550-1850mm	91274L/R	91275L/R

Screens only suitable for Pipe Duct trays

Please note: Compensators are set at mid point giving 14.5mm in and out adjustment on both sides.

***Column 5:** measurements account for adjustment with overlapping doors. Overlapping doors enable the Option P screen set to be adjusted on site to accommodate different alcove widths. This avoids the need for accurate pre-measurement and specially made screens.

L/R in the product code denotes whether the screen is Left or Right handed.

Standard – Option Q Q

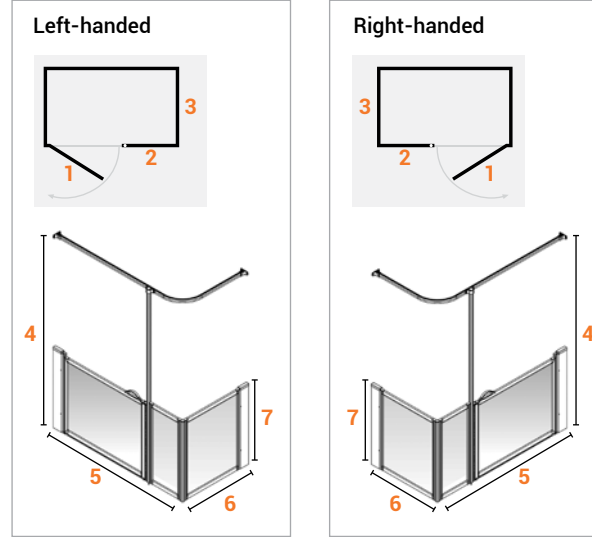

- FEATURES**
- + Handed
 - + Suitable for shower trays
 - + Folding doors and fixed panel to '5' side and fixed panel '6' side
 - + L-shaped curtain rail supplied
 - + Handles are included with Option Q screens
 - + Standard 1800mm wide x 1800mm drop shower curtains supplied

Dimensions, Size Options & Product Codes:

Dimensions (lengths):

Shower Tray Size Options:	1	2	3	4	5	6	7	
							750mm	900mm
1300 x 700mm	862mm	342mm	694mm	1880mm	1300mm	700mm	91335L/R	–
1420 x 700mm	862mm	462mm	694mm	1880mm	1420mm	700mm	91336L/R	–

Please note: Compensators are set at mid point giving 14.5mm in and out adjustment on both sides.

L/R in the product code denotes whether the screen is Left or Right handed.

Please note: If you require a different size screen, poles or curtain we can accommodate this. Please refer to Made-to-Measure Screens on page 154

Standard – Option TT

TT

Left-handed

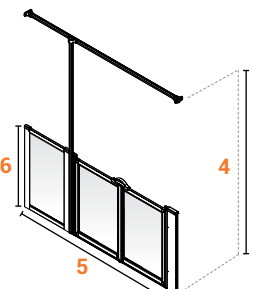
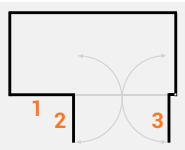

Right-handed

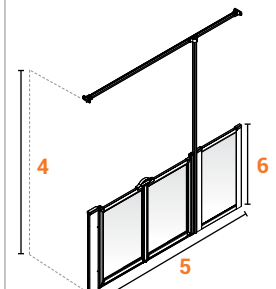
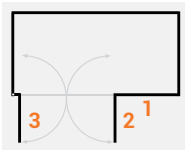

FEATURES

- + Handed
- + Suitable for shower trays
- + Trimmable panel with bi-parting doors, opening in and out
- + Straight curtain rail supplied
- + Latch included (additional handles are optional extras)
- + Standard 1800mm wide x 1800mm drop shower curtains supplied

Dimensions, Size Options & Product Codes:

Dimensions (lengths):

Shower Tray Size Options:	1*	2	3	4	5**	6	
						750mm	900mm
1500-1800mm	685-385mm	517mm	517mm	1880mm	1500-1800mm	91127L/R	91128L/R

Please note: Compensators are set at mid point giving 14.5mm in and out adjustment on door side only. Option TT screens can be used with Pipe Ducted trays on door side only. All options Patented GB 2429030.

*Column 1: maximum size of trimmable panel.

**Column 5: measurements account for adjustment (on door side only) with trimmable panel.

Option TT screen, handed, with bi-parting doors to give 900mm clear entry path, opening in and out. Fixed panel is trimmable on-site to suit alcove situations.

L/R in the product code denotes whether the screen is Left or Right handed.

Standard – Option U

U

Left-handed

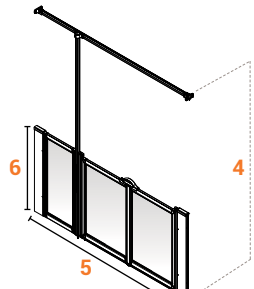
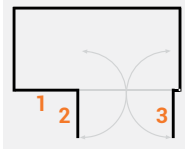

Right-handed

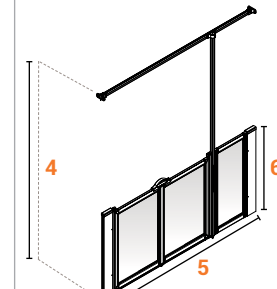
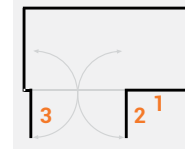

FEATURES

- + Handed
- + Suitable for shower trays
- + Fixed panel with bi-parting doors, opening in and out
- + L-shaped curtain rail supplied – can be trimmed on site
- + Latches are included with Option U screens
- + Standard 1800mm wide x 1800mm drop shower curtains supplied

Dimensions, Size Options & Product Codes:

Dimensions (lengths):

Shower Tray Size Options:	1	2	3	4	5	6	
						750mm	900mm
1300mm	422mm	411mm	411mm	1880mm	1300mm	91129L/R	91131L/R
1420mm	485mm	439mm	439mm	1880mm	1420mm	91130L/R	91132L/R
1350mm	472mm	411mm	411mm	1880mm	1350mm	91276L/R	91277L/R
1470mm	535mm	439mm	439mm	1880mm	1470mm	91278L/R	91279L/R

■ Screens only suitable for Pipe Duct trays

Please note: Compensators are set at mid point giving 14.5mm in and out adjustment on both sides.

L/R in the product code denotes whether the screen is Left or Right handed.

Please note: If you require a different size screen, poles or curtain we can accommodate this. Please refer to Made-to-Measure Screens on page 154

Standard – Option X X

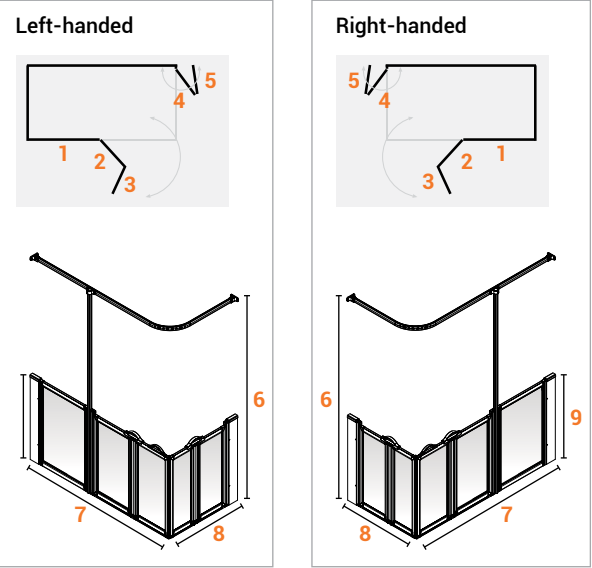

- FEATURES**
- + Handed
 - + Suitable for shower trays
 - + Fixed side panel on '7' and bi-folding doors on '7' and '8', opening in and out
 - + L-shaped curtain rail supplied
 - + Handles are included with Option X screens
 - + Standard 1800mm wide x 1800mm drop shower curtains supplied

Dimensions, Size Options & Product Codes:

Dimensions (lengths):

Shower Tray Size Options:	1	2	3	4	5	6	7	8	9	
									750mm	900mm
1200 x 700mm	422mm	369mm	324mm	320mm	365mm	1880mm	1200mm	700mm	91318L/R	91133L/R
1300 x 700mm	522mm	369mm	324mm	320mm	365mm	1880mm	1300mm	700mm	91389L/R	91135L/R
1420 x 700mm	692mm	366mm	321mm	327mm	282mm	1880mm	1420mm	700mm	91137L/R	91139L/R
1420 x 820mm	692mm	366mm	321mm	387mm	342mm	1880mm	1420mm	820mm	91138L/R	91140L/R
1500 x 700mm	692mm	406mm	361mm	327mm	282mm	1880mm	1500mm	700mm	91141L/R	91143L/R
1470 x 750mm	742mm	366mm	321mm	327mm	282mm	1880mm	1470mm	750mm	91280L/R	91281L/R

■ Screens only suitable for Pipe Duct trays

Please note: Compensators are set at mid point giving 14.5mm in and out adjustment on both sides.

L/R in the product code denotes whether the screen is Left or Right handed.

Standard – Option XF XF

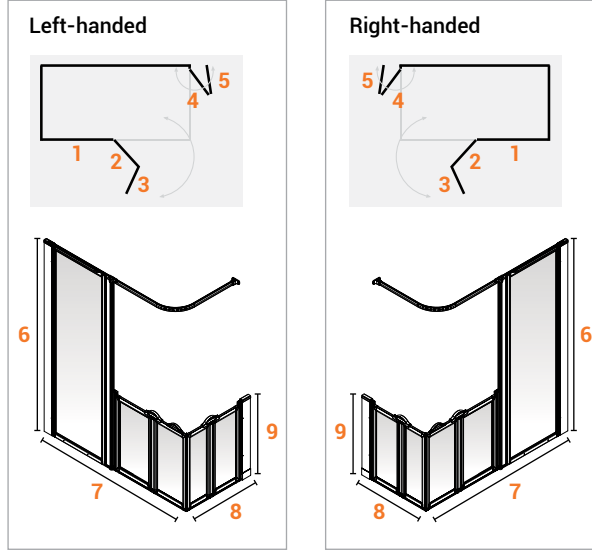

- FEATURES**
- + Handed
 - + Suitable for shower trays
 - + Full height
 - + Fixed side panel on '7' and bi-folding doors on '7' and '8', opening in and out
 - + L-shaped curtain rail supplied
 - + Handles are included with Option XF screens
 - + Standard 1800mm wide x 1800mm drop shower curtains supplied

Dimensions, Size Options & Product Codes:

Dimensions (lengths):

Shower Tray Size Options:	1	2	3	4	5	6	7	8	9	
									750mm	900mm
1800 x 700mm	800mm	498mm	460mm	323mm	285mm	1880mm	1800mm	700mm	91339L/R	
1800 x 820mm	800mm	498mm	460mm	383mm	345mm	1880mm	1800mm	820mm	91340L/R	

Please note: Compensators are set at mid point giving 14.5mm in and out adjustment on both sides.

L/R in the product code denotes whether the screen is Left or Right handed.

Please note: If you require a different size screen, poles or curtain we can accommodate this. Please refer to Made-to-Measure Screens on page 154

Standard – Option Y

Y

Left-handed

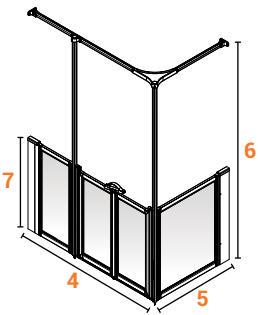
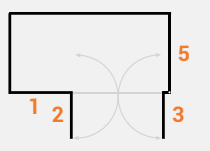

Right-handed

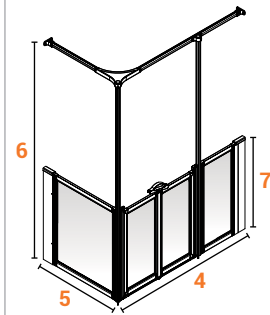
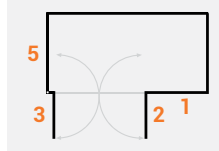

FEATURES

- + Handed
- + Suitable for shower trays
- + Fixed side panel and bi-parting doors to '4' side
- + Fixed side panel to '5' side
- + L-shaped curtain rail supplied
- + Latch included (additional handles are optional extras)
- + Standard 1800mm wide x 1800mm drop shower curtains supplied

Dimensions, Size Options & Product Codes:

Dimensions (lengths):

Shower Tray Size Options:	1	2	3	4	5	6	7	
							750mm	900mm
1300 x 700mm	381mm	437mm	437mm	1300mm	700mm	1880mm	91145L/R	91147L/R
1300 x 820mm	381mm	437mm	437mm	1300mm	820mm	1880mm	91146L/R	91148L/R
1420 x 700mm	500mm	437mm	437mm	1420mm	700mm	1880mm	91149L/R	91151L/R
1420 x 820mm	500mm	437mm	437mm	1420mm	820mm	1880mm	91150L/R	91152L/R
1700 x 700mm	702mm	477mm	477mm	1700mm	700mm	1880mm	91153L/R	91154L/R
1350 x 750mm	431mm	437mm	437mm	1350mm	750mm	1880mm	91282L/R	91283L/R
1470 x 750mm	550mm	437mm	437mm	1470mm	750mm	1880mm	91284L/R	91285L/R

■ Screens only suitable for Pipe Duct trays

Please note: Compensators are set at mid point giving 14.5mm in and out adjustment on both sides.

L/R in the product code denotes whether the screen is Left or Right handed.

Standard – Option YF

YF

Left-handed

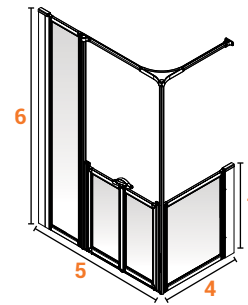
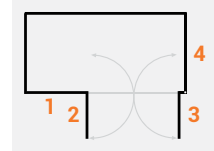

Right-handed

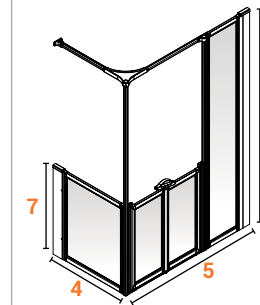
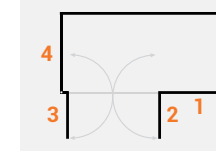

FEATURES

- + Handed
- + Suitable for shower trays
- + Full height
- + Fixed side panel and bi-parting doors to '5' side
- + Fixed side panel to '4' side
- + L-shaped curtain rail supplied
- + Handles are an optional extra
- + Standard 1800mm wide x 1800mm drop shower curtains supplied

Dimensions, Size Options & Product Codes:

Dimensions (lengths):

Shower Tray Size Options:	1	2	3	4	5	6	7
							750mm
1800 x 700mm	800mm	469mm	469mm	700mm	1800mm	1880mm	91341L/R
1800 x 820mm	800mm	469mm	469mm	820mm	1800mm	1880mm	91342L/R

Please note: Compensators are set at mid point giving 14.5mm in and out adjustment on both sides.

L/R in the product code denotes whether the screen is Left or Right handed.

Please note: If you require a different size screen, poles or curtain we can accommodate this. Please refer to Made-to-Measure Screens on page 154

Standard – Option Z

Z

Left-handed

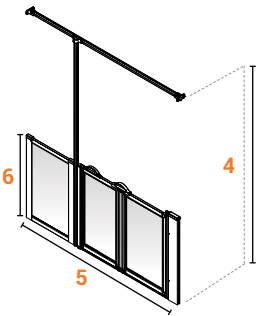
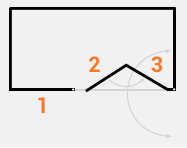

Right-handed

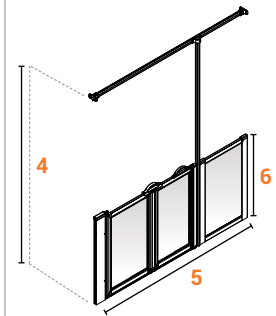
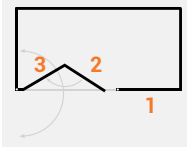

FEATURES

- + Handed
- + Suitable for shower trays
- + Bi-folding doors '2/3' to give 900mm clear entry path, opening in and out
- + Fixed panel '1' is trimmable on site to suit alcove situations
- + Straight curtain rail supplied
- + Latches are included with Option Z screens
- + Standard 1800mm wide x 1800mm drop shower curtains supplied

Dimensions, Size Options & Product Codes:

Dimensions (lengths):

Shower Tray Size Options:	1*	2	3	4	5**	6	
						750mm	900mm
1500-1800mm	410mm	483mm	518mm	1880mm	1500-1800mm	91155L/R	91156L/R
1850mm	410mm	483mm	518mm	1880mm	1850mm	91286L/R	91287L/R

■ Screens only suitable for Pipe Duct trays

Please note: Compensators are set at mid point giving 14.5mm in and out adjustment on both sides. **Option Z screens can be used with pipe duct kits on door side only.**

*Column 1: maximum size of trimmable panel.

**Column 5: measurements account for adjustment (on door side only) with trimmable panel.

L/R in the product code denotes whether the screen is Left or Right handed.

STANDARD WET FLOOR SHOWER SCREENS

All of our **wet floor** screens can be installed with a variety of shower configurations and have strong carefully designed seals to reduce water egress. Screens include 180 degree rising butt hinges and 360 degree bifold hinge.



Standard Wet Floor – Option BW

BW

Left-handed

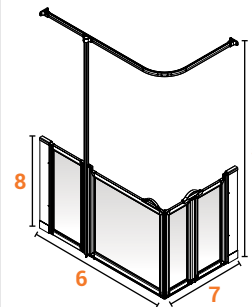
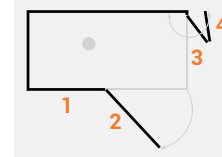

Right-handed

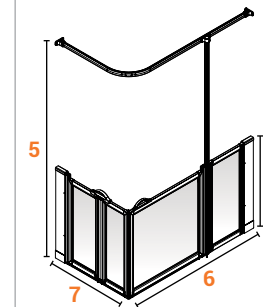
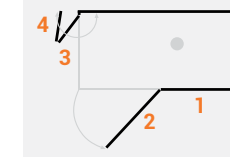

FEATURES

- + Handed
- + Suitable for wet floors
- + Fixed panel with single door to '6' side opening in and out
- + Bi-fold door to '7' side opening in and out
- + L-shaped curtain rail supplied
- + Supplied with special corner blocks designed to be trimmed on site to accommodate any radius to cover slip resistant flooring
- + Latches are included with Option BW screens
- + Standard 1800mm wide x 1800mm drop shower curtains supplied

Dimensions, Size Options & Product Codes:

Dimensions (lengths):

Shower Tray Size Options:	1	2	3	4	5	6	7	8	
								750mm	900mm
1400 x 900mm	696mm	665mm	427mm	382mm	1880mm	1400mm	900mm	91011L/R	91012L/R
1500 x 820mm	764mm	693mm	387mm	342mm	1880mm	1500mm	820mm	91018L/R	91020L/R

Please note: Compensators are set at mid point giving 14.5mm in and out adjustment on both sides.

L/R in the product code denotes whether the screen is Left or Right handed.

Please note: If you require a different size screen, poles or curtain we can accommodate this. Please refer to Made-to-Measure Screens on page 154

Standard Wet Floor – Option EW

EW

Left-handed

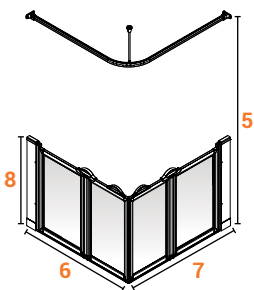
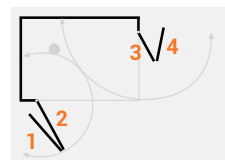

Right-handed

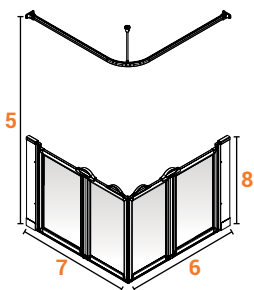
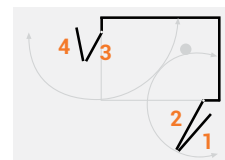

FEATURES

- + Handed/non-handed
- + Suitable for wet floors
- + Bi-fold doors to both '6' and '7' sides, opening in and out
- + L-shaped curtain rail supplied
- + Supplied with trimmable corner blocks designed to accommodate covered vinyl flooring
- + Handles are included
- + Standard 1800mm wide x 1800mm drop shower curtain supplied

Dimensions, Size Options & Product Codes:

Dimensions (lengths):

Shower Tray Size Options:	1	2	3	4	5	6	7	8	
								750mm	900mm
900 x 800mm	382mm	427mm	377mm	332mm	1880mm	900mm	800mm	91326L/R	–
900 x 900mm	382mm	427mm	427mm	382mm	1880mm	900mm	900mm	91171N	91170N
990 x 990mm	427mm	472mm	472mm	427mm	1880mm	990mm	990mm	91329N	–
1000 x 900mm	432mm	477mm	427mm	382mm	1880mm	1000mm	900mm	91328L/R	–
1000 x 1000mm	432mm	477mm	477mm	432mm	1880mm	1000mm	1000mm	91173N	91172N
1135 x 700mm	500mm	545mm	327mm	282mm	1880mm	1135mm	700mm	91325L/R	–
1135 x 770mm	500mm	545mm	362mm	317mm	1880mm	1135mm	770mm	91051L/R	91052L/R
1200 x 820mm	532mm	577mm	377mm	332mm	1880mm	1200mm	820mm	91327L/R	–
1200 x 900mm	577mm	532mm	427mm	382mm	1880mm	1200mm	900mm	91348L/R	–
1200 x 1000mm	532mm	577mm	477mm	432mm	1880mm	1200mm	1000mm	91324L/R	–
1200 x 1200mm	532mm	577mm	577mm	532mm	1880mm	1200mm	1200mm	91055N	91059N
1290 x 790mm	577mm	672mm	372mm	327mm	1880mm	1290mm	790mm	91346L/R	–
1300 x 820mm	582mm	627mm	387mm	342mm	1880mm	1300mm	820mm	91175L/R	91174L/R
1400 x 900mm	632mm	677mm	427mm	382mm	1880mm	1400mm	900mm	91065L/R	91066L/R
1485 x 800mm	720mm	675mm	377mm	332mm	1880mm	1485mm	800mm	91347L/R	–
1500 x 1200mm	727mm	682mm	577mm	532mm	1880mm	1500mm	1200mm	91349L/R	–
1500 x 820mm	682mm	727mm	387mm	342mm	1880mm	1500mm	820mm	91067L/R	91068L/R

Standard – Option EW5

EW5

Left-handed

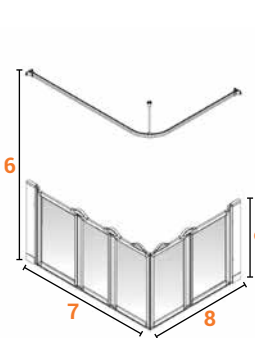
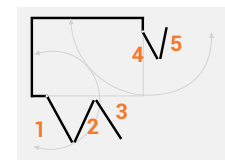

Right-handed

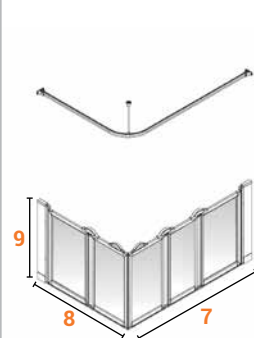
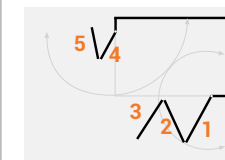

FEATURES

- + Handed
- + Smooth modern latches and D handles
- + 180° hinges enable doors to open both inwards and outwards
- + Bi-fold screens feature 360° hinges
- + Unique locking rising butt two-way hinges
- + Special corner blocks to be trimmed to accommodate any radius to covered slip resistant flooring
- + Handles are included with Option EW5 screens
- + Standard 1800mm wide x 1800mm drop shower curtains supplied
- + Supplied with an L-Shaped curtain rail

Dimensions, Size Options & Product Codes:

Dimensions (lengths):

Shower Tray Size Options:	1	2	3	4	5	6	7	8	9
									750mm
1200 x 820mm	390mm	373mm	345mm	387mm	342mm	1880mm	1200mm	820mm	91384L/R
1300 x 820mm	424mm	406mm	379mm	387mm	342mm	1880mm	1300mm	820mm	91385L/R
1400 x 900mm	457mm	439mm	412mm	427mm	382mm	1880mm	1400mm	900mm	91386L/R

L/R in the product code denotes whether the screen is Left or Right handed.

Please note: If you require a different size screen, poles or curtain we can accommodate this. Please refer to Made-to-Measure Screens on page 154

Standard Wet Floor – Option HW

HW

Left-handed

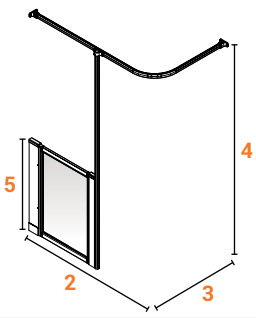
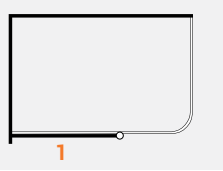

Right-handed

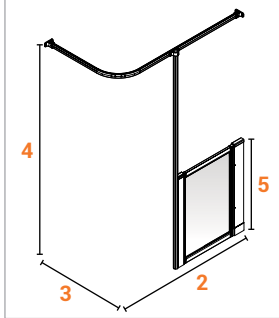
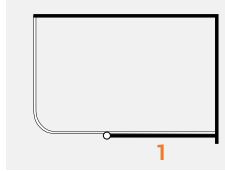

FEATURES

- + Handed
- + Suitable for wet floors
- + L-shaped curtain rail supplied
- + Supplied with special corner blocks designed to be trimmed on site, to accommodate any radius to covered slip resistant flooring
- + 1x 1400mm and 1x 1900mm drop curtains supplied

Dimensions, Size Options & Product Codes:

Dimensions (lengths):

Shower Tray Size Options:	1*	2	3	4	5	
					750mm	900mm
Will fit most tray sizes	300mm	Will fit most tray sizes	Will fit most tray sizes	1880mm	-	91330L/R
	400mm			1880mm	91331L/R	-
	600mm			1880mm	91232L/R	91233L/R
	700mm			1880mm	91234L/R	91235L/R
	800mm			1880mm	91236L/R	91237L/R
	900mm			1880mm	91238L/R	91239L/R
	1000mm			1880mm	91240L/R	91241L/R

*Column 1: Includes 32mm post.

L/R in the product code denotes whether the screen is Left or Right handed.

Standard Wet Floor – Option HFW

HFW

Non-handed

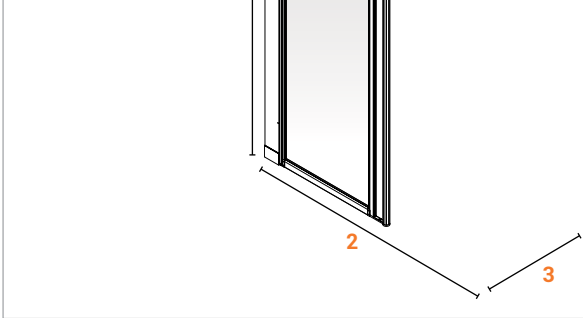
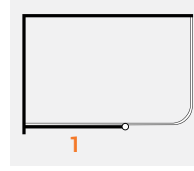

FEATURES

- + Non-handed
- + Suitable for wet floors
- + Full height
- + L-shaped curtain rail supplied
- + Supplied with special corner blocks designed to be trimmed on site, to accommodate any radius to covered slip resistant flooring
- + 1 x 1900mm drop curtain supplied

Dimensions, Size Options & Product Codes:

Dimensions (lengths):

Shower Tray Size Options:	1*	2	3	4	Code:
					600mm
700mm	1880mm	91248N			
800mm	1880mm	91249N			
900mm	1880mm	91250N			
1000mm	1880mm	91251N			

Please note: Compensators are set at mid point giving 14.5mm in and out adjustment on one side.

*Column 1: Includes 55mm gap and 32mm post.

Please note: If you require a different size screen, poles or curtain we can accommodate this. Please refer to Made-to-Measure Screens on page 154

Standard Wet Floor – Option MW MW

Non-handed

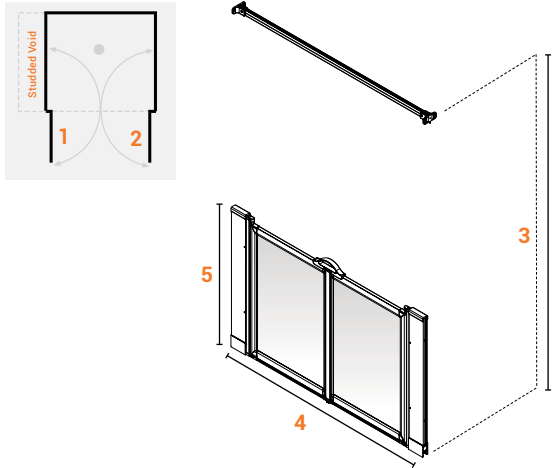

FEATURES

- + Non-handed
- + Suitable for wet floors
- + Bi-parting doors opening in and out
- + Supplied with straight curtain rail
- + Supplied with special corner blocks designed to be trimmed on site to accommodate any radius to covered slip resistant flooring
- + Latch included (additional handles are optional extras)
- + Standard 1800mm wide x 1800mm drop shower curtains supplied

Dimensions, Size Options & Product Codes:

Dimensions (lengths):

Shower Tray Size Options:	1	2	3	4	5	
					750mm	900mm
1100mm*	497mm	497mm	1880mm	1100mm	91350N	–
1200mm	547mm	547mm	1880mm	1200mm	91177N	91176N

* supplied with a L-shaped rail

Please note: Compensators are set at mid point giving 14.5mm in and out adjustment on both sides.

Standard Wet Floor – Option NW NW

Non-handed

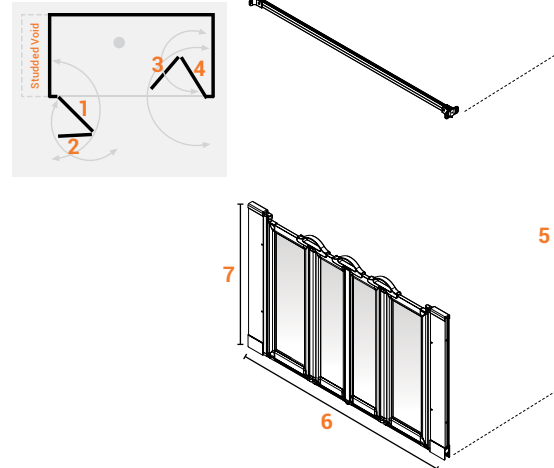

FEATURES

- + Non-handed
- + Suitable for wet floors
- + Bi-parting doors opening in and out
- + Trimmable L-shaped curtain rail supplied
- + Supplied with special corner blocks designed to be trimmed on site to accommodate any radius to covered slip resistant flooring
- + Standard 1800mm wide x 1800mm drop shower curtains supplied

Dimensions, Size Options & Product Codes:

Dimensions (lengths):

Shower Tray Size Options:	1	2	3	4	5	6	7	
							750mm	900mm
1150mm	279mm	244mm	244mm	279mm	1880mm	1150mm	91351N	–
1200mm	292mm	257mm	257mm	292mm	1880mm	1200mm	91352N	–
1250mm	304mm	269mm	269mm	304mm	1880mm	1250mm	91353N	–
1300mm	317mm	282mm	282mm	317mm	1880mm	1300mm	91179N	91178N
1350mm	329mm	294mm	294mm	329mm	1880mm	1350mm	91354N	–
1400mm	347mm	312mm	312mm	347mm	1880mm	1400mm	91112N	91120N
1450mm	354mm	319mm	319mm	354mm	1880mm	1450mm	91355N	–
1500mm	367mm	332mm	332mm	367mm	1880mm	1500mm	91181N	91180N
1550mm	379mm	344mm	344mm	379mm	1880mm	1550mm	91356N	–
1600mm	392mm	357mm	357mm	392mm	1880mm	1600mm	91323N	91123N
1650mm	404mm	369mm	369mm	404mm	1880mm	1650mm	91357N	–
1700mm	417mm	382mm	382mm	417mm	1880mm	1700mm	91332N	–
1750mm	429mm	394mm	394mm	429mm	1880mm	1750mm	91358N	–
1800mm	442mm	407mm	407mm	442mm	1800mm	1800mm	91333N	91334N

Standard Wet Floor – Option PW

PW

Left-handed

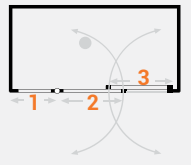

Right-handed

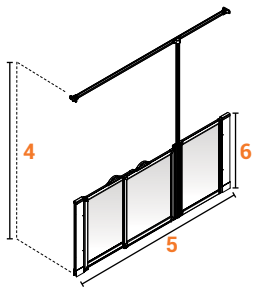
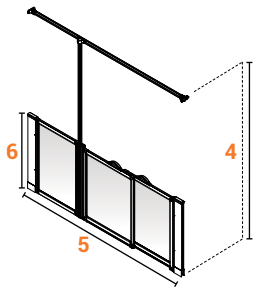
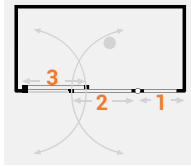

FEATURES

- + Handed
- + Suitable for wet floors
- + Fixed panel with bi-parting, overlapping doors, opening in and out
- + Straight curtain rail can be cut to fit
- + Supplied with special corner blocks designed to be trimmed on site to accommodate any radius to covered slip resistant flooring
- + Handles are included with Option PW screens
- + Standard 1800mm wide x 1800mm drop shower curtains supplied

Dimensions, Size Options & Product Codes:

Dimensions (lengths):

Shower Tray Size Options:	1	2	3	4	5*	6	
						750mm	900mm
1800mm	560mm	629mm	641mm	1880mm	1500-1800mm	91183L/R	91182L/R

Please note: Compensators are set at mid point giving 14.5mm in and out adjustment on both sides. Overlapping doors enable the Option P screen set to be adjusted on site to accommodate different alcove widths. This avoids the need for accurate pre-measurement and specially made screens.

*Column 5: measurements account for adjustment with overlapping doors.

L/R in the product code denotes whether the screen is Left or Right handed.

Standard Wet Floor – Option TTW

TTW

Left-handed

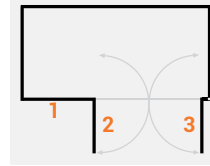

Right-handed

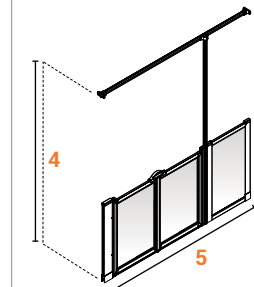
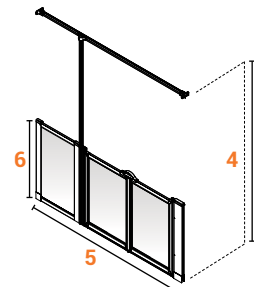
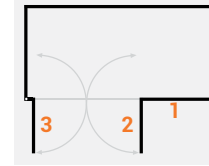

FEATURES

- + Handed
- + Suitable for wet floors
- + Trimmable panel with bi-parting doors, opening in and out
- + Straight curtain rail supplied
- + Latch included (additional handles are optional extras)
- + Standard 1800mm wide x 1800mm drop shower curtains supplied

Dimensions, Size Options & Product Codes:

Dimensions (lengths):

Shower Tray Size Options:	1*	2	3	4	5*	6	
						750mm	900mm
1500-1800mm	685mm	517mm	517mm	1880mm	1500-1800mm	91185L/R	91184L/R

Please note: Compensators are set at mid point giving 14.5mm in and out adjustment on door side only. Option TTW screens can be used with Pipe Ducted Formers on door side only.

*Column 1: Trimmable panel size range.

**Column 5: measurements account for adjustment (on door side only) with trimmable panel.

L/R in the product code denotes whether the screen is Left or Right handed.

Please note: If you require a different size screen, poles or curtain we can accommodate this. Please refer to Made-to-Measure Screens on page 154

Standard Wet Floor – Option UW

UW

Left-handed

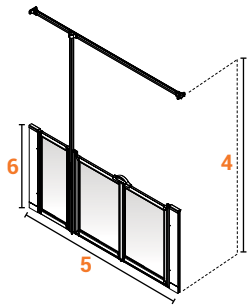
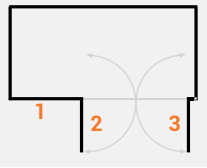

Right-handed

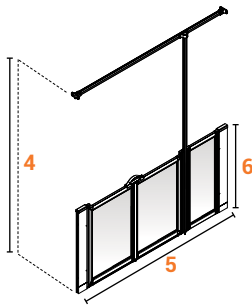
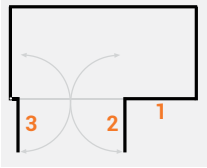

FEATURES

- + Handed
- + Suitable for wet floors
- + Fixed panel with bi-parting doors, opening in and out
- + L-shaped curtain rail supplied
- + Special corner blocks designed to be trimmed on site to accommodate any radius to covered slip resistant flooring
- + Latch is included on Option UW screens
- + Standard 1800mm wide x 1800mm drop shower curtains supplied

Dimensions, Size Options & Product Codes:

Dimensions (lengths):

Shower Tray Size Options:	1	2	3	4	5	6 750mm
1300mm	500mm	372mm	372mm	1880mm	1300mm	91359L/R
1350mm	500mm	397mm	397mm	1880mm	1350mm	91360L/R
1500mm	500mm	472mm	472mm	1880mm	1500mm	91361L/R
1550mm	500mm	497mm	497mm	1880mm	1550mm	91362L/R
1600mm	500mm	522mm	522mm	1880mm	1600mm	91363L/R
1650mm	500mm	547mm	547mm	1880mm	1650mm	91364L/R
1700mm	500mm	572mm	572mm	1880mm	1700mm	91365L/R
1750mm	500mm	597mm	597mm	1880mm	1750mm	91366L/R
1800mm	500mm	622mm	622mm	1880mm	1800mm	91367L/R

Please note: Compensators are set at mid point giving 14.5mm in and out adjustment on both sides.

L/R in the product code denotes whether the screen is Left or Right handed.

Standard Wet Floor – Option XW

XW

Left-handed

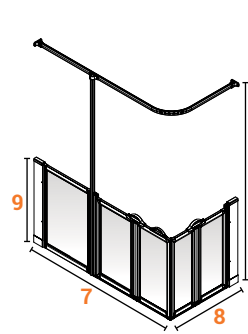
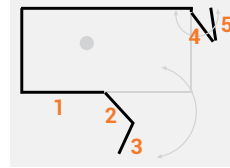

Right-handed

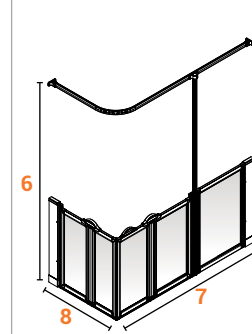
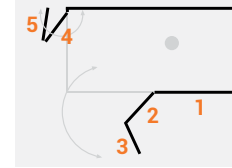

FEATURES

- + Handed
- + Suitable for wet floors
- + Fixed panel with bi-fold doors to '7' side opening in and out
- + Bi-fold door to '8' side opening in and out
- + L-shaped curtain rail supplied
- + Supplied with special corner blocks designed to be trimmed on site to accommodate any radius to covered slip resistant flooring
- + Handles and latch are included on Option XW screens
- + Standard 1800mm wide x 1800mm drop shower curtains supplied

Dimensions, Size Options & Product Codes:

Dimensions (lengths):

Shower Tray Size Options:	1	2	3	4	5	6	7	8	9	
									750mm	900mm
1300 x 820mm	522mm	391mm	346mm	387mm	342mm	1880mm	1300mm	820mm	91134L/R	91136L/R
1500 x 820mm	692mm	406mm	361mm	387mm	342mm	1880mm	1500mm	820mm	91142L/R	91144L/R

Please note: Compensators are set at mid point giving 14.5mm in and out adjustment on both sides.

L/R in the product code denotes whether the screen is Left or Right handed.

Please note: If you require a different size screen, poles or curtain we can accommodate this. Please refer to Made-to-Measure Screens on page 154

Standard Wet Floor – Option ZUW ZUW

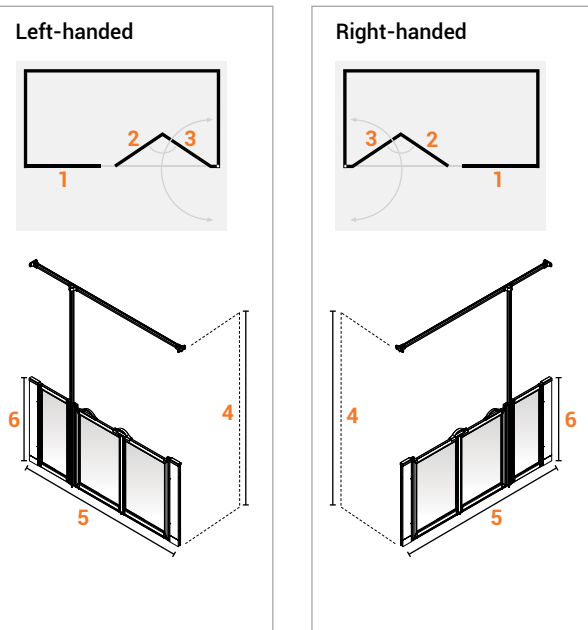

- FEATURES**
- + Handed
 - + Suitable for wet floors
 - + Fixed panel with Bi-folding doors, opening in and out
 - + L-shaped curtain rail supplied
 - + Special corner blocks designed to be trimmed on site to accommodate any radius to covered slip resistant flooring
 - + Handle and latch are included on Option ZUW screens
 - + Standard 1800mm wide x 1800mm drop shower curtains supplied

Dimensions, Size Options & Product Codes:

Dimensions (lengths):

Shower Tray Size Options:	1	2	3	4	5	6 750mm
1300mm	500mm	341mm	376mm	1880mm	1300mm	91368L/R
1350mm	500mm	366mm	401mm	1880mm	1350mm	91369L/R
1400mm	500mm	391mm	426mm	1880mm	1400mm	91370L/R
1450mm	500mm	416mm	451mm	1880mm	1450mm	91371L/R
1500mm	500mm	441mm	476mm	1880mm	1500mm	91372L/R
1550mm	500mm	466mm	501mm	1880mm	1550mm	91373L/R
1600mm	500mm	491mm	526mm	1880mm	1600mm	91374L/R
1650mm	500mm	516mm	551mm	1880mm	1650mm	91375L/R
1700mm	500mm	541mm	576mm	1880mm	1700mm	91376L/R
1750mm	500mm	566mm	601mm	1880mm	1750mm	91377L/R
1800mm	500mm	591mm	626mm	1880mm	1800mm	91378L/R

Please note: Compensators are set at mid point giving 14.5mm in and out adjustment on both sides.

L/R in the product code denotes whether the screen is Left or Right handed.

Standard Wet Floor – Option ZW ZW

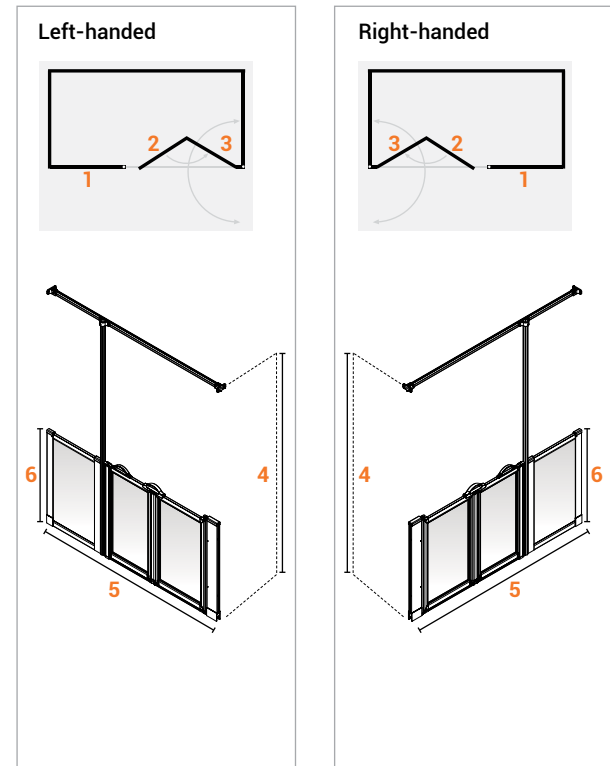

- FEATURES**
- + Handed
 - + Suitable for wet floors
 - + Bi-folding doors to give a 900mm clear entry path, opening in and out
 - + Fixed panel is trimmable on-site to suit alcove situations
 - + Straight curtain rail can be cut to fit
 - + Supplied with special corner blocks designed to be trimmed on site to accommodate any radius to covered slip resistant flooring
 - + Handle and latch are included on Option ZW screens
 - + Standard 1800mm wide x 1800mm drop shower curtains supplied

Dimensions, Size Options & Product Codes:

Dimensions (lengths):

Shower Tray Size Options:	1*	2	3	4	5**	6	
						750mm	900mm
1800mm	810mm	483mm	518mm	1880mm	1500-1800mm	91187L/R	91186L/R

Please note: Compensators are set at mid point giving 14.5mm in and out adjustment on door side only. Option ZW screens can be used with Pipe Ducted Formers on door side only.

*Column 1: Trimmable panel size range.
 **Column 5: measurements account for adjustment (on door side only) with trimmable panel.

L/R in the product code denotes whether the screen is Left or Right handed.

Please note: If you require a different size screen, poles or curtain we can accommodate this. Please refer to Made-to-Measure Screens on page 154

SILVERDALE® SHOWER SCREENS

All of our Silverdale® shower screens are designed specifically for the mobility and domestic market. These attractive silver screens will compliment any bathroom. Screens include 180 degree rising butt hinges and 360 degree bifold hinge. Silverdale screens are available in two finishes - Clear (SC) or Frosted glazing (F).



Silverdale® – Option A

A

Left-handed

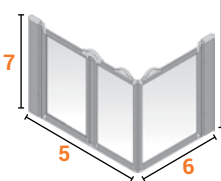
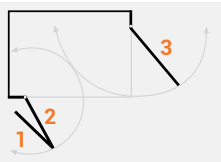

Right-handed

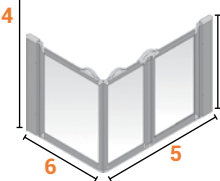
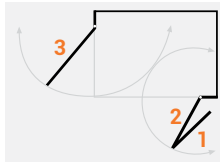

FEATURES

- + Handed
- + Suitable for shower trays
- + Bi-fold door to '5' side opening in and out
- + Single door to '6' side opening in and out
- + L-shaped curtain rail supplied
- + Latch and Handles are included with Option A screens
- + Drop rod is 600mm
- + Standard 1800mm wide x 1800mm drop shower curtains supplied

Dimensions, Size Options & Product Codes:

Dimensions (lengths):

Shower Tray Size Options:	1	2	3	4	5	6	7	
							750mm	900mm
1000 x 700mm	432mm	477mm	615mm	1880mm	1000mm	700mm	91001LSC/F* 91001RSC/F*	91002LSC/F* 91002RSC/F*
1200 x 700mm	532mm	577mm	615mm	1880mm	1200mm	700mm	91003LSC/F* 91003RSC/F*	91004LSC/F* 91004RSC/F*
1300 x 700mm	582mm	627mm	615mm	1880mm	1300mm	700mm	91005LSC/F* 91005RSC/F*	91006LSC/F* 91006RSC/F*

Please note: Compensators are set at mid point giving 14.5mm in and out adjustment on both sides.

Silverdale® screens are not suitable for trays fitted with pipe duct kits.

*C/F in the product code denotes whether the screen has a Clear or Frosted finish.

L/R in the product code denotes whether the screen is Left or Right handed.

Silverdale® – Option B

B

Left-handed

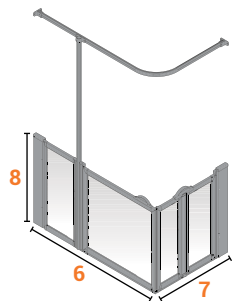
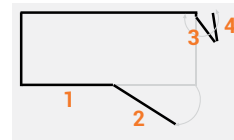

Right-handed

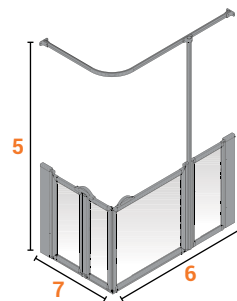
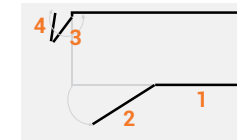

FEATURES

- + Handed
- + Suitable for shower trays
- + Side panel with single door to '6' side opening in and out
- + Bi-fold doors to '7' side opening in and out
- + L-shaped curtain rail supplied
- + Latch and handle are included with Option B screens
- + Available in frosted glazing
- + Standard 1800mm wide x 1800mm drop shower curtains supplied

Dimensions, Size Options & Product Codes:

Dimensions (lengths):

Shower Tray Size Options:	1	2	3	4	5	6	7	8
1420 x 700mm	692mm	685mm	327mm	282mm	1880mm	1420mm	700mm	900mm
								91015LSF/RSF

Please note: Compensators are set at mid point giving 14.5mm in and out adjustment on both sides. Silverdale® screens are not suitable for trays fitted with pipe duct kits.

L/R in the product code denotes whether the screen is Left or Right handed.

Silverdale® – Option E

E

Left-handed

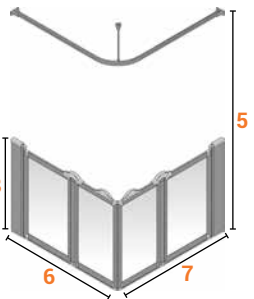
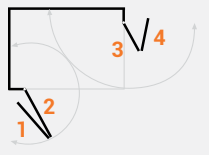

Right-handed

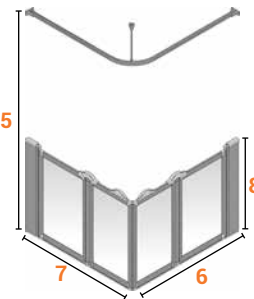
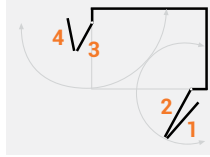

FEATURES

- + Handed
- + Suitable for shower trays
- + Bi-fold doors to '6' and '7' sides, opening in and out
- + L-shaped curtain rail supplied
- + Handles are included with Option E screens
- + Available in clear or frosted glazing
- + Standard 1800mm wide x 1800mm drop shower curtains supplied

Dimensions, Size Options & Product Codes:

Dimensions (lengths):

Shower Tray Size Options:	1	2	3	4	5	6	7	8	
								750mm	900mm
800 x 800mm	332mm	377mm	377mm	332mm	1880mm	800mm	800mm	91041NSC/F*	91042NSC/F*
820 x 820mm	342mm	387mm	387mm	342mm	1880mm	820mm	820mm	91043NSC/F*	91044NSC/F*
900 x 900mm	382mm	427mm	427mm	382mm	1880mm	900mm	900mm	91045NSC/F*	91046NSC/F*
1000 x 700mm	432mm	477mm	327mm	282mm	1880mm	1000mm	700mm	91047LSC/F*	91049LSC/F*
								91047RSC/F*	91049RSC/F*
1000 x 1000mm	432mm	477mm	477mm	432mm	1880mm	1000mm	1000mm	91048NSC/F*	91050NSC/F*
1200 x 700mm	532mm	577mm	327mm	282mm	1880mm	1200mm	700mm	91053LSC/F*	91057LSC/F*
								91053RSC/F*	91057RSC/F*
1200 x 820mm	532mm	577mm	387mm	342mm	1880mm	1200mm	820mm	91054LSC/F*	91058LSC/F*
								91054RSC/F*	91058RSC/F*
1200 x 900mm	532mm	577mm	427mm	382mm	1880mm	1200mm	900mm	91056LSC/F*	91060LSC/F*
								91056RSC/F*	91060RSC/F*
1300 x 700mm	582mm	627mm	327mm	282mm	1880mm	1300mm	700mm	91061LSC/F*	91063LSC/F*
								91061RSC/F*	91063RSC/F*
1300 x 820mm	582mm	627mm	387mm	342mm	1880mm	1300mm	820mm	91062LSC/F*	91064LSC/F*
								91062RSC/F*	91064RSC/F*

Please note: Compensators are set at mid point giving 14.5mm in and out adjustment on both sides. Silverdale® screens are not suitable for trays fitted with pipe duct kits.

*C/F in the product code denotes whether the screen has a Clear or Frosted finish.

Silverdale® – Option HF

HF

Non-handed

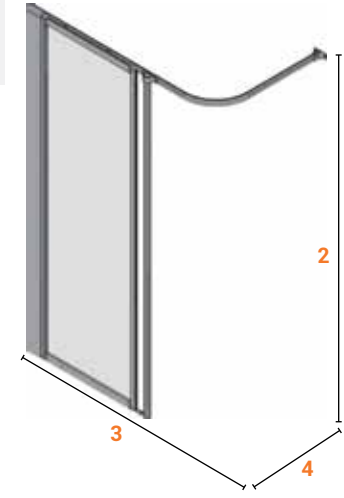
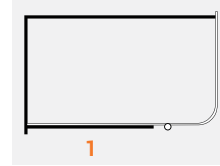

FEATURES

- + Non-handed
- + Suitable for shower trays
- + Full height
- + Fits all tray sizes LH and RH
- + L-shaped curtain rail supplied
- + Available in clear or frosted glazing
- + 1 x 1900mm drop curtain supplied

Dimensions, Size Options & Product Codes:

Dimensions (lengths):

Shower Tray Size Options:	1*	2	3	4	Code:
Will fit most tray sizes	600mm	1880mm	Will fit most tray sizes	Will fit most tray sizes	91079NSC/F**
	700mm	1880mm			91080NSC/F**
	800mm	1880mm			91081NSC/F**
	900mm	1880mm			91082NSC/F**
	1000mm	1880mm			91083NSC/F**

Please note: Compensators are set at mid point giving 14.5mm in and out adjustment on both sides. Screen width needs to be less than the length of the tray and provide adequate access for user.

Silverdale® screens are not suitable for trays fitted with pipe duct kits.

*Column 1: Includes 55mm grip gap and 32mm post

**C/F in the product code denotes whether the screen has a Clear or Frosted finish.

Silverdale® – Option M

M

Non-handed

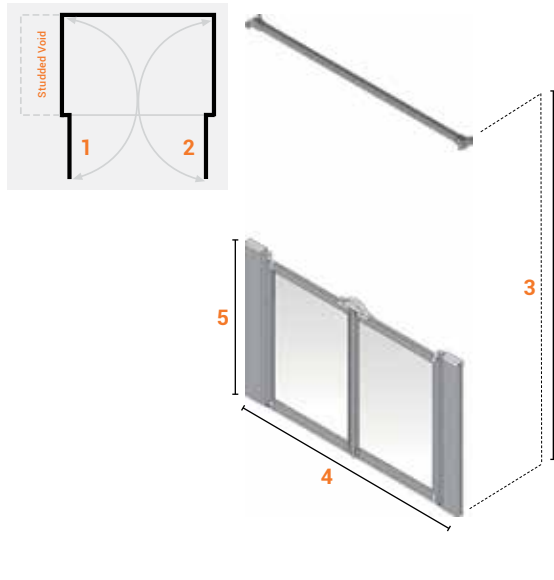

FEATURES

- + Non-handed
- + Suitable for shower trays
- + Bi-parting doors opening in and out
- + L-shaped curtain rail supplied
- + Available in clear or frosted glazing
- + Handle to Latch are included with Option M screens
- + Standard 1800mm wide x 1800mm drop shower curtains supplied

Dimensions, Size Options & Product Codes:

Dimensions (lengths):

Shower Tray Size Options:	1	2	3	4	5	
					750mm	900mm
800mm	347mm	347mm	1880mm	800mm	91104NSC/F*	91109NSC/F*
900mm	397mm	397mm	1880mm	900mm	91100NSC/F*	91105NSC/F*
1000mm	447mm	447mm	1880mm	1000mm	91101NSC/F*	91106NSC/F*
1200mm	547mm	547mm	1880mm	1200mm	91102NSC/F*	91107NSC/F*
1300mm	597mm	597mm	1880mm	1300mm	91103NSC/F*	91108NSC/F*

Please note: Compensators are set at mid point giving 14.5mm in and out adjustment on both sides.
Silverdale® screens are not suitable for trays fitted with pipe duct kits.

*C/F in the product code denotes whether the screen has a Clear or Frosted finish.

Silverdale® – Option N

N

Non-handed

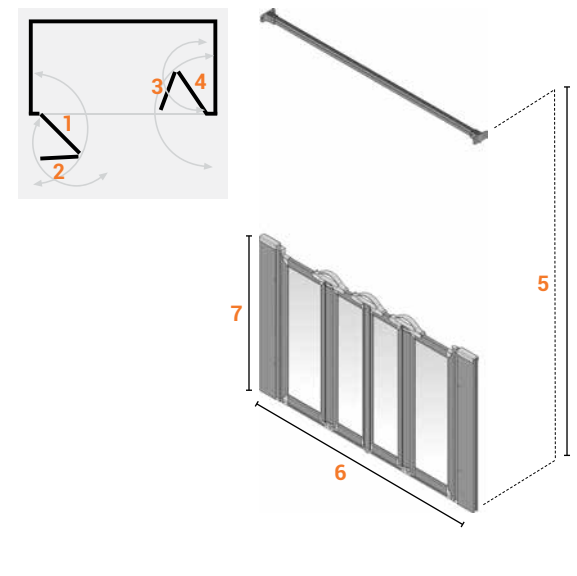

FEATURES

- + Non-handed
- + Suitable for shower trays
- + Double bi-folding doors, opening in and out
- + L-shaped curtain rail supplied
- + Available in clear or frosted glazing
- + Latches are included with Option N screens
- + Standard 1800mm wide x 1800mm drop shower curtains supplied

Dimensions, Size Options & Product Codes:

Dimensions (lengths):

Shower Tray Size Options:	1	2	3	4	5	6	7	
							750mm	900mm
1200mm	292mm	257mm	257mm	292mm	1880mm	1200mm	91110NSC/F*	91118NSC/F*
1300mm	317mm	282mm	282mm	317mm	1880mm	1300mm	91111NSC/F*	91119NSC/F*
1420mm	347mm	312mm	312mm	347mm	1880mm	1420mm	91113NSC/F*	91121NSC/F*
1500mm	367mm	332mm	332mm	367mm	1880mm	1500mm	91114NSC/F*	91122NSC/F*
1700mm**	417mm	382mm	382mm	417mm	1880mm	1700mm	91117NSC/F*	91124NSC/F*

Please note: Compensators are set at mid point giving 14.5mm in and out adjustment on both sides.
Silverdale® screens are not suitable for trays fitted with pipe duct kits.

*C/F in the product code denotes whether the screen has a Clear or Frosted finish.

**Straight curtain rail supplied.



Silverdale® – Option TT

TT

Left-handed

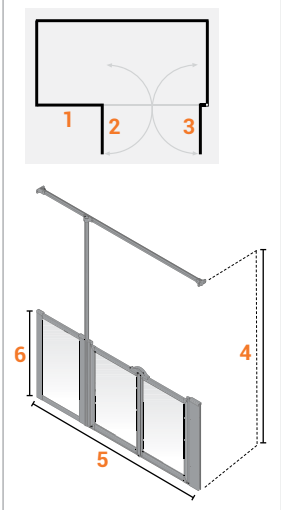

Right-handed

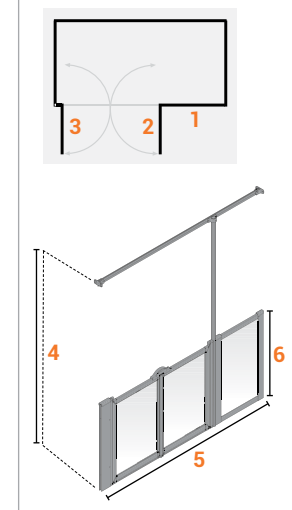

FEATURES

- + Handed
- + Suitable for shower trays
- + Trimmable panel with bi-parting doors, opening in and out
- + Straight curtain rail supplied
- + Latch are included with Option TT screens
- + Standard 1800mm wide x 1800mm drop shower curtains supplied

Dimensions, Size Options & Product Codes:

Dimensions (lengths):

Shower Tray Size Options:	1*	2	3	4	5**	6 900mm
1500-1800mm	385-685mm	517mm	517mm	1880mm	1500-1800mm	91128LSF/RSF

Please note: Compensators are set at mid point giving 14.5mm in and out adjustment on door side only. Option TT screen, handed, with bi-parting doors to give 900mm clear entry path, opening in and out. Fixed panel is trimmable on-site to suit alcove situations. All options Patented GB 2429030.

Silverdale® screens are not suitable for trays fitted with pipe duct kits.

*Column 1: Trimmable panel size range.

**Column 5: measurements account for adjustment (on door side only) with trimmable panel.

L/R in the product code denotes whether the screen is Left or Right handed.

Silverdale® – Option X

X

Left-handed

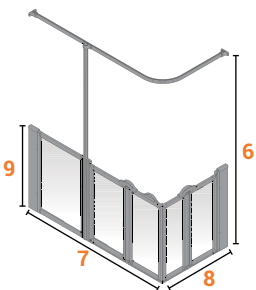
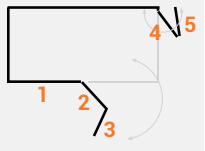

Right-handed

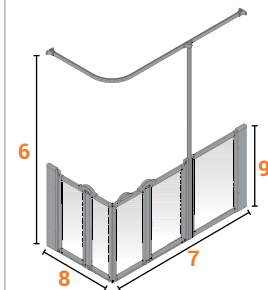
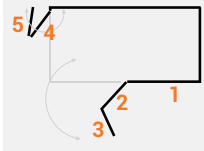

FEATURES

- + Handed
- + Suitable for shower trays
- + Fixed side panel on '7' and bi-folding doors on '7' and '8', opening in and out
- + L-shaped curtain rail supplied
- + Latches and handles are included with Option X screens
- + Standard 1800mm wide x 1800mm drop shower curtains supplied

Dimensions, Size Options & Product Codes:

Dimensions (lengths):

Shower Tray Size Options:	1	2	3	4	5	6	7	8	9 900mm
1420 x 700mm	692mm	366mm	321mm	327mm	282mm	1880mm	1420mm	700mm	91139LSF/RSF

Please note: Compensators are set at mid point giving 14.5mm in and out adjustment on both sides.
Silverdale® screens are not suitable for trays fitted with pipe duct kits.

L/R in the product code denotes whether the screen is Left or Right handed.

Silverdale® – Option XF

XF

Left-handed

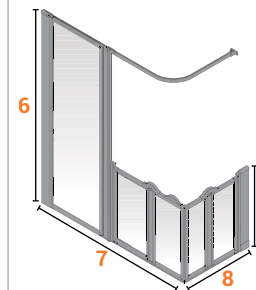
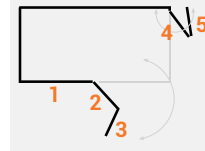

Right-handed

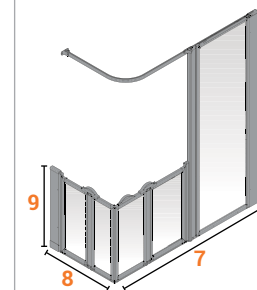
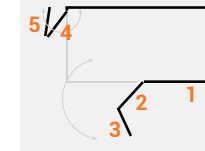

FEATURES

- + Handed
- + Suitable for shower trays
- + Full height
- + Fixed side panel on '7' and bi-folding doors on '7' and '8', opening in and out
- + L-shaped curtain rail supplied
- + Latches and handle are included with Option XF screens
- + Standard 1800mm wide x 1800mm drop shower curtains supplied

Dimensions, Size Options & Product Codes:

Dimensions (lengths):

Shower Tray Size Options:	1	2	3	4	5	6	7	8	9 900mm
1800 x 700mm	800mm	498mm	460mm	323mm	285mm	1880mm	1800mm	700mm	91339LSF/RSF
1800 x 820mm	800mm	498mm	460mm	383mm	345mm	1880mm	1800mm	820mm	91340LSF/RSF

Please note: Compensators are set at mid point giving 14.5mm in and out adjustment on both sides.
Silverdale® screens are not suitable for trays fitted with pipe duct kits.

L/R in the product code denotes whether the screen is Left or Right handed.

Silverdale® – Option Y

Y

Left-handed

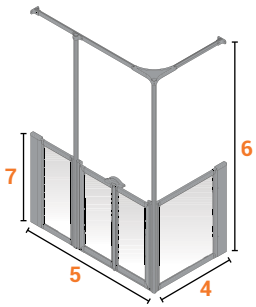
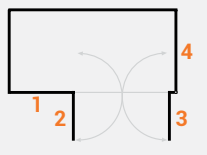

Right-handed

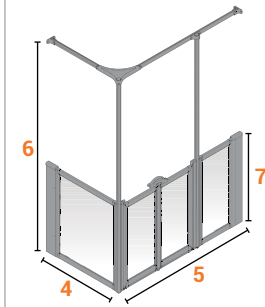
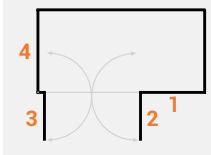

FEATURES

- + Handed
- + Suitable for shower trays
- + Fixed side panel and bi-parting doors to '5' side. Fixed side panel to '4' side
- + L-shaped curtain rail supplied
- + Latch is included with Option Y screens
- + Standard 1800mm wide x 1800mm drop shower curtains supplied

Dimensions, Size Options & Product Codes:

Dimensions (lengths):

Shower Tray Size Options:	1	2	3	4	5	6	7 900mm
1420 x 700mm	500mm	437mm	437mm	700mm	1420mm	1880mm	9115LSF/RSF
1700 x 700mm	702mm	477mm	477mm	700mm	1700mm	1880mm	9115LSF/RSF

Please note: Compensators are set at mid point giving 14.5mm in and out adjustment on both sides. Silverdale® screens are not suitable for trays fitted with pipe duct kits.

L/R in the product code denotes whether the screen is Left or Right handed.

SILVERDALE® WET FLOOR SHOWER SCREENS

All of our Silverdale® **wet floor** screens can be installed in a variety of configurations and have strong well designed seals for a continuous watertight barrier. Screens include 180 degree rising butt hinges and 360 degree bifold hinge. Silverdale screens are available in two finishes – Clear (SC) or Frosted glazing (F)



Silverdale® Wet Floor – Option EW

EW

Left-handed

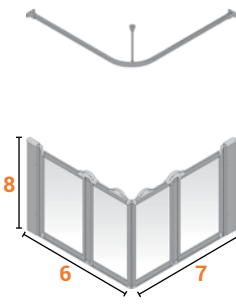
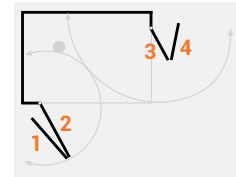

Right-handed

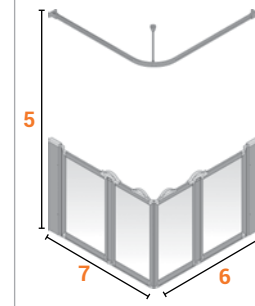
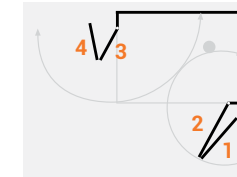

FEATURES

- + Handed
- + Suitable for wet floors
- + Bi-fold doors to both '6' and '7' sides, opening in and out
- + L-shaped curtain rail supplied
- + Supplied with trimmable corner blocks to accommodate covered slip resistant flooring
- + Handles are included with Option EW screens
- + Drop rod is 600mm
- + Standard 1800mm wide x 1800mm drop shower curtains supplied

Dimensions, Size Options & Product Codes:

Dimensions (lengths):

Shower Tray Size Options:	1	2	3	4	5	6	7	8	
								750mm	900mm
900 x 900mm	382mm	427mm	427mm	382mm	1880mm	900mm	900mm	9117INSC/F	9117ONSC/F
1000 x 1000mm	432mm	477mm	477mm	432mm	1880mm	1000mm	1000mm	91173NSC/F	91172NSC/F
1135 x 770mm	500mm	545mm	362mm	317mm	1880mm	1135mm	770mm	91051LSC/F	91052LSC/F
1200 x 1200mm	532mm	577mm	577mm	532mm	1880mm	1200mm	1200mm	91055NSC/F	91059NSC/F
1300 x 820mm	582mm	627mm	387mm	342mm	1880mm	1300mm	820mm	91175LSC/F	91174LSC/F
1400 x 900mm	632mm	677mm	427mm	382mm	1880mm	1400mm	900mm	91065LSC/F	91066LSC/F
1500 x 820mm	682mm	727mm	387mm	342mm	1880mm	1500mm	820mm	91067LSC/F	91068LSC/F
								91051RSC/F	91052RSC/F
								91055NSC/F	91059NSC/F
								91175RSC/F	91174RSC/F
								91065RSC/F	91066RSC/F
								91067RSC/F	91068RSC/F

Please note: Compensators are set at mid point giving 14.5mm in and out adjustment on both sides. Silverdale® screens are not suitable for trays fitted with pipe duct kits.

°C/F in the product code denotes whether the screen has a Clear or Frosted finish.

Silverdale® Wet Floor – Option HFW

HFW

Non-handed

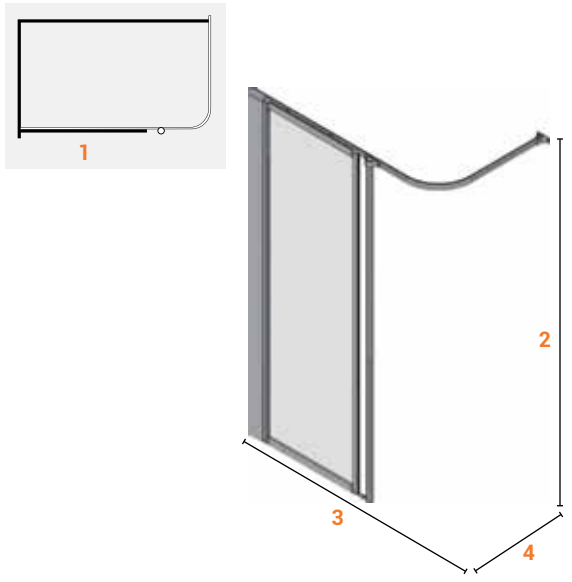

FEATURES

- + Non-handed
- + Suitable for wet floors
- + L-shaped curtain rail supplied
- + Supplied with special corner blocks designed to be trimmed on site to accommodate any radius to cover slip resistant flooring
- + Available in clear or frosted glazing***
- + 1x 1900mm drop curtain supplied

Dimensions, Size Options & Product Codes:

Dimensions (lengths):

Shower Tray Size Options:	1*	2	3	4	Code:
Will fit most tray sizes	400mm	1870mm	Will fit most tray sizes	Will fit most tray sizes	91345NSF**
	600mm	1870mm			91247NSC/F**
	700mm	1870mm			91248NSC/F**
	800mm	1870mm			91249NSC/F**
	900mm	1870mm			91250NSC/F**
	1000mm	1870mm			91251NSC/F**

Please note: Compensator is set at mid point giving 14.5mm in and out adjustment on both sides.
Silverdale® screens are not suitable for trays fitted with pipe duct kits.

*Column 1: Includes 55mm gap and 32mm post.

**C/F in the product code denotes whether the screen has a Clear or Frosted finish.

***400mm width screen currently only available in Frosted finish.

Silverdale® Wet Floor – Option MW

MW

Non-handed

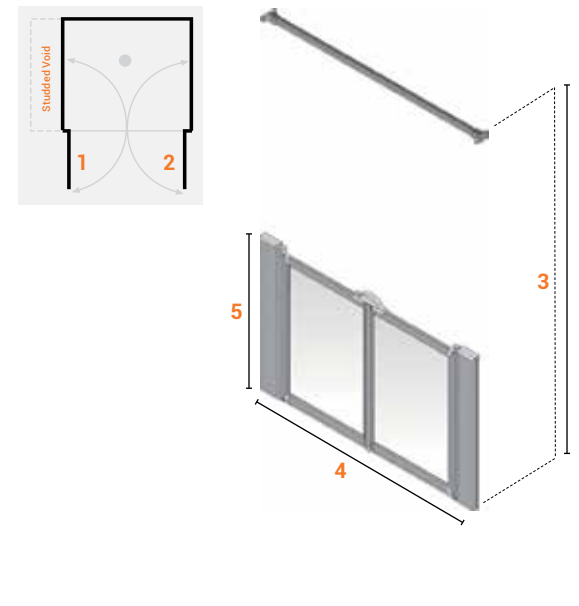

FEATURES

- + Non-handed
- + Suitable for wet floors
- + Bi-parting doors opening in and out
- + Supplied with straight curtain rail
- + Supplied with special corner blocks designed to be trimmed on site to accommodate any radius to cover slip resistant flooring
- + Latch is included on Option MW screens
- + Available in clear or frosted glazing
- + Standard 1800mm wide x 1800mm drop shower curtains supplied

Dimensions, Size Options & Product Codes:

Dimensions (lengths):

Shower Tray Size Options:	1	2	3	4	5	
					750mm	900mm
1200 x 1200mm	547mm	547mm	1880mm	1200mm	91177NSC/F*	91176NSC/F*

Please note: Compensators are set at mid point giving 14.5mm in and out adjustment on both sides.
Silverdale® screens are not suitable for trays fitted with pipe duct kits.

*C/F in the product code denotes whether the screen has a Clear or Frosted finish.

Silverdale® Wet Floor – Option NW

NW

Non-handed

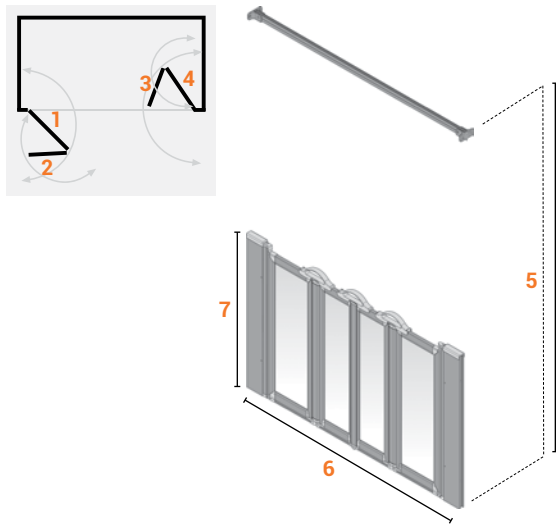

FEATURES

- + Non-handed
- + Suitable for wet floors
- + Bi-folding doors opening in and out
- + L-shaped curtain rail supplied
- + Supplied with special corner blocks designed to be trimmed on site to accommodate any radius to covered slip resistant flooring
- + Latches are included on Option NW screens
- + Available in clear or frosted glazing
- + Standard 1800mm wide x 1800mm drop shower curtains supplied

Dimensions, Size Options & Product Codes:

Dimensions (lengths):

Shower Tray Size Options:	1	2	3	4	5	6	7	
							750mm	900mm
1300mm	317mm	282mm	282mm	317mm	1880mm	1300mm	91179NSC/F*	91178NSC/F*
1400mm	347mm	312mm	312mm	347mm	1880mm	1400mm	91112NSC/F*	91120NSC/F*
1500mm	367mm	332mm	332mm	367mm	1880mm	1500mm	91181NSC/F*	91180NSC/F*
1600mm**	392mm	357mm	357mm	392mm	1880mm	1600mm	91323NSC/F*	91123NSC/F*

Please note: Compensators are set at mid point giving 14.5mm in and out adjustment on both sides.
Silverdale® screens are not suitable for trays fitted with pipe duct kits.

*C/F in the product code denotes whether the screen has a Clear or Frosted finish.

**Straight curtain rail supplied.

Model features a straight rail rather than curved

SLIDING SHOWER SCREENS

Our sliding screens can be installed with a variety of shower trays and wet floors and have designed seals to reduce water egress. Suitable for all trays and wet floors. Supplied with trimmable corner blocks to accommodate covered slip resistant flooring



Sliding – Option SE

SE

Left-handed

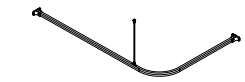
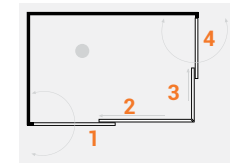

Right-handed

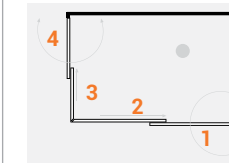

FEATURES

- + Handed and non-handed
- + Screens suitable for all trays and wet floors
- + L-shaped curtain rail can be cut to fit
- + Handles are included on Option SE screens
- + 2 x 1800mm wide by 1800mm long curtains supplied

Dimensions, Size Options & Product Codes:

Dimensions (lengths):

Shower Tray Size Options:	1	2	3	4	5	6	7	8
								750mm
900-1000mm x 900-1000mm	558mm	510mm	510mm	558mm	900 - 1000mm	900 - 1000mm	1880mm	15500
1200-1300mm x 700-820mm	708mm	660mm	420mm	468mm	1200 - 1300mm	700 - 820mm	1880mm	15501L/R
1420-1500mm x 700-820mm	808mm	760mm	420mm	468mm	1420 - 1500mm	700 - 820mm	1880mm	15502L/R

Please note: Sliding screen compensators give 14.5mm adjustment inwards and outwards on both sides.

L/R in the product code denotes whether the screen is Left or Right handed.

Please note: If you require a different size screen, poles or curtain we can accommodate this. Please refer to Made-to-Measure Screens on page 154

Sliding – Option SJ

SJ

Left-handed

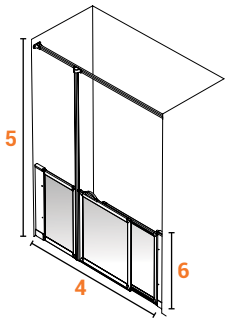
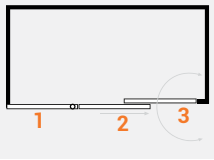

Right-handed

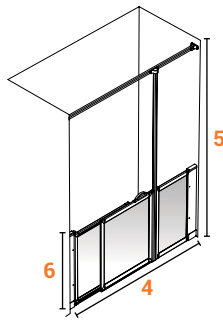
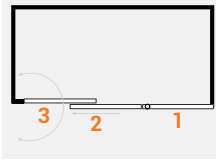

FEATURES

- + Handed
- + Suitable for all trays and wet floors
- + L-shaped curtain rail supplied
- + Handles are included on Option SJ screens
- + 2 x 1800mm wide by 1800mm long curtains supplied

Dimensions, Size Options & Product Codes:

Dimensions (lengths):

Shower Tray Size Options:	1	2	3	4	5	6 750mm
1200-1300mm	450mm	430mm	475mm	1200-1300mm	1880mm	15506L/R
1420-1500mm	600mm	455mm	500mm	1420-1500mm	1880mm	15507L/R
1700-1800mm*	600mm	622mm	572mm	1700-1800mm	1880mm	15522L/R

Please note: Sliding screen compensators give 14.5mm adjustment inwards and outwards.

*Straight curtain rail supplied.

 Model features a straight rail rather than curved

L/R in the product code denotes whether the screen is Left or Right handed.

Sliding – Option SM

SM

Left-handed

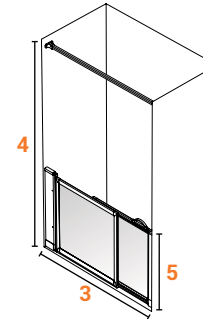
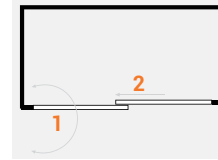

Right-handed

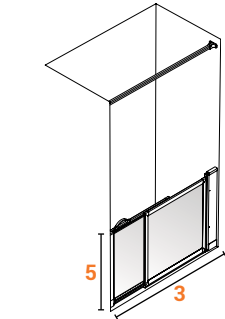
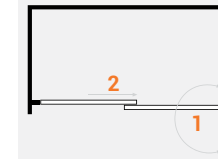

FEATURES

- + Handed
- + Suitable for all trays and wet floors
- + L-shaped curtain rail supplied
- + Handles are included on Option SM screens
- + 2 x 1800mm wide by 1800mm long curtains supplied

Dimensions, Size Options & Product Codes:

Dimensions (lengths):

Shower Tray Size Options:	1	2	3	4	5 750mm
900-1000mm	538mm	493mm	900-1000mm	1880mm	15503L/R
1200-1300mm	688mm	643mm	1200-1300mm	1880mm	15504L/R
1420-1500mm	788mm	743mm	1420-1500mm	1880mm	15505L/R

Please note: Sliding screen compensators give 14.5mm adjustment inwards and outwards on one side only.

L/R in the product code denotes whether the screen is Left or Right handed.

Please note: If you require a different size screen, poles or curtain we can accommodate this. Please refer to Made-to-Measure Screens on page 154

Sliding – Option SN SN

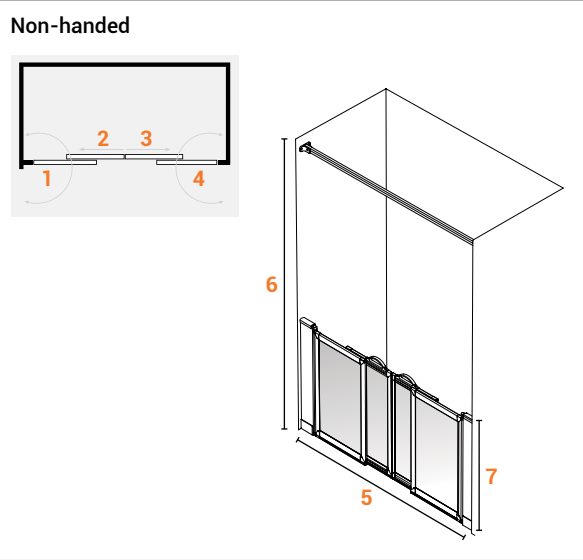

Non-handed

FEATURES

- + Non-handed
- + Suitable for all trays and wet floors
- + L-shaped curtain rail supplied
- + Handles are included on Option SN screens
- + 2 x 1800mm wide by 1800mm long curtains supplied

Dimensions, Size Options & Product Codes:

Dimensions (lengths):

Shower Tray Size Options:	1	2	3	4	5	6	7 750mm
1200-1300mm	402mm	325mm	325mm	402mm	1200-1300mm	1880mm	15508
1420-1500mm	452mm	402mm	402mm	452mm	1420-1500 mm	1880mm	15509
1700-1800mm*	527mm	477mm	477mm	527mm	1700-1800mm	1880mm	15510

Please note: Sliding screen compensators give 14.5mm adjustment inwards and outwards.
*Straight curtain rail supplied.

Sliding – Option SU SU

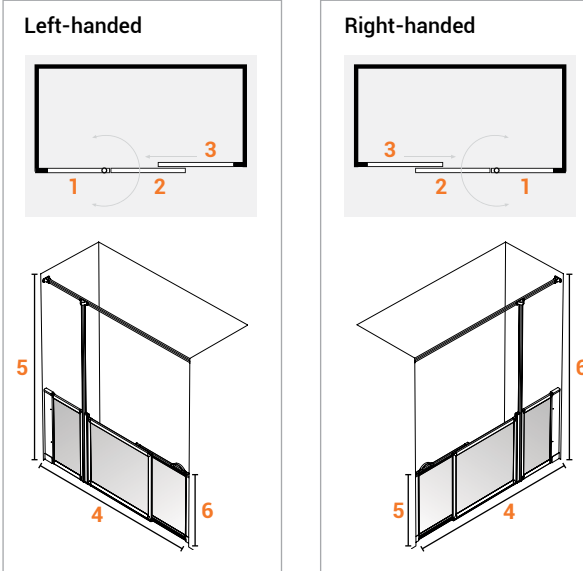

Left-handed

Right-handed

FEATURES

- + Handed
- + Suitable for all trays and wet floors
- + L-shaped curtain rail supplied
- + Handles are included on Option SU screens
- + 2 x 1800mm wide by 1800mm long curtains supplied

Dimensions, Size Options & Product Codes:

Dimensions (lengths):

Shower Tray Size Options:	1	2	3	4	5	6 750mm
1135-1300mm	450mm	500mm	455mm	1135-1300mm	1880mm	15511L/R
1420-1500mm	600mm	525mm	480mm	1420-1500mm	1880mm	15512L/R
1700-1800mm*	800mm	575mm	528mm	1700-1800mm	1880mm	15513L/R

Please note: Compensators are set at mid point giving 14.5mm in and out adjustment on door hinge side only.
*Straight curtain rail supplied.

L/R in the product code denotes whether the screen is Left or Right handed.

Please note: If you require a different size screen, poles or curtain we can accommodate this. Please refer to Made-to-Measure Screens on page 154

Sliding – Option SX SX

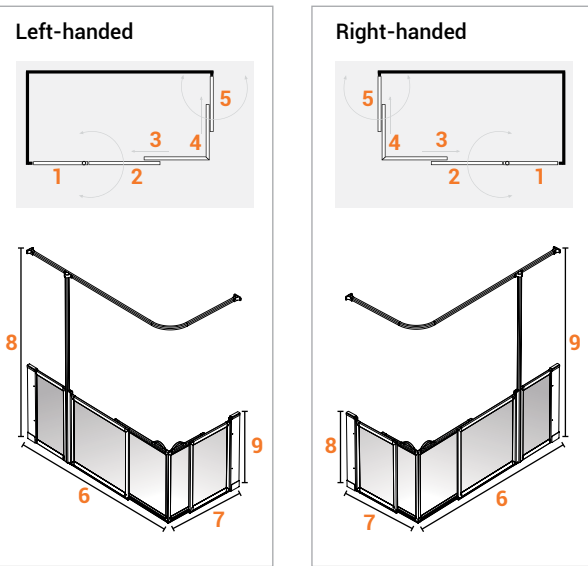

- FEATURES**
- + Handed
 - + Suitable for all trays and wet floors
 - + L-shaped curtain rail can be cut to fit
 - + Supplied with special corner blocks designed to be trimmed on site to accommodate any radius to covered slip resistant flooring
 - + Handles are included on Option SX screens

Dimensions, Size Options & Product Codes:

Dimensions (lengths):

Shower Tray Size Options:	1	2	3	4	5	6	7	8	9 750mm
1200-1300mm	450mm	513mm	465mm	420mm	468mm	1200-1300mm	700-820mm	1880mm	15514L/R
1420-1500mm	600mm	538mm	490mm	420mm	468mm	1420-1500mm	700-820mm	1880mm	15515L/R
1700-1800mm	800mm	581mm	543mm	420mm	468mm	1700-1800mm	700-820mm	1880mm	15516L/R

Please note: Sliding screen compensators give 14.5mm adjustment inwards and outwards.

L/R in the product code denotes whether the screen is Left or Right handed.

Sliding – Option SY SY

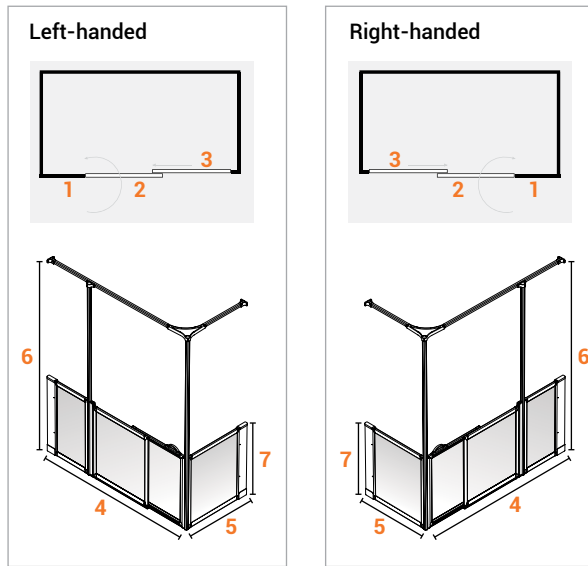

- FEATURES**
- + Handed
 - + Suitable for all trays and wet floors
 - + L-shaped curtain rail can be cut to fit
 - + Supplied with special corner blocks designed to be trimmed on site to accommodate any radius to covered slip resistant flooring
 - + Handles are included on Option SY screens

Dimensions, Size Options & Product Codes:

Dimensions (lengths):

Shower Tray Size Options:	1	2	3	4	5	6	7 750mm
1200-1300mm x 700mm	450mm	500mm	455mm	1200-1300mm	700mm	1880mm	15517L/R
1200-1300mm x 820mm	450mm	500mm	455mm	1200-1300mm	820mm	1880mm	15518L/R
1420-1500mm x 700mm	600mm	525mm	481mm	1420-1500mm	700mm	1880mm	15519L/R
1420-1500mm x 820mm	600mm	525mm	481mm	1420-1500mm	820mm	1880mm	15520L/R

Please note: Sliding screen compensators give 14.5mm adjustment inwards and outwards.

L/R in the product code denotes whether the screen is Left or Right handed.

Please note: If you require a different size screen, poles or curtain we can accommodate this. Please refer to Made-to-Measure Screens on page 154

MADE-TO-MEASURE SHOWER SCREENS

In addition to standard screens, AKW offer a made-to-measure screen service and can manufacture almost any screen combination to your requirements. Below are illustrations of some of the more typical requirements.

Curtain rails and standard 1800mm wide x 1800mm drop shower curtains are supplied with made-to-measure screens.



i Specifying Made-to-Measure Shower Screens

When specifying for AKW trays, please state:

- + Tray type
- + Tray size
- + Tray handing (if any)
- + Accurate drawing (giving measurements for panel and post sizes or door entry width)

When specifying for wet floor areas, consider:

- + Rise and fall hinges to clear the floor
- + Corner blocks. Trim on site to fit the corner radius on safety flooring
- + Accurate drawing required

When specifying for wall-to-wall screens, we need:

- + Wall-to-wall measurements at floor height and at the screen height (750mm, 900mm or 1880mm), after completion of wall tiling

⚙ Ordering Made-to-Measure Shower Screens

☎ 01905 823 299

📄 01905 823 297

@ orders@akw-ltd.co.uk

Made to measure screens now available with next day delivery to accommodate your basket (with agreed specification and material availability).

AKW can make special screens to fit asafety floors or any of our trays. Alternatively if you require a different screen configuration and can provide us with an accurate drawing, we will be able to quote for individual requirements.

Note: Made-to-Measure screens are non-returnable and non-refundable.

Made-to-Measure – Option MM1/MM1F

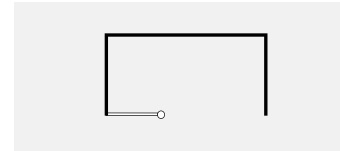
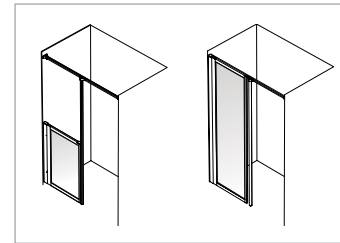

FEATURES

- + 1 fixed panel
- + Various sizes and configurations available
- + Half (MM1) and full height (MM1F) options available

Product Codes:

Half Height M-to-M Screen MM1	91160
Full Height M-to-M Screen MM1F	91161
Half Height M-to-M Silverdale Screen MM1	91160S
Full Height M-to-M Silverdale Screen MM1F	91161S

Made-to-Measure – Option MM2/MM2F

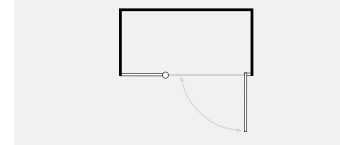
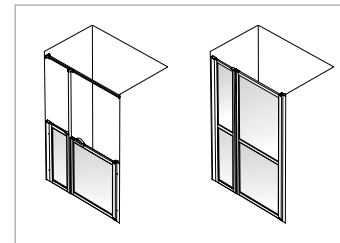

FEATURES

- + 1 fixed panel and 1 door opening out only
- + Various sizes and configurations available
- + Half (MM2) and full height (MM2F) options available

Product Codes:

Half Height M-to-M Screen MM2	91162
Full Height M-to-M Screen MM2F	91163
Half Height M-to-M Silverdale Screen MM2	91162S
Full Height M-to-M Silverdale Screen MM2F	91163S

Made-to-Measure – Option MM3/MM3F

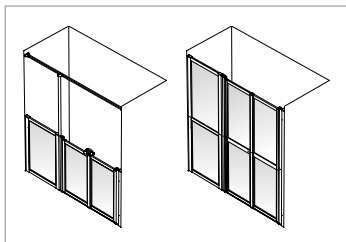
**FEATURES**

- + 1 fixed panel and 2 bi-parting doors
- + Various sizes and configurations available
- + Half (MM3) and full height (MM3F) options available

Product Codes:

Half Height M-to-M Screen MM3 **91164**

Full Height M-to-M Screen MM3F **91165**

Half Height M-to-M Silverdale Screen MM3 **91164S**

Full Height M-to-M Silverdale Screen MM3F **91165S**

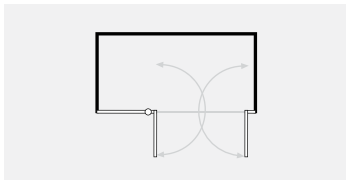

Made-to-Measure – Option MM4

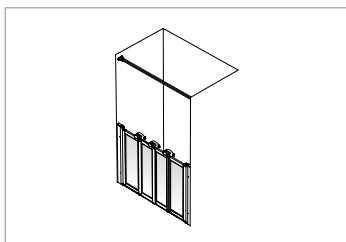
**FEATURES**

- + Twin bi-folding doors, opening in and out
- + Various sizes and configurations available
- + Bi-fold only available at half height
- + Minimum width: 1160mm

Product Code:

Half Height M-to-M Screen MM4 **91166**

Half Height M-to-M Silverdale Screen MM4 **91166S**

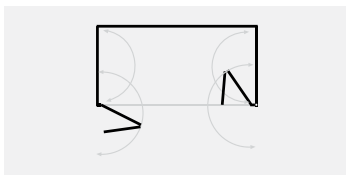

Made-to-Measure – Option MM5

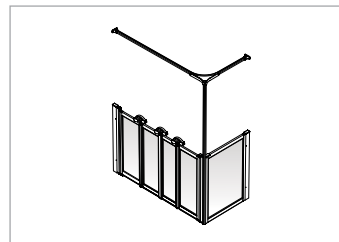
**FEATURES**

- + One fixed panel and twin bi-folding doors, opening in and out
- + Various sizes and configurations available
- + Bi-fold only available at half height
- + Minimum width: 1160mm

Product Code:

Half Height M-to-M Screen MM5 **91167**

Half Height M-to-M Silverdale Screen MM5 **91167S**

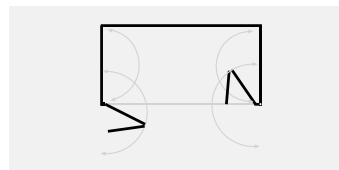



STANDALONE SHOWER CUBICLES

A standalone cubicle provides a comfortable showering solution that can be quickly installed in any room or bedroom, making it an ideal solution when an existing bathroom cannot be accessed and a quick adaptation is required.

Standalone Shower Cubicle



BENEFITS

- + Quick to install causing minimum disruption – meaning that a room can be converted quickly
- + Easy to fit thanks to the new slot together profile system
- + Can easily be moved giving flexibility if circumstances change
- + Option E screen provides an open sided option and provides best possible access
- + Optional grab rail and or riser rail can be fitted to assist with access and use
- + Self-contained cubicle meaning no alterations to the walls
- + Suitable for when floors cannot be breached
- + Can be fitted into any room up or downstairs
- + Optional ramp providing easy access when used with a surface mounted shower tray option

FEATURES

- + Uses Braddan or Sulby shower trays from current AKW product range providing both level access and surface mounted solutions
- + Gravity and pumped waste options
- + New, quick fit installation kit
- + Popular AKW carer screen options E and M
- + PET glazed screens and ceiling panel
- + Transparent ceiling panel for improved lighting
- + Polypropylene back and side panels
- + All cubicles include tray, screen, waste, curtain rail, curtain, gliders and fixings
- + Compatible with AKW showers, seats & grab rails

Standalone Shower Cubicle – Option E

Left-handed

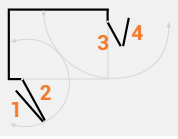

Right-handed

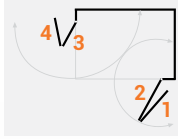

FEATURES

- + Handed
- + Bi-folding doors
- + Available with Sulby or Braddan shower trays
- + Latches and handle are included on Option E cubicles
- + Ramps and grab rails are available as optional extras
- + 2 x 1800mm wide by 1800mm long curtains supplied

Dimensions, Size Options & Product Codes:

Dimensions (lengths):

Shower Tray Size Options:	1	2	3	4	5	6	7	8	Codes (L/R):
1200 x 700mm (Sulby)	532mm	577mm	327mm	282mm	2100mm	1200mm	700mm	750mm	23731SL-UK 23731SR-UK
1200 x 820mm (Sulby)	532mm	577mm	387mm	342mm	2100mm	1200mm	820mm	750mm	23735SL-UK 23735SR-UK
1200 x 700mm (Braddan Gravity)	532mm	577mm	327mm	282mm	2050mm	1200mm	700mm	750mm	23731BGL-UK 23731BGR-UK
1200 x 820mm (Braddan Gravity)	532mm	577mm	387mm	342mm	2050mm	1200mm	820mm	750mm	23735BGL-UK 23735BGR-UK
1200 x 700mm (Braddan Uplift)	532mm	577mm	327mm	282mm	2050mm	1200mm	700mm	750mm	23731BPL-UK 23731BPR-UK
1200 x 820mm (Braddan Uplift)	532mm	577mm	387mm	342mm	2050mm	1200mm	820mm	750mm	23735BPL-UK 23735BPR-UK

Please note: Other sizes are available on request for Option E – please call customer services on 01905 823 299.

L/R in the product code denotes whether the screen is Left or Right handed.

Standalone Shower Cubicle – Option M

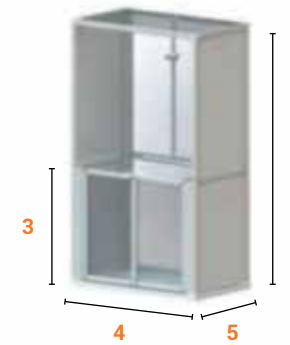
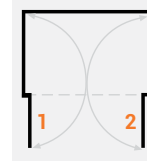

FEATURES

- + Non-handed
- + Bi-folding doors
- + Available with Sulby or Braddan shower trays
- + Latch is included on Option M cubicles
- + Ramps and grab rails are available as optional extras
- + 2 x 1800mm wide by 1800mm long curtains supplied

Dimensions, Size Options & Product Codes:

Dimensions (lengths):

Shower Tray Size Options:	1	2	3	4	5	6	Code:
1200 x 700mm (Sulby)	547mm	547mm	750mm	1200mm	700mm	2100mm	23711S-UK
1200 x 820mm (Sulby)	547mm	547mm	750mm	1200mm	820mm	2100mm	23717S-UK
1200 x 700mm (Braddan Gravity)	547mm	547mm	750mm	1200mm	700mm	2050mm	23711BG-UK
1200 x 820mm (Braddan Gravity)	547mm	547mm	750mm	1200mm	820mm	2050mm	23717BG-UK
1200 x 700mm (Braddan Uplift)	547mm	547mm	750mm	1200mm	700mm	2050mm	23711BP-UK
1200 x 820mm (Braddan Uplift)	547mm	547mm	750mm	1200mm	820mm	2050mm	23717BP-UK

Please note: Other sizes are available on request for Option M – please call customer services on 01905 823 299.

Standalone & Showerloo Optional Extras

Description	Dimensions	Product Code:
Straight ramp for Sulby Trays	700mm (w) x 480mm (d) x 90mm (h)	25009
40mm Straight Ramp for use with Braddan Trays (1800mm long)	1800mm (w) x 40mm (h)	25002
T Shape SS epoxy coated grab rail – White	1110mm x 300mm x 300mm	01246WH

SHOWERLOO SHOWER CUBICLES

AKW's Showerloo can be located anywhere in the home to provide a cost effective permanent or temporary solution.

Showerloo Shower Cubicle

Non-handed

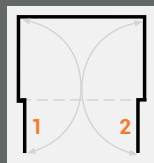

Dimensions, Size Options & Product Codes:

Dimensions (lengths):

Shower Tray Size Options:	1	2	3	4	5	6	Code:
1200 x 700mm	547mm	547mm	1200mm	700mm	750mm	1200mm	23800 BG-UK
1200 x 820mm	547mm	547mm	1200mm	820mm	750mm	1200mm	23801 BG-UK

Wall Hung Livenza WC Pack:

23105L

FEATURES

- + Non-handed
- + Self-contained cubicle
- + Available with Braddan shower trays
- + Handles are included on Showerloo cubicles
- + Ramps and grab rails are available as optional extras
- + All Showerloo cubicles include tray, screen, waste, glazed ceiling, curtain, rail, gliders and fixings
- + PET glazed screen and ceiling panel
- + Gravity and pumped waste options available
- + Polypropylene back and side panels
- + Showerloo cubicles have access panel as standard
- + Minimum width required for access panel is 15inch / 435mm

Shower Screen Accessories

FREEWAY PORTABLE SHOWER SCREENS

At 750mm and 900mm high, Freeway screens are ideal for use as a splash protector for a carer and can be used on designated trays or wet floors.

Freeway Portable Shower Screens

Portable 2 Panels



Portable 3 Panels



Portable 4 Panels



FEATURES

- + Portable
- + Suitable for shower trays and wet floors
- + D handles fitted as standard for ease of lifting and placement
- + Weight is between 10-13kg
- + 2, 3 and 4 panelled versions available

Dimensions, Size Options & Product Codes:

Dimensions (lengths):

Shower Screen Size Options:	1	2	3	4	5	6	Product Code	
							750mm	900mm
2 Panels: 650 x 650mm	650mm	650mm	-	-	-	-	15166	15342
2 Panels: 750 x 750mm	750mm	750mm	-	-	-	-	15165	15343
2 Panels: 1000 x 1000mm	1000mm	1000mm	-	-	-	-	15137	15344
3 Panels: 350 x 700mm	-	-	350mm	700mm	-	-	15136	15301
4 Panels: 400 x 225mm	-	-	-	-	400mm	225mm	15135	15345

SHOWER CURTAIN RAILS

Straight Curtain Rails*



Product Codes:

1900mm Straight Curtain Rail	24018
2135mm Straight Curtain Rail	24049
Made-to-Measure Straight Curtain Rail (up to 3180mm)	27202S
2530mm Silverdale® Straight Curtain Rail	24067S

Bendy Curtain Rails*



Product Codes:

2000mm Bendy Curtain Rail	24033
2000mm Bendy Curtain Rail & 2 Drop Rods	24033DR
2500mm Bendy Curtain Rail	24034
2500mm Bendy Curtain Rail & 2 Drop Rods	24034DR
3000mm Bendy Curtain Rail	24044
3000mm Bendy Curtain Rail & 2 Drop Rods	24044DR

L-Shaped Curtain Rails*



Product Codes:

1000 x 1000mm L-Shaped Curtain Rail	24043
1500 x 1200mm L-Shaped Curtain Rail	24126
1800 x 820mm L-Shaped Curtain Rail	24039
1800 x 820mm L-Shaped Curtain Rail (to fit Silverdale® Screen)	24039-S
2000 x 1000mm L-Shaped Curtain Rail	24048
Made-to-Measure L-Shaped Curtain Rail (up to 2530mm)	27202LS
Made-to-Measure L-Shaped Curtain Rail (2530-3180mm)	27202LM
Made-to-Measure L-Shaped Curtain Rail (3180-3550mm)	27202LL

U-Shaped Curtain Rails*

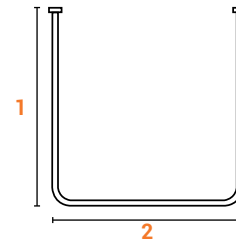

FEATURES

- + U-shaped curtain rail
- + Can be made-to-measure (3600mm max) – specify your chosen tray and screen combination when ordering
- + Can be cut-to-length to suit install
- + Includes 2 upright support posts (necessary for structural stability)
- + All curtain rails include 2 packs of hooks and gliders. Shower curtains are not included and should be ordered separately.

Dimensions, Size Options & Product Codes:

Dimensions (lengths):

Shower Tray Size Options:	1	2	Code:
900 x 900mm	900mm	820mm	24219
1000 x 700mm	700mm	920mm	24002
1000 x 1000mm	1000mm	920mm	24217
1050 x 1050mm	1050mm	970mm	24010
1135 x 770mm	770mm	1050mm	24220
1200 x 820mm	820mm	1120mm	24045
1200 x 1200mm	1200mm	1200mm	24009
1250 x 750mm	750mm	1170mm	24017
1300 x 700mm	700mm	1220mm	24027
1300 x 820mm	820mm	1220mm	24095
1350 x 750mm	750mm	1270mm	24218
1420 x 820mm	820mm	1340mm	24091
1470 x 750mm	750mm	1390mm	24014
1500 x 820mm	820mm	1420mm	24047
1700 x 700mm	700mm	1620mm	24046
1800 x 820mm	820mm	1720mm	24026
1850 x 750mm	750mm	1770mm	24021

Made-to-Measure U-Shaped Curtain Rail (up to 2530mm)	27202US
Made-to-Measure U-Shaped Curtain Rail (2530-3180mm)	27202UM
Made-to-Measure U-Shaped Curtain Rail (3180-3550mm)	27202UL
Made-to-Measure Silverdale U-shaped curtain rail (up to 2530mm)	27202-US-2

SHOWER CURTAIN RAIL ACCESSORIES

Drop Rods



Product Codes:

Standard Drop Rod (600mm)	drop.rod
Extra Long Drop Rod (2000mm)	BELI31
Single Curtain Rail Support Kit	ACRS1.Kit
Double Curtain Rail Support Kit	ACRS2.Kit

Window Spanning Kit



FEATURES

- + Robust, easy-to-fit and trimmable
- + Kit includes special wall bracket, hooks and gliders and a single curtain (1400mm long)

Product Codes:

Window Spanning Kit (Standard)	24210
Window Spanning Kit (Silverdale®)	24210S
Additional Wall-Fixing Brackets (Standard)	24213
Additional Wall-Fixing Brackets (Silverdale®)	24213S

32mm Diameter Upright Pole Extension Kit



FEATURES

- + Designed to give additional strength and rigidity to any screen options with a post
- + 950mm length (can be cut to length as required)

Product Codes:

Upright Pole Extension Kit (Standard)	24212
Upright Pole Extension Kit (Silverdale®)	24212S

32mm Diameter Back Support Pole



FEATURES

- + Suitable for vertical poles where upright support posts may need additional support
- + 950mm length (can be cut to suit tray width)

Product Codes:

Back Support Pole (Standard)	24211
Back Support Pole (Silverdale®)	24211S

Extra Wide Compensator



FEATURES

- + Designed to give approximately 50mm additional width to a standard shower screen enclosure area. Also for use with a pipe duct kit or where pipes have been boxed in.
- + 105mm width

Product Codes:

Size	Wet Floor	Standard
750mm (Non-Handed)	24139	24130
750mm (Left)*	24140	24131
750mm (Right)*	24141	24132
900mm (Non-Handed)	24142	24133
900mm (Left)*	24143	24134
900mm (Right)*	24144	24135
1870mm (Non-Handed)	24145	24136
1870mm (Left)*	24146	24137
1870mm (Right)*	24147	24138

*For use with Pipe Duct Kits.

Curtain Rail Connector



Product Code:

100mm Curtain Rail Connector	24036
------------------------------	--------------

SHOWER CURTAINS

Standard Shower Curtain



FEATURES

- + 1800 x 1800mm curtains are supplied as standard with all enclosures
- + Curtain material: 100% woven polyester
- + Sizes shown below are width x drop
- + All individual curtains include 2 packs of hooks and gliders.

Product Codes:

900 x 2000mm Shower Curtain	24074
1800 x 1400mm Shower Curtain	24075
1800 x 1800mm Shower Curtain	24076
1800 x 1900mm Shower Curtain	24077
1800 x 2000mm Shower Curtain	24078
1800 x 2100mm Shower Curtain	24079
1800 x 2400mm Shower Curtain	24080
2135 x 2135mm Shower Curtain	24073
Additional Hooks & Gliders (12 Pack)	24092
Curtain Rings (12 Pack)	24081

Heavy Duty Shower Curtain



Heavy duty shower curtains have the added benefit of being weighted to prevent the curtain billowing.

FEATURES

- + Curtain material: 100% woven polyester
- + Sizes shown below are width x drop

Product Codes:

1800 x 2000mm Heavy Duty Shower Curtain	24082
2400 x 2000mm Heavy Duty Shower Curtain	24083
2400 x 1800mm Heavy Duty Shower Curtain	24084
1800 x 1800mm Heavy Duty Shower Curtain	24085

SHOWER SCREEN HANDLES

D-Handles



FEATURES

- + Supplied as standard on most corner bi-parting doors but can be supplied on other doors if required
- + Also available in Blue (RAL5005) for the partially sighted and in Grey for Silverdale® screens

Product Codes:

White D-Handle (Grey capped screens)	24105WH
Blue D-Handle (Grey capped screens)	24105BU
Grey D-Handle (Silverdale® screens)	24105S

Door Latches



FEATURES

- + Supplied as standard on all bi-fold and bi-parting doors but can be supplied on other doors if required
- + Also available in Blue (RAL5005) for the partially sighted and in Grey for Silverdale® screens

Product Codes:

White D-Latch (Grey capped screens)	24106WH
Blue D-Latch (Grey capped screens)	24106BU
Grey D-Latch (Silverdale® screens)	24106S

Shower Wastes & Pumps

AKW's extensive range of wastes complement our range of wetroom formers and shower trays. The range includes gravity, dry and pumped wastes to cover all installations.

You may also need:

Showers	Showers
180 >	78 >

Showers	Showers
48 >	



GRAVITY WASTES

Standard Gravity Waste with 19mm or 50mm Water Trap



GW50 Patent: GB2418355

AKW Standard gravity waste with 19mm or 50mm water trap for Braddan trays or the Tuff Form® former with adaptor (see page 21).

FEATURES

- + Built in filter
- + 19mm or 50mm water trap depth (seal)
- + 50mm diameter threaded waste fitting
- + Depth below tray: 93mm (19mm) & 124mm (50mm)
- + Overall depth: 113mm (19mm) & 144mm (50mm)

Product Codes:

Standard Gravity Waste (19mm Water Trap) 25125

Standard Gravity Waste (50mm Water Trap) 25126

GW90 90mm Diameter Gravity Waste with 50mm Water Trap



GW90 Patent: GB2418355

Can be specified with any Mullen® or Low Profile tray. Alternatively can be fitted to the Tuff Form® former with adaptor.

FEATURES

- + Built in filter
- + Opens for easy cleaning and rodding
- + 50mm water trap depth (seal)
- + 90mm diameter threaded waste fitting
- + Depth below tray: 90mm
- + Overall depth: 110mm

Product Code:

GW90 Gravity Waste (50mm Water Trap) 25120

Low Depth GW90 90mm Diameter Gravity Waste with 50mm Water Trap



The low depth gravity waste has been designed for ease of installation and flexibility of fitting. The 90mm diameter waste with a 50mm water trap is suitable for Sulby 2, Low Profile and Mullen® trays where height restrictions are an issue. Alternatively it can be used with the Tuff Form® former with adaptor (see page 21).

FEATURES

- + Unique swivel outlet for quick and easy installation
- + 50mm water trap depth (seal)
- + Top access for easy cleaning and rodding
- + Built in filter
- + Depth below tray: 60mm
- + Overall depth: 82mm

Product Code:

**Low Depth GW90 Gravity Waste
(50mm Water Trap)** **25404**

GW90-2 Low Depth Wet Waste with TF Tiled Floor Adaptor



FEATURES

- + Shallow 53mm depth. Useful for solid floor or shallow joists.
- + Very compact
- + Good seals and location
- + 50mm water trap preventing bad odour backflow
- + Suitable for push fit pipe (with included adaptor)
- + Suitable for solvent weld pipe (w/included adaptor)
- + Top access for easy cleaning and rodding
- + High flow rate (27 l/min +15mm head + 1m pipe)

**GW90-2 Low Depth Wet Waste
with TF Tiled Floor Adaptor** **25498-UK**

GW90-2 Low Depth Wet Waste with Vinyl Floor Adaptor



FEATURES

- + Shallow 53mm depth. Useful for solid floors or shallow joists.
- + Very compact
- + Good seals and location
- + Suitable for push fit pipe (with included adaptor)
- + Suitable for solvent weld pipe (with included adaptor)
- + Top access for easy cleaning and rodding
- + High flow rate (27 l/min with 15mm head and 1m of pipe)
- + Meets the performance requirements of British standards

**GW90-2 Low Depth Wet Waste
with Vinyl Floor Adaptor** **25499-UK**



DRY WASTES

DW90 Low Depth Dry Shower Waste



Spare Parts:

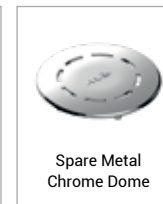

Low Depth Dry Shower Wastes suitable for Sulby 2, Low Profile and Mullen®. Also suitable for Tuff Form® former with adaptor (see page 21).

FEATURES

- + 90mm diameter: Suitable for trays with Ø 90mm waste hole
- + Very compact
- + Shallow 48mm depth. Useful for solid floors or shallow joists.
- + Non return valve preventing bad odour backflow
- + Trap will not dry out with sporadic use
- + Universal pipe fitment
- + Suitable for push fit pipe (with included adaptor)
- + Suitable for solvent weld pipe (with included adaptor)
- + Top access for easy cleaning
- + High flow rate (27 l/min with 15mm head and 1m of pipe)
- + Spare parts available: Plastic Chrome Dome, Metal Chrome Dome, Pipe Adaptor Kit and Dry Waste Non Return Valve

Product Codes:

DW90 Low Depth Dry Shower Waste	25492-UK
Spare Plastic Chrome Dome	16-006-008
Spare Metal Chrome Dome	16-006-038
Spare Pipe Adaptor Kit	16-006-058
Spare Dry Waste Non Return Valve	16-006-037

PUMPED WASTES

Standard PW50 50mm Diameter Pumped Waste with 15mm or 22mm Outlet



Exploded View

PW50 Patent: GB2375479

Issued as standard with both automatic and automatic mixer valve pump kits.

FEATURES

- + Built in filter
- + Top access for easy cleaning and rodding
- + 15 or 22mm John Guest Speedfit outlets available
- + Depth below tray: 38mm (15mm) & 44mm (22mm)
- + Overall depth: 50mm (15mm) & 56mm (22mm)

Product Codes:

Standard PW50 50mm Pumped Waste (15mm John Guest Speedfit Outlet)	25122
Standard PW50 50mm Pumped Waste (22mm John Guest Speedfit Outlet)	25405

PW90 90mm Diameter Pumped Waste with 15mm or 22mm Outlet



Exploded View

PW50 Patent: GB2375479

Specially designed shallow pump gulley (for Sulby 2 or Mullen®) with two baffle features that help to reduce the noise during showering cycles.

FEATURES

- + Built in filter
- + Top access for easy cleaning and rodding
- + 15 or 22mm John Guest Speedfit outlets available
- + Depth below tray: 36mm (15mm) & 44mm (22mm)
- + Overall depth: 58mm (15mm) & 66mm (22mm)

Product Codes:

PW90 90mm Pumped Waste (15mm John Guest Speedfit Outlet)	25105
PW90 90mm Pumped Waste (22mm John Guest Speedfit Outlet)	25406

DIGITAL WASTE PUMPS

AKW DigiPump Waste Pumps



All AKW DigiPump shower waste pumps can connect wirelessly to the AKW SmartCare Plus® Electric Shower.

See page 181.



Designed and manufactured by AKW, our comprehensive range of digital shower waste pumps suit installations where gravity drainage is not achievable.

BENEFITS

- + Quiet in operation, no disturbing noises
- + Compact: pump and controller enclosed in one unit
- + Easy to install

FEATURES

- + Models available to suit both electric and low pressure mixer showers
- + M11 option (for electric showers only), M17 option (for both electric and mixer showers), M20 option (ultimate performance for both electric and mixer showers)
- + Max flow rate: 11 litres/min (M11), 17 litres/min (M17) and 20 litres/min (M20) in 'real life' scenario testing
- + M11: 15mm inlet & 22mm outlet connectors
- + M17 & M20: 22mm inlet & outlet connectors
- + Non-handed (to fit left of right inlet)
- + Pump head uses 4 valves for better debris cleaning
- + Pump head can be rotated to allow flow in either direction
- + Internal TGA fuse
- + Activated by flow sensor
- + IP45 rated

AKW DigiPump Waste Pumps (Technical Information)



Product Specification:

Maximum Outlet Head	1.0m (39in)
Maximum Inlet Head	0.5m (19in)
Maximum Combined Head & Lift	1.5m (59in)
Supply	230V AC 50Hz 73W
Duty Cycle	30 mins max on 50% duty



Extended options available

BS EN 61558-1, BS EN 61558-2-6
 BS EN 60335-1, BS EN 60335-2-41
 BS EN 60529
 E MC Directive 89/336/EEC
 Low Voltage Directive 73/23/EEC

i Additional Flow Sensor Kit are required for use with dual feed showers
Product code: 25194

Product Codes:

Waste Installation:	M11 DigiPump Product Code:	M17 DigiPump Product Code:	M20 DigiPump Product Code:
Upward Discharge Waste	25471	-	-
Standard PW50 50mm Diameter Pumped Waste	25472	25452	25482
PW90 90mm Diameter Pumped Waste	25473	25453	25483
PGTF Tuff Form® Pumped Waste	25474	-	-
Screedmaster Waste	25475	-	-
SilentFlow+® Waste	25476	25458	25486
Link Pack with Upward Discharge Waste	25551	25461	-
Link Pack with Standard PW50 50mm Diameter Pumped Waste	25552	25462	25562
Link Pack with PW90 90mm Diameter Pumped Waste	25553	25463	25563
Link Pack with PGTF Tuff Form® Pumped Waste	25554	25464	25564
Link Pack with Screedmaster Waste	25555	25465	25565
Link Pack SilentFlow+® Waste	25556	25466	25566

AKW DigiPump SmartCare Plus® Wireless Waste Pump Kit



The AKW SmartCare Plus® shower works seamlessly with AKW DigiPump and Wireless Pump Interface Box to match the rate of flow.

FEATURES

- + IP45 rating so it is safe to be fitted within the showering area
- + Replaces flow meter on pump connection
- + Supplied with matched shower PCB and pump interface box
- + Can be fitted inside the pump case or on the wall
- + Requires no separate power supply (taken from pump signal wires)
- + Compatible with all AKW digital M pumps: M11, M17, M20
- + No wires and no mess means super-quick and easy installation in situations where gravity waste isn't suitable

Product Codes:

AKW SmartCare Plus® White	Smooth Hose			Spiral Hose		
	8.5kW	9.5kW	10.5kW	8.5kW	9.5kW	10.5kW
M11 DigiPump & SilentFlow+R Waste	29028WH	29027WH	29026WH	29065WH	29064WH	29063WH
M11 DigiPump & Standard PW50 Waste	29034WH	29033WH	29032WH	29053WH	29052WH	29051WH
M11 DigiPump & PW90 90mm Waste	29037WH	29036WH	29035WH	29056WH	29055WH	29054WH
M11 DigiPump & Screedmaster Waste	29040WH	29039WH	29038WH	29059WH	29058WH	29057WH
M11 DigiPump Only*	29043WH	29042WH	29041WH	29062WH	29061WH	29060WH

*for Upward Discharge Waste

Showers

Showering is an important part of life – that's why we've chosen a range of care showers to offer safe and comfortable showering, whatever the space or need.

You may also need:

Wastes & Pumps 170 >	Shower Screens 78 >
Shower Seats 226 >	Shower Trays 48 >
Plumbing Fittings 307 >	



ELECTRIC SHOWERS

AKW SmartCarePlus

AKW SmartCare Plus® Electric Shower



AKW SmartCare Plus® can connect wirelessly to all AKW DigiPump shower waste pumps.

See from page 177.



Contemporary styling combined with advanced technology to create the world's first Bluetooth® Smart enabled electric shower.

CARE FEATURES

- + Easy push-button controls: Power, Temperature, Flow
- + All controls closely grouped together
- + Raised tactile symbols: +, -, Temp, Flow
- + Audible Temperature and Flow Indicators
- + LED Illuminated Temperature and Flow Indicators
- + Matt anti-glare finish
- + Rounded surfaces and edges for safety
- + BEAB CARE Certified
- + RNIB Tried and Tested
- + Care kit: 2m hose, 150kg load-bearing rail 1m rail, easy-adjust shower head
- + Thermostatic Control and Phased/Auto Shutdown
- + Bluetooth® Smart wireless remote control (optional)
- + AKW SmartCare Plus® app for iOS and Android
- + Patented safety features

INSTALLER FEATURES

- + Super-quick and easy installation
- + 8 electrical/8 water entry points
- + Dual power blocks for left or right hand wiring
- + Retro-fit footprint covers most manufacturers' models
 - No re-tiling required
 - Existing cable & pipework compatible
- + 3-year warranty, extended options available
- + 8.5kW / 9.5kW / 10.5kW options
- + Comprehensive technical after-sales support
- + Wired or wireless connectivity to all AKW DigiPump shower waste pumps

Patent no. GB2560278

AKW SmartCare Plus® Electric Shower (Technical Information)

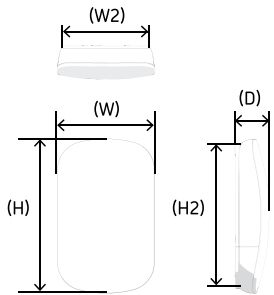

Physical Dimensions:

Height (H)	380mm
Width (W)	230mm
Depth (D)	85mm
Footprint Height (H2)	345mm
Footprint Width (W2)	210mm



Plumbing Supply:

Supply Source	Mains pressure cold water only
Minimum Dynamic Pressure	50kPa (0.5 Bar)
Maximum Static Pressure	1000 kPa (10 Bar)
Optimal Minimum Dynamic Pressure <i>(Recommended to ensure high performance)</i>	100 kPa (1 Bar)
Maximum Inlet Temperature	28°C
Minimum Inlet Temperature	2°C
Inlet Connection	15mm pipe
Outlet Connection	1/2" BSP Male Thread Fitting
Water Ingress Rating	IPX4
Shower Drain Pump Connections	Suitable for AKW M Series (Internal flow sensor or wireless)

Electricity Supply:

Nominal Rating at	240 V 10.5kW, 9.5kW & 8.5kW
Supply Fuse / Circuit Breaker	(10.5kW 45/50A), (9.5kW 40/45A) & (8.5kW 35/40A)
Residual Current Device (RCD)	30 mA (must be fitted)
Supply Cable	Refer to current wiring regulations and BS 7671 to determine minimum cable size. No larger than 10 mm ²
Isolation Switch (e.g. Pull Cord)	45 Amp Double pole
Water and Cable Entry Points	Top, bottom or back

Product Codes:

AKW SmartCare Plus White 10.5kw with silver/white kit	29010WH	AKW SmartCare Plus White 9.5kw with silver/white kit & spiral hose	29045WH
AKW SmartCare Plus White 9.5kw with silver/white kit	29011WH	AKW SmartCare Plus White 8.5kw with silver/white kit & spiral hose	29046WH
AKW SmartCare Plus White 8.5kw with silver/white kit	29012WH	AKW SmartCare Plus Spiral Hose Chrome	14-012-061
AKW SmartCare Plus White 10.5kw with silver/white kit & spiral hose	29044WH	Pump Wireless Module	29014
		Extended Warranty	25333

AKW SmartCare Plus® Electric Shower: Optional Extras

Smart Device App



Available on iOS & Android devices (search 'AKW Shower')

Use your iPhone or Android device to switch on AKW SmartCare Plus® from outside the shower area so you don't get wet, or from your bed so that it's ready for you. AKW SmartCare Plus® shower can turn on when your alarm goes off and send a 'shower ready' alert to your phone. Monitor shower usage and store preferred settings with multiple user profiles.

FEATURES

- + Full control via app
- + Create individual user profiles
- + Monitor usage: frequency, water, energy
- + Shower-ready alerts
- + Wake-up alarm & shower-on indicator
- + Works up to 10m away from shower unit

Wireless Remote



The Bluetooth® Smart wireless remote control provides flexibility and control, from up to 10 metres away. Tactile raised symbols, push-button control of Power, Temperature and Flow. A fully waterproof high grip casing means that it's easy to hold and use. Wall mount or attach to any flat surface with provided suction cups.

FEATURES

- + Raised symbols
- + Push-button controls
- + Fully waterproof
- + Works up to 10m away from shower unit
- + Control: Power, Temperature & Flow
- + Blue LED activity indicator
- + Wall mount included
- + Glass mount suction cups included

Product Code:

Wireless AKW SmartCare Plus® Remote **29013**

iTherm Electric Shower



The LED display, Power push-button and independent Temperature and Flow controls ensure the perfect thermostatically stabilised shower every time.

CARE FEATURES

- + Contemporary styling and high gloss finish
- + Easy push Power button, maintains Temp/Flow settings
- + LED Temperature Indicator
- + LED Flow Indicator
- + Independent Temperature and Flow controls
- + Thermostatically Stabilised Temperature
- + Phased/Auto Shutdown
- + Chrome accessories: adjustable riser rail (600mm length), 1.5m hose, multi-mode handset, soap dish
- + 8.5kW and 9.5kW options
- + Rounded surfaces and edges for safety
- + Patented safety features

INSTALLER FEATURES

- + Super-quick and easy installation
- + 8 electrical/8 water entry points
- + Dual power blocks for left or right hand wiring
- + Retro-fit footprint covers most manufacturers' models
 - No re-tiling required
 - Existing cable & pipework compatible
- + 3-year warranty
- + 8.5kW / 9.5kW options
- + Comprehensive technical after-sales support



Patent no. GB2560278

iTherm Electric Shower (Technical Information)

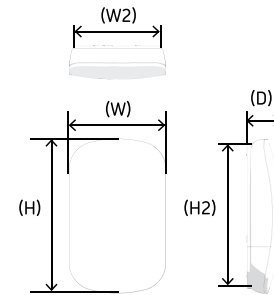

Physical Dimensions:

Height (H)	380mm
Width (W)	230mm
Depth (D)	85mm
Footprint Height (H2)	345mm
Footprint Width (W2)	210mm



Plumbing Supply:

Supply Source	Mains pressure cold water only
Minimum Dynamic Pressure	50kPa (0.5 Bar)
Maximum Static Pressure	1000 kPa (10 Bar)
Optimal Minimum Dynamic Pressure <i>(Recommended to ensure high performance)</i>	100 kPa (1 Bar)
Maximum Inlet Temperature	28°C
Minimum Inlet Temperature	2°C
Inlet Connection	15mm push-fit
Outlet Connection	1/2" BSP Male Thread Fitting
Water Ingress Rating	IPX4
Shower Drain Pump Connections	Suitable for AKW M Series

Electricity Supply:

Nominal Rating at	240 V 9.5kW & 8.5kW
Supply Fuse / Circuit Breaker	(9.5kW 40/45A) & (8.5kW 35/40A)
Residual Current Device (RCD)	30 mA (must be fitted)
Supply Cable	Refer to current wiring regulations and BS 7671 to determine minimum cable size. No larger than 10mm ²
Isolation Switch (e.g. Pull Cord)	45 Amp Double pole with 3mm
Water and Cable Entry Points	Top, bottom or back

Product Codes:

iTherm White 8.5kw Thermostatic Shower with Standard Kit	29024
iTherm White 9.5kw Thermostatic Shower with Standard Kit	29025

MIRA ELECTRIC SHOWERS

Mira Flex Shower 8.7kw



Manufacturer warranty applies

FEATURES

- + Thermostatic control and adjustable temperature safeguards
- + Extended lever control
- + Handset with raised areas to aid touch
- + Independent temperature and flow selection
- + Thermostatic control to +/- 1°C with adjustable maximum temperature limit
- + Extended 2m hose, 1m slide bar and additional handset holder
- + RNIB endorsed
- + Rate 11 litres max
- + Waste pump connectivity to all AKW waste pumps

Product Code:

Mira Flex Shower 8.7kw **25326**

TRITON ELECTRIC SHOWERS

Triton Safeguard Pumped Care



Manufacturer warranty applies

FEATURES

- + Pumped electric shower for low or negligible water pressures
- + Three stage thermostatic performance
- + Timed shower function
- + Minimum temperature set at 35°C
- + Push button start/stop with phased shutdown
- + Power and low flow indicators
- + Extended 1m riser rail
- + Waste pump connectivity to all AKW waste pumps

Product Code:

Triton Safeguard Pumped Care **25336**

Triton Omnicare 8.5kW Design with 1m Rail and 2m Hose



Manufacturer warranty applies

FEATURES

- + Audible feedback and tactile temperature dial with soft grey tones aids visually impaired users
- + Dual purpose grab rail
- + Reinforced riser rail kit designed to withstand up to 150kg / 23.5 stone
- + Co-ordinating lever handles creates a familiar and contemporary look
- + The Omnicare connects to both analogue and digital waste pumps
- + Multi pipe and cable entry points and a generous footprint
- + Easy replacement
- + Constantly regulates the water temperature to within +/- 1°C
- + Adjustable maximum water temperature
- + Adjustable shower duration

Product Code:

Triton Omnicare Thermostatic Shower **25327**

MIXER SHOWERS

Arka® Cool Touch Mixer Shower



This stylish modern mixer shower allows a safe and enjoyable experience whilst showering.

FEATURES

- + Extremely safe, chrome plated bar ensures the bar is cool to touch whilst water is flowing
- + Maximum set water temperature of 41°C
- + Provided with 1.5m hose, chrome finished shower head, stainless steel riser rail, chrome hose retainer and chrome brass mounting brackets
- + Easy to grip temperature and flow handles
- + Easy grip height adjustable handset holder to allow flexible shower head positioning
- + Rounded levers for safety
- + Rubber openings on the shower head to provide easy cleaning
- + Spiral wound stainless steel hose for easy cleaning
- + 600mm adjustable riser rail and soap dish
- + Safety setting of 38°C

Product Code:

Arka Cool Touch Mixer Shower & Kit	25440
Arka Care Mixer Shower	25420CH
Arka Cool Touch Care	25430CH

Technical Information

Minimum Dynamic Pressure	0.5 Bar
Maximum Dynamic Pressure	1 Bar
Maximum Static Pressure	10 Bar
Dimension for Fitting	150mm Inlet Centres
Water Entry	Back
Inlet Connectors	3/4" BSP
Approvals	TMV2, BC1545/0315, WRAS 1410905
Maximum Pre-Set Temperature	41/38°C
Approximate ECO Flow	8.5 Litres per Minute (when tested at 3 Bar)

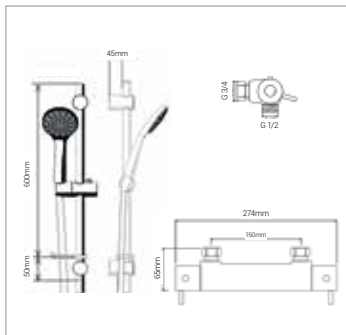

Arka® Thermostatic Mixer Shower



This chrome mixer shower is a great addition to any modern bathroom.

FEATURES

- + Reliable thermostatic performance supported by TMV3 approval
- + Easy to operate paddle levers, suitable for users of all abilities
- + Adjustable, easy clean head giving a choice of three spray patterns
- + Independently operated flow and temperature controls for safer use
- + Wall bracket allows flexible shower head positioning
- + Chrome soap dish means all your showering accessories are within easy reach
- + Brass body with chrome finish
- + Supplied with 2m chrome hose and 1m chrome riser bar giving extra manoeuvrability when showering
- + Fitted with check valves for backflow prevention
- + Maximum pre-set temperature of 41°C

Product Code:

Arka Thermostatic Mixer Shower	25420
--------------------------------	--------------

Optional: Arka Fixing Kits

Wall Mounted (Concealed)	25424
Surface Mounted (Exposed)	25423

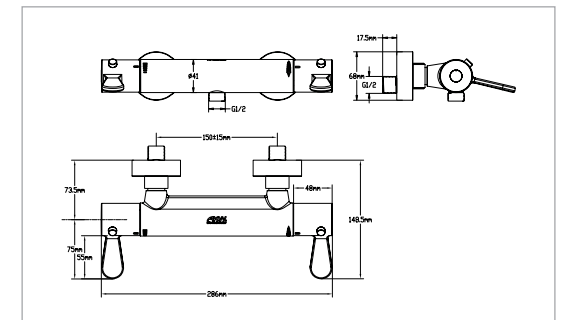

Arka® Care Mixer Shower



Easy Grip Shower Head



Soap Dish

Chrome mixer shower with additional care accessory kit gives ultimate style and support when showering.

FEATURES

- + Integral stainless steel grab riser rail for additional support and peace of mind
- + Easy grip shower head with grey rubber petals for quick spray pattern adjustment
- + 5 spray patterns settings for maximum showering comfort
- + Extended 2 metre shower hose ideal for assisted showering
- + Easy push buttons for shower head height adjustments
- + Soap dish and shelf included as standard and situated within easy reach for user
- + Additional shower head bracket for alternative positioning within the enclosure
- + Hose retaining ring included to prevent shower head being dropped and contaminated
- + 1 metre riser rail can support up to 150kg

Product Code:

Arka Care Mixer Shower **25420CH**

Arka® & Arka® Care Technical Information

Minimum Dynamic Pressure	0.5 Bar
Maximum Dynamic Pressure	1 Bar
Maximum Static Pressure	10 Bar
Dimension for Fitting	150mm Inlet Centres
Water Entry	Back
Inlet Connectors	3/4" BSP
Valve Type	Bar Valve with Dual Independent Thermo-static and Flow Control
Approvals	TMV3, WRAS, BSEN1111:1999, BSEN1287:1999
Maximum Pre-Set Temperature	41/38°C
Approximate ECO Flow	7-8.5 Litres per Minute (when tested at 3 Bar)
Maximum Flow	21 Litres per Minute (when tested at 3 Bar)



Extended options available

Vettora Thermo-static Mixer Shower



Stylish but simple, with the thermo-static control you'd expect from the UK's leading inclusive showering provider. This TMV2 thermo-statically controlled mixer shower embodies AKW's core values of safety, functionality and simplicity.

FEATURES

- + Clear flow and temperature indicators for ease of use
- + Easy grip levers for flow and temperature control
- + Shower valve supplied with multi-function shower head, hose, riser rail and all fixings
- + Contemporary chrome plated finish
- + Easy to clean
- + Temperature override button
- + Restricted flow option enhancing water conservation
- + Easy twist shower head

Product Code:

Vettora Mixer Shower **25658**

Technical Information

Minimum Dynamic Pressure	0.5 Bar
Maximum Dynamic Pressure	1 Bar
Maximum Static Pressure	10 Bar
Dimension for Fitting	150mm Inlet Centres
Concealed & Exposed Water Entry	Back
Inlet Connectors	3/4" BSP
Valve Type	Thermo-static Bar Shower Mixer with Independent Flow & Temperature Control
Approvals	TMV2, WRAS
Maximum Pre-Set Temperature	38°C
Maximum Pressure Difference (between Hot & Cold Water Supply)	1 Bar
Maximum Flow	34 Litres per Minute (when tested at 3 Bar)

Technical Drawings:

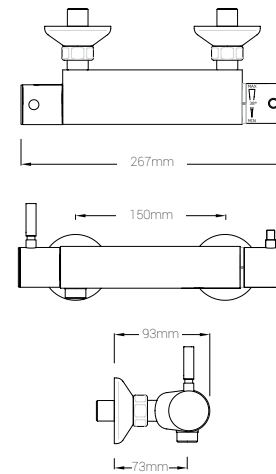



Walls & Floors

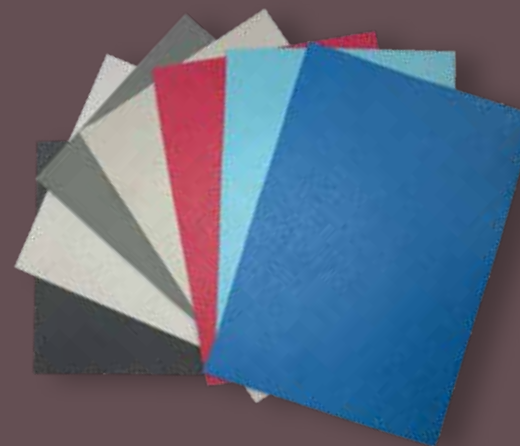

TILES AND ACCESSORIES **194**

Super White Bumpy Tiles	195
Tile Edge Trim & Strips	195
Tile Spacers	196
Tile Grout	196
Tile Adhesive	196

TIMBER **198**

CLS Timber 3"x2"	199
Plywood FSC Certified	199

SAFETY FLOORING **200**

Safety Flooring	200
Accessories	202

WALL PANELS **204**

Premium Wall Panels	207
Trade Range Wall Panels	205

Tiles & Accessories

Achieve a stylish and professional finish with AKW's range of tiles and tiling accessories for kitchens and bathrooms. From technically advanced tiles to grout and adhesive we've got it covered.



TILES & ACCESSORIES

Super White Bumpy Tiles



These super white bumpy tiles are the perfect choice for bathroom installations as they offer fantastic benefits, particularly for those who are visually impaired or who have dementia, due to the super white bumpy finish which allows maximum colour contrast to be achieved.

FEATURES & BENEFITS

- + Bumpy surface effect reduces glare which aids users with visual impairment or dementia.
- + Super white finish enhanced by zircon offers superior colour contrast to aid visually impaired
- + 3 different sizes to choose from
- + 7mm thick for extra stability and durability
- + Suitable for use on all internal domestic and commercial walls (kitchens, bathrooms etc.)
- + Easy clean wipeable finish

Product Code:

200 x 200mm (25 pack = 1m ²)	30074
200 x 250mm (20 pack = 1m ²)	30075
250 x 330mm (18 pack = 1.5m ²)	30076



Tile Edge Trim & Strips



- + Tile edging protects the edge of tiles from damage and neatly covers the unglazed tile edges
- + Transition strips provide a smooth transition between tiles and flooring for a clean, smart look
- + Tile edging is available in matte white to blend perfectly with all white tiles
- + Slightly rounded corners give a softer and neater edge to tiles for a professional finish.

Product Code:

Tile Edging Trim 3m/pc (pack of 10)	30072
Tile to Vinyl Floor Transition Strip 3m/pc (pack of 10)	30073

Tile Spacers



- + Tile spacers ensure perfect tile alignment and even grout lines
- + Can be cut to create 'T shaped' spacers
- + Made from tough durable plastic for re-use

Product Code:

2mm Tile Spacers (500 pack)	30069
3mm Tile Spacers (500 pack)	30070
4mm Tile Spacers (500 pack)	30071

Tile Grout



- + Specially formulated Steri-Grout
- + Antibacterial for sanitary installations
- + Formulated to be slump-free and flexible for quick application and easy filling of deep joints
- + Contains fungicide to inhibit black mould growth
- + Available in white
- + Drying time of 12-24 hours*

Product Code:

Bond It Steri-Grout for Floor & Wall Tiles (3kg Bag)	30077
--	--------------

* Dependent on site conditions

Tile Adhesive



- + Ready mixed polymer based adhesive
- + Suitable for fixing all types of ceramic wall tiles
- + 13kg tub offers a minimum coverage of 6m²
- + Standard drying time of 24-72 hours*
- + Superior grip properties ensure reduced slip and improved thin-bed coverage

Product Code:

Bond It Non-Slip Ceramic Wall Tile Adhesive 13kg	30078
--	--------------

* Dependent on site conditions



Timber

Our new range of timber and plywood is ideal for structural work, such as boxing, overboarding, floor supports, noggins or stud work for partitioned walls.



TIMBER

CLS Timber 3"x2"



FEATURES

- + Easy to cut and fit
- + Softwood planed with rounded edges
- + Ideal for interior framing, support and carcassing
- + Robust – provides stability and reliability
- + Strength graded to C16 specification
- + Treated timber is treated with tanalith

Product Code:

Timber 76mm (3in) x 50mm (2in) x 2400mm (96in) Untreated	21886
Timber 76mm (3in) x 50mm (2in) x 2400mm (96in) Treated	21887

Plywood FSC Certified BB/BB Grade



- + BB/BB graded plywood - good strength to weight ratio and suitable for structural work where face grade is not needed.
- + 100% FSC certified - wood is responsibly sourced, with a full chain of custody
- + Meets EN636 Specification Class 2 - suitable for humid conditions, primarily used for overboarding timber floors.
- + Structural strength and stability
- + WBP glue used - provides added safety of being water and boil proof
- + Available in a thickness of 4mm or 12mm

Product Code:

Plywood 1220mm x 2440mm x 4mm	21884
Plywood 1220mm x 2440mm x 12mm	21885
Plywood 1220mm x 2440mm x 18mm	21889

Safety Flooring

AKW Safety Flooring comes in a wide range of stylish colours and provides a high level of slip resistance in a bathroom adaptation.

100% watertight, durable and comfortable underfoot, it's ideal for all bathrooms.



SAFETY FLOORING

Safety Flooring



Anthracite



Slate



Dove



Cement



Rouge



Topaz



Cerulean

FEATURES & BENEFITS

- + Slip resistant even when barefoot
- + Light reflective value – Range includes plain and tonal chip options to help you achieve high contrast in care environment
- + Suitable for dementia users as there are no large speckles in the flooring which can cause confusion
- + Watertight, impervious surface – Fully bonded system that liquids cannot penetrate and has nowhere for bacteria to go
- + Easy to clean, the smooth surface of the flooring limits the build up of limescale
- + Long lasting, provides you with 10 years of guaranteed slip resistant flooring
- + PVC floor covering with glass fibre reinforced polyester cellulose backing which allows it to be used with underfloor heating
- + Phthalate free – plasticisers are based on natural resources
- + Cut to order, minimum order size is 2m x 0.5m

Product Code:

Anthracite LRV 10	21891-ANT
Slate LRV 18	21891-SLT
Dove LRV 38	21891-DVE
Cement LRV 55	21891-CMT
Rouge LRV 12	21891-RGE
Topaz LRV 33	21891-TPZ
Cerulean LRV 16	21891-CRL

ACCESSORIES

Bond-it Levelling Floor Compound



- + Self levelling – mix with water or latex liquid
- + Accepts floor traffic after 3-4 hours (depending on site conditions)
- + An easy-to-use pre-blended single pack ready to mix
- + Coverage – 20Kg bag will cover approximately 3.6m² at a depth of 3mm

Product Code:

20Kg

21896

Bond-it Latex Liquid



- + 1:1 Mix ratio - saving you time. For every 20kg pack of Levelmaster use 1 container of Latex Liquid.
- + 24 Month shelf life
- + Levelling compound/latex mix sets in 24 hours (depending on site conditions)

Product Code:

4.5L

21895

Bond-it Contact Adhesive



- + Single use component, no need to mix the adhesive, it is ready to use
- + High initial adhesion strength & final bond strength
- + Long open time – advisable to make bonds within 30 min.
- + Coverage: 2-3m² with spreader – 5-8m² when applied with a brush
- + Can be used for flooring or coving

Product Code:

5L

21894

3m Vinyl Flooring Coving

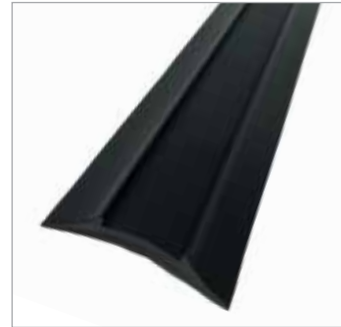

- + Provides a preformed radius for flooring installation
- + Installing the coving and dressing the flooring up the wall provides an end solution that is easy to clean
- + Colour: Black

Product Code:

Pack of Five – 3m length

30085

Flooring Weld Rod



- + Watertight and hygienic seam
- + Range of colours available either matching to floor colour or contrasting for an artistic touch
- + Solidified adhesive in rod application to easily melt into grooves and cuts to seal safety flooring
- + 1m lengths cut to order

Product Code:

Anthracite	21893-ANT
Slate	21893-SLT
Dove	21893-DVE
Cement	21893-CMT
Rouge	21893-RGE
Topaz	21893-TPZ
Cerulean	21893-CRL

Wall Panels

AKW has partnered with the UK's leading wall panel manufacturer Mermaid. Wall panels offer a number of benefits over tiling, including:

- + A more cost effective wall finish compared to tiling
- + Quicker to install
- + No grout means reduced mould
- + Available with antibacterial coating
- + Guaranteed to be watertight for 10 years



Concrete

TRADE RANGE WALL PANELS

Our trade panels are sold separately. Choose and order your desired panels (colour options below) then select the appropriate accessory kit for your requirements.

Trade Range Wall Panels



Stocked Colour Options**:



Non-Stocked Colour Options:

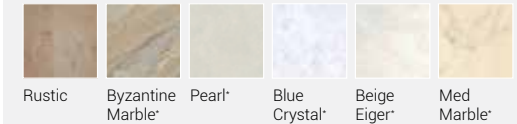

*Includes antibacterial coating

**Not all sizes are stocked

2-Sided Extrusion Kit for Tray Installation



i For installation on a wet or vinyl floor, an extruded bottom profile must also be ordered. **Product Code: 27170**

FEATURES

- + 2 End Caps, 1 Internal Corner, 2 Sealants, 2 Adhesives and 1 Transeal Kit

Product Codes:

White	27136	Satin Chrome	27138
Black	27140	Polished Chrome	27142

3-Sided Extrusion Kit for Tray Installation



i For installation on a wet floor, two extruded bottom profiles must also be ordered. **Product Code: 27170**

FEATURES

- + 2 End Caps, 2 Internal Corners, 3 Sealants, 3 Adhesives and 2 Transeal Kits

Product Codes:

White	27137	Satin Chrome	27139
Black	27141	Polished Chrome	27143

Trade Range Wall Panels (Technical Information)



Blue Crystal

i Our Wall Panel Fitting Guide can be found on [page 383](#)

i Please visit orders.akw-ltd.co.uk for Wall Board and Wall Board Accessories product codes

Range Specification:

Material	WBP Plywood
Method of manufacture	High pressure laminate bonding
Height	2420mm
Widths	1200mm Square Edged 900mm T&G Edges 600mm T&G Edges
Weights	29kg (1200mm width) 21kg (900mm width) 14kg (600mm width)
Thickness	9mm thick core laminate 0.7/0.8mm nominal 10.5mm finished board
Trimable	Yes
Warranty	10 years
Click and Lock	Yes
Coating	Antibacterial: This treatment eliminates up to 99.9% of bacteria from the surface of the panel

Panel Usage:

2420 x 1200mm Square Edged	Used for shower trays on single sides up to 1200mm
2420 x 900mm T&G Edges	Used for bath replacement scenarios to give 1800mm wall with minimum joints
2420 x 600mm T&G Edges	Used for all installations

Accessories Usage:

Adhesive	Used for sticking panels to wall in conjunction with mechanical fixings. Typically one tube per panel.
Sealant	Used to seal around all edges and ensure seal in profiles. Typically one tube per two panels.

PREMIUM WALL PANELS

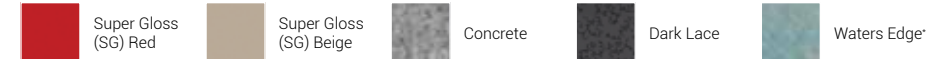

Premium Wall Panel Corner Kit: Two-Sided Installation



Product Codes: (Coordinating Profile / Chrome Profile)

900 x 900mm	900 x 1200mm	1200 x 1200mm
SG Red* 27145	SG Red* 27146	SG Red* 27147
SG Beige* 27150	SG Beige* 27151	SG Beige* 27152
Concrete 27155/27190	Concrete 27156/27191	Concrete 27157/27192
D/Lace 27160/27197	D/Lace 27161/27198	D/Lace 27162/27199
W/Edge 27165/27214	W/Edge 27166/27215	W/Edge 27167/27216

*Chrome only

Premium Wall Panel Wall Kit: Bathside Wall or Walk-In Shower Installation



FEATURES

- + Can be combined with one or two ends as required
- + Chrome Profiles

Product Codes:

One size to suit wall length up to 1789mm

SG Red 27148	Concrete 27193	Waters Edge 27217
SG Beige 27153	Dark Lace 27210	

Premium Wall Panel End Kit



i For installation on a wet floor, tiles or vinyl an extruded bottom profile must also be ordered. **Product Code: 27221**

FEATURES

- + Add an extra end to a corner or wall kit

Product Codes:

900mm End Kit	1200mm End Kit
SG Red 27149	SG Red 27188
SG Beige 27154	SG Beige 27189
Concrete 27194	Concrete 27195
Dark Lace 27211	Dark Lace 27212
Waters Edge 27218	Waters Edge 27219



Mobility Support

GRAB RAILS **210**

Heavy Duty Grab Rails	211
Plastic Grab Rails	213
Steel Grab Rails	217
T-Shaped Grab Rails	220
Hand Rails	220
Floor-to-Ceiling Support Poles	221
Fold-Up Rails	222

SHOWER SEATS **226**

Fold-Up Shower Seats	227
4000 Series Shower Seats	227
3000 Series Shower Seats	236
2000 Series Shower Seats	237
1000 Series Shower Seats	240
Bama Shower Seats	242
Hanging Shower Seats	243
Freestanding Shower Seats	244
Wooden Shower Seats	245

DOC M **246**

Doc M Packs	247
Doc M Washroom Products	251

MOBILITY RAMPS **256**

Folding Access Ramps	257
Threshold Ramps	258



Grab Rails

Our grab rail range offers a wide range of styles to ensure the appropriate level of support.



HEAVY DUTY GRAB RAILS

1900 Series Straight Heavy Duty Grab Rails



Physical Dimensions (mm):

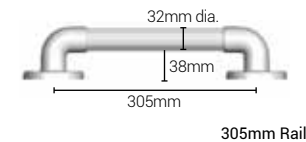

Registered Design: EU0000692249-0001

Reinforced with an aluminium tubular core for greater strength.

FEATURES

- + Tested to a maximum load of 190kg/30 stone**
- + Diameter: 32mm
- + A 38mm rail-to-wall clearance
- + Cannot be trimmed
- + Choice of 5 fixing points for optimum wall fixing
- + Fluted surface gives additional grip
- + Made from extruded plastic uPVC
- + Available in white, grey or blue for the visually impaired
- + No electrical earthing is required
- + Reinforced aluminium tubular core for greater strength

Product Codes:

305mm Heavy Duty Grab Rail	01900WH/BU/GR*
407mm Heavy Duty Grab Rail	01905WH/BU/GR*
457mm Heavy Duty Grab Rail	01910WH/BU*
610mm Heavy Duty Grab Rail	01920WH/BU/GR*
813mm Heavy Duty Grab Rail	01930WH/BU/GR*
914mm Heavy Duty Grab Rail	01940WH/BU/GR*
1067mm Heavy Duty Grab Rail	01950WH/BU/GR*

*WH/BU/GR in the product code denotes whether the rail is White, Blue or Grey.

**Maximum weight capacity refers to the grab rail only, not the user weight, fixings or retention in the mounting surface.

1900 Series Angled Heavy Duty Grab Rails



90° Heavy Duty Grab Rail (Blue)



135° Heavy Duty Grab Rail (Blue)

Registered Design: EU0000692249-0001

FEATURES

- + 90° angle and 135° angle grab rails are available
- + Tested to a maximum load of 190kg/30 stone**
- + Diameter: 32mm
- + A 38mm rail-to-wall clearance
- + Fluted surface gives additional grip
- + Made from extruded plastic uPVC
- + Available in white or blue for the visually impaired
- + No electrical earthing is required

Product Codes:

610x610mm Heavy Duty Grab Rail (90° Angle)	01925WH/BU*
455x455mm Heavy Duty Grab Rail (135° Angle)	01915WH/BU*

*WH/BU in the product code denotes whether the rail is White or Blue.

**Maximum weight capacity refers to the grab rail only, not the user weight, fixings or retention in the mounting surface.

PLASTIC GRAB RAILS

1600 Series Straight Natural Grip Plastic Grab Rails



i Five fixing points

FEATURES

- + Unique 'warm feel' polypropylene for comfort
- + Reinforced with a stainless steel (rust proof) core for added strength
- + A 46mm rail-to-wall clearance
- + Ergonomically designed with a distinctive grip
- + Tested to a maximum load of 125kg/19.5 stone*
- + Also available in white or blue for the visually impaired
- + No electrical earthing is required
- + Includes 5 fixing points for optimal strength

Product Codes:

300mm Natural Grip Grab Rail (32mm Diameter, Straight)	01600WH/BU*
300mm Natural Grip Grab Rail (35mm Diameter, Straight)	01650WH/BU*
450mm Natural Grip Grab Rail (32mm Diameter, Straight)	01610WH/BU*
450mm Natural Grip Grab Rail (35mm Diameter, Straight)	01660WH/BU*
600mm Natural Grip Grab Rail (32mm Diameter, Straight)	01620WH/BU*
600mm Natural Grip Grab Rail (35mm Diameter, Straight)	01670WH/BU*

*WH/BU in the product code denotes whether the rail is White or Blue.

**Maximum weight capacity refers to the grab rail only, not the user weight, fixings or retention in the mounting surface.

1600 Series Straight Natural Grip Plastic Grab Rails



FEATURES

- + Unique 'warm feel' polypropylene for comfort
- + Reinforced with a stainless steel (rust proof) core for added strength
- + A 46mm rail-to-wall clearance
- + Ergonomically designed with a distinctive grip
- + Tested to a maximum load of 125kg/19.5 stone**
- + Available in white (not 600x600mm) or blue for the visually impaired
- + No electrical earthing is required
- + Includes 5 fixing points for optimal strength

Product Codes:

600x600mm Natural Grip Grab Rail (32mm Diameter, 90° Angled)	01630WH/BU*
600x600mm Natural Grip Grab Rail (35mm Diameter, 90° Angled)	01680BU*
<i>Not available in white</i>	
450x450mm Natural Grip Grab Rail (32mm Diameter, 135° Angled)	01640WH/BU*

1400 Series Straight Plastic Grab Rails



FEATURES

- + A 59mm rail-to-wall clearance
- + Diameter: 32mm
- + Suitable for internal use
- + Fluted surface gives additional grip and is tested to a maximum load of 100kg/15.5 stone**
- + Made from high quality uPVC
- + Option of 5 fixing points for optimum wall fixing
- + Available in white, blue, yellow or mid-grey for the visually impaired
- + No electrical earthing is required

Product Codes:

300mm Straight Plastic Rail	01400WH/BU/YW*
450mm Straight Plastic Rail	01410WH/BU/YW*
600mm Straight Plastic Rail	01420WH/BU/YW*
300mm Mid Grey Rail	01400MG
450mm Mid Grey Rail	01410MG
600mm Mid Grey Rail	01420MG



*WH/BU in the product code denotes whether the rail is White or Blue.

**Maximum weight capacity refers to the grab rail only, not the user weight, fixings or retention in the mounting surface.

*WH/BU/YW in the product code denotes whether the rail is White, Blue or Yellow.

**Maximum weight capacity refers to the grab rail only, not the user weight, fixings or retention in the mounting surface.

1400 Series Angled Plastic Grab Rails



90° Plastic Grab Rail (Blue)



135° Plastic Grab Rail (Blue)

FEATURES

- + A 59mm rail-to-wall clearance
- + Diameter: 32mm
- + Suitable for internal use
- + Fluted surface gives additional grip and is tested to a maximum load of 100kg/15.5 stone**
- + Made from high quality uPVC
- + Option of 5 fixing points for optimum wall fixing
- + Available in white, blue or yellow for the visually impaired
- + No electrical earthing is required

Product Codes:

600x600mm Angled Plastic Grab Rail **01430WH/BU*** (90°)

450x450mm Angled Plastic Grab Rail **01440WH/BU*** (135°)

*WH/BU in the product code denotes whether the rail is White or Blue.

**Maximum weight capacity refers to the grab rail only, not the user weight, fixings or retention in the mounting surface.

STEEL GRAB RAILS

Stainless Steel Straight Grab Rails



FEATURES

- + Made from high grade stainless steel
- + Polished finish
- + Diameter: 32mm
- + 3 fixing points
- + Captive flange covers
- + 56mm rail to wall clearance
- + Tested to a maximum load of 150kg/23.5 stone*

Product Codes:

300mm Stainless Steel Straight Grab Rail **01230**

450mm Stainless Steel Straight Grab Rail **01231**

600mm Stainless Steel Straight Grab Rail **01232**

Epoxy Coated Stainless Steel Straight Grab Rail



FEATURES

- + Available in Mid Grey or White
- + 3 fixing points for added security
- + Tested to a maximum load of 150kg/23.5 stone
- + Lifetime warranty
- + 56mm rail to wall clearance
- + Easy to clean
- + Captive flange covers

Product Codes:

300mm Mid Grey SS Grab Rail **01240MG**

450mm Mid Grey SS Grab Rail **01241MG**

600mm Mid Grey SS Grab Rail **01242MG**

300mm White SS Grab Rail **01240WH**

450mm White SS Grab Rail **01241WH**

600mm White SS Grab Rail **01242WH**

*Maximum weight capacity refers to the grab rail only, not the user weight, fixings or retention in the mounting surface.

1200 Series Flat End Straight Stainless Steel Grab Rails



FEATURES

- + Flat ended stainless steel tubular grab rail
- + Suitable for internal or external usage
- + Available in white or brown polyester epoxy powder coating
- + Colour options provide discrete external appearance
- + Diameter: 25mm
- + A 43mm rail-to-wall clearance
- + 2 hole fixings on each end
- + ASTM B117-87 96 hour salt spray tested
- + Lifetime warranty on stainless steel

Product Codes:

305mm Flat End Steel Grab Rail	01200WH/BR*
445mm Flat End Steel Grab Rail	01210WH*
610mm Flat End Steel Grab Rail	01220WH/BR*

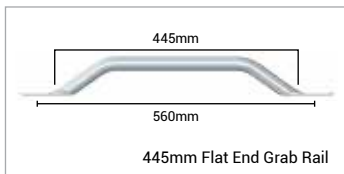

*WH/BR in the product code denotes whether the rail is White or Brown.

1000 Series Flat End Straight Mild Steel Grab Rails



FEATURES

- + Flat ended mild steel tubular grab rail
- + Available in white polyester epoxy powder coating
- + Coating process includes rust inhibitor treatment
- + Diameter: 25mm
- + A 43mm rail-to-wall clearance and 1.2mm wall thickness
- + 2 hole fixings on each end
- + ASTM B117-87 96 hour salt spray tested

Product Codes:

305mm Flat End Steel Grab Rail	01000E
445mm Flat End Steel Grab Rail	01010E
610mm Flat End Steel Grab Rail	01020E

1700 Series Flat End Cranked Steel Grab Rails



FEATURES

- + Offset design allows the user to step up to and through the doorway without releasing the grip
- + Diameter: 26.7mm
- + Spacious design avoids hand grazing
- + Available in white or brown
- + White rail is manufactured from a longer lasting cold drawn mild steel tube
- + Brown rail is manufactured from stainless steel (201 grade)
- + Suitable for all internal applications, except for bath & shower rooms
- + Powder coated finishing process includes rust inhibitor treatment

Product Codes:

445mm Stainless Steel Grab Rail White	01760
445mm Stainless Steel Grab Rail Brown	01770
630mm Stainless Steel Grab Rail White	01750

T-SHAPED GRAB RAILS

T-Shape SS Epoxy Coated Grab Rail



FEATURES

- + 1200 x 300 x 300mm T-Shape Grab Rail
- + White
- + Stainless Steel Epoxy coated

Product Code:

T-Shaped SS Epoxy Coated Grab Rail **01246WH**

HAND RAILS

Newel Hand Rail



FEATURES

- + 90° turn around the newel post
- + Provides additional grip while using the stairs
- + Diameter: 32mm
- + Length: 707mm
- + Made from cold drawn mild steel tube
- + Finishing process includes rust inhibitor treatment
- + 3 hole fixing flange
- + Available left or right-handed
- + Tested to ASTM B117-87 salt spray test
- + White epoxy resin coated

Product Code:

Newel Hand Rail White **01745L/R**

L/R in the product code denotes whether the rail is Left or Right handed.

FLOOR-TO-CEILING SUPPORT POLES

Floor-to-Ceiling Support Pole



FEATURES

- + Diameter: 37mm
- + Length: 2750mm
- + Made from mild steel and ribbed PVC
- + Polycoated plates – 3 fixing points
- + Trim-to-length to suit ceiling height

Product Code:

Floor-to-Ceiling Support Pole **01720**

Floor-to-Ceiling Support Pole with 500mm Stay

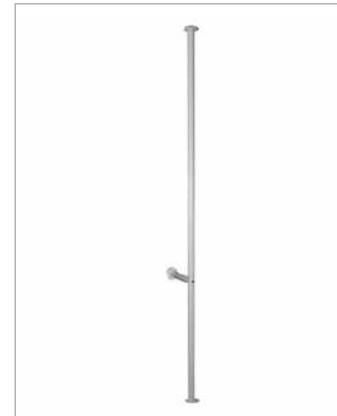

FEATURES

- + Diameter: 32mm
- + Length: 2750mm with 500mm stay
- + Made from aluminium
- + Plastic (ABS) fixings – 4 fixing points
- + Trim-to-length to suit ceiling height
- + Stay is trimmable and height is adjustable

Product Code:

Floor-to-Ceiling Support Pole with Stay **01730**

FOLD-UP RAILS

Fold-Up Double Support Rail



FEATURES

- + Available in white or blue for users with impaired vision
- + Supplied with optional fit toilet roll holder
- + Tested to a maximum load of 100kg/15½ stone**

Product Code:

Fold-Up Double Support Rail **01810WH/BU***

Physical Dimensions (mm):

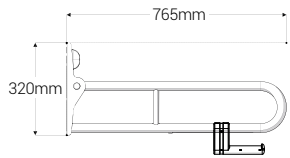

Fold-Up Double Support Rail with Leg



FEATURES

- + Available in white or blue for users with impaired vision
- + Supporting leg gives additional strength and stability
- + Leg can be cut down to length
- + Height to top of rail: 680mm
- + Supplied with optional fit toilet roll holder
- + Tested to a maximum load of 200kg/30 stone**

Product Code:

Fold-Up Double Support Rail with Leg **01820WH/BU***

Physical Dimensions (mm):

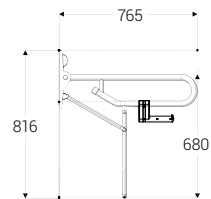

*WH/BU in the product code denotes whether the rail is White or Blue.

**Maximum weight capacity refers to the grab rail only, not the user weight, fixings or retention in the mounting surface.

1800 Series Fold-Up Rail



Blue

FEATURES

- + Strong design for additional support
- + Folds neatly back to the wall to maximise space
- + Ideal for use in multi-user bathrooms
- + Epoxy resin coating and rust inhibitor treatment for longer life
- + Made from 32mm diameter steel projecting 765mm from wall
- + Tested to ASTM B117-87 salt spray test
- + Supplied with optional fit toilet roll holder
- + Available in blue for users with impaired vision

Product Code:

1800 Series Blue Fold-Up Rail **01830BU**

1800 Series Mid Grey Fold-up Rail **01830MG**



Supplied with optional toilet roll holder



Mid Grey

Polished Stainless Steel Fold-Up Rail with Adjustable Leg



FEATURES

- + Fold-up design gives you more room, especially where space is limited
- + Ideal for multi-user environments
- + An adjustable supporting leg ensures added strength and stability
- + Supporting leg adjusts in 25mm increments
- + Integral stainless steel toilet roll holder
- + Diameter: 32mm
- + Height to top of rail: 680-880mm
- + +/- 13mm fine adjustment to foot of support leg
- + Tested to a maximum load of 200kg/30 stone*

Product Code:

Stainless Steel Fold-Up Rail
(with Adjustable Leg)

01830SS

Physical Dimensions (mm):

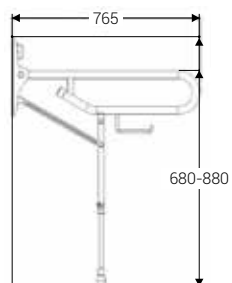

Fold-Up Double Support Rail with Adjustable Leg



FEATURES

- + Available in white
- + Supporting leg for additional strength and stability
- + Supporting leg adjusts in 25mm increments
- + Height to top of rail: 680-880mm
- + +/- 13mm fine adjustment to foot of support leg
- + Supplied with optional fit toilet roll holder
- + Tested to a maximum load of 200kg/30 stone*

Product Code:

Fold-Up Double Support Rail
(with Adjustable Leg)

01830WH

Physical Dimensions (mm):

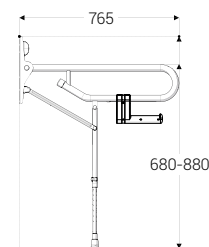

*Maximum weight capacity refers to the grab rail only, not the user weight, fixings or retention in the mounting surface.

*Maximum weight capacity refers to the grab rail only, not the user weight, fixings or retention in the mounting surface.

Shower Seats

AKW offers a wide range of shower seats which have been developed in consultation with occupational therapists, end users and installers to ensure functionality and safety without a compromise in style.



FOLD-UP SHOWER SEATS

4000 Series Standard Fold-Up Shower Seat – 40 Stone Stainless Steel

4000 Series shower seats have been designed to accommodate a variety of individual needs, with options including backrests, padded arms and adjustable legs.



FEATURES

- + Designed in consultation with occupational therapists, end users and installers
- + Adjustable for comfort, with seat heights of between 390–640mm (provided by two sets of leg height supplied as standard)
- + Width: 460mm
- + Sturdy design, carries weight up to 254kg/40 stone
- + +/- 13mm fine adjustment to foot or support leg to allow for gradient in floor
- + Unique and innovative design will give years of trouble free service
- + Made from rust proof stainless steel
- + Available in white and with a grey or blue padded seat

Physical Dimensions (mm):

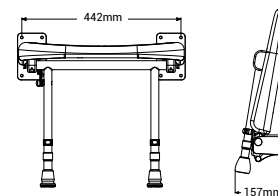
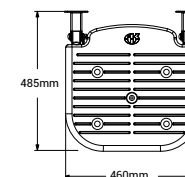
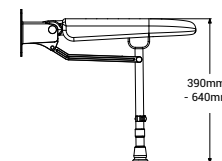

Product Codes:

Standard Shower Seat White	04070
Standard Shower Seat Blue Padded	04070P
Standard Shower Seat Grey Padded	04270P
Spare Seat Cushion Blue	04170
Spare Seat Cushion Grey	04270



4000 Series Extra-Wide Fold-Up Shower Seat – 40 Stone Stainless Steel



Physical Dimensions (mm):

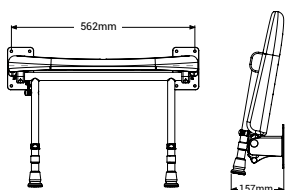
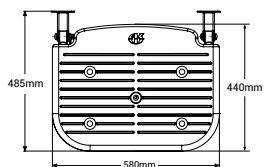
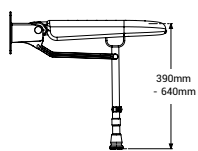

FEATURES

- + Designed in consultation with occupational therapists, end users and installers
- + Adjustable for comfort, with seat heights of between 390–640mm (provided by two sets of leg height supplied as standard)
- + Sturdy design, carries weight up to 40 stone / 254kg
- + +/- 13mm fine adjustment to foot or support leg to allow for gradient in floor
- + Unique and innovative design will give years of trouble free service
- + Made from rust proof stainless steel
- + Available in white and with a grey or blue padded seat

Product Codes:

580 Wide Shower Seat White	04110
580 Wide Shower Seat Blue Padded	04110P
580 Wide Shower Seat Grey Padded	04210P
580 Wide Spare Seat Cushion Blue	04175
580 Wide Spare Seat Cushion Grey	04275



4000 Series Large Extra Wide Fold-Up Shower Seat – 50 Stone Stainless Steel



FEATURES

- + Specifically designed to offer choice to larger clients
- + Extra comfort, space and support
- + Extensive range of extra wide shower seats offering additional space when showering
- + Sturdy design, carries weight limit up to 50 stone/317.5kg
- + Available in white and with a grey or blue padded seat

Product Codes:

660 Wide Shower Seat White	04570
660 Wide Shower Seat Blue Padded	04580P
660 Wide Shower Seat Grey Padded	04570P
660 Wide Spare Seat Cushion Blue	04585
660 Wide Spare Seat Cushion Grey	04575



4000 Series Standard Horseshoe Fold-Up Shower Seat – 40 Stone Stainless Steel



FEATURES

- + Designed in consultation with occupational therapists, end users and installers
- + Adjustable for comfort, with seat heights of between 390–640mm (provided by two sets of leg height supplied as standard)
- + Width: 460mm
- + Sturdy design, carries weight up to 254kg/40 stone
- + +/- 13mm fine adjustment to foot or support leg to allow for gradient in floor
- + Unique and innovative design will give years of trouble free service
- + Made from rust proof stainless steel
- + Available in white and with a grey or blue padded seat

Product Codes:

Horseshoe Shower Seat White	04100
Horseshoe Shower Seat Blue Padded	04100P
Horseshoe Shower Seat Grey Padded	04200P
Spare Horseshoe Seat Cushion Blue	04180
Spare Horseshoe Seat Cushion Grey	04280



Physical Dimensions (mm):

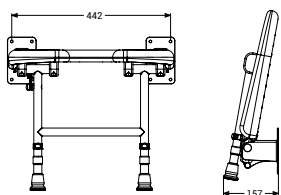
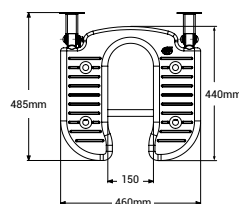
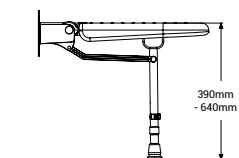

Drawings are for illustrative purposes only. Standard & horseshoe shower seats are the same dimensions.

4000 Series Extra Wide Horseshoe Fold-Up Shower Seat – 40 Stone Stainless Steel



FEATURES

- + Designed in consultation with occupational therapists, end users and installers
- + Adjustable for comfort, with seat heights of between 390–640mm (provided by two sets of leg height supplied as standard)
- + Width: 580mm
- + Sturdy design, carries weight up to 254kg/40 stone
- + +/- 13mm fine adjustment to foot or support leg to allow for gradient in floor
- + Unique and innovative design will give years of trouble free service
- + Made from rust proof stainless steel
- + Available in white and with a grey or blue padded seat

Product Codes:

Wide Horseshoe Shower Seat White	04120
Wide Horseshoe Shower Seat Blue Padded	04120P
Wide Horseshoe Shower Seat Grey Padded	04220P
Spare Horseshoe Seat Cushion Blue	04185
Spare Horseshoe Seat Cushion Grey	04285



Physical Dimensions (mm):

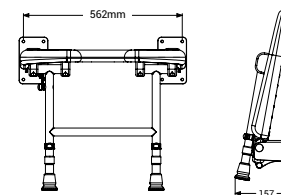
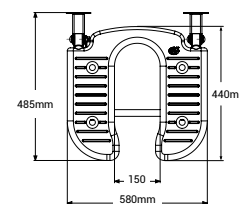
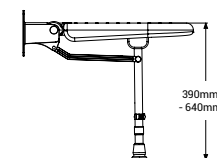

Drawings are for illustrative purposes only. Standard & horseshoe shower seats are the same dimensions.

4000 Series Standard Fold-Up Shower Seat with Back & Arms – 40 Stone Stainless Steel



Physical Dimensions (mm):

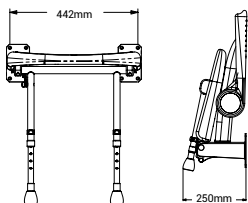
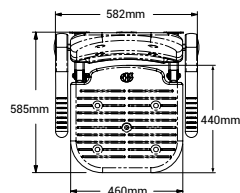
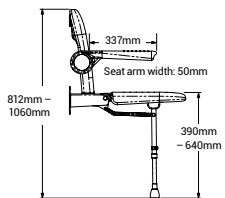

Drawings are for illustrative purposes only. Standard & horseshoe shower seats are the same dimensions.

FEATURES

- + Designed in consultation with occupational therapists, end users and installers
- + Independent folding arms make it suitable for side transfers
- + Adjustable for comfort, with seat heights of between 390–640mm (provided by two sets of leg height supplied as standard)
- + Width: 460mm
- + Sturdy design, carries weight up to 254kg/40 stone
- + +/- 13mm fine adjustment to foot or support leg to allow for gradient in floor
- + Unique and innovative design will give years of trouble free service
- + Made from rust proof stainless steel
- + Available in white and with a grey or blue padded back/seat

Product Codes:

White Standard Shower Seat with Blue Arms	04130
White Standard Shower Seat with Grey Arms	04230
Blue Padded Standard Shower Seat (with Blue Arms)	04130P
Grey Padded Standard Shower Seat (with Grey Arms)	04230P
Spare Seat Back Blue	04190
Spare Seat Back Grey	04290
Spare Seat Cushion Blue	04170
Spare Seat Cushion Grey	04270



4000 Series Extra Wide Fold-Up Shower Seat with Back & Arms – 40 Stone Stainless Steel



Physical Dimensions (mm):

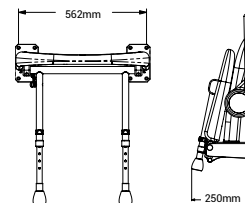
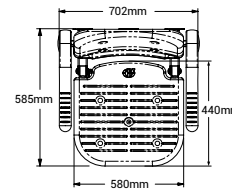
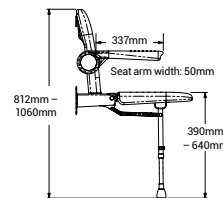

Drawings are for illustrative purposes only. Standard & horseshoe shower seats are the same dimensions.

FEATURES

- + Designed in consultation with occupational therapists, end users and installers
- + Independent folding arms make it suitable for side transfers
- + Adjustable for comfort, with seat heights of between 390–640mm (provided by two sets of leg height supplied as standard)
- + Width: 580mm
- + Sturdy design, carries weight up to 254kg/40 stone
- + +/- 13mm fine adjustment to foot or support leg to allow for gradient in floor
- + Unique and innovative design will give years of trouble free service
- + Made from rust proof stainless steel
- + Available in white and with a grey or blue padded back/seat

Product Codes:

White Wide Shower Seat with Blue Arms	04140
White Wide Shower Seat with Grey Arms	04240
Blue Padded Wide Shower Seat (with Blue Arms)	04140P
Grey Padded Wide Shower Seat (with Grey Arms)	04240P
Spare Seat Back Blue	04195
Spare Seat Back Grey	04295
Spare Seat Cushion Blue	04175
Spare Seat Cushion Grey	04275



4000 Series Standard Horseshoe Fold-Up Shower Seat with Back & Arms – 40 Stone SS



FEATURES

- + Designed in consultation with occupational therapists, end users and installers
- + Independent folding arms make it suitable for side transfers
- + Adjustable for comfort, with seat heights of between 390–640mm (provided by two sets of leg height supplied as standard)
- + Width: 460mm
- + Sturdy design, carries weight up to 254kg/40 stone
- + +/- 13mm fine adjustment to foot or support leg to allow for gradient in floor
- + Unique and innovative design will give years of trouble free service
- + Made from rust proof stainless steel
- + Available in white and with a grey or blue padded back/seat

Product Codes:

White Horseshoe Shower Seat with Blue Arms	04160
White Horseshoe Shower Seat with Grey Arms	04260
Blue Padded Horseshoe Shower Seat (with Blue Arms)	04160P
Grey Padded Horseshoe Shower Seat (with Grey Arms)	04260P
Spare Horseshoe Seat Cushion Blue	04180
Spare Horseshoe Seat Cushion Grey	04280



Physical Dimensions (mm):

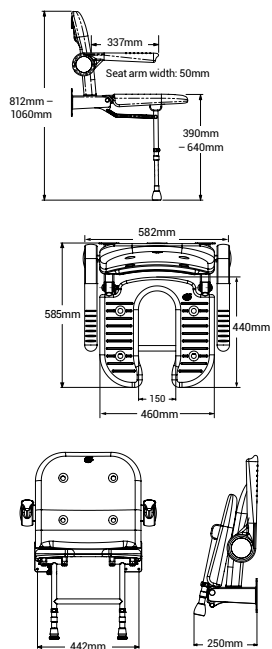

Drawings are for illustrative purposes only. Standard & horseshoe shower seats are the same dimensions.

4000 Series Extra Wide Horseshoe Fold-Up Shower Seat with Back & Arms – 40 Stone SS



FEATURES

- + Designed in consultation with occupational therapists, end users and installers
- + Independent folding arms make it suitable for side transfers
- + Adjustable for comfort, with seat heights of between 390–640mm (provided by two sets of leg height supplied as standard)
- + Width: 580mm
- + Sturdy design, carries weight up to 254kg/40 stone
- + +/- 13mm fine adjustment to foot or support leg to allow for gradient in floor
- + Unique and innovative design will give years of trouble free service
- + Made from rust proof stainless steel
- + Available in white and with a grey or blue padded back/seat

Product Codes:

White Wide Horseshoe Shower Seat (with Blue Arms)	04150
Blue Padded Wide Horseshoe Shower Seat (with Blue Arms)	04150P
Grey Padded Wide Horseshoe Shower Seat (with Grey Arms)	04250P
Spare Horseshoe Seat Cushion Blue	04185
Spare Horseshoe Seat Cushion Grey	04285



Physical Dimensions (mm):

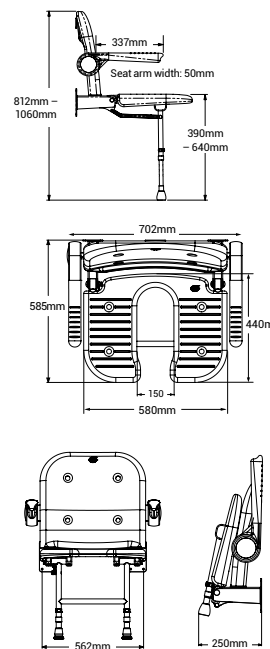

Drawings are for illustrative purposes only. Standard & horseshoe shower seats are the same dimensions.

3000 Series Standard Shower Seat – 30 stone Mild Steel



FEATURES

- + Made from powder coated mild steel
- + Available with or without seat and back padding
- + Comfortable in use
- + For users up to 190kg / 30 stone
- + + or - 13mm fine adjustment to support leg to allow for gradient in floor
- + Adjustable for comfort, with seat heights of between 450mm – 625mm
- + Soft feel padding, made from soft feel polyurethane which will not absorb water even if cut or damaged.
- + Two mounting brackets for reassurance of superior wall fixing
- + Shrouded hinges to minimise the risk of finger trapping for both carer and user
- + Only available with grey seat and back pads

Product Codes:

White seat/Grey arms	03131
Padded Grey seat/Grey arms	03131P
Spare back pad for 3000 series seat	03132
Spare seat pad for 3000 series seat	03133
Spare arm set for 3000 series seat	03134



Physical Dimensions (mm):

Mounting Hole Dimensions

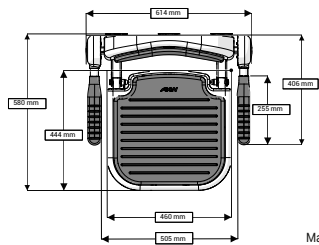
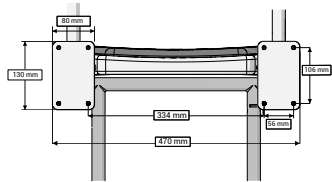

Maximum Height Dimensions

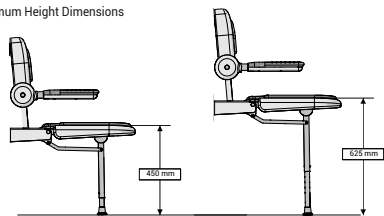

Seat Dimensions

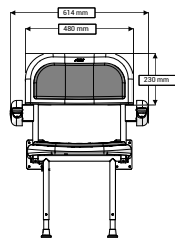

Folded Dimensions

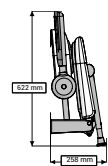

2000 Series Compact Fold-Up Shower Seat – 25 Stone Aluminium

2000 Series shower seats are carefully designed, comfortable and rust-proof. The compact option is designed for smaller enclosures, where space is limited.



FEATURES

- + Made from rust proof aluminium
- + Compact option, designed for smaller enclosures and where space is limited
- + Comfortable in use
- + Adjustable seat height: 482-607mm
- + For users up to 158kg/25 stone
- + +/- 13mm fine adjustment to support leg to allow for gradient in floor
- + Available in white and with a grey or blue padded back/seat

Product Codes:

Compact Shower Seat White	02000
Compact Shower Seat Blue Padded	02200P
Compact Shower Seat Grey Padded	02000P
Spare Seat Cushion Blue	02015
Spare Seat Cushion Grey	02215

Physical Dimensions (mm):

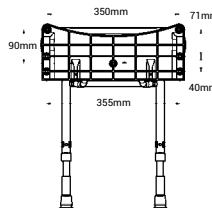
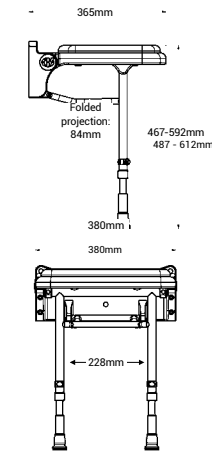

Please note: 2000 Series seats are not supplied with an extra pair of legs.

2000 Series Standard Fold-Up Shower Seat – 25 Stone Aluminium



FEATURES

- + Made from rust proof aluminium
- + Comfortable in use
- + Adjustable seat height: 482-607mm
- + For users up to 158kg/25 stone
- + +/- 13mm fine adjustment to support leg to allow for gradient in floor

Product Codes:

Standard Shower Seat White	02010
Standard Shower Seat Blue Padded	02210P
Standard Shower Seat Grey Padded	02010P
Spare Seat Cushion Blue	02011
Spare Seat Cushion Grey	02211



Physical Dimensions (mm):

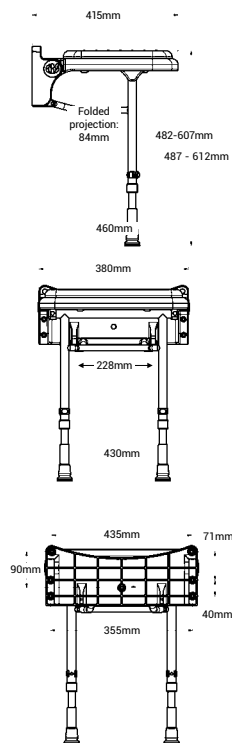

2000 Series Standard Fold-Up Shower Seat with Back & Arms – 25 Stone Aluminium



FEATURES

- + Made from rust proof aluminium
- + Comfortable in use
- + Adjustable seat height: 482-607mm
- + For users up to 158kg/25 stone
- + +/- 13mm fine adjustment to support leg to allow for gradient in floor
- + Available in white and with a grey or blue padded back/seat

Product Codes:

White Standard Shower Seat with Grey Arms	02130
White Standard Shower Seat with Blue Arms	02230
White Standard Shower Seat (with Grey Arms & Back)	02130P
White Standard Shower Seat (with Blue Arms & Back)	02230P
Spare Seat Cushion Blue	02011
Spare Seat Cushion Grey	02211
Spare Back Cushion Blue	02212
Spare Back Cushion Grey	02112



Physical Dimensions (mm):

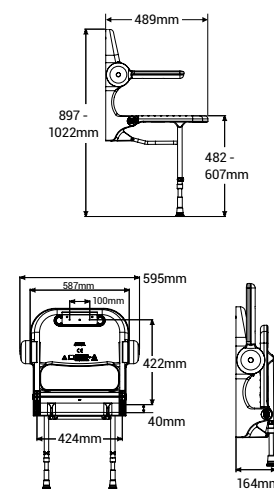

Please note: 2000 Series seats are not supplied with an extra pair of legs.

1000 Series Standard Shower Seat – 25 Stone Mild Steel



FEATURES

- + Padded backrest in a choice of grey or blue padding
- + Comfortable in use
- + For users up to 158kg / 25 stone
- + + or - 13mm fine adjustment to support leg to allow for gradient in floor
- + Adjustable for comfort, with seat heights of between 450mm - 625mm
- + Soft feel padding, made from soft feel polyurethane which will not absorb water
- + Two mounting brackets for reassurance of superior wall fixing
- + Shrouded hinges to minimise the risk of finger trapping for both carer and user
- + Blue pad option available to offer high contrast seating for visually impaired users
- + Material: Mild Steel

Physical Dimensions (mm):

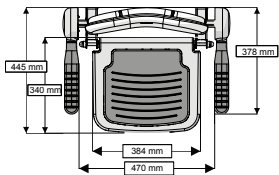

Folded Dimensions

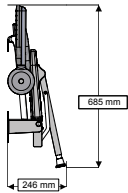

Minimum Height Dimensions

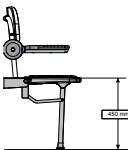

Maximum Height Dimensions

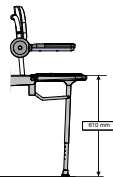

Product Codes:

Padded Grey seat/Grey arms	01122
Padded Blue seat/Blue arms	01123
Spare arm, back and seat pad kit – Grey	01112
Spare arm, back and seat pad kit – Blue	01113

Please note: 2000 Series seats are not supplied with an extra pair of legs.

Onyx Fold-up Shower Seat – 31 Stone



FEATURES

- + Minimalistic, contemporary design
- + Ergonomic seat with matt finish
- + Strength (31 Stone, 6lb / 200kg)
- + Water draining slot
- + Single Fold down leg
- + Lifetime warranty
- + Easy installation
- + Easy cleaning

Product Codes:

Onyx Fold-up Shower Seat – Black	02800BK
Onyx Fold-up Shower Seat – White	02800WH



Bama Slatted Fold-Up Shower Seat – 31 Stone



A slatted shower seat which provides seated safety in the shower area and stylish design in slate grey or white. Capable of supporting up to 200kg (31st 6lb) with height adjustable legs, the fold-up design saves space when not in use.

FEATURES

- + Safe showering whilst seated
- + Stylish, hygienic, easy to clean and folds neatly away
- + Ideal for social housing and adaptations
- + Handles for easier side transfer
- + Curved raised slats allow water run-off to drain
- + Rounded corners with no sharp edges to catch exposed skin
- + Maximum load capacity: 200kg (31st 6lb)
- + Made from ABS (plastic), Nylon and epoxy coated Stainless Steel tube
- + 7 white or slate grey removable slats for easy cleaning
- + Stainless steel legs
- + Seat height: 480mm +/- 15mm (adjustable legs)
- + Width: 490mm, Depth: 409mm
- + 4 strong fixing points

Product Codes:

Bama Slatted Fold-Up Shower Seat White	02020WH
Bama Slatted Fold-Up Shower Seat Slate Grey	02020GR



HANGING SHOWER SEATS

Bama Slatted Hanging Shower Seat – 23 Stone



A shower seat which can be hung on a grab rail. Supports up to 150kg (23st 8lb), providing easy to install seated safety in the shower area and stylish design.

FEATURES

- + Safe showering whilst seated
- + Stylish, hygienic, easy to clean
- + Ideal for hotels, hospitals and public buildings
- + Easy to install/remove, for multi-user bathrooms
- + Curved raised slats allow water run-off to drain
- + Rounded corners with no sharp edges to catch exposed skin
- + Shower seat can be hung on straight smooth grab rails (32mm diameter) with suitable load bearing, lockable
- + Maximum load capacity: 150kg (23st 8lb)
- + Back frame foot adjustment 25mm
- + Made from ABS (plastic), Nylon and epoxy coated Stainless Steel tube
- + Simple stylish design
- + Easy locking system
- + Width: 387mm, Height: 390mm, Depth: 514mm
- + Foam sleeve for hooks protects the grab rail

Product Code:

Bama Hanging Shower Seat White	02021WH
--------------------------------	----------------



FREESTANDING SHOWER SEATS

Freestanding Shower Stool



FEATURES

- + Plasticised PVC suction feet provide added stability and security
- + Adjustable aluminium legs and drain holes allow the product to dry easily after use
- + Supplied flat packed in kit form
- + Width: 500mm, Depth: 300mm, Height: 350-500mm
- + Tested to a maximum load of 127kg/20 stone

Product Code:

Freestanding Shower Stool

02300



Freestanding Shower Stool with Back



FEATURES

- + A back support gives extra comfort
- + Plasticised PVC suction feet provide added stability and security
- + Adjustable aluminium legs and drain holes allow the product to dry easily after use
- + Supplied flat packed in kit form
- + Width: 500mm, Depth: 300mm, Seat back: 340mm, Seat height: 350-500mm
- + Tested to a maximum load of 127kg/20 stone

Product Code:

Freestanding Shower Stool with Back

02310



WOODEN SHOWER SEATS

Wooden Slatted Fold-Up Seat with Support Legs –40 Stone Stainless Steel



FEATURES

- + Made from ecologically friendly rubberwood (dense grain)
- + Very stable with minimal shrinkage
- + Profiled edges are varnished to give greater comfort and durability
- + Framework and legs made from rust proof stainless steel (lifetime warranty)
- + Suitable for users up to 40 stone/254kg in weight
- + Seat height adjustment: 390-640mm
- + Width: 442mm, Depth: 478mm

Product Code:

Wooden Slatted Fold-Up Seat

04030



on
framework
& legs

Wooden Shower Stool



FEATURES

- + Made from ecologically friendly rubberwood (dense grain)
- + Very stable with minimal shrinkage
- + Tested to BS EN 15373:2007
- + Profiled edges are varnished to give greater comfort and durability
- + Framework and legs made from rust proof stainless steel (lifetime warranty)
- + Suitable for users up to 40 stone/254kg
- + Adjustable legs allow 25mm increments between 410mm and 535mm
- + Width: 555mm, Depth: 372mm

Product Code:

Wooden Shower Stool

05080

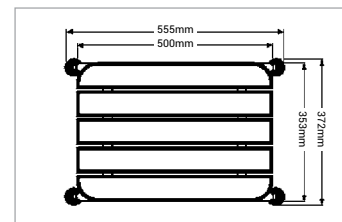

on
framework
& legs

Doc M

Purpose designed to comply with the latest building regulations relating to special needs, AKW's DOC M range offers quality and choice.



DOC M PACKS



Pack 1: Fully Compliant Close Coupled Doc M Pack



TMV3 Thermostatic Sequential Mixer Tap



Fold-Up Blue Grab Rail



Alarm & Pull Cord



Large Paper Towel Dispenser

PACK INCLUDES

- + 2 tap hole wall mounted wash basin
- + TMV3 Thermostatic sequential mixer tap
- + Easy operational flush handle (full flush: 6l, reduced flush: 4l)
- + Raised height WC
- + Blue ergonomic soft-closing toilet seat with lid
- + Close coupled cistern with screw down lid
- + Blue grab rails
- + Blue fold up grab rail
- + Liquid soap dispenser
- + Hand drier – 2.3kW
- + Large paper towel dispenser
- + Toilet tissue dispenser
- + One small & one large white polypropylene shelf
- + Alarm & pull cord
- + Mirror with toughened glass
- + 2 clothes hooks
- + Swing bin



Electrical Warranty



See product details for specific approvals

Fully compliant to BS8300:2009

Please note: all items are available separately.

Product Code:

Doc M Pack 1

23200

Order: 01905 823 299 | orders.akw-ltd.co.uk

Technical support: 01905 560 219

247



Pack 2: Fully Compliant Low Level Doc M Pack



Toilet Tissue Dispenser



Swing Bin



Liquid Soap Dispenser



Hand Drier

PACK INCLUDES

- + 2 tap hole wall mounted wash basin
- + TMV3 Thermostatic sequential mixer tap
- + Easy operational flush handle (full flush: 6l, reduced flush: 4l)
- + Raised height WC with padded back rest
- + Blue ergonomic soft-closing toilet seat with lid
- + Low level cistern with screw down lid
- + Blue grab rails & fold up grab rail
- + Liquid soap dispenser
- + Hand drier – 2.3kW
- + Large paper towel dispenser
- + Toilet tissue dispenser
- + One small & one large white polypropylene shelf
- + Alarm & pull cord
- + Mirror with toughened glass
- + 2 clothes hooks
- + Swing bin
- + Large semi-pedestal for 550mm basins

Product Code:

Doc M Pack 2 **23201**



Electrical Warranty



See product details for specific approvals

Please note: all items are available separately.

Pack 3: Standard Close Coupled Doc M Pack



2 Tap Hole Finger Rinse Wash Basin



White Natural Grip Fluted Grab Rail



Blue Toilet Seat



Raised Height WC

PACK INCLUDES

- + 2 tap hole wall mounted wash basin
- + Monobloc spray mixer tap
- + Easy operation flush handle for flushing
- + Raised height WC
- + White ergonomic toilet seat with lid
- + Close coupled cistern with screw down lid
- + White grab rails
- + White fold up grab rail
- + High visibility blue rails and toilet seat also available
- + Full flush 6 litres, reduced flush 4 litres

Product Codes:

Doc M Pack 3 (White) **23202**

Doc M Pack 3 (Blue) **23203**



Electrical Warranty



See product details for specific approvals

Please note: all items are available separately.



Pack 4: Standard Low Level Doc M Pack



White Fluted Grab Rail



Fold-Up White Grab Rail



Low Level Cistern



Padded Back Rest

PACK INCLUDES

- + 2 tap hole wall mounted wash basin
- + Monobloc spray mixer tap
- + Easy operational flush handle
- + Raised height WC
- + White ergonomic toilet seat
- + Low level cistern with screw down lid
- + Padded back rest
- + White grab rails
- + White fold up grab rail
- + High visibility blue rails, toilet seat and back rest also available
- + Full flush 6 litres, reduced flush 4 litres

Product Codes:

Doc M Pack 4 (White)	23204
Doc M Pack 4 (Blue)	23205



Electrical Warranty



See product details for specific approvals

Please note: all items are available separately.



DOC M WASHROOM PRODUCTS

Doc M Hand Dryer



Suitable for all applications, the hygienic 2.3kW automatic hand dryer comes complete with a heavy duty white ABS cover.

FEATURES

- + Strong ABS case
- + High output element for rapid drying
- + Installer adjustable hand proximity sensor
- + Timing protection 60 seconds auto shut off
- + Temperature cut off protection
- + Power supply 220-240V
- + Weight: 3kg
- + IP rating: Drip Proof IP x 1
- + Dimensions: W: 235mm, H: 270mm, D: 142mm



Electrical Warranty



Product Code:

Hand Dryer 23624-UK

Doc M Padded Back Rest



FEATURES

- + Aids side transfer
- + Available in grey, blue and white
- + Made from polyurethane foam for easy cleaning
- + Cushion thickness 60mm
- + Projection from wall: 270mm

Product Codes:

Padded Back Rest (Blue)	01190BU
Padded Back Rest (Grey)	01190GR
Padded Back Rest (White)	01190WH



Doc M Shelving



AKW's range of white polypropylene shelving is designed for use next to the W/C, wash basin or showering area.

FEATURES

- + Easily removed for cleaning
- + Two sizes available (Small: 215mm length, 185mm depth), (Large: 530mm length, 230mm depth)
- + Rounded edges for safety
- + Hole for water drainage
- + Small shelf next to the toilet is designed for placing a colostomy bag onto if required
- + Larger shelf next to washbasin is available to place any items on when entering the bathroom

Product Codes:

Small Shelf	23145
Large Shelf	23146

Doc M Swing Bin



This easy to operate swing bin is available in grey, with a blue lid for the visually impaired.

FEATURES

- + Wide opening
- + Durable – will not rust, chip or peel
- + Dent resistant
- + Swing top keeps waste out of sight
- + Dimensions: W310mm, H610mm, D160mm

Product Code:

Swing Bin	23148
-----------	-------



Doc M Lever Operated Liquid Soap Dispenser



The AKW lever operated soap dispenser has been designed for easy operation, by hand, closed fist or elbow. It is refillable by simply topping up the soap bottle using liquid soap.

FEATURES

- + Lever operated
- + Extended blue lever provides better colour contrast/visibility and easy to operate with either elbow or closed fist
- + Refillable
- + Manufactured from ABS plastic
- + Dimensions: W200mm, H260mm, D120mm

Product Code:

Lever Operated Soap Dispenser	23142
-------------------------------	-------

Doc M Toilet Tissue Dispenser



This easy to operate swing bin is available in white, with a blue lid for the visually impaired.

FEATURES

- + Easy installation
- + Refillable using tissue up to 110 x 110mm in size
- + 240mm stack capacity
- + Lockable
- + Manufactured from ABS plastic
- + Dimensions: W135mm, H290mm, D130mm

Product Code:

Toilet Tissue Dispenser	23138
-------------------------	-------



Doc M Paper Towel Dispenser



FEATURES

- + Easy installation
- + Uses standard size towels
- + Large capacity – up to 350mm stack
- + Accepts interleaved or C fold hand towels up to 255mm (W)
- + Lockable
- + Manufactured from ABS plastic
- + Dimensions: W285mm, H380mm, D110mm

Product Code:

Paper Towel Dispenser **23139**



Doc M Clothes Hook



Though AKW clothes hooks have been specially designed for use in AKW Doc M packs. Their practical design and easy installation makes them suitable for many other applications.

FEATURES

- + Finished in blue for high contrast
- + Easy to install with fixings supplied
- + Removable for cleaning

Product Code:

Clothes Hook **23144**

Doc M Mirror



Made from toughened glass, the AKW mirror is ideal for use in public bathrooms. It features an adhesive backing sheet for added safety.

FEATURES

- + High colour contrast blue border
- + Manufactured from toughened glass
- + Adhesive backing sheet
- + 4 pre drilled fixing holes
- + Dimensions: H1000mm x W400mm

Product Code:

Mirror **23147**

Doc M Emergency Alarm & Pull Cord



The AKW emergency audio alarm operates by a simple pull cord to allow users to raise an alarm from within a toilet or closed room. In standby mode the alarm shows a green 'power on' light. Once pulled, a flashing red 'alarm' light is triggered, along with an audio signal.

FEATURES

- + Easy to operate control panel with 2 LEDs: green for 'on', red for 'activated'
- + Reset switch
- + Long pull cord with two red bangles for grip
- + 12V DC Power supply, 90dbA
- + CE Certified
- + Can be connected to a 3A fused switched spur or plugged into a dedicated 3A fused, 13A plug and 230V AC supply socket
- + Designed to BS8300:2009 guidelines

Product Code:

Emergency Alarm & Pull Cord **23143**



Electrical Warranty

Mobility Ramps

From simple kerb stones to more complex flights of steps, we provide a wide range of solutions for all your access needs.

Please contact us for details or a survey of particular requirements.



FOLDING ACCESS RAMPS

Channel Folding Access Ramp



FEATURES

- + Length: 1830mm, Width: 292mm (Internal Track Width: 203mm)
- + Weight: 12kg per pair
- + Durable glass reinforced plastic
- + Can be easily packed away and stored
- + Smooth corners prevent damage to upholstery and vehicles
- + Distributed carrying capacity of 40 stone/240kg

Product Code:

Channel Folding Access Ramp

25060

Briefcase Folding Access Ramp



FEATURES

- + Length: 1370mm, Width: 840mm (Internal Track Width: 736mm)
- + Weight: 11kg
- + Durable glass reinforced plastic
- + Can be easily packed away and stored
- + Smooth corners prevent damage to upholstery and vehicles
- + Distributed carrying capacity of 40 stone/240kg

Product Code:

Briefcase Folding Access Ramp

25061

Scooter Folding Access Ramp

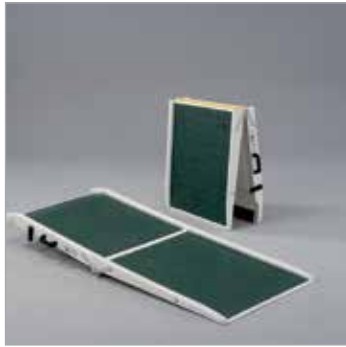

FEATURES

- + Length: 1830mm, Width: 710mm (Internal Track Width: 622mm)
- + Weight: 13kg
- + Durable glass reinforced plastic
- + Can be easily packed away and stored
- + Smooth corners prevent damage to upholstery and vehicles
- + Distributed carrying capacity of 40 stone/240kg

Product Code:

Scooter Folding Access Ramp **25062**

Standard Threshold Ramp



FEATURES

- + Length: 457mm, Width: 781mm (Internal Track Width: 730mm)
- + Weight: 4kg
- + Durable glass reinforced plastic
- + Smooth corners prevent damage to upholstery and vehicles
- + Distributed carrying capacity of 40 stone/240kg

Product Code:

Standard Threshold Ramp **25064**

THRESHOLD RAMPS

Folding Threshold Ramp



FEATURES

- + Length: 1200mm, Width: 660mm (Internal Track Width: 622mm)
- + Weight: 7kg
- + Durable glass reinforced plastic
- + Smooth corners prevent damage to upholstery and vehicles
- + Distributed carrying capacity of 40 stone/240kg

Product Code:

Folding Threshold Ramp **25066**

6" Threshold Ramp



FEATURES

- + Length: 914mm, Width: 820mm (Internal Track Width: 737mm)
- + Weight: 8kg
- + Durable glass reinforced plastic
- + Smooth corners prevent damage to upholstery and vehicles
- + Distributed carrying capacity of 40 stone/240kg

Product Code:

6" Threshold Ramp **25065**



Washroom Products

SANITARYWARE **262**

Toilets	263
Doc M Toilet Pans	264
Floor Mounted Toilet Pans	266
Wall Hung Toilet Pans	270
Geberit AquaClean	273
Toilet Accessories	275
Body Dryers	276
Wash Basins	277

BRASSWARE **282**

Wash Basin Taps	283
Taps (pair)	283
Mixer Taps	283
Brassware Accessories	285

SAFETY HEATING **286**

Towel Warmers	287
Underfloor Heating	288

LIGHTS & EXTRACTOR FANS **290**

Bathroom Lights	291
Extractor Fans	295



See our Doc M Washroom Product Range on page [251](#)

Sanitaryware

Our sanitaryware has been specially developed for users with reduced mobility.

Our products are strong, reliable, stylish and comfortable and with a wide range to choose from.



You may also need:

Grab Rails	Doc M Products
210 >	251 >

TOILETS

Doc M Close Coupled Toilet Pan



This raised height toilet pan has been specially designed for use in AKW Doc M packs.

FEATURES

- + Suitable for use with Close Coupled cistern, product code 23162, see page 265
- + Raised height
- + Large footprint
- + 650mm standard projection (750mm projection available to assist with side transfer)
- + Manufactured from White Vitreous China
- + 4 point fixing to floor supplied
- + Conforms to BS EN997
- + CE Certified
- + Height with toilet seat is 480mm, which complies to Doc M guidelines
- + Weight limited to 60 stone/400kg

Physical Dimensions (mm):

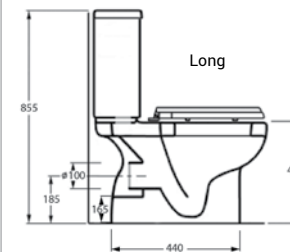
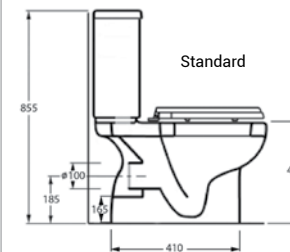
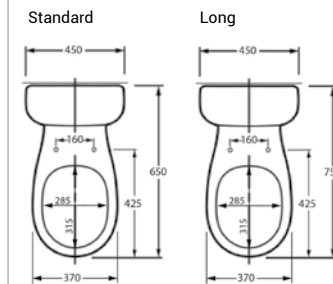

For use with Ergonomic Toilet Seat. See page 275

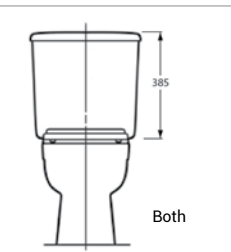

Doc M Raised Height Back-to-Wall Toilet Pan



Specially designed for use with the AKW low level cistern and padded back rest.

FEATURES

- + Specially designed for wheelchair users
- + Suitable for use with Low Level cistern product code 23162, see page 265
- + Raised height
- + Large footprint
- + Manufactured from White Vitreous China
- + Conforms to BS EN997
- + CE Certified
- + 4 point fixing to floor supplied
- + Height with toilet seat is 480mm, which complies to Doc M guidelines
- + Weight limited to 60 stone/400kg

Product Code: **23161**

Physical Dimensions (mm):

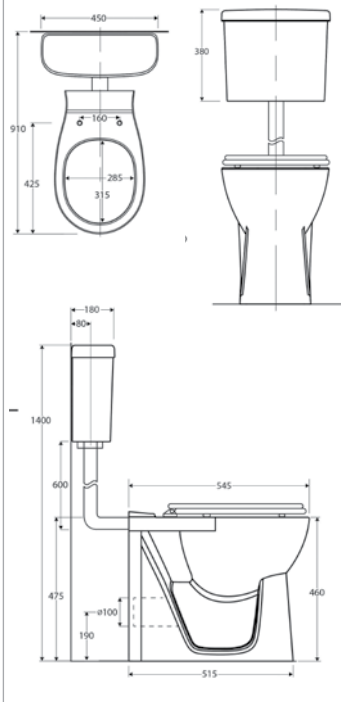

WRAS Approval: 1106062



i For use with Ergonomic Toilet Seat.
See page 275

Doc M Cistern, Flush Valve & Handle



AKW Doc M cistern been designed for use with the AKW toilet pan range.

FEATURES

- + Comes with a spatula dual flush handle, with complete flush mechanism and fill valve
- + Low level cistern or close coupled cistern available
- + Manufactured from White Vitreous China
- + Screw down lid for added safety and security
- + Dual Flush 6 & 4 litre for maximum water efficiency
- + WRAS approval to EN997 standards
- + Non handed, it fits either left or right
- + Low level comes with flush pipe (760x305mm)
- + Height: 385mm, Width: 450mm

Product Codes:

Low Level Cistern (Includes the flush pipe*) **23164**

Close Coupled Cistern **23163**



i This is a spare part and is supplied with 23164 and 23163

* Flush pipe packaged separately

Replacement Spatula Flush Handle & Mechanism Kit



WRAS Approval: 1105343



FEATURES

- + Compact spatula design handle with chrome finish
- + Easy to operate lever, can be flushed with minimal force by closed fist or elbow
- + Provides half flush option which can be controlled by the user for maximum water efficiency
- + Full/Half flush operation indicators
- + Clear and raised markings make it suitable for partially sighted users
- + Non handed, it fits either left or right
- + Handle is unique to AKW flush mechanism
- + Guaranteed for life
- + WRAS approved flush mechanism and fill valve

Product Code: **23165**

Livenza Standard Close Coupled Toilet Pan, Cistern & Seat



FEATURES

- + Suitable for use with Close Coupled cistern
- + Rounded edges and corners for safety
- + 3/6 litre flush for water efficiency
- + Chrome push button dual flush
- + Bottom inlet tank
- + Exposed outlet for easy fitting and maintenance
- + WRAS approved flush fittings included
- + Complies with BS EN 997 ensuring flush performance
- + Matching wrap over seat available
- + Lifetime guarantee against manufacturer's defects in ceramics
- + 10 year guarantee on flush fittings

Product Codes:

Standard Close Coupled Toilet Pan	23501
Cistern Tank for Close Coupled Toilet Pan	23502
Seat for Close Coupled Toilet Pan	23505

Physical Dimensions (mm):

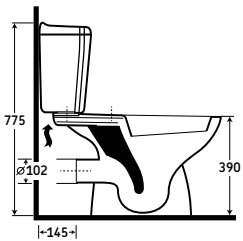
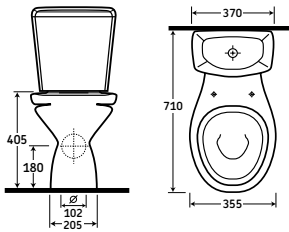

BS EN 997



Compact Comfort Height Close Coupled Toilet Pan, Cistern & Seat



FEATURES

- + Contemporary styling with fully in-line cistern tank
- + Comfort height (450mm without seat)
- + Soft close, quick release and top fix seat
- + 61.5mm projection
- + Concealed fixings
- + Includes WRAS approved cistern fittings (available separately if required)

Product Codes:

Compact Comfort Height Toilet Pan only	23640
Cistern Tank for Compact Toilet Pan only	23641
Soft Close Seat for Compact Toilet Pan only	23642

Kit:

Complete kit of Compact Comfort Height WC	23634
---	--------------

Physical Dimensions (mm):

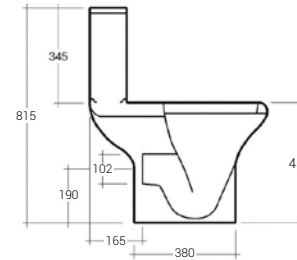
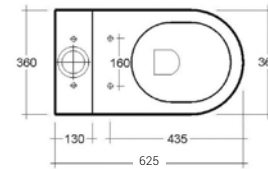

Compact Standard Height Close Coupled Toilet Pan, Cistern & Seat



FEATURES

- + Contemporary styling with fully in-line cistern tank
- + Standard height (405mm without seat)
- + Soft close, quick release and top fix seat
- + 615mm projection
- + Concealed fixings
- + Includes WRAS approved cistern fittings (available separately if required)

Product Codes:

Compact Standard Height Toilet Pan only	23639
Cistern Tank for Compact Toilet Pan only	23641
Soft Close Seat for Compact Toilet Pan only	23642

Kit:

Complete kit Compact Standard Height WC	23633
---	--------------

Physical Dimensions (mm):

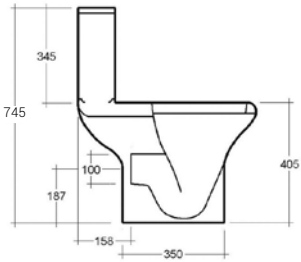
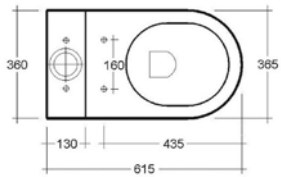

Compact Back-to-Wall Toilet Pan & Seat



FEATURES

- + Rounded design
- + Soft close, quick release and top fix seat
- + 510mm projection
- + Concealed fixings
- + Includes WRAS approved cistern fittings (available separately if required)
- + Suitable for use with the concealed Dudley cistern code 28179
- + Works with the Geberit Wall Hung System, see page 272

Product Codes:

Compact Back-to-Wall Toilet Pan	23643
Soft Close Seat for Compact Toilet Pan	23642

Physical Dimensions (mm):

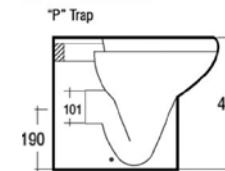
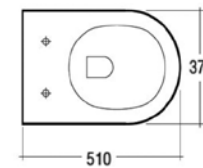

Livenza Standard Height Wall Hung Toilet Pan & Seat



FEATURES

- + Rounded edges and corners for safety
- + Standard 102mm diameter outlet for easy plumbing
- + Complies with BS EN 997 ensuring flush performance
- + Matching wrap over seat available
- + Compatible with standard wall hung frames
- + Market leading Geberit Wall Hung Fixing available
- + Lifetime guarantee against manufacturer's defects in ceramics
- + 10 year guarantee on flush fitting
- + Not compatible with ergonomic toilet seat
- + Weight limited to 15.7 stone

Product Codes:

Livenza Wall Hung Toilet Pan	23518
Seat for Livenza Wall Hung Toilet Pan	23519



i Can be used with Livenza Standard Close Coupled Cistern product code: 23502. **See page 266**

Physical Dimensions (mm):

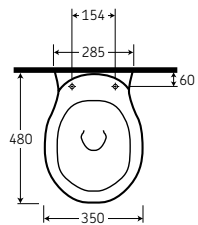
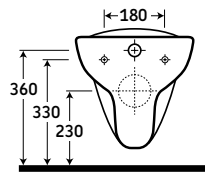
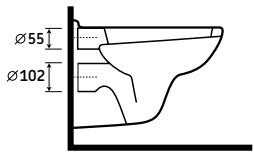

Toilet Plinth



FEATURES

- + White
- + Raises heights of existing toilet pans for easy access and side transfer
- + Top surface: 470 x 280mm for all sizes

Product Codes:

50mm Height Toilet Plinth	25042S
75mm Height Toilet Plinth	25044S
100mm Height Toilet Plinth	25043S

Physical Dimensions (mm):

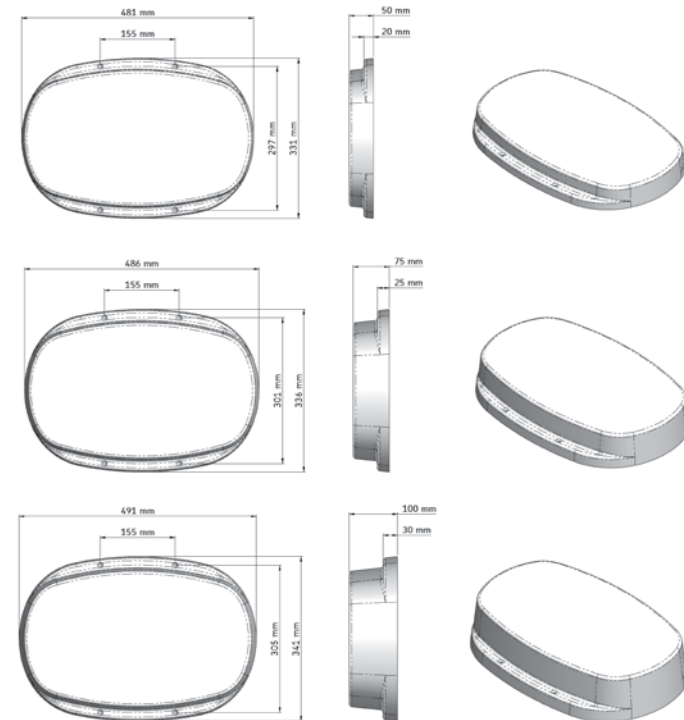

Geberit Kappa Duofix Wall Hung Frame & Cistern



FEATURES

- + Can be used in front of solid or drywall construction
- + Self-supporting frame with C profile 40/40mm
- + Geberit Kappa concealed cistern for tool free mounting and fully insulated against condensation
- + Frame height adjustable from 820-1020mm
- + Flush valve allows for 3/6 litre or 3/4.5 litre flush

Product Codes:

Geberit Duofix Wall Hung Frame & Cistern	23515
Geberit Flush Plate Chrome Kappa 20	23516
Geberit Flush Plate White Kappa 20	23517

Geberit AquaClean 8000plus Care Toilet



Elegantly designed, the Geberit AquaClean 8000plus Care incorporates a simple to use shower, dryer and odour extraction. Easy to operate and virtually touch-free, it provides you with an all-round cleaner, more comfortable and more hygienic experience. It will leave you feeling clean, fresh and improve your sense of well-being.

FEATURES

- + Extending spray arm will wash you with a gentle, oscillating or pulsating jet of warm water
- + The water temperature (along with other features) can be adjusted providing a pleasant experience, even for the most sensitive skin
- + The lady spray setting also provides advanced cleaning for feminine hygiene
- + Unpleasant odours will barely have time to circulate the room due to the efficient built in odour extraction that is activated as soon as you sit down
- + After washing, it will gently and quietly dry you with a flow of warm air. Drying is completed in seconds – leaving you feeling clean, fresh and confident
- + The spray nozzle is rinsed with fresh water before and after each use, ensuring spotless cleanliness at all times
- + Can be easily fitted, even in wet rooms

CE





Geberit AquaClean 8000plus Care Toilet (Technical Information)

Physical Dimensions (mm):

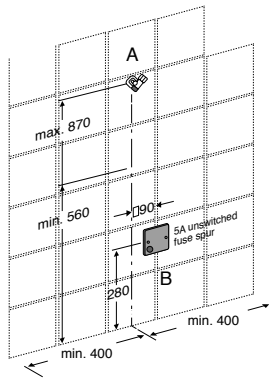
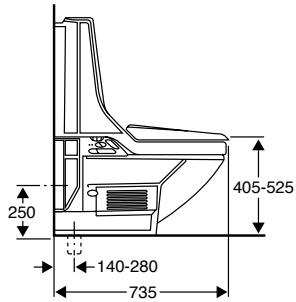
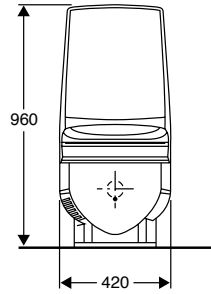

Colour	White
Nominal Voltage	230V AC
Mains Frequency	50-60Hz
Power Consumption	1000W
Power Consumption Standby (with Heating Element switched on)	1/9W
Protection Degree	IPX4
Length of Mains Connection Cable	70cm
Flow Rate (Anal Spray)	2.1-5.5 l/min
Flow Rate (Lady Spray)	1.4-3 l/min
Dryer Temperature Factory Setting	45°C
Dryer Temperature Range	20-45°C
Water Temperature Factory Setting	37°C
Water Temperature Range	10-39°C
Spray Time Factory Setting	20 Seconds
Number of Shower Pressure Settings (Shower Spray)	7
Flow Pressure Range (Mains Water)	1-10 Bar
Storage Water Heater Capacity	2.2l
Flush Volume Factory Setting	6 and 3l
Maximum Load of Strengthened Seat	150kg
Operating Temperature	10-40°C

Must be connected to a mains water supply

Product Code:

Geberit AquaClean 8000plus Care **23230**

Toilet Accessories

Ergonomic Toilet Seat



Ideal for any situation where side transfer or extra stability is required, AKW toilet seats are ergonomically designed for comfort, easy cleaning and added strength.

FEATURES

- + Compatible with all DOC M Pans, (not Livenza)
- + Strong metal hinges and lugs grip the inside of the pan for added strength
- + Contoured for maximum comfort
- + Available in white or blue for visually impaired users, and with or without lid
- + Strong metal, soft close hinges
- + Easy installation
- + Easy to clean
- + Made from Urea Formaldehyde
- + Width: 375mm, Front-to-back: 435mm
- + Weight limited to 47 stone/300kg

Product Codes:

White Ergonomic Toilet Seat (With Lid)	23122
White Ergonomic Toilet Seat (Without Lid)	23123
Blue Ergonomic Toilet Seat (With Lid)	23124
Blue Ergonomic Toilet Seat (Without Lid)	23125
Mid Grey Ergonomic Toilet Seat (With Lid)	23124MG
Mid Grey Ergonomic Toilet Seat (Without Lid)	23125MG
Spare Toilet Seat Lug	06-021-033



BODY DRYERS

Après™ Body Dryer



The Après™ Body Dryer is an all-over body dryer for the bathroom, shower room or wet room. Its gentle air jets dry the whole body with perfectly balanced heat, eliminating the use of towels. Ideal for infection control.

FEATURES & BENEFITS

- + 90% less energy compared to towel usage
- + More comfortable experience
- + Hygienically & environmentally friendly
- + Reduce steam / condensation / mildew
- + Dry even the hard to reach areas
- + Huge cost savings

PRODUCT SPECIFICATION

- + 2075mm high
- + 3 Year Guarantee
- + Average air outlet temperature: 70°F or 20°C (depending on ambient temperature)
- + Voltage: 220/240v
- + Amperage: 12.8amp
- + Nominal Output: 2.9 kilowatts
- + x2 Speed on/off air control switch can be mounted at any height (or on the floor)
- + Manufactured in white ABS plastic
- + British designed and manufactured

Product Code:

Après™ Body Dryer **23925**

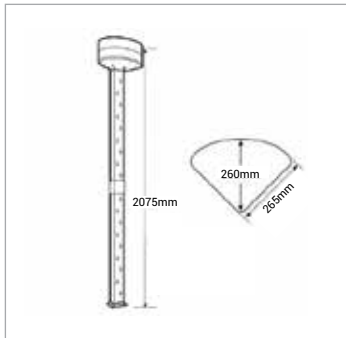

WASH BASINS

Doc M Finger Rinse 400mm Wash Basin



This compact 400mm wash basin is specifically designed for use with the AKW Doc M pack.

FEATURES

- + 2 tap hole complete with waste trap & fixings
- + Mixer tap (available separately) can be fitted left or right-handed
- + 400mm (w) x 340mm (d)
- + Additional bracket under washbasin for extra support
- + Supplied with a waste and trap
- + Non-handed (two tap hole basin, blanking plug supplied)
- + Easy installation
- + Volume capacity: 4 litres

Product Code:

Finger Rinse Wash Basin **23117**



i For compatible taps see TMV3 Thermostatic Mixer Tap code: 23116A. **See page 284**

Physical Dimensions (mm):

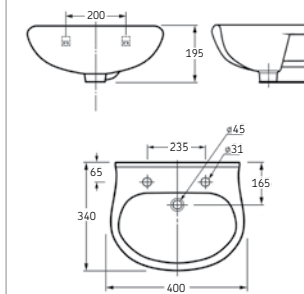

Standard Wash Basin



FEATURES

- + Two widths available: 450mm & 505mm
- + Depth: 395mm (450mm), 430mm (505mm)
- + Supplied with a shroud to cover waste as standard
- + Includes plastic waste trap
- + Non-handed – two tap hole basin, blanking plug supplied
- + Easy installation
- + Semi and full pedestal options available
- + Volume capacity: 5 litres (450mm), 6 litres (505mm)
- + Plug and chain supplied

Physical Dimensions (mm):

450mm Width:

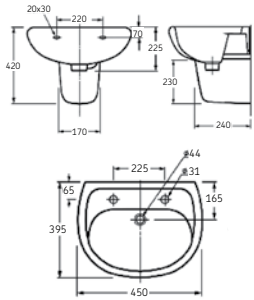

505mm Width:

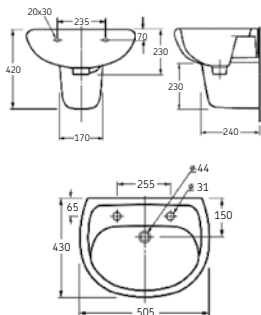

Product Codes:

450mm Wide Wash Basin (Semi Pedestal) **23126**

450mm Wide Wash Basin (Full Pedestal) **23126-FP**

505mm Wide Wash Basin (Semi Pedestal) **23127**

505mm Wide Wash Basin (Full Pedestal) **23127-FP**

Livenza Wash Basin



Semi Pedestal



Full Pedestal

FEATURES

- + Available in 3 widths: 450mm, 500mm & 550mm
- + Rounded edges and corners for safety
- + Single & double tap holes available on all sizes
- + Chrome overflow insert
- + No chain-stay to allow use of clicker waste
- + Chain-stay hole on 2 Tap Hole basins
- + Matching full or semi pedestal available
- + Waste, taps and pedestal supplied separately

Product Codes:

Basins:	A	B	C	D	E	Volume	Code:
450 Basin (1 tap hole)	450	365	165	140	220	2 litres	23507
450 Basin (2 tap holes)	450	365	165	140	220	2 litres	23512
500 Basin (1 tap hole)	500	395	185	155	280	2.5 litres	23503
500 Basin (2 tap holes)	500	395	185	155	280	2.5 litres	23513
550 Basin (1 tap hole)	550	430	205	170	280	4.5 litres	23508
550 Basin (2 tap holes)	550	430	205	170	280	4.5 litres	23514

Small Livenza Semi Pedestal **23504**
(suitable for 450mm & 500mm wash basins)

Large Livenza Semi Pedestal **23511**
(suitable for 550mm wash basins)

Full Livenza Pedestal **23510**

Chrome Plated Brass Waste with Plug **13-009-030**

Basin 1 and 1/4 inch 32mm Bottle Trap White **08-006-040**

Chrome Bottle Trap **08-006-038**



Physical Dimensions (mm):

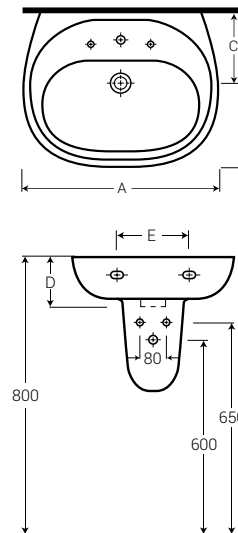

Compact Wash Basin



Semi Pedestal



Full Pedestal

FEATURES

- + Two widths available: 450mm & 550mm
- + Depth: 360mm (450mm), 410mm (550mm)
- + Contemporary rounded design
- + Chrome overflow insert
- + One and two tap hole options available
- + Semi and full pedestal options available
- + Concealed pedestal fixings

Product Codes:

Compact 450mm Wide Wash Basin (One Tap Hole)	23635
Compact 450mm Wide Wash Basin (Two Tap Holes)	23636
Compact 550mm Wide Wash Basin (One Tap Hole)	23631
Compact 550mm Wide Wash Basin (Two Tap Holes)	23630
Full Pedestal for Compact Wash Basin	23632
Semi Pedestal for Compact Wash Basin	23638
Chrome plated brass waste with plug	13-009-030
Clicker Waste	23385

Physical Dimensions (mm):

450mm Width:

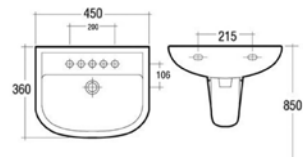

550mm Width:

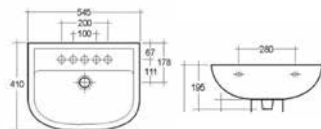

Ergonomic Concave Doc M Wash Basin



Semi Pedestal



Full Pedestal

FEATURES

- + Ergonomically designed for wheelchair, walking frame or perching stool users
- + Concaved front, for closer access to basin and taps
- + 600mm (w) x 420mm (d)
- + Supplied with plug and chain
- + Includes waste trap and shroud as standard
- + Semi and full pedestal options available
- + Volume capacity: 3 litres
- + Capacity: 550mm wide sink is 6L and the 450mm wide sink is 4.5L

Product Codes:

Ergonomic Concave Doc M Wash Basin (with Semi Pedestal)	23115
Ergonomic Concave Doc M Wash Basin (with Full Pedestal)	23115-FP



Physical Dimensions (mm):

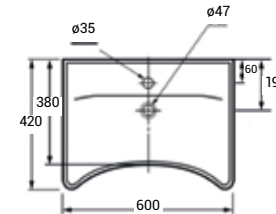

Brassware

AKW's brassware is easy to install, easy to use and comes with a lifetime guarantee, giving you timeless style and total piece of mind.



WASH BASIN TAPS

Lever Wash Basin Taps (Pair)



FEATURES

- + Stylish chrome finish
- + The 50mm lever design provides a smooth and controlled 90° turn operation (easy to operate with a hand or an arm, for users with limited dexterity)
- + Easy and quick installation
- + Coloured temperature indicator ring on taps
- + Minimum working pressure 0.2 bar

Product Code:

Lever Wash Basin Taps (Pair)

23196CH

AKW Denova® Wash Basin Taps (Pair)



FEATURES

- + 1/2" quarter turn
- + 5l/m flow limiter
- + Colour temperature indicator on handles

Product Code:

AKW Denova® Wash Basin Taps (Pair)

23189

Monobloc Spray Wash Basin Mixer Tap



FEATURES

- + For use with one or two tap hole wash basins
- + Polished chrome finish
- + Easy to install
- + User friendly long handle (lever 70mm)
- + Flexible hose

Product Code:

Monobloc Spray Wash Basin Mixer Tap

23118

TMV3 Thermostatic Wash Basin Mixer Tap



The TMV3 thermostatic mixer tap has an extended lever for easy operation using a closed fist or elbow.

FEATURES

- + TMV3 approved to prevent scalding
- + Integrated mixer valve for improved hygiene
- + Polished chrome finish
- + Lever 80mm

Product Code: 23116A



AKW Denova® Mono Wash Basin Mixer Tap



FEATURES

- + 35mm eco cartridge
- + Flexible hose
- + Chrome plated brass clicker waste
- + 5 l/m flow limiter

Product Code: 23316



AKW Denova® Mono Mini Wash Basin Mixer Tap

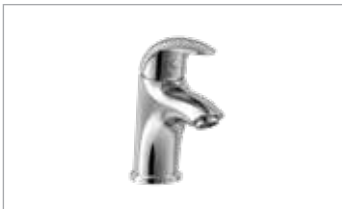

FEATURES

- + 28mm ceramic cartridge
- + Flexible hose
- + Chrome plated brass clicker waste
- + 5 l/m flow limiter

Product Code: 23317

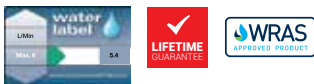

BLENDING VALVES

TMV2 & TMV3 Thermostatic 15mm & 22mm Blending Valves



Where vulnerable users are present, our range of thermostatic blending valves deliver safe, blended hot water to taps, showers, bidets and other water outlets, making it suitable for use in care and domestic environments.

FEATURES

- + 15 or 22mm blending valve
- + Easy to install
- + Integral check valves and strainers
- + Building regulations Part G compliant
- + Highly resistant to scaling
- + Tamper resistant head
- + 12 month warranty against manufacturing defects
- + TMV2 & TMV3 Approved
- + WRAS Approved

Product Codes:

15mm Thermostatic Blending Valve	23382
22mm Thermostatic Blending Valve	23383

NHS estates: D08 & BS7942:2000
BS EN1111 & BS EN1287:1999



Against manufacturing defects

Safety Heating

With external temperatures not exceeding 43°C, our towel warmers satisfy NHS Safe Surface Temperature Guidelines. Suitable for domestic use as well as in care or nursing homes and commercial buildings, they are easy to install, clean and use.



TOWEL WARMERS

Low Surface Temperature Towel Warmer



Keep towels warm and skin safe with an addition to the room that's a pleasure to look at and safe to touch.

FEATURES

- + Luxury chrome or white finish
- + Electric LST fixed heat element
- + Modern design
- + Straight or curved models available
- + Various sizes available
- + Can be used with a timer
- + Easy and quick to install
- + Low maintenance costs
- + IP66 rated – can be installed in zones 1 & 2*



2 year warranty on element

Radiator Product:	Width:	Height:	BTU/hr:	Wattage (W):	Code:
LST Straight Chrome Multirail Towel Warmer	300mm	800mm	1109	325	23426
LST Straight White Multirail Towel Warmer	300mm	800mm	1109	325	23427
LST Straight Chrome Multirail Towel Warmer	500mm	800mm	1434	420	23428
LST Straight White Multirail Towel Warmer	500mm	800mm	1434	420	23429
LST Straight Chrome Multirail Towel Warmer	300mm	1200mm	1672	490	23430
LST Straight White Multirail Towel Warmer	300mm	1200mm	1672	490	23431
LST Straight Chrome Multirail Towel Warmer	500mm	1200mm	2048	600	23432
LST Straight White Multirail Towel Warmer	500mm	1200mm	2048	600	23433
LST Curved Chrome Multirail Towel Warmer	500mm	800mm	1434	420	23434
LST Curved White Multirail Towel Warmer	500mm	800mm	1434	420	23435
LST Curved Chrome Multirail Towel Warmer	500mm	1200mm	2048	600	23436
LST Curved White Multirail Towel Warmer	500mm	1200mm	2048	600	23437

*Must be fitted in accordance with IEE Wiring Regulations.

UNDERFLOOR HEATING

Electric Underfloor Heating



2 year warranty on thermostat sensor

With its programmable thermostatic controller, it warms up floors quickly, helping keep them drier, safer and more comfortable to walk on.

FEATURES

- + Keeps floors dry and warm for comfort and safety
- + Programmable thermostatic controller
- + Free multi-meter to check installation at every stage
- + Economic to use
- + Quick to warm up
- + Manual override
- + 15 trimmable sizes
- + 4 metre power cable

Product Codes:

1m ² Underfloor Heating Kit (150W)	23438
1.5m ² Underfloor Heating Kit (225W)	23439
2m ² Underfloor Heating Kit (300W)	23440
2.5m ² Underfloor Heating Kit (375W)	23441
3m ² Underfloor Heating Kit (450W)	23442
3.5m ² Underfloor Heating Kit (525W)	23443
4m ² Underfloor Heating Kit (600W)	23444
4.5m ² Underfloor Heating Kit (675W)	23445
5m ² Underfloor Heating Kit (750W)	23446
6m ² Underfloor Heating Kit (900W)	23447
7m ² Underfloor Heating Kit (1050W)	23448
8m ² Underfloor Heating Kit (1200W)	23449
9m ² Underfloor Heating Kit (1350W)	23450
10m ² Underfloor Heating Kit (1500W)	23451
12m ² Underfloor Heating Kit (1800W)	23452



Lights & Extractor Fans

Our extractor fans and lights have been designed specifically for extra safety, for use in bathrooms and exceeding Building Regulation Requirements.



Download your copy of Lighting Guide for Accessible Bathrooms: www.akw-ltd.co.uk/akw-guides



BATHROOM LIGHTS

LED Bathroom Light



On all AKW electrical items



FEATURES

- + IP65 LED surface mounted light fitting (18 Watt)
- + Life length: 50,000 hours
- + Diameter: 290mm, Depth: 95mm
- + Class II – must be earthed
- + Voltage supply: 230V

Product Code:

30080

LED Bathroom Light – Dimming Sensor Function



LED light with adjustable movement and dimming sensor functionality, to ensure the light is only in use when the room is being occupied.

FEATURES

- + IP65 LED surface mounted light fitting (18 Watt)
- + Movement Sensor
- + Dimming and shut off sensor
- + Adjustable daylight sensor
- + Adjustable stand by time for dim function.
- + 3 Settings for stand by time and dim function

Product Codes:

LED Light - Dimming Sensor Function

30081

Related Product codes

LED Light – Dimming & Emergency Function **30082**



Excludes Light Bulb



LED Bathroom Light – Dimming Sensor and Emergency Function



LED light with adjustable movement and dimming sensor functionality, with the additional feature of an emergency backup ensure the light keeps working in the event of a power shortage, so users are not left in the dark.

FEATURES

- + Emergency Function
- + Movement Sensor
- + Dimming and shut off sensor
- + Adjustable daylight sensor
- + Adjustable stand by time for dim function.
- + 3 Settings for stand by time and dim function.

Product Codes:

LED Light – Dimming and
Emergency Function **30082**

Related Product codes

LED Light – Dimming Sensor Function **30081**



Excludes
Light Bulb



Task Focused LED Light



LED spotlight with a narrow beam to focus lighting on tasks being operated.

FEATURES

- + 30-degree narrow beam
- + 3000k warm white light
- + LED Long life
- + IP65 Rating
- + Supplied with a driver to convert higher voltage AC current into low voltage DC current required for LED lighting

Product Codes:

Task Focused LED Lights **30086**

Task Focused Lighting Kit **30088**

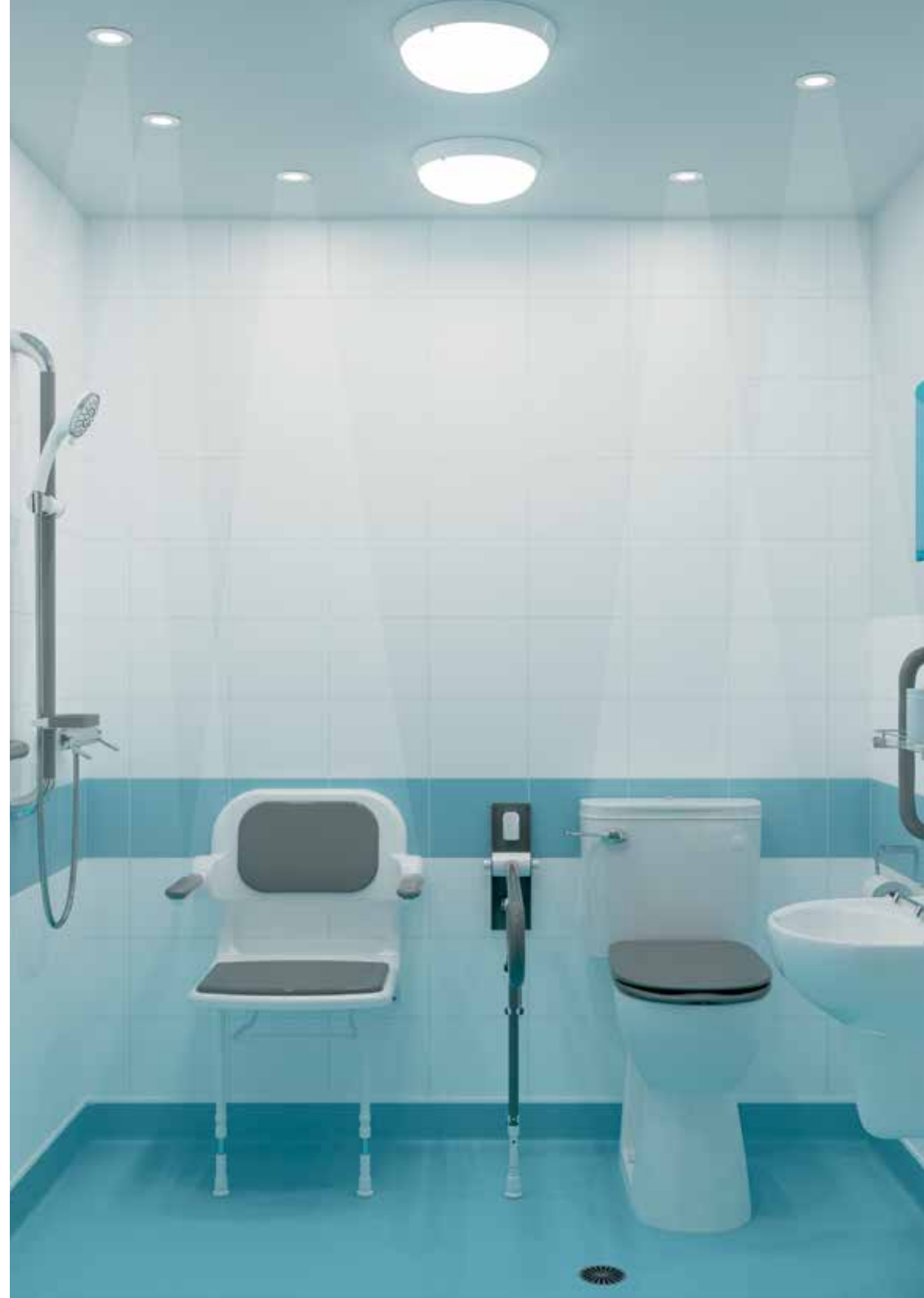

Task Focused Lighting Kit



The importance of good lighting cannot be underestimated and good lighting can mean different things to different people, depending on a person's specific health condition. Therefore, we have put together a Task Focused Lighting Kit to ensure sufficient light levels in the areas where specific tasks are undertaken promotes a person's longterm independence. Our recommended kit includes:

- + 5 x Task Focused 8W LED Lights
- + 2 x Standard 18W LED Lights
- + 1 x Pull Cord Switch

FEATURES

- + 30-degree narrow beam
- + 3000k warm white light
- + LED Long life
- + IP65 Rating
- + Supplied with a driver to convert higher voltage AC current into low voltage DC current required for LED lightin.

Product Codes:

LED Basic Light – 18W	30080
Task Focused LED Lights	30086
Pull Cord Switch	30087
Task Focussed Lighting Kit (2 x LED Basic Lights, 5 x Task Focused LEDs, 1 x Pull Cord)	30088



Excludes Light Bulb

EXTRACTOR FANS

AKW100 Series Low Voltage Bathroom Extractor Fan



FEATURES

- + An extra low 12VAC SELV voltage and thermal fuse give you added safety at all times
- + Can be wall or ceiling mounted
- + Made from lightweight ABS thermoplastic for long-life and easy cleaning
- + IP27 rating
- + Humidistat and adjustable overrun timer options
- + 100mm ducting diameter for safe and efficient extraction of moisture (in line with industry standards)
- + Slim plastic casing for easy and discreet fitting
- + Can be wired directly into bathroom light circuit
- + Designed to exceed Building Regulation (Document F) requirements

Product Codes:

Extractor Fan with Pull Cord	23152
Extractor Fan with Pull Cord & LED Light Kit	23211LED
Extractor Fan with Timer	23154
Extractor Fan with Timer & LED Light Kit	23212LED
Extractor Fan with Humidistat	23156
Extractor Fan with Humidistat & LED Light Kit	23213LED

Bathroom Furniture



FURNITURE	298
Basin Units	299
WC Units	300
Base Units	302
Countertops	303
Integrated Sanitaryware	304
Accessories	305
Handles	305
Optional Dual Flush Plate	305
Plinths/Infill Panels	305



Furniture

AKW's simple range of fitted bathroom furniture is both stylish and practical.

Fitted furniture is great for providing plenty of storage and hiding unsightly pipework, whilst vanity furniture gives you the flexibility to add units together or position them separately depending on your style of bathroom.



BASIN UNITS

Colour Options:



White Gloss

Driftwood

Sorano Oak

For matching **counter tops** see page 303

Basin Units



FEATURES

- + Two widths available: 500mm or 600mm
- + Height: 820mm, Depth: 350mm
- + Includes cabinet legs

Product Codes:

500mm White Gloss Basin Unit	28150WHT
600mm White Gloss Basin Unit	28151WHT
500mm Sorano Oak Basin Unit	28150OAK
600mm Sorano Oak Basin Unit	28151OAK
500mm Driftwood Basin Unit	28150DFT
600mm Driftwood Basin Unit	28151DFT

Handles, Plinths and Infill Panels are available for purchase separately. See [page 305](#)

Slimline Basin Units



FEATURES

- + Two widths available: 500mm or 600mm
- + Height: 820mm, Depth: 270mm
- + Includes cabinet legs

Product Codes:

500mm White Gloss Slimline Basin Unit	28154WHT
600mm White Gloss Slimline Basin Unit	28155WHT
500mm Sorano Oak Slimline Basin Unit	28154OAK
600mm Sorano Oak Slimline Basin Unit	28155OAK
500mm Driftwood Slimline Basin Unit	28154DFT
600mm Driftwood Slimline Basin Unit	28155DFT

Handles, Plinths and Infill Panels are available for purchase separately. See [page 305](#)

WC UNITS

Colour Options:



White Gloss Driftwood Sorano Oak

For matching counter tops see page 303

WC Units



FEATURES

- + Height: 820mm, Depth: 350mm
- + Two widths available: 500mm or 600mm
- + Includes cistern and a recessed flush button
- + An optional dual flush button is available separately. See page 305

Product Codes:

500mm White Gloss WC Unit	28152WHT
600mm White Gloss WC Unit	28153WHT
500mm Sorano Oak WC Unit	28152OAK
600mm Sorano Oak WC Unit	28153OAK
500mm Driftwood WC Unit	28152DFT
600mm Driftwood WC Unit	28153DFT

i Pan sold separately see page 269

Slimline WC Units



FEATURES

- + Height: 820mm, Depth: 270mm
- + Two widths available: 500mm or 600mm
- + Includes cistern and a recessed flush button
- + An optional dual flush button is available separately. See page 305

Product Codes:

500mm White Gloss SL WC Unit	28156WHT
600mm White Gloss SL WC Unit	28157WHT
500mm Sorano Oak SL WC Unit	28156OAK
600mm Sorano Oak SL WC Unit	28157OAK
500mm Driftwood SL WC Unit	28156DFT
600mm Driftwood SL WC Unit	28157DFT

i Pan sold separately see page 269

WC Units for Raised Height Pan



i Pan sold separately see page 269

FEATURES

- + Height: 820mm, Depth: 350mm
- + Two widths available: 500mm or 600mm
- + Includes cistern and a recessed flush button
- + Suitable for raised height toilet pans
- + An optional dual flush button is available separately. See page 305

Product Codes:

500mm White Gloss WC Unit	28193WHT
600mm White Gloss WC Unit	28194WHT
500mm Sorano Oak WC Unit	28193OAK
600mm Sorano Oak WC Unit	28194OAK
500mm Driftwood WC Unit	28193DFT
600mm Driftwood WC Unit	28194DFT

Slimline WC Units for Raised Height Pan



i Pan sold separately see page 269

FEATURES

- + Height: 820mm, Depth: 270mm
- + Two widths available: 500mm or 600mm
- + Includes cistern and a recessed flush button
- + Suitable for raised height toilet pans
- + An optional dual flush button is available separately. See page 305

Product Codes:

500mm White Gloss SL WC Unit	28195WHT
600mm White Gloss SL WC Unit	28196WHT
500mm Sorano Oak SL WC Unit	28195OAK
600mm Sorano Oak SL WC Unit	28196OAK
500mm Driftwood SL WC Unit	28195DFT
600mm Driftwood SL WC Unit	28196DFT

BASE UNITS

Colour Options:



White Gloss Driftwood Sorano Oak

For matching **counter tops** see **page 303**

Extra base units for storage and counter space. Floor mounted and made to order. Available in Slimline and with Full Door or Three Drawer options.

Full Door Base Units

FEATURES

- + Width: 400mm, Height: 820mm, Depth: 350mm

Product Codes:

White Gloss Full Door Unit	28138WHT
Sorano Oak Full Door Unit	28138OAK
Driftwood Full Door Unit	28138DFT

Full Door Slimline Base Units

FEATURES

- + Width: 400mm, Height: 820mm, Depth: 270mm

Product Codes:

Slimline White Gloss Full Door Unit	28184WHT
Slimline Sorano Oak Full Door Unit	28184OAK
Slimline Driftwood Full Door Unit	28184DFT

Three Drawer Base Units

FEATURES

- + Width: 400mm, Height: 820mm, Depth: 350mm
- + 3 handles are required, sold separately. **See page 305**

Product Codes:

White Gloss Full Door Unit	28188WHT
Sorano Oak Full Door Unit	28188OAK
Driftwood Full Door Unit	28188DFT

COUNTERTOPS

Colour Options:



White Gloss Everest Driftwood Alhambra Gloss

Countertops



FEATURES

- + Width: 1500mm, Height: 28mm, Depth: 365mm

Product Codes:

White Gloss Countertop	28131WHT
Everest Countertop	28131BLK
Driftwood Countertop	28131DFT
Alhambra Gloss Countertop	28131OAK

Slimline Countertops



FEATURES

- + Width: 1500mm, Height: 28mm, Depth: 290mm

Product Codes:

White Gloss Countertop	28132WHT
Everest Countertop	28132BLK
Driftwood Countertop	28132DFT
Alhambra Gloss Countertop	28132OAK

INTEGRATED SANITARYWARE

Semi-Recessed Basin



450mm basins are suitable for 500mm units and
550mm basins are suitable for 600mm units

FEATURES

- + Suitable for use with standard countertops
- + One tap hole or two tap holes
- + Taps are not included. For taps see page 283

Product Codes:

450mm Basin RH (1 tap hole)	28127RH
450mm Basin LH (1 tap hole)	28127LH
450mm Basin (2 tap holes)	28130
550mm Basin (1 central tap hole)	28145
550mm Basin (2 tap holes)	28146

Back-to-wall Toilet Pan



FEATURES

- + Domestic height (390mm)

Product Codes:

Back-to-Wall Toilet Pan	23643
Soft-Close Toilet Seat with Lid	23642

Raised Height Toilet Pan



FEATURES

- + Raised height (450mm)

Product Codes:

Raised Height Toilet Pan	23161
White Ergonomic Toilet Seat with Lid	23122
Blue Ergonomic Toilet Seat with Lid	23124

Bathroom Furniture Accessories

Traditional Knob Handle



Product Code:

Single Traditional Knob Handle **28136**

- i** 2 handles are required for basin unit,
3 handles for 3 drawer unit

D Handles



Product Code:

Single D Handle (Sold as singles) **28139**

- i** 2 handles are required for basin unit,
3 handles for 3 drawer unit

Optional Dual Flush Plate



FEATURES

- + Optional replacement for Recessed Flush Button

Product Code:

Palm-Push Dual Flush Plate **28180**

Plinths/Infill Panels

FEATURES

- + Width: 1500mm, Height: 300mm, Depth: 18mm

Product Codes:

White Gloss Plinth/Infill Panel	28118WHT
Sorano Oak Plinth/Infill Panel	28118OAK
Driftwood Plinth/Infill Panel	28118DFT

- i** x 1 required for basin unit

Plumbing Fittings



Compression Fittings	309
End Feed	310
Flexi Hoses	312
Isolating Valves	313
Push Fit	314
Solvent Weld	317



Plumbing Fittings

AKW's range of plumbing and pipe fittings contain the essential items needed to support an installation, available in convenient pack sizes that allow you to just order the items you need.

Pipe fittings connect pipework together and change the direction of waterflow. AKW offer both traditional metal pipe fittings such as compression and copper, alongside more modern plastic push fit. Alongside this there are flexi-hoses for the connection of taps and isolation valves for controlling the flow of water.

AKW also offer a selection of Solvent Weld wastepipe plumbing fittings, that connect appliances to the liquid waste network of the building.



COMPRESSION FITTINGS



Compression Fittings are used to couple together pipes or to connect a pipe to a fixture or valve. There are three elements to a compression fitting: a nut, ring and seat. These work together to give a watertight connection. This simple mechanism makes it quick and easy for installers to connect or disconnect fittings.



15mm Compression Straight Couplings x 5

Product Code: 30016



15mm Compression Elbows x 5

Product Code: 30017



15mm Compression Equal Tees x 5

Product Code: 30018



15mm Compression End Stops x 5

Product Code: 30019



22mm - 15mm Compression Reducers x 5

Product Code: 30020



15mm Olives x 25

Product Code: 30025



22mm Compression End Stop x 5

Product Code: 30024

END FEED



End Feed fittings are used for connecting copper piping and provide a robust yet, economical option. Copper piping and joins are suitable in plumbing applications for both hot and cold water supplies. Connections are made by applying flux and a heat source to reach a suitable temperature, then adding solder around the joint to seal



15mm End Feed Street Elbows x 5

Product Code: 30003



15mm End Feed Equal Tees x 5

Product Code: 30004



15mm x 3m Copper Pipes

Product Code: 30005



15mm x Copper Stop Ends x 5

Product Code: 30101



22mm - 15mm End Feed Reducers x 5

Product Code: 30007



15mm Pipe Clips x 100

Product Code: 30013



15mm End Feed Straight Couplings x 5

Product Code: 30001



15mm End Feed Elbows x 5

Product Code: 30002



Pipe Clip Spacers x 100

Product Code: 30015

FLEXI HOSES



Flexi hoses are used to allow you to connect taps to the water supply and are an excellent option when space is limited. They feature compression fittings on either end of the hose to make it quick and easy for installers to connect or disconnect the fitting.



FH 15mm Compression to 1/2" BSP 300mm LG x 2

Product Code: 30048



FH 15mm Compression to 3/4" BSP 300mm LG x 2

Product Code: 30049



FH with Valve 15mm Comp to 1/2" BSP 300mm LG x 2

Product Code: 30090



FH 1/2 BSP to 1/2" BSP 300mm LG x 2

Product Code: 30051

ISOLATING VALVES



Isolating Valves control the flow of water from the mains to a water service pipe. This is an ideal solution for fixing some problems, such as a dripping tap, without the need to shut the water off at the mains. The valve is easy for installers to operate, as it can be opened and closed using a flat head screwdriver.



15mm Compression Full Bore Isolating Valves x 5

Product Code: 30054



15mm Compression Isolating Valves x 5

Product Code: 30053



15mm Compression Isolating Elbow x 5

Product Code: 30089

PUSH FIT



Push Fit plumbing fittings are quick and easy for installers to connect without the need for any specialist tools or sealant. Push Fit works by inserting the pipe into the fitting and then sealing a watertight connection by twisting the rotating sealing cap. Unlike with some other fittings, Push Fit connections can be disassembled and reused by twisting the sealing cap on the fitting. Our Push Fit range comes from industry leading brands to ensure quality and reliability.



15mm Push Fit Straight Couplings x 10

Product Code: 30056



15mm Push Fit Elbows x 10

Product Code: 30057



15mm Push Fit Equal Tees x 10

Product Code: 30058



22mm – 15mm Push Fit Reducers x 5

Product Code: 30059



15mm Push Fit Pipe Inserts x 10

Product Code: 30060



15mm Push Fit End Stops x 10

Product Code: 30061



25m Roll of 15mm Push Fit Pipe

Product Code: 30062



22mm Push Fit Straight Couplings x 5

Product Code: 30063



22mm Push Fit Elbows x 5

Product Code: 30064



22mm Push Fit Equal Tees x 3

Product Code: 30065



22mm Push Fit Pipe
Inserts x 10

Product Code: 30066



22mm Push Fit
End Stops x 5

Product Code: 30067



25m Roll of 22mm
Push Fit Pipe

Product Code: 30068



15mm Collet
Locking Clip x 10

Product Code: 01-019-025X5



22mm Collet
Locking Clip x 10

Product Code: 01-019-026X5

SOLVENT WELD



Solvent Weld pipes and fittings use solvent cement to create a permanent joint. Solvent cement is brushed to the inside of the fittings and the outside of the pipe, then the pipe is inserted into the fitting and twisted to ensure full coverage. Solvent Weld waste pipe and fittings are used to connect appliances to the waste network in the building that carry it away. Our Solvent Weld range comes from Floplast, a brand with a strong reputation for quality and reliability.



250ml tin of Solvent

Product Code: 30037



32mm Pipe Saddle x 5

Product Code: 30036



32mm Solvent Weld
Elbows x 5

Product Code: 30028



32mm Solvent Weld
Obtuse Elbows x 5

Product Code: 30030



32mm Solvent Weld
Obtuse Street Elbows x 5

Product Code: 30032



32mm Solvent Weld
Straight Couplings x 5

Product Code: 30027



32mm Solvent Weld Street Elbows x 5

Product Code: 30031



32mm Solvent Weld Swept Elbows x 5

Product Code: 30029



32mm Solvent Weld Swept Equal Tees x 5

Product Code: 30033



40mm Solvent Weld Straight Couplings x 5

Product Code: 30038



40mm Solvent Weld Street Elbows x 5

Product Code: 30042



40mm Solvent Weld Swept Elbows x 5

Product Code: 30040



32mm x 3m Solvent Weld Pipes

Product Code: 30035



40mm - 32mm Solvent Weld Reducers x 5

Product Code: 30034



40mm Pipe Saddle x 5

Product Code: 30046



40mm Solvent Weld Swept Equal Tees x 5

Product Code: 30044



40mm x 3m Solvent Weld Pipe

Product Code: 30045



Flexible Pan Connector

Product Code: 30052



40mm Solvent Weld Elbows x 5

Product Code: 30039



40mm Solvent Weld Obtuse Elbows x 5

Product Code: 30041



40mm Solvent Weld Obtuse Street Elbows x 5

Product Code: 30043



110mm Soil and Vent Pipe Strap with 40mm Boss

Product Code: 30047





Kitchens

ACTIVMOTION® 322

ActivMotion® Worktops	323
ActivMotion® Cupboards	324

INDEPENDENCE KITCHEN 326

Unit Options	327
Tall Units	327
Wall Units	330
Base Units	334
Bridging Units	339
Trolley Units	341
Corner Carousel Units	342
Door Colour Options	343

LIBERTY KITCHEN 344

Unit Options	345
Tall Units	345
Wall Units	346
Base Units	347
Accessories	349
Panels, Plinths & Fixtures	349
Door Colour Options	353

KITCHEN OPTIONS 354

Door Handles	355
Worktops	357
Appliances	358
Ovens	358
Hobs	360
Extractor Hoods	362
Sinks	364
Taps	367



ActivMotion®

The ActivMotion® Rise and Fall range from AKW is at the centre of most inclusive kitchens, whether it's an adaptation or a fully accessible kitchen.

The conveniently placed controls allow you to adjust worktops to exactly the right height for you, and the shelves of your wall units can magically descend to within reach at the simple push of a button.



ACTIVMOTION® WORKTOPS

ActivMotion® Worktop/Table



ActivMotion® Worktops come in a wide range of configurations and sizes to suit every user and every room. They can also be used to support sinks and hobs, making them ideal for wheelchair users (giving easy access underneath) and multi user areas.

FEATURES

- + Operated at the touch of a button
- + Ideal for rehab units
- + Controls can be positioned where they are most accessible for the user
- + Made-to-measure. Can be any size from 500-3000mm (L-Shaped up to 3000 x 3000mm)
- + Wall mounted and free standing options
- + Modesty panels available for most sizes of wall mounted units
- + Height adjustment from 690-1100mm
- + Optional safety strip available
- + Lifting speed of 30mm/s

ACTIVMOTION® CUPBOARDS

ActivMotion® Cupboard



With accessible storage space at a premium in an accessible kitchen, the ActivMotion® rise & fall cupboard is the perfect solution. The simple controls make it easy to activate the smooth and quiet motion to lower the cupboard to an accessible height.

FEATURES

- + Offers additional accessible storage space for users with restricted reach or wheelchair users
- + Ideal for compact kitchens where floor space is limited
- + Collision detection on both upward and downward movements
- + Pre-assembled in carcass
- + Available widths: 500mm or 600mm
- + Can be operated with the door open or closed
- + Maximum contents weight per shelf is 7kg
- + Total maximum contents weight is 15kg



Independence Kitchen

An Independence Kitchen is made to measure for your individual needs. An enhanced range of colours, doors and worktops, along with colour matched fascias, carcasses and other bespoke options, puts you in control of your ideal kitchen.



L/R in the product code denotes whether the product is Left or Right handed.

INDEPENDENCE TALL UNIT OPTIONS

Larder/Broom Unit

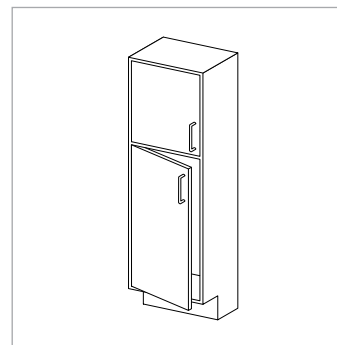

FEATURES

- + Made-to-measure tall unit (height variable)
- + Available in four widths: 300, 400, 500 or 600mm

Product Codes:

300mm Larder/Broom Unit	LB30L/R
400mm Larder/Broom Unit	LB40L/R
500mm Larder/Broom Unit	LB50L/R
600mm Larder/Broom Unit	LB60L/R

Larder Unit (3 Drawers)

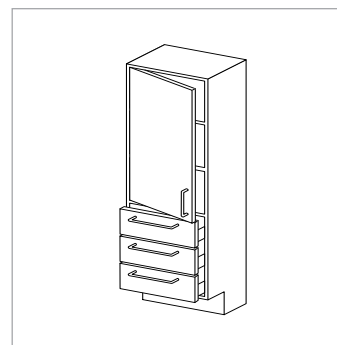

FEATURES

- + Made-to-measure tall unit (height variable)
- + Available in four widths: 300, 400, 500 or 600mm

Product Codes:

300mm Larder/Broom Unit	LAR30L/R
400mm Larder/Broom Unit	LAR40L/R
500mm Larder/Broom Unit	LAR50L/R
600mm Larder/Broom Unit	LAR60L/R

Larder Unit (with Full Height Basket Set)

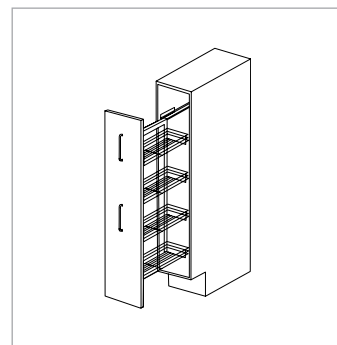

FEATURES

- + Made-to-measure tall unit (height variable)
- + Available with slide or swing-out baskets

Product Codes:

300mm Larder Unit (Slide-Out Baskets)	LB30+FB
400mm Larder Unit (Slide-Out Baskets)	LB40+FB
500mm Larder Unit (Swing-Out Baskets)	LB50+FB
600mm Larder Unit (Swing-Out Baskets)	LB60+FB

Tall Single Oven Housing Unit

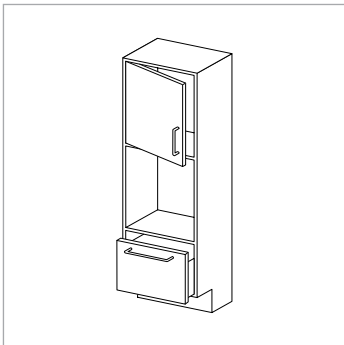

FEATURES

- + Made-to-measure tall unit (height variable)
- + Width: 600mm

Product Code:

600mm Tall Single Oven Housing Unit **TAP60DRL/R**

Tall Single Oven & Microwave Housing Unit

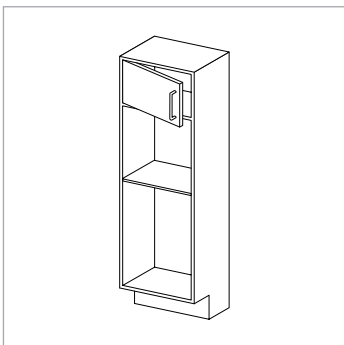

FEATURES

- + Made-to-measure tall unit (height variable)
- + Width: 600mm

Product Code:

600mm Tall Single Oven & Microwave Housing Unit **TAP60SOL/R+M**

Tall Double Oven Housing Unit

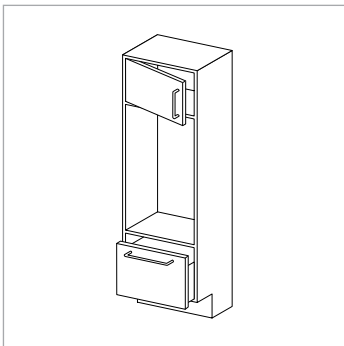

FEATURES

- + Made-to-measure tall unit (height variable)
- + Width: 600mm

Product Code:

600mm Tall Double Oven Housing Unit **TAP60DDRL/R**

Tall Fridge/Freezer Housing Unit

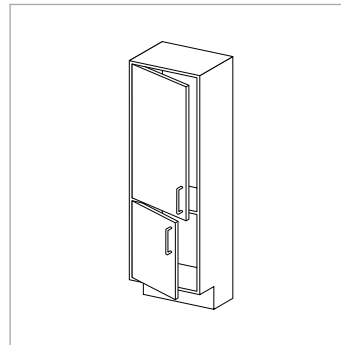

FEATURES

- + Made-to-measure tall unit (height variable)
- + Width: 600mm

Product Code:

600mm Tall Fridge/Freezer Housing Unit **FF60L/R**

Larder/Fridge Unit (1 Drawer)

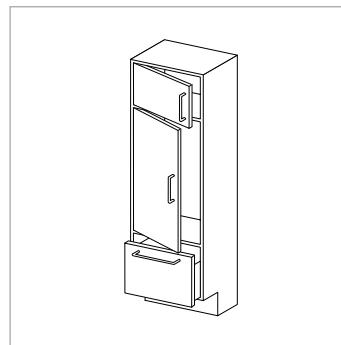

FEATURES

- + Made-to-measure tall unit (height variable)
- + Width: 600mm

Product Code:

600mm Larder/Fridge Unit **FR60DRL/R**

L/R in the product code denotes whether the product is Left or Right handed.

Open Wall Unit

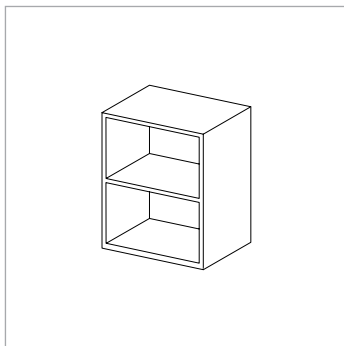

FEATURES

- + Two widths available: 500 or 600mm
- + Height: 735mm

Product Codes:

500mm Open Wall Unit	OS50
600mm Open Wall Unit	OS60

Wall Unit (Single Door)

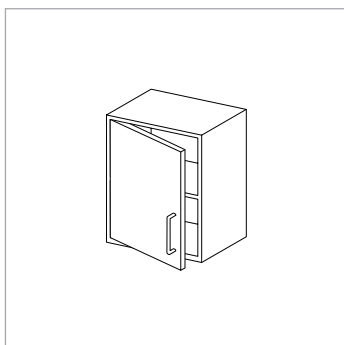

FEATURES

- + Five widths available: 300, 400, 450, 500 or 600mm
- + Height: 735mm

Product Codes:

300mm Wall Unit (Single Door)	W30L/R
400mm Wall Unit (Single Door)	W40L/R
450mm Wall Unit (Single Door)	W45L/R
500mm Wall Unit (Single Door)	W50L/R
600mm Wall Unit (Single Door)	W60L/R

Wall Unit (Double Door)

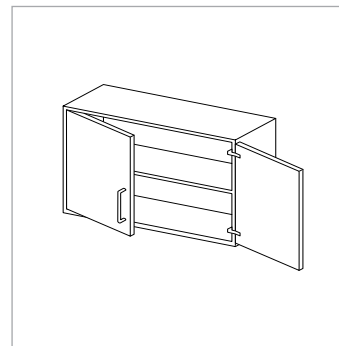

FEATURES

- + Eight widths available: 500, 600, 700, 800, 900, 1000, 1100 or 1200mm
- + Height: 735mm
- + 170° hinges fitted as standard

Product Codes:

500mm Wall Unit (Double Door)	WD50
600mm Wall Unit (Double Door)	WD60
700mm Wall Unit (Double Door)	WD70
800mm Wall Unit (Double Door)	WD80
900mm Wall Unit (Double Door)	WD90
1000mm Wall Unit (Double Door)	WD100
1100mm Wall Unit (Double Door)	WD110
1200mm Wall Unit (Double Door)	WD120

Wall Unit (Single Door with Pull-Down Baskets)

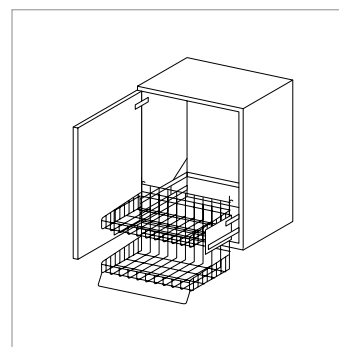

FEATURES

- + Available with or without pull-down baskets
- + Three widths available: 400, 500 or 600mm
- + Height: 735mm
- + 110° hinges fitted as standard

Product Codes:

400mm Wall Unit (Single Door)	WB40L/R
500mm Wall Unit (Single Door)	WB50L/R
600mm Wall Unit (Single Door)	WB60L/R
400mm Wall Unit (Single Door) with Pull-Down Baskets*	WBVL/R40
500mm Wall Unit (Single Door) with Pull-Down Baskets*	WBVL/R50
600mm Wall Unit (Single Door) with Pull-Down Baskets*	WBVL/R60

*V in the product code = variable load up to 10kg

L/R in the product code denotes whether the product is Left or Right handed.

Wall Unit (Double Door with Pull-Down Baskets)

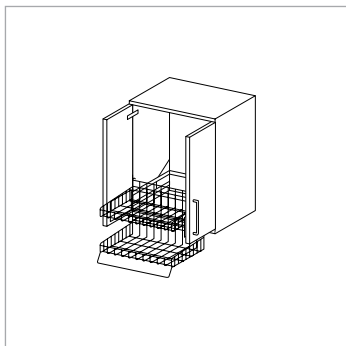

FEATURES

- + Two widths available: 500 or 600mm
- + Height: 735mm
- + 110° hinges fitted as standard

Product Codes:

500mm Wall Unit (Double Door)	WDB50
600mm Wall Unit (Double Door)	WDB60
500mm Wall Unit (Double Door) with Pull-Down Baskets	WDBVL50
600mm Wall Unit (Double Door) with Pull-Down Baskets	WDBVL60

Wall Unit (Top Box)

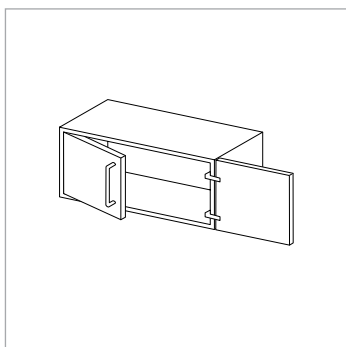

FEATURES

- + Four widths available: 500, 600, 800 or 1000mm
- + Height: 290mm
- + 170° hinges fitted as standard

Product Codes:

500mm Wall Unit (Top Box)	W50TB
600mm Wall Unit (Top Box)	W60TB
800mm Wall Unit (Top Box)	W80TB
1000mm Wall Unit (Top Box)	W100TB

Open End Wall Unit

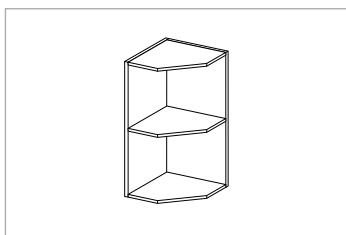

FEATURES

- + Width: 300mm
- + Height: 735mm

Product Code:

300mm Open End Wall Unit	OEW30
--------------------------	--------------

L/R in the product code denotes whether the product is Left or Right handed.

Open Corner Wall Unit

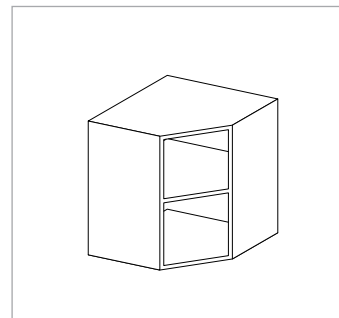

FEATURES

- + Two widths available: 500 or 600mm
- + Height: 735mm

Product Codes:

500mm Open Corner Wall Unit	OCW50
600mm Open Corner Wall Unit	OCW60

Corner Wall Unit (Bi-fold Door)

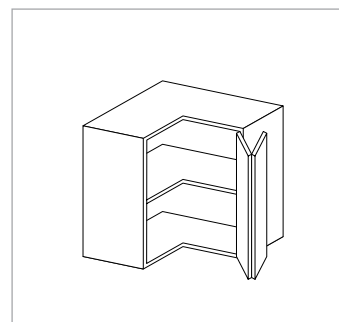

FEATURES

- + Two widths available: 500 or 600mm
- + Height: 735mm

Product Codes:

500mm Corner Wall Unit (Bi-fold Door)	CWL50L/R
600mm Corner Wall Unit (Bi-fold Door)	CWL60L/R

Wall Unit (Four Door)

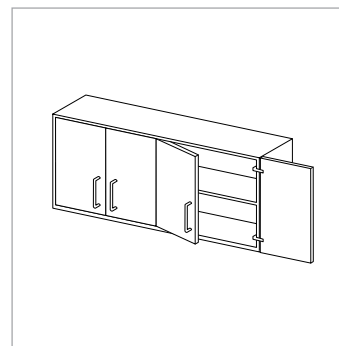

FEATURES

- + Five widths available: 800, 900, 1000, 1100 or 1200mm
- + Height: 735mm

Product Codes:

800mm Wall Unit (Four Door)	WDD80
900mm Wall Unit (Four Door)	WDD90
1000mm Wall Unit (Four Door)	WDD100
1100mm Wall Unit (Four Door)	WDD110
1200mm Wall Unit (Four Door)	WDD120

Base Unit (2 Drawers)

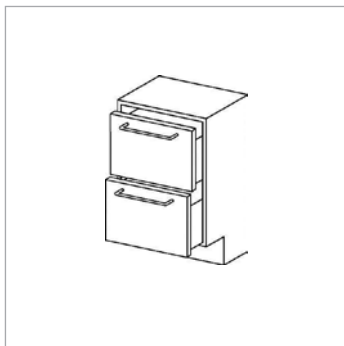

FEATURES

- + Seven widths available: 300, 400, 450, 500, 600, 800 or 1000mm
- + Height: 432 - 657mm

Product Codes:

300mm Base Unit (2 Drawers)	B302DR
400mm Base Unit (2 Drawers)	B402DR
450mm Base Unit (2 Drawers)	B452DR
500mm Base Unit (2 Drawers)	B502DR
600mm Base Unit (2 Drawers)	B602DR
800mm Base Unit (2 Drawers)	B802DR
1000mm Base Unit (2 Drawers)	B1002DR

Base Unit (3 Drawers)

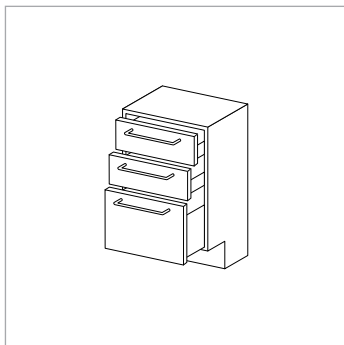

FEATURES

- + Six widths available: 300, 400, 450, 500, 600 or 800mm
- + Height: 432 - 657mm

Product Codes:

300mm Base Unit (3 Drawers)	B303DR
400mm Base Unit (3 Drawers)	B403DR
450mm Base Unit (3 Drawers)	B453DR
500mm Base Unit (3 Drawers)	B503DR
600mm Base Unit (3 Drawers)	B603DR
800mm Base Unit (3 Drawers)	B803DR

Highline Base Unit (Single Door)

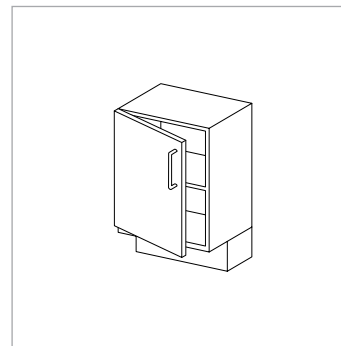

FEATURES

- + Five widths available: 300, 400, 450, 500, 600mm
- + Height: 432 - 657mm

Product Codes:

300mm Highline Base Unit (Single Door)	B30HLL/R
400mm Highline Base Unit (Single Door)	B40HLL/R
450mm Highline Base Unit (Single Door)	B45HLL/R
500mm Highline Base Unit (Single Door)	B50HLL/R
600mm Highline Base Unit (Single Door)	B60HLL/R

Planning Tip: We recommend pull-out baskets for disabled use with these units.

Highline Base Unit (Double Door)

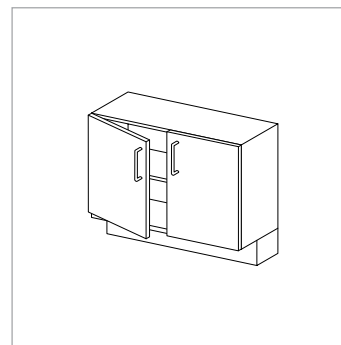

FEATURES

- + Four widths available: 800, 1000, 1100 or 1200mm
- + Height: 432 - 657mm

Product Codes:

800mm Highline Base Unit (Double Door)	B80HL
1000mm Highline Base Unit (Double Door)	B100HL
1100mm Highline Base Unit (Double Door)	B110HL
1200mm Highline Base Unit (Double Door)	B120HL

Planning Tip: We recommend pull-out baskets for disabled use with these units.

L/R in the product code denotes whether the product is Left or Right handed.

Highline Base Unit (Single Door with 2 Baskets)

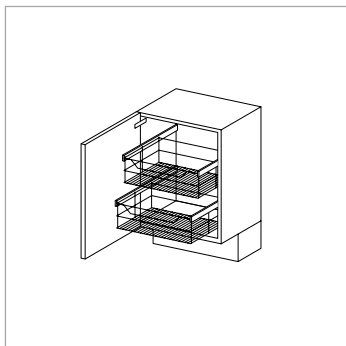

FEATURES

- + Includes baskets, fixing brackets and runners
- + Four widths available: 400, 450, 500 or 600mm
- + Height: 432 - 657mm

Product Codes:

400mm Highline Base Unit (Single Door with 2 Baskets)	B40BAL/R
450mm Highline Base Unit (Single Door with 2 Baskets)	B45BAL/R
500mm Highline Base Unit (Single Door with 2 Baskets)	B50BAL/R
600mm Highline Base Unit (Single Door with 2 Baskets)	B60BAL/R

Highline Base Unit (Double Door with 4 Baskets)

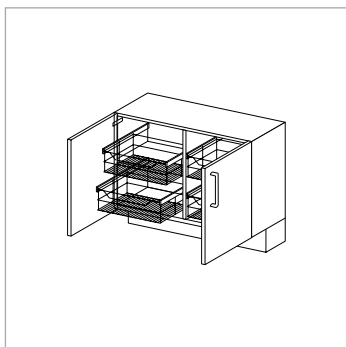

FEATURES

- + Includes baskets, fixing brackets and runners
- + Three widths available: 800, 1000 or 1200mm
- + Height: 432 - 657mm

Product Codes:

800mm Highline Base Unit (Double Door with 4 Baskets)	B80BA
1000mm Highline Base Unit (Double Door with 4 Baskets)	B100BA
1200mm Highline Base Unit (Double Door with 4 Baskets)	B120BA

Base Unit (3 Drawers with Pull-Out Table)

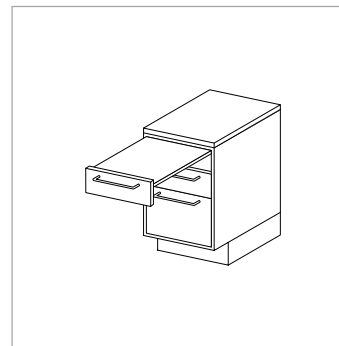

FEATURES

- + Pull-out table extends to 800mm
- + Two widths available: 500 or 600mm
- + Height: 432 - 657mm

Product Codes:

500mm Base Unit (3 Drawers with Pull-Out Table)	B503DR+POT
600mm Base Unit (3 Drawers with Pull-Out Table)	B603DR+POT

Base Unit (3 Drawers with Pull-Out Ironing Board)

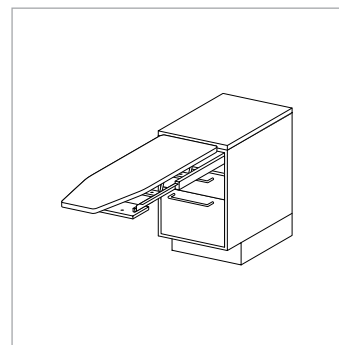

FEATURES

- + Pull-out ironing board extends to 950mm
- + Three widths available: 400, 450 or 500mm
- + Height: 432 - 657mm

Product Codes:

400mm Base Unit (3 Drawers with Pull-Out Ironing Board)	B403DR+PIB
450mm Base Unit (3 Drawers with Pull-Out Ironing Board)	B453DR+PIB
500mm Base Unit (3 Drawers with Pull-Out Ironing Board)	B503DR+PIB

Base Unit (3 Drawers with Pull-Out Heat Drawer & Worktop Saver)

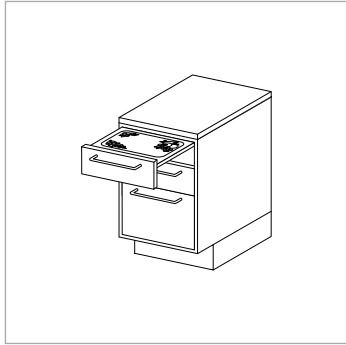

FEATURES

- + Four widths available: 400, 450, 500 or 600mm
- + Height: 432 - 657mm

Product Codes:

400mm Base Unit (3 Drawers) (with Pull-Out Heat Drawer & Worktop Saver)	B403DR+HD
450mm Base Unit (3 Drawers) (with Pull-Out Heat Drawer & Worktop Saver)	B453DR+HD
500mm Base Unit (3 Drawers) (with Pull-Out Heat Drawer & Worktop Saver)	B503DR+HD
600mm Base Unit (3 Drawers) (with Pull-Out Heat Drawer & Worktop Saver)	B603DR+HD

Open End Base Unit

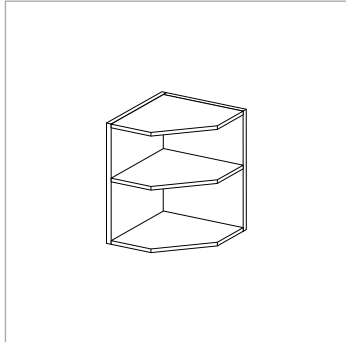

FEATURES

- + Width: 300 x 560mm
- + Height: 432 - 657mm

Product Code:

300mm Open End Base Unit	OEBL/R
--------------------------	---------------

Under Worktop Bridging Unit

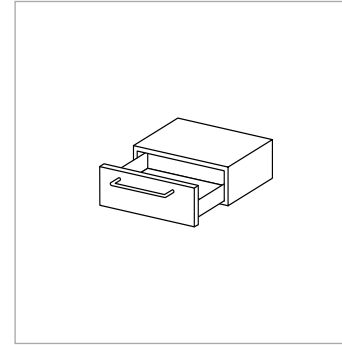

FEATURES

- + Five widths available: 300, 400, 450, 500 or 600mm

Product Codes:

300mm Under Worktop Bridging Unit	BRI30
400mm Under Worktop Bridging Unit	BRI40
450mm Under Worktop Bridging Unit	BRI45
500mm Under Worktop Bridging Unit	BRI50
600mm Under Worktop Bridging Unit	BRI60

Under Worktop Pull-Out Heat Drawer & Chopping Board

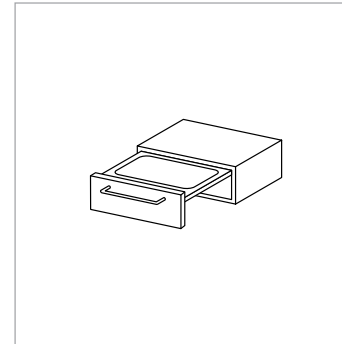

FEATURES

- + Five widths available: 400, 450, 500, 600 or 650mm

Product Codes:

400mm Under Worktop Pull-Out Heat Drawer & Chopping Board	BRI40+HD
450mm Under Worktop Pull-Out Heat Drawer & Chopping Board	BRI45+HD
500mm Under Worktop Pull-Out Heat Drawer & Chopping Board	BRI50+HD
600mm Under Worktop Pull-Out Heat Drawer & Chopping Board	BRI60+HD
650mm Under Worktop Pull-Out Heat Drawer & Chopping Board	BRI65+HD

L/R in the product code denotes whether the product is Left or Right handed.

Under Worktop Bridging Unit Pull-Out Ironing Board

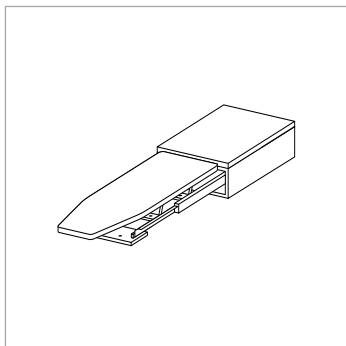

FEATURES

- + Three widths available: 400, 450 or 500mm

Product Codes:

400mm Under Worktop Pull-Out Ironing Board	BR140+PIB
450mm Under Worktop Pull-Out Ironing Board	BR145+PIB
500mm Under Worktop Pull-Out Ironing Board	BR150+PIB

Under Worktop Bridging Unit Pull-Out Table

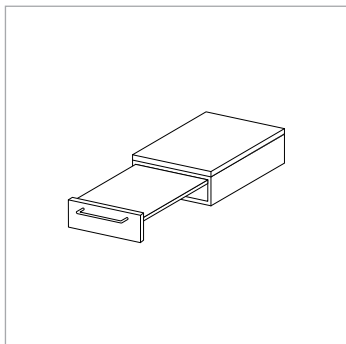

FEATURES

- + Two widths available: 500 or 600mm

Product Codes:

500mm Open End Base Unit	BR150+POT
600mm Open End Base Unit	BR160+POT

Trolley Unit (Single Door)

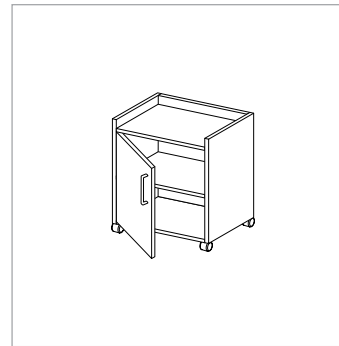

FEATURES

- + Two widths available: 500 or 600mm
- + Height: 432 - 657mm

Product Codes:

500mm Trolley Unit (Single Door)	T50HLL/R
600mm Trolley Unit (Single Door)	T60HLL/R

Trolley Unit (Double Drawer)

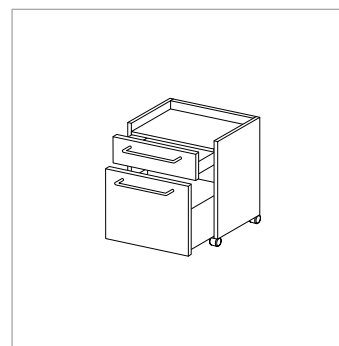

FEATURES

- + Two widths available: 500 or 600mm
- + Height: 432 - 657mm

Product Codes:

500mm Trolley Unit (Double Drawer)	T502DR
600mm Trolley Unit (Double Drawer)	T602DR

Trolley Unit (with Waste Bin)

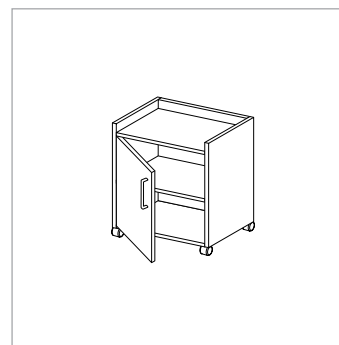

FEATURES

- + Two widths available: 500 or 600mm
- + Height: 432 - 657mm

Product Codes:

500mm Trolley Unit (Double Drawer)	T50WBL/R
600mm Trolley Unit (Double Drawer)	T60WBL/R

L/R in the product code denotes whether the product is Left or Right handed.

Corner 3/4 Carousel Unit

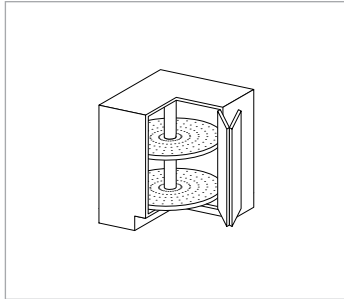

FEATURES

- + Two widths available: 800 or 900mm
- + Height: 575mm

Product Code:

800mm Corner 3/4 Carousel Unit **BLCH80L/R**
 900mm Corner 3/4 Carousel Unit **BLCH90L/R**

Corner Semi Circle Carousel Unit

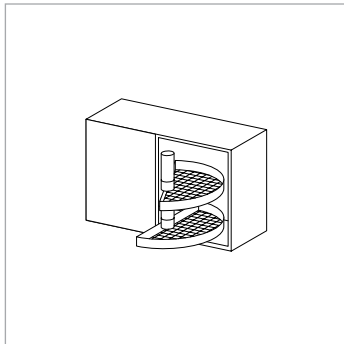

FEATURES

- + Width: 1000mm, Height: 575mm
- + Two door sizes available: 400 or 500mm

Product Codes:

Corner Semi Circle Carousel Unit (400mm Door) **BCH1004L/R**
 Corner Semi Circle Carousel Unit (500mm Door) **BCH1005L/R**

Diagram shown is left hand blank.

Corner Slide-Out Carousel Unit

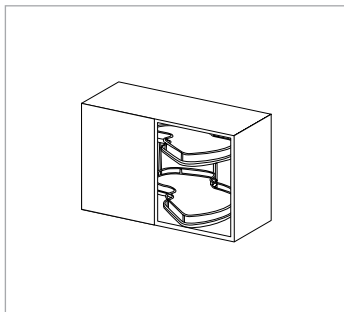

FEATURES

- + Width: 1000mm, Height: 575mm, Door: 500mm

Product Codes:

Left Door Corner Slide-Out Carousel Unit **BCS100/5L**
 Right Door Corner Slide-Out Carousel Unit **BCS100/5R**

Diagram shown is left hand blank. Only available for corner units with a door of 500mm or greater.

L/R in the product code denotes whether the product is Left or Right handed.

INDEPENDENCE DOOR COLOUR OPTIONS

Independence Door Options



2mm Edged Door Saponetta Door Shaker Door Slab Door

*Available in Matt finish.

†Available in Gloss finish.

The colours in this brochure are for reference only and the item should be seen prior to purchase.

Independence Door Colour Options



White *† Super White Ash White Avola Alabaster Paint Effect Ivory Oak

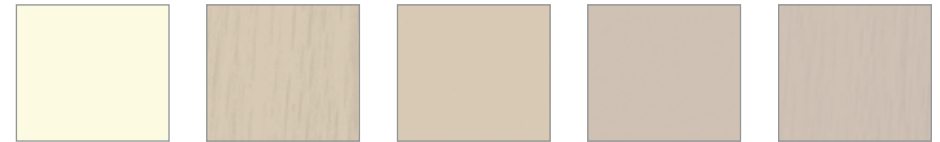

Ivory Paint Effect Mussel Oak Mussel *† Cashmere *† Paint Effect Cashmere Oak



Paint Effect Dakar Oak Dakar *† Ellmau Beech Hi-Gloss Red † Light Sorano Oak



Winchester Oak Sonoma Natural Oak Grey Bardolino Oak Stone Grey *† Paint Effect Stone Grey Oak



Dust Grey † Paint Effect Dust Grey Graphite *† Paint Effect Graphite Driftwood

Liberty Kitchen

The Liberty Kitchen range is easy to assemble, so your dream kitchen can become a reality in no time. Simple, affordable and with a range of worktop, door, accessory and appliance options, now you can easily have the kitchen you've always wanted.



LIBERTY UNIT OPTIONS

Tall Single Oven Housing Unit



FEATURES

- + Width: 600mm, Height: 1719mm
- + Available with drawers or door

Product Codes:

Tall Single Oven Housing Unit (Drawers)	LIBAHDRLR
Tall Single Oven Housing Unit (Door)	LIBAHFLR

Tall Larder/Broom Unit

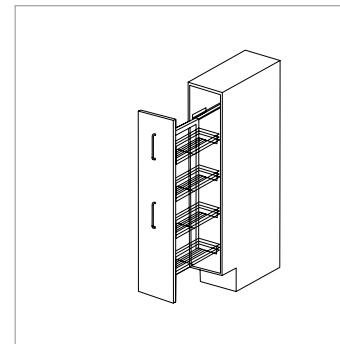

FEATURES

- + Three widths available: 300, 500 or 600mm
- + Height: 1719mm
- + Pull-out baskets can be supplied for these items (optional extra)

Product Codes:

300mm Tall Larder/Broom Unit	LIBLB36LR
500mm Tall Larder/Broom Unit	LIBLB56LR
600mm Tall Larder/Broom Unit	LIBLB66LR

Wall Unit (Single Door)

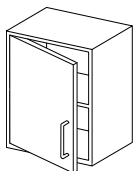

FEATURES

- + Three widths available: 300, 400 or 500mm
- + Height: 735mm
- + Pull-down baskets can be supplied for 400mm and 500mm sizes (optional extra)

Product Codes:

300mm Wall Unit (Single Door)	LIB533WLR
400mm Wall Unit (Single Door)	LIB543WLR
500mm Wall Unit (Single Door)	LIB553WLR

Wall Unit (Double Door)

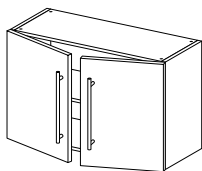

FEATURES

- + Two widths available: 600 or 1000mm
- + Height: 735mm
- + Pull-down baskets can be supplied for 600mm (optional extra)

Product Codes:

600mm Wall Unit (Double Door)	LIB563W2D
1000mm Wall Unit (Double Door)	LIB5103W2D

Corner Wall Unit (Double Door)

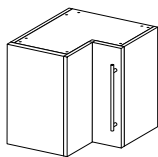

FEATURES

- + Width: 625 x 625mm, Height: 735mm

Product Code:

Corner Wall Unit (Double Door)	LIB633CWLR
--------------------------------	-------------------

Base Unit (3 Drawers)

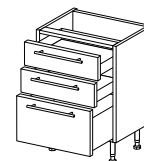

FEATURES

- + Two widths available: 300 or 500mm
- + Height: 588mm
- + Heat drawer, pull-out ironing board and pull-out table available for 500mm size (optional extra)

Product Codes:

300mm Base Unit (3 Drawers)	LIB536DR3
500mm Base Unit (3 Drawers)	LIB56DR3

Highline Base Unit (Single Door)

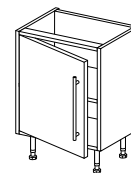

FEATURES

- + Four widths available: 300, 400, 500 or 600mm
- + Height: 588mm

Product Codes:

300mm Highline Base Unit (Single Door)	LIB536FLR
400mm* Highline Base Unit (Single Door)	LIB546FLR
500mm* Highline Base Unit (Single Door)	LIB556FLR
600mm* Highline Base Unit (Single Door)	LIB566FLR

***Planning Tip:** We recommend pull-out baskets for disabled use with these units (optional extra).

Corner Base Unit (Double Door)

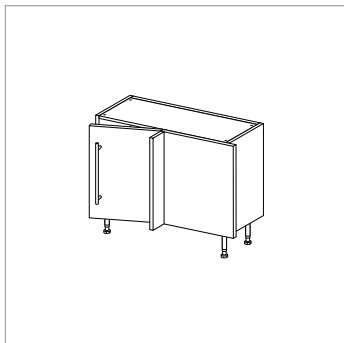

FEATURES

- + Width: 1000mm, Height: 588mm
- + 500mm door and 625mm blank (1125mm O/A)
- + Carousels are available for this item (optional extra)

Product Code:

Corner Base Unit (Double Door) **LIB5106C5LR**

Diagram shown is right hand blank.

Base Unit (2 Drawers)

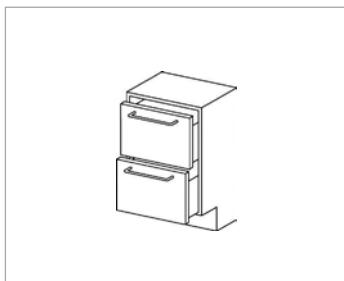

FEATURES

- + Width: 600mm, Height: 588mm

Product Code:

600mm Base Unit (2 Drawers) **LIB566DR2**

Base Unit (Double Door)

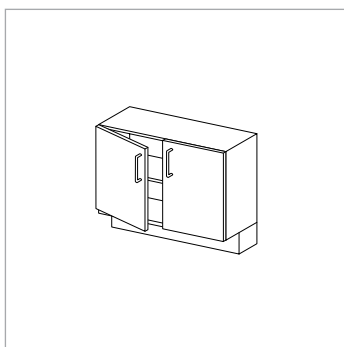

FEATURES

- + Width: 1000mm, Height: 588mm

Product Code:

1000mm Base Unit (Double Door) **LIB5106LR**

Liberty Accessories

Worktop Support Panel

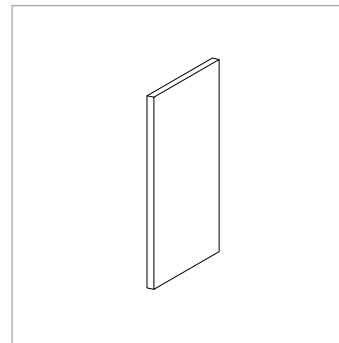

FEATURES

- + Available in: Beech, Maple, Oak & White

Product Codes:

Beech Worktop Support Panel	KNBEWS
Maple Worktop Support Panel	LMPEWS
Oak Worktop Support Panel	KNOEWS
White Worktop Support Panel	LGLEWS

Decor End Panel (Wall Units)

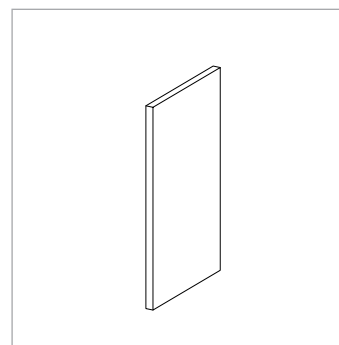

FEATURES

- + Available in: Beech, Maple, Oak & White

Product Codes:

Beech Decor End Panel (Wall Units)	LNBDWPM
Maple Decor End Panel (Wall Units)	LMPDWPM
Oak Decor End Panel (Wall Units)	LNODWPM
White Decor End Panel (Wall Units)	LGLDWPM

Custom Fit Panels

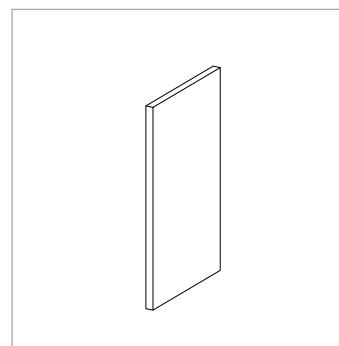

FEATURES

- + Available in: Beech, Maple, Oak & White

Product Codes:

Beech Custom Fit Panel	LNBZCFP
Maple Custom Fit Panel	LMPCFP
Oak Custom Fit Panel	LNOCFP
White Custom Fit Panel	LGLCFP

Plinth

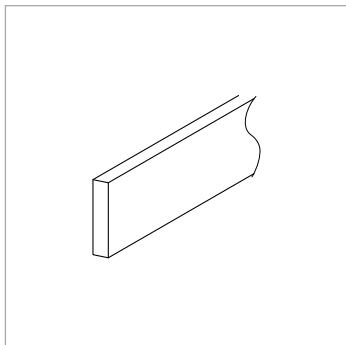

FEATURES

- + Width: 2500mm, Height: 300mm
- + Available in: Beech, Maple, Oak & White

Product Codes:

Beech Plinth	LNBKCP25
Maple Plinth	LMPIKCP25
Oak Plinth	LNOIKCP25
White Plinth	LGWIKCP25

Joining Strip Corner Pattern

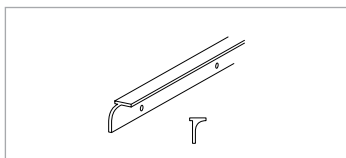

Product Code:

Corner Joining Strip	MJS
----------------------	-----

Worktop Bolts

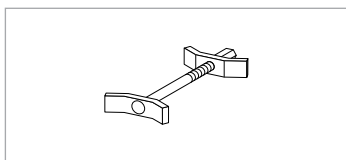

Product Code:

Worktop Bolts (Pair)	WTBT
----------------------	------

Heavy Duty Worktop Bracket

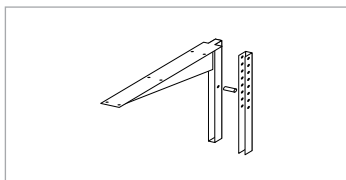

Product Code:

Heavy Duty Worktop Bracket	HDWTBK
----------------------------	--------

Chrome Supporting Leg

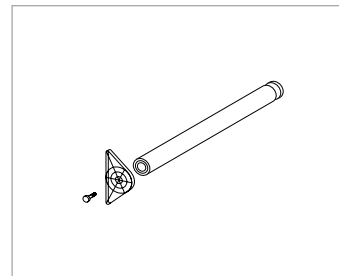

FEATURES

- + Diameter: 60mm
- + Adjustable height

Product Code:

Chrome Supporting Leg	LEG
-----------------------	-----

Worktop Saver

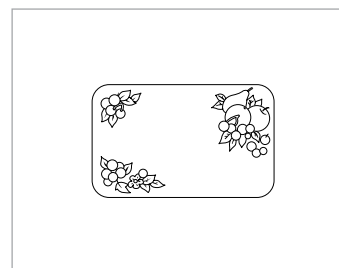

FEATURES

- + Heatproof cutting surface
- + Virtually unbreakable

Product Code:

Worktop Saver	WTS
---------------	-----

Waste Bin

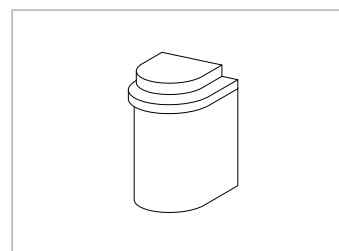

FEATURES

- + PVC self-opening waste bin

Product Code:

Waste Bin	WB
-----------	----

Telescopic Towel Rails

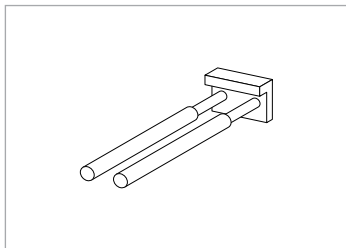

Product Code:

Telescopic Towel Rails

TTR

LIBERTY DOOR COLOUR OPTIONS

All Liberty kitchens are supplied with white cabinets/carcasses. Four door colour options are available.

Cabinet Colour:



White

Independence Door Colour Options



White



Light Maple



Light Oak



Light Beech

Kitchen Options

Choose from our extensive range of options and appliances to personally tailor your kitchen.



DOOR HANDLES

Satin Nickel Bow Handle



FEATURES

+ Available with 128mm or 160mm centres

Product Codes:

128mm Satin Nickel Bow Handle	LIBACC001
160mm Satin Nickel Bow Handle	LIBACC002

D Handle



FEATURES

+ Available with 128mm or 160mm centres

Product Codes:

128mm D Handle (Satin)	LIBACC003
160mm D Handle (Satin)	LIBACC004

Chrome D Handle



FEATURES

+ Available with 160mm centre

Product Code:

160mm Chrome D Handle	HDL
-----------------------	------------

Brushed Steel Flat D Handle



Product Code:

160mm Brushed Steel Flat D Handle	LIBACC007
-----------------------------------	------------------

Square Ends Bar Handle



FEATURES

+ Available with 128mm or 160mm centres

Product Codes:

128mm Square Ends Bar Handle **LIBACC005**

160mm Square Ends Bar Handle **LIBACC006**

Splayed Oval Tube Handle



FEATURES

+ Available with 160mm centre

Product Code:

160mm Splayed Oval Tube Handle **HDLOVAL**

Aries Bar Handle



FEATURES

+ Available with 160mm centre

Product Code:

160mm Aries Bar Handle **HDLBAR**

WORKTOPS

Colour Options:

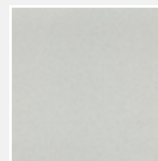

Luna Beige



Aticos Gold Surf



Kota Surf



Slate Roche



Maryland Fonce Surf



Midnight

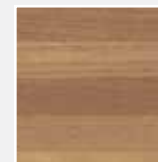

Butcher Block Medium

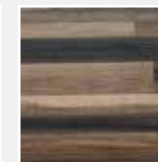

Ebony Stripwood



Antique Block Walnut



Tobacco Oak Ultra Matt

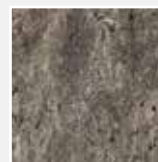

Andora Brown Granite

Worktop



FEATURES

+ Supplied as standard worktop. Length and corners can be customised on site by your installer.

Product Codes:

Worktop 3000mm **WT403**

Worktop 4000mm **WT404**

APPLIANCES

Beko Stainless Steel Single Oven



FEATURES

- + Upper and lower heating elements for even cooking
- + Telescopic rails included
- + Available left or right-hand hinged

Product Code:

Beko Stainless Steel Single Oven **BEOVL/R**

CDA Stainless Steel Single Oven



FEATURES

- + Integrated anti-tilt shelves
- + Reversible side opening door (reversible hinges)
- + Touch control, programmable clock/timer

Product Code:

CDA Stainless Steel Single Oven **LIBAPP096**

Neff Stainless Steel Single Oven



FEATURES

- + Slide&Hide® fully retracting oven door
- + CircoTherm® heat system for even cooking on three levels
- + Self-cleaning catalytic coating
- + Telescopic Rail included

Product Code:

Neff Stainless Steel Single Oven **LIBAPP030**

Zanussi Stainless Steel Single Oven



FEATURES

- + Heat activated catalytic cleaning
- + Telescopic rails included
- + Fan cooled double glazed door
- + Available left or right-hand hinged

Product Code:

Zanussi Stainless Steel Single Oven **ZOVSL/R**

Zanussi White Single Oven



FEATURES

- + Heat activated catalytic cleaning
- + Telescopic rails included
- + Fan cooled double glazed door
- + Available left or right-hand hinged

Product Code:

Zanussi White Single Oven **ZOVSWL/R**

Induction Hob



FEATURES

- + The safest and most inclusive type of hob
- + Heat is only activated when a magnetic pan is placed on top
- + No residual heat makes it suitable as a work surface
- + Front or touch controls
- + Available in 2 or 4 zone options

Products:

2 Zone Induction Hob
4 Zone Induction Hob

Ceramic Hob

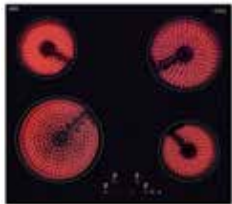

FEATURES

- + Residual heat warning indicator for safety
- + Front or touch controls as standard
- + Low profile surface ideal for limited dexterity
- + No specialist pans required
- + Available in 2 or 4 zone options

Products:

2 Zone Ceramic Hob
4 Zone Ceramic Hob

Electric Hob



FEATURES

- + Front controls as standard
- + Space saving 'Domino' twin burner option
- + Superb budget option
- + Low profile surface provides easy access
- + Available in 2 or 4 zone options

Products:

2 Zone Electric Hob
4 Zone Electric Hob

Gas Hob



FEATURES

- + Not recommended for accessible kitchens due to open flame and raised pan position
- + Front controls as standard for ease
- + Flame safe technology turns off gas if flame goes out
- + Available in 2 or 4 zone options

Products:

2 Zone Gas Hob
4 Zone Gas Hob

There are many options available on the products listed above.
Please call the **Kitchen Department** on 01905 823 298 for details.

There are many options available on the products listed above.
Please call the **Kitchen Department** on 01905 823 298 for details.

Beko Extractor Hood



FEATURES

- + Variable 3-speed control
- + 1 x 40W Halogen light
- + Twin grease filters

Product Code:

Beko Extractor Hood

ZEXX

CDA Curved Glass Chimney Extractor Hood



FEATURES

- + Ducted/Re-circulating
- + Aluminium grease filters
- + 2 x 20W Halogen lights

Product Code:

CDA Curved Glass Chimney Extractor

LIBAPP013

CDA Stainless Steel Traditional Extractor Hood



FEATURES

- + Push button control
- + Aluminium grease filter
- + 1 x 28W Halogen light

Product Code:

CDA Stainless Steel Traditional Extractor LIBAPP006

Zanussi Traditional White Extractor Hood



FEATURES

- + Variable 3-speed control
- + Grease filter with saturation indicator

Product Code:

Zanussi Traditional White Extractor Hood

ZEXW

CDA Stainless Steel Chimney Extractor Hood



FEATURES

- + Ducted/Re-circulating
- + 2 x 50W Halogen lights
- + Twin fan motor

Product Code:

CDA Stainless Steel Chimney Extractor

LIBAPP010

140mm Deep Reversible Monobloc Tap Sink



FEATURES

- + Extra deep bowl
- + For use with single mixer tap
- + Can be installed with drainer on left or right to suit
- + Insulated version protects wheelchair users' legs from scalding

Product Codes:

140mm Deep Reversible Monobloc Tap Sink **EL860**
140mm Deep Reversible Monobloc Tap Sink **EL860S**
(Insulated Bowl)

127mm Deep Monobloc Tap Sink



FEATURES

- + Deep bowl
- + For use with single mixer tap
- + Insulated version available
- + Available with left or right-hand drainer

Product Codes:

127mm Deep Monobloc Tap Sink **SD1271L/R**
127mm Deep Monobloc Tap Sink **SD1271L/RS**
(Insulated Bowl)

127mm Deep Reversible 1.5 Bowl Sink



FEATURES

- + Shallow half bowl is ideal for wheelchair users
- + Half bowl: 90mm deep – Main bowl: 127mm deep
- + Can be installed with drainer on left or right to suit

Product Code:

127mm Deep Reversible 1.5 Bowl Sink **SD12715**

127mm Deep Pillar/Deck Tap Sink



FEATURES

- + Deep bowl
- + For use with two taps (pillar/deck)
- + Insulated version available
- + Available with left or right-hand drainer

Product Codes:

127mm Deep 2 Tap Hole Sink **SD1272L/R**
127mm Deep 2 Tap Hole Sink **SD1272L/RS**
(Insulated Bowl)

950x508mm Shallow Stainless Steel Sink Reversible 1TH



FEATURES

- + Durable and resistant to high temperature, will not rust, stain or tarnish – easy maintenance.
- + 18/10 stainless steel, 0.6mm gauge
- + Shallow bowl with 120mm depth
- + Can be installed left or right handed
- + For use with single mixer tap

Product Codes:

Shallow Stainless Steel Sink Reversible 1TH **SD1201**
Shallow Stainless Steel Sink Reversible 1TH
(Insulated Bowl) **SD1201S**

950x508mm Shallow Bowl Stainless Steel Sink 2TH



FEATURES

- + Durable and resistant to high temperature, will not rust, stain or tarnish – easy maintenance.
- + 18/10 stainless steel, 0.6mm gauge
- + Shallow bowl with 120mm depth
- + Can be installed left or right handed
- + Can be installed with drainer left or right to suit

Product Codes:

Shallow Bowl Stainless Steel Sink 2TH	SD1202L
Shallow Bowl Stainless Steel Sink 2TH	SD1202R
Shallow Stainless Steel Sink Reversible 2TH (Insulated Bowl)	SD1202LS
Shallow Stainless Steel Sink Reversible 2TH (Insulated Bowl)	SD1202RS

150mm Deep Round Bowl



FEATURES

- + Shallow bowl design
- + Stylish round bowl can be inset into worktops

Product Code:

150mm Deep Round Bowl **RB**

Round Drainer



FEATURES

- + Accompanies round bowl
- + Provides useful and stylish drainage surface

Product Code:

Round Drainer **RD**

3" Single Lever Monobloc Mixer Tap



Product Code:

3" Single Lever Monobloc Mixer Tap **LEV13**

9" Single Lever Monobloc Mixer Tap



Product Code:

9" Single Lever Monobloc Mixer Tap **LEV19**

3" Dual Lever Monobloc Mixer Tap



Product Code:

3" Dual Lever Monobloc Mixer Tap **LEV23**

High Neck Pillar Taps (Pair)



FEATURES

- + Available with 3" and 6" levers

Product Codes:

3" Lever High Neck Pillar Taps (Pair)	LEV03
6" Lever High Neck Pillar Taps (Pair)	LEV06



Support

INSTALLATION & PRODUCT GUIDES

370

Choosing The Right Product	371
Shower Trays Installation	372
Braddan	372
Mullen®	375
Sulby	377
Low Profile	379
Wet Room Formers Installation	380
Tuff Form®	380
Wall Panels Installation	383
Waste Pumps Installation	384
DigiPump	384
Screedmaster	385
Doc M Installation	386

USEFUL INFORMATION

388

Product Index	389
Visit AKW	393
General Information	394
Product Information	394
Legal Information	395
Terms & Conditions	396



Installation & Product Guides

Whether fitting a wet room on a timber floor or a Doc M installation, AKW always ensure comprehensive installation instructions are available for our products.



Choosing the right products

Here is an easy-to-use reference to help you choose your shower tray/wet room former, shower screen and accessories.

STEP 1: CHOOSE A SHOWER TRAY/WET ROOM FORMER

You'll find all our shower trays from page 48.

- + **Floor type:** AKW shower trays are designed for different types of floors e.g. wooden, solid concrete floors (which could be unbreachable) or a screeded floor.
- + **Tray type:** Where is your shower tray going to be fitted? In a corner, or an alcove? Does it need to be cut to fit a particular size? Many of our trays are bath replacements and are therefore handed to the waste end.
- + **Drainage:** Most AKW trays will accommodate gravity or pumped wastes – indeed, some come with them already built-in. If your shower enclosure requires waste water to be pumped away, we have a wide selection of drainage pumps (see wastes on [p176](#) and [p39](#)).



Please note: AKW shower trays are not generally for use with power showers or high flow systems.

STEP 2: CHOOSE A SHOWER SCREEN

Once you've chosen the tray, the next step is to specify a suitable shower screen (page 78).

- + **Entry & Access:** It's important to think about how the shower screen opens (the entry path), so that there's space for other fittings such as the wash basin and toilet. Our shower screens are handed in the same manner as the trays, according to waste end. Compatible screens all available options.

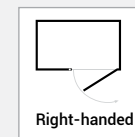

STEP 3: ACCESSORIES

AKW offers a huge selection of shower seats, grab rails, showering aids and washroom products (page 261 and 209).

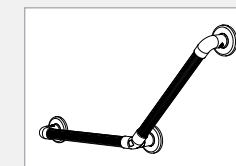

SHOWER TRAY INSTALLATION GUIDES

Braddan Shower Tray: Concrete Floor Installation Guide

Braddan installed on concrete floor. Features the AKW Standard 50mm Pumped Waste, alternatively, the factory fitted AKW Upward Discharge Waste can be specified. Ramp available (40mm).

- + Standard 50mm Pumped Waste
- + Low level access
- + Trays need to be supported evenly on all four sides underneath
- + No underfoam required

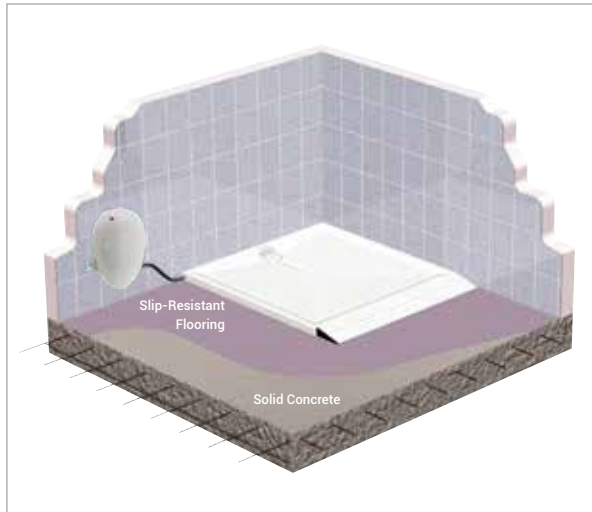

Standard Pump Waste

- + Standard pump waste unit with built-in filter can be opened for easy cleaning
- + Recessed slightly into the concrete floor. Depth below tray: 38mm



40mm Ramp System

- + Ramp system is suitable for wheelchair use
- + Low level access

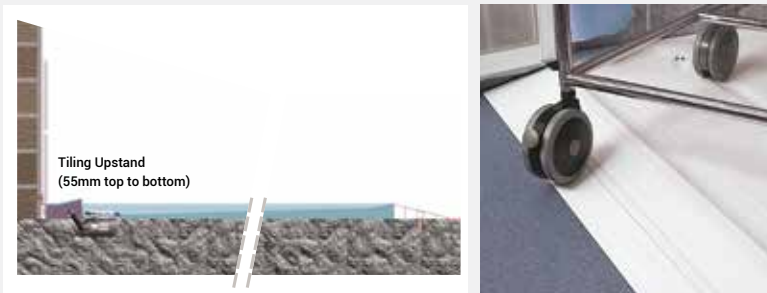

Please Note: Trays are shown in colour for illustrative purposes only.

Braddan Shower Tray: Screeded Floor Installation Guide

Braddan installed in a screed on concrete beams or solid concrete using an AKW M11 DigiPump with a factory fitted AKW Upward discharge waste.

- + Upward Discharge Waste
- + Level access
- + Trays need to be supported evenly on all four sides underneath
- + No underfoam required

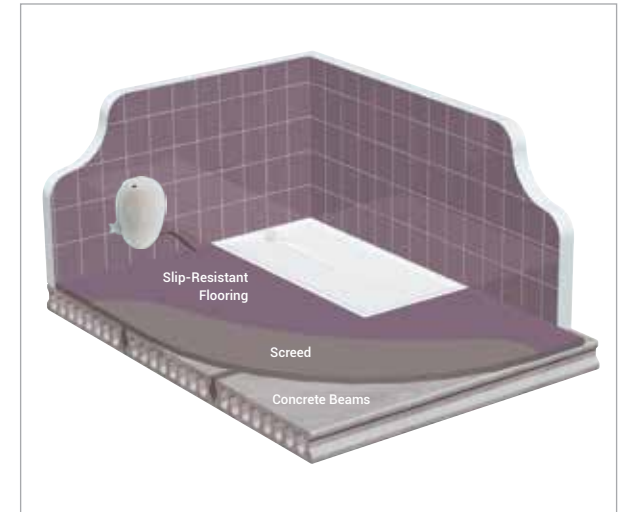

Upward Discharge Waste

- + The upward discharge unit can be opened for easy cleaning
- + Speedfit connects to the back of the discharge and leads to the pump



Level Access Tray

- + No ramp is needed with a screeded floor installation



Please Note: Trays are shown in colour for illustrative purposes only.

Braddan Shower Tray: Wooden Floor Installation Guide

Braddan inset onto joists in a wooden floor, featuring the AKW 20mm Ramp Kit and the AKW Standard 50mm Gravity Waste.

- + Standard 50mm Gravity Waste
- + Low level access
- + Trays need to be supported on all four sides underneath and with cross braces
- + No underfoam required

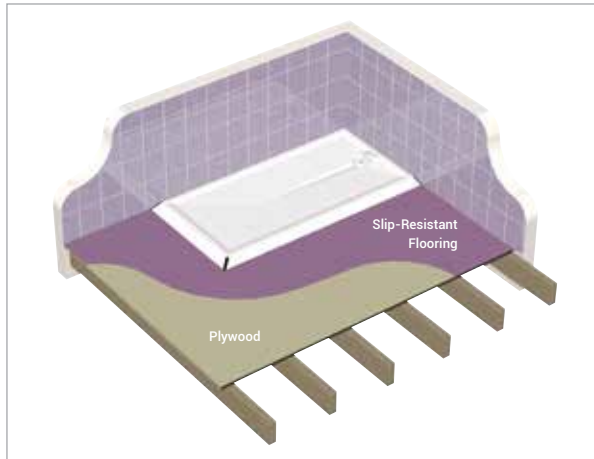

Standard 50mm Gravity Waste

- + Standard 50mm gravity waste can be opened for easy cleaning



20mm Ramp System

- + Ramp system is suitable for wheelchair use
- + Low level access

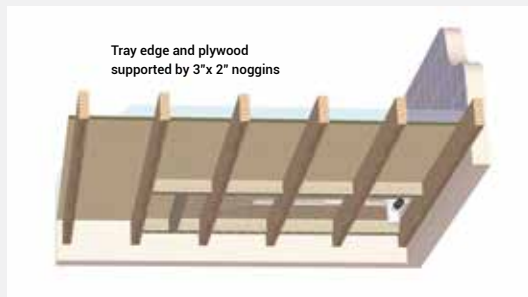

Please Note: Trays are shown in colour for illustrative purposes only. Although many customers fit Braddan trays on wooden floors without difficulty it is important to check that the central waste will avoid the joist.

Mullen® Shower Tray: Screeded Floor Installation Guide

Slippage or float during installation is eliminated by the ribbed design of the underside which allows the tray to key into soft cement or screed.

- + AKW 90mm Pumped Waste
- + Level access
- + Trays need to be supported on all four sides underneath and with cross braces
- + No underfoam required

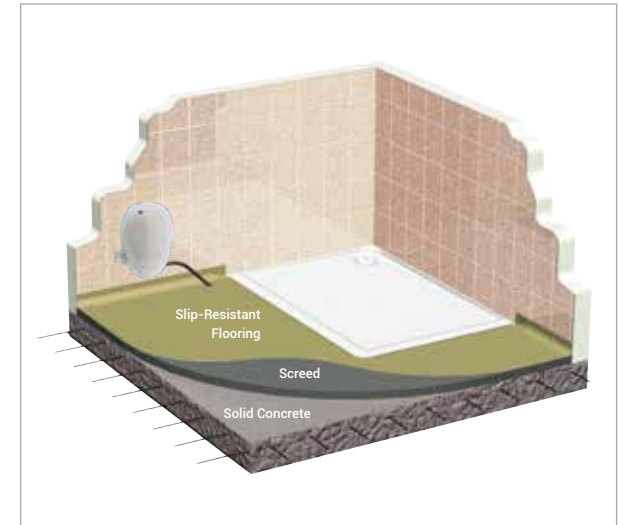

90mm Pumped Waste

- + A wide bodied top clearing pumped waste makes it easy to clean and roddable
- + Pump gulley with two baffle features help to reduce the noise during showering cycles



Level Access Tray

- + No ramp is needed with a screeded floor installation

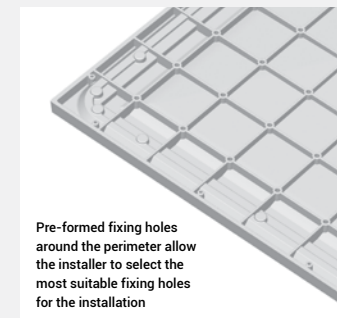
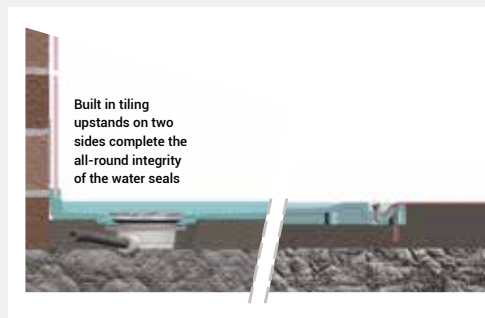

Please Note: Trays are shown in colour for illustrative purposes only.

Mullen® Shower Tray: Wooden Floor Installation Guide

Slippage or float during installation is eliminated by the ribbed design of the underside which allows the tray to key into soft cement or screed.

- + AKW 90mm Gravity Waste
- + Level access
- + Trays need to be supported on all four sides underneath and with cross braces
- + No underfoam required

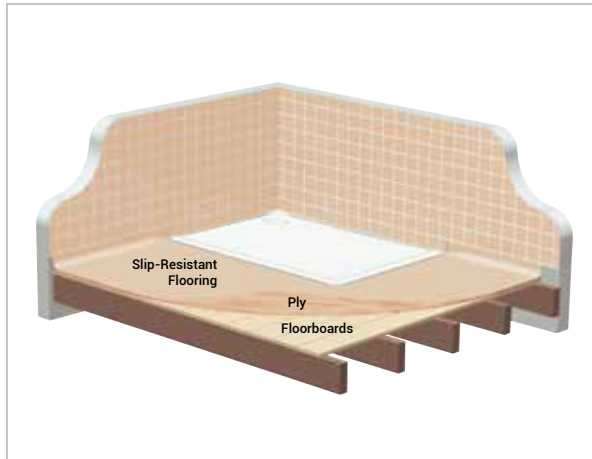

90mm Gravity Waste

- + Position waste to avoid joists (see illustration)
- + Depth below tray: 90mm



Level Access Tray

- + No ramp is needed with a screeded floor installation

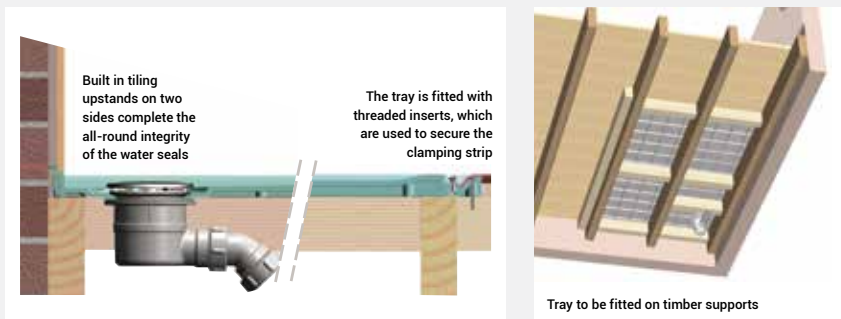

Please Note: Trays are shown in colour for illustrative purposes only.

Sulby Shower Tray: Concrete Floor Installation Guide

All AKW Sulby trays have a built-in 31mm gravity waste, set above floor level.

- + Built-in waste
- + Low level access
- + Trays need to be supported underneath on all four sides
- + No underfoam required
- + Tiling upstands provided for greater water retention and integrity

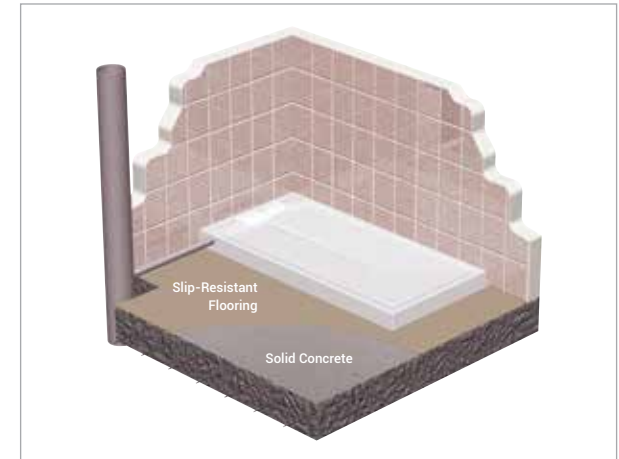

Sulby Waste Installation

- + Three different waste directions are available for easy installation
- + Adaptor gives 38mm water capacity and 35mm fall on exiting the tray
- + **Sulby Exit Heights:** 90mm Sulby Tray exit height is 60mm high at waste end 110mm Sulby Tray exit height is 80mm high at waste end

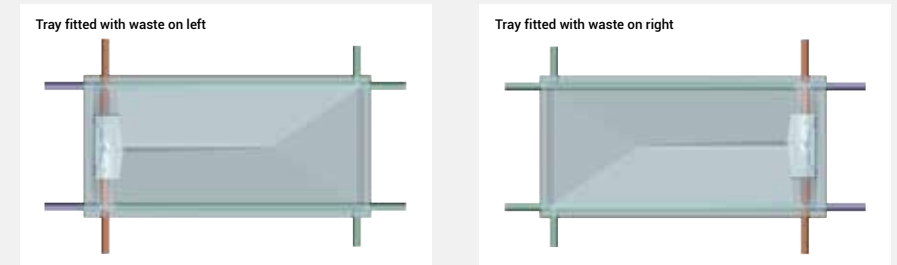
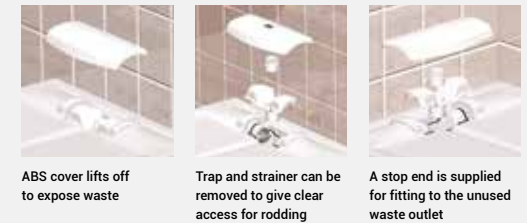



- Most direct outlet:** preferred route
- Second option:** adds one 90° elbow under the tray
- Third option:** for use if options one and two cannot be used

Sulby Shower Tray: Concrete Floor Installation Guide

Sulby 2 Waste Installation

- + Two different waste directions are available for easy installation
- + Adaptor gives 38mm water capacity and 35mm fall on exiting the tray
- + **Sulby Exit Heights:** 90mm Sulby Tray exit height is 60mm high at waste end 110mm Sulby Tray exit height is 80mm high at waste end

 **Most direct outlet:** preferred route

 **Second option:** adds one 90° elbow under the tray

Tray fitted with waste on left

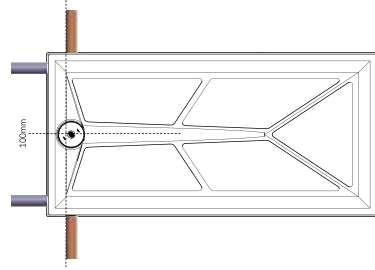

Tray fitted with waste on right

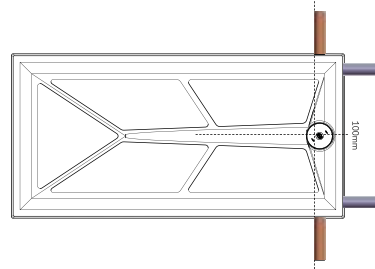

Low Profile Shower Tray: Wooden Floor Installation Guide

Low Profile trays installed for complete level access in a wooden floor. Non handed with offset waste position the tray can be rotated 180 degrees to miss the joists on two planes.

- + AKW 90mm Gravity Waste
- + Level access
- + Tray to be supported by timber supports on four sides with cross braces
- + No underfoam required

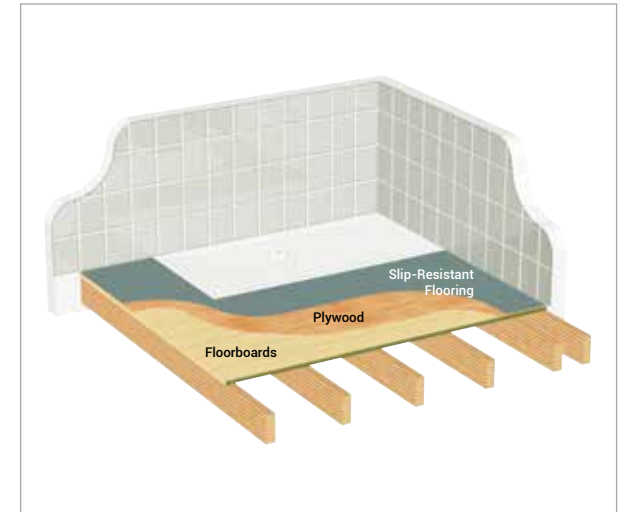

90mm Gravity Waste

- + Rotate tray to avoid floor joists. Square trays rotate in 90° increments for four waste positions (see illustration)



Level Access Tray

- + No ramp is needed with a screeded floor installation

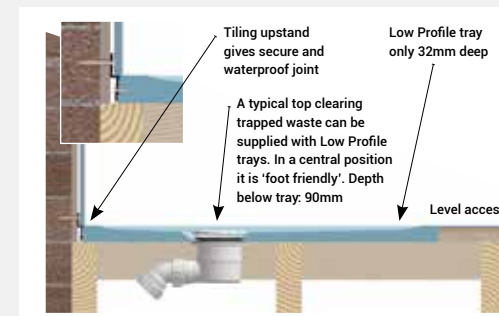

Please Note: Trays are shown in colour for illustrative purposes only. Low profile trays are not designed for use with pumped wastes.

WET ROOM FORMERS INSTALLATION GUIDES

Tuff Form® Former: Concrete Floor Installation Guide

Tuff Form® inset into screed for complete level access on a concrete floor. Features the AKW PGTF Pumped Gulley Waste.

- + PGTF Pumped Gulley Waste
- + Level access
- + Slippage or float during install is eliminated by the ribbed underside, which allows the tray to key into soft cement or screed
- + Do not dot and dab the supports

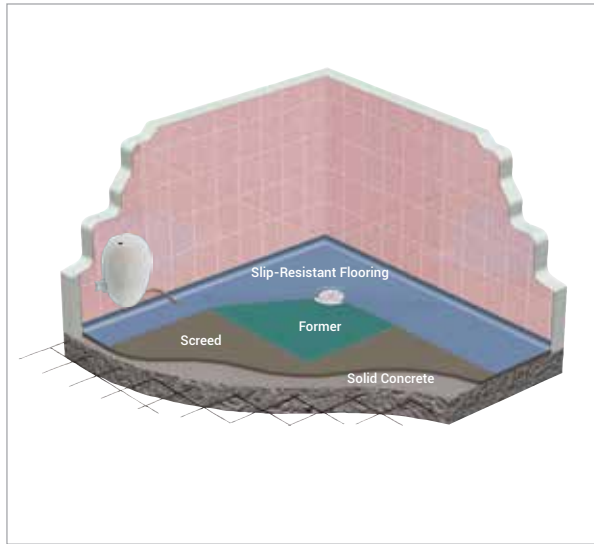

PGTF Pumped Gulley Waste

- + Opens for easy cleaning
- + Depth below tray: 43mm (15mm PGTF) or 51mm (22mm PGTF with SilentFlow+)



Level Access

- + No ramp is needed with a wet room former installation

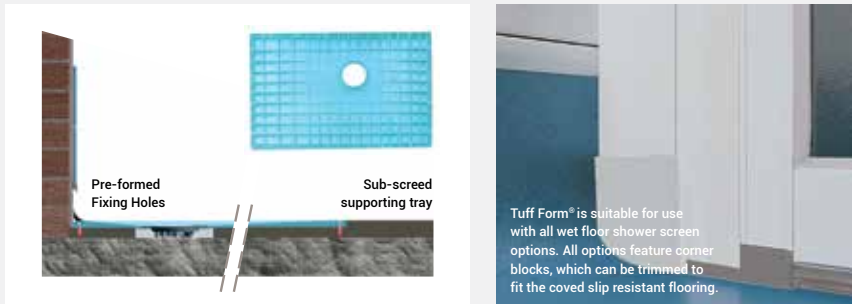

Please Note: Trays are shown in colour for illustrative purposes only.

Tuff Form® Former: Wooden Floor Installation Guide

Tuff Form® installed on wooden joists. Features the AKW TF75 Gravity Waste.

- + AKW TF75 Gravity Waste
- + Level access
- + Needs to be supported on all 4 sides at 400 / 450 centres and fully around the waste and all four sides within 120mm of centre of waste

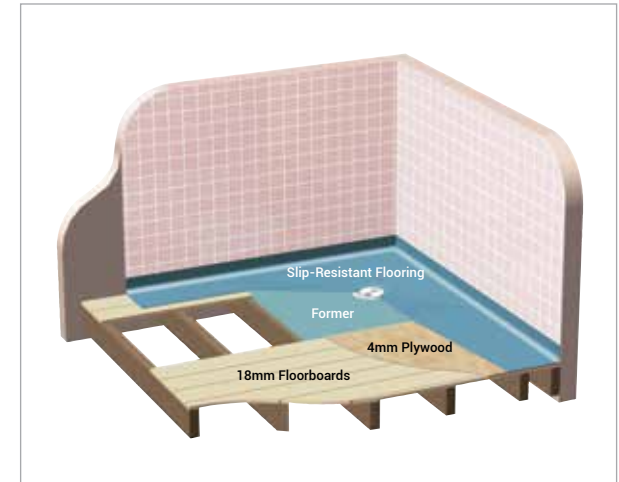

TF75 Gravity Waste

- + Opens for easy cleaning
- + Rotate former to avoid joists: avoid the wooden floor joists by rotating the Tuff Form® former by 90° or 180° (see illustration)
- + Depth below former: 125mm



Level Access

- + No ramp is needed with a wet room former installation



Please Note: Trays are shown in colour for illustrative purposes only.

Tuff Form® Former: Bathroom for Life Installation Guide

Tuff Form® offers superior strength and rigidity which can support a bath and bather. Installed with a Bath-to-Tray Adaptor this provides an easy upgrade from a conventional bathroom to a wet floor showering area when needed.

- + 75mm water trap
- + Compression pipe fitting (1 ½"/43mm to EN1455)
- + Supplied with blanking cap for use when pressure testing pipe system and also avoids collection of building residue
- + Trays need to be supported on all four sides underneath and with cross braces
- + No underfoam required

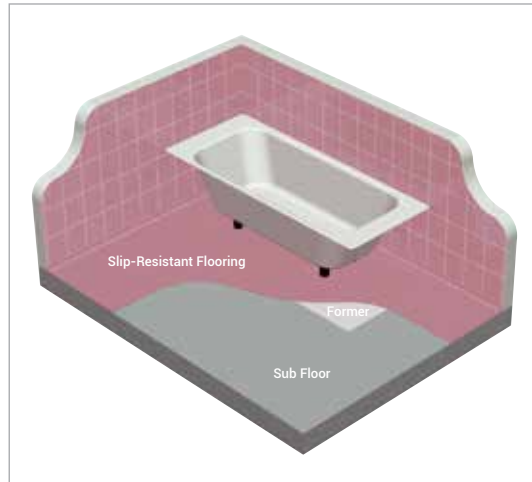

i Important: Bath-to-Tray adaptor is designed to work with TF75 wastes and Combination Wastes (Tuff Form® Waste Adaptor and GW50/GW19)

When full of water and the user, a typical 1.7m long bath can weigh up to 0.5 tonnes, creating support foot point loadings of 125kg – equivalent to 40kg per cm².

Tuff Form® can easily support 4 such point loads (totalling 500kg) provided they are at least 450mm apart and are located in a rectangular pattern.

In fact, a correctly installed Tuff Form® with edge and waste region support noggins can carry concentrated static loads in excess of 125kg, applied over an area 20mm², without difficulty.

For specialist support needs, it is possible to increase this further (up to 1 tonne). If you'd like to explore this, please get in touch with AKW's technical team.



Bath-to-Tray Adaptor (waste not included)



Bath legs can be situated directly on top of the Tuff Form®

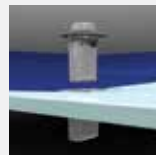

Typical waste connection (Bath to Tuff Form® and below)

Please Note: The loads stated in this example exceed the EN433 test loadings which Altro can meet for residual indentation, so this must be taken into consideration. Similarly, floor loadings which exceed BRE (Building Research Establishment) guidelines for domestic floors or Building Regulation guidelines should be reviewed by structural engineers or similarly qualified professionals. AKW can work with you to determine the best solution for specialist needs.

Not suitable for tiled floor installations.

WALL PANELS INSTALLATION GUIDE

Wall Panels Installation Guide

AKW panels are designed so that any competent tradesperson should be able to fit them. Comprehensive fitting instructions are provided with every order and can also be downloaded directly from our web site at www.akw-ltd.co.uk.

The premium range can be purchased as complete kits to ensure that you get all items required to complete your installation (excluding screws and fixings).



1: CUTTING THE PANELS

For best results the cutting action should always be into the decorative face of the panel. So when using a fine toothed handsaw, make sure the decorative side is faced upwards. When using a jigsaw or circular saw, the decorative face should be downwards. When cutting holes for valves and pipes, a minimum of 2mm clearance should be allowed all the way around. This clearance must be filled with silicone sealant.

3: FITTINGS

Shower attachments and other fittings can be secured directly to AKW panels using the appropriate fixings.

2: PREPARING THE WALLS

AKW panels can be fixed to most surfaces including concrete, chipboard and existing tiles, but it is important to ensure the walls are even and sound in order to provide the best possible fixing for them. When adhesive is to be used, clean and dry the walls to ensure the most effective bond.

Please Note: the primary fixing method used should always be mechanical, i.e. by the use of screws and rawlplugs depending on the structure of the substrate.

4: TOOLS

No specialist equipment is required, just normal woodworking tools. Such as a wood saw, screwdriver, sealant gun, spirit level, tape measure, drill, etc...

WASTE PUMP INSTALLATION GUIDES

DigiPump® Installation Guide

DigiPump® allows for precise pump control of the shower water by calculating the amount of water the shower is producing. It may be necessary to adjust the pump once installation is complete. The DigiPump® range consists of pump, flow sensor with 3m flex and water filter.

The unit must be mounted vertically, with the inlet and outlet connections at the bottom. Ensure the plumbing connections correspond to the arrow of flow indicated on the pump.

The pump is fitted with two sets of flow sensor wires, which can both be used for single flow sensors (mixer type showers require an additional flow sensor fitted to the hot water supply). Flow sensors must be mounted in the water feed to the shower.

Electrical Key

Mains Supply: 230V AC

Neutral 
Line 

From Transformer: 24V DC

Neutral 
Line 

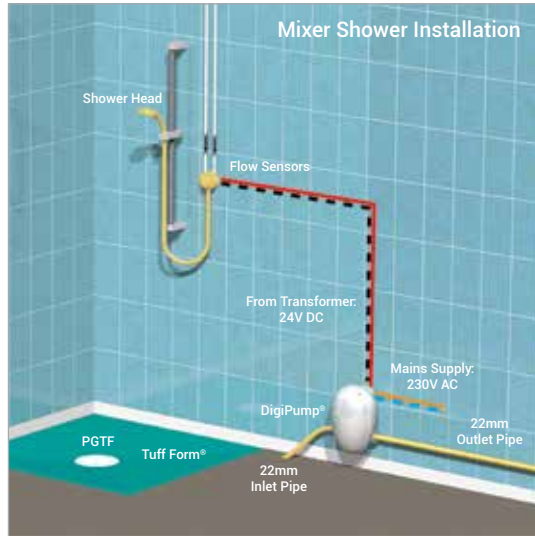

Screedmaster® Screeded Floor Installation Guide

Screedmaster® enables installers of screeded floors to fit a pumped waste into a floor screed without excavating the entire floor.

- + Level access
- + Designed to withstand the rigours of wheelchairs and chair legs
- + Fast-drying chemical cement is recommended for the in fill, so that the slip resistant flooring can be laid much sooner

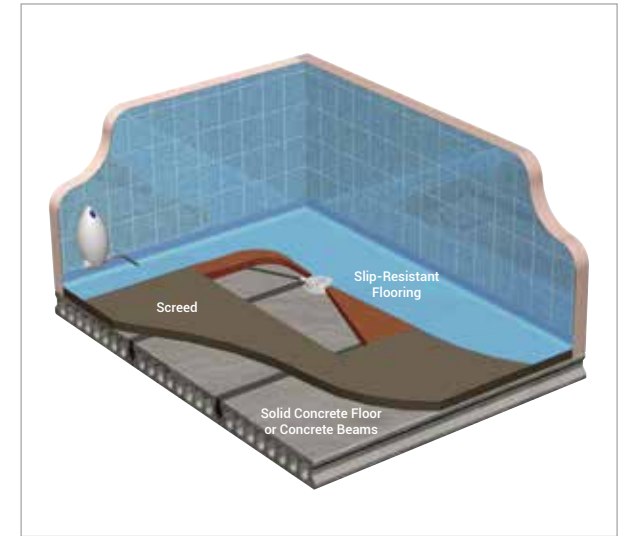

PGTF Pumped Gully Waste

- + Waste lid can be removed for easy cleaning

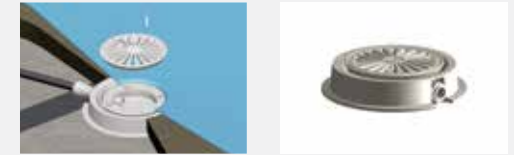

Please Note: Even with a fast-drying screed, manufacturers recommend that 21 days minimum should be allowed prior to installation of flooring.

This delay is unacceptable in most installation situations. But, failure to allow sufficient drying time for the screed could result in the vinyl floor covering separating from the screed – causing ponding, leaks and a generally uneven surface.

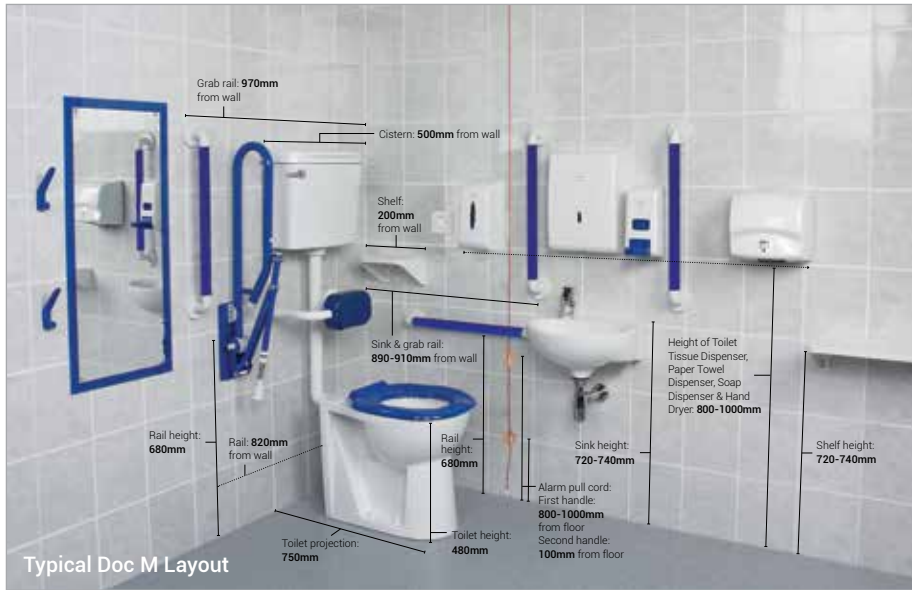

Typical Doc M Layout

It is essential that wheelchair users are able to approach, transfer to, and use the sanitary facilities provided within a building. This means a wheelchair-accessible unisex toilet must be made available.

Design Considerations

- + The arrangement should allow the user to wash and dry their hands while still seated on the WC
- + Space for manoeuvring: enable easy transfer from wheelchair to WC, whether the user is alone or assisted
- + Flat-topped close-coupled cistern, providing a back rest and a colostomy changing surface for standing users
- + Where high low or level cisterns are used, a rail with a padded back rest and a separate colostomy changing shelf (125-150mm deep and preferably 400mm wide), 950mm above floor level, should be provided

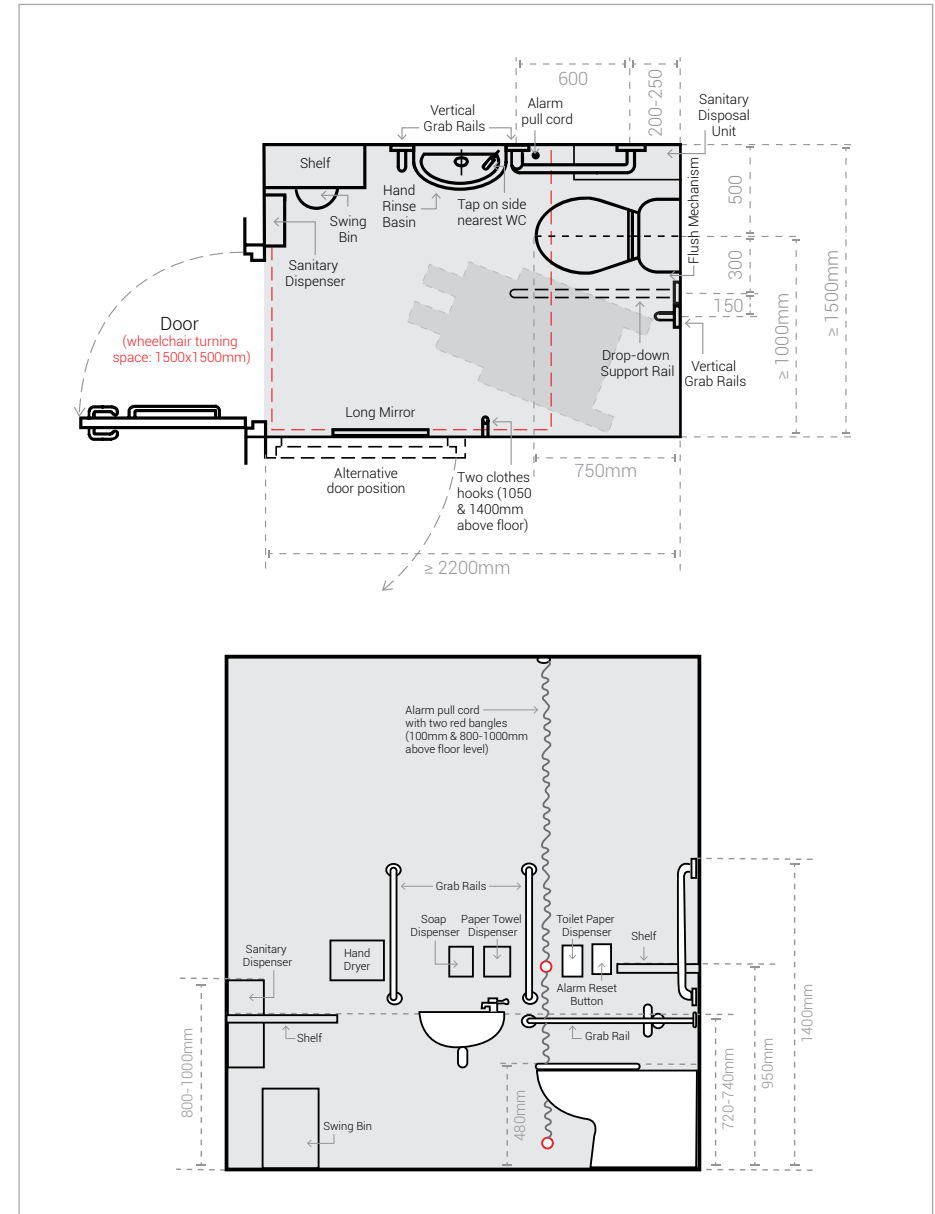

Useful Information

This section contains all the important information suppliers should provide to their customers.



Product Index

WET ROOMS	19	Showers	180
Wet Room Formers	20	Electric Showers	181
Tuff Form®	21	AKW SmartCare Plus	181
TriForm®	26	iTherm	184
Wastes	30	Mira	186
Gravity Wastes	31	Triton	187
Dry Wastes	35	Mixer Showers	188
Waste Adaptors	40	Arka	188
Tanking Kits & Accessories	42	Vettora	191
Mapei Tanking Kits	43	WALLS AND FLOORS	193
FormSafe® Kit	44	Tiles & Accessories	194
Threshold Kits	45	Super White Bumpy Tiles	195
TRAYS AND SHOWERING	47	Tile Edge Trim & Strips	195
Shower Trays	48	Tile Spacers	196
Braddan Trays	49	Tile Grout	196
Sulby Trays	57	Tile Adhesive	196
Mullen® Trays	65	Timber	198
Low Profile Trays	72	CLS Timber 3"x2"	199
Onyx Low Level Shower Tray	76	Plywood FSC Certified	199
Shower Screens & Enclosures	78	Safety Flooring	200
Larenco Screens	79	Safety Flooring	200
Level Best Glass Screens	95	Accessories	202
Standard Screens	97	Wall Panels	204
Standard Wet Floor Screens	119	Premium Wall Panels	207
Silverdale® Screens	132	Trade Range Wall Panels	205
Silverdale® Wet Floor Screens	143	MOBILITY SUPPORT	209
Sliding Screens	147	Grab Rails	210
Made-to-Measure Screens	154	Heavy Duty Grab Rails	211
Standalone Cubicles	159	Plastic Grab Rails	213
Showerloo Cubicles	162	Steel Grab Rails	217
Accessories	163	T-Shaped Grab Rails	220
Portable Screens	163	Hand Rails	220
Shower Curtain Rails	164	Floor-to-Ceiling Support Poles	221
Shower Curtains	168	Fold-Up Rails	222
Shower Screen Handles	169	Wastes & Pumps	170
Gravity Wastes	171	Gravity Wastes	171
Pumped Wastes	176	Digital Waste Pumps	177
Digital Waste Pumps	177	AKW DigiPump SmartCare	179
AKW DigiPump SmartCare	179		

Shower Seats	226
Fold-Up Shower Seats	227
4000 Series Shower Seats	227
3000 Series Shower Seats	236
2000 Series Shower Seats	237
1000 Series Shower Seats	240
Bama Fold-up Shower Seats	242
Hanging Shower Seats	243
Freestanding Shower Seats	244
Wooden Shower Seats	245
Doc M	246
Doc M Packs	247
Doc M Washroom Products	251
Mobility Ramps	256
Folding Access Ramps	257
Threshold Ramps	258
WASHROOM PRODUCTS	261
Sanitaryware	262
Toilets	263
Doc M Toilet Pans	264
Floor Mounted Toilet Pans	266
Wall Hung Toilet Pans	270
Geberit AquaClean	273
Toilet Accessories	275
Body Dryers	276
Wash Basins	277
Brassware	282
Wash Basin Taps	283
Taps (pair)	283
Mixer Taps	283
Brassware Accessories	285
Safety Heating	286
Towel Warmers	287
Underfloor Heating	288
Lights & Extractor Fans	290
Bathroom Lights	291
Extractor Fans	295

BATHROOM FURNITURE 297

Furniture	298
Basin Units	299
WC Units	300
Base Units	302
Countertops	303
Integrated Sanitaryware	304
Accessories	305
Handles	305
Optional dual flush plate	305
Plinths/Infill panels	305

PLUMBING FITTINGS 307

Plumbing Fittings	308
Compression Fittings	309
End Feed	310
Flexi Hoses	312
Isolating Valves	313
Push Fit	314
Solvent Weld	317

KITCHENS 321

ActivMotion®	322
ActivMotion® Worktops	323
ActivMotion® Cupboards	324
Independence Kitchen	326
Unit Options	327
Tall Units	327
Wall Units	330
Base Units	334
Bridging Units	339
Trolley Units	341
Corner Carousel Units	342
Door Colour Options	343
Liberty Kitchen	344
Unit Options	345
Tall Units	345
Wall Units	346
Base Units	347
Accessories	349
Panels, Plinths & Fixtures	349
Door Colour Options	353

Kitchen Options 354

Door Handles	355
Worktops	357
Appliances	358
Ovens	358
Hobs	360
Extractor Hoods	362
Sinks	364
Taps	367

SUPPORT 369

Installation & Product Guides	370
Choosing The Right Product	371
Shower Trays Installation	372
Braddan	372
Mullen®	375
Sulby	377
Low Profile	379
Wet Room Formers Installation	380
Tuff Form®	380
Wall Panels Installation	383
Waste Pumps Installation	384
DigiPump	384
Screedmaster	385
Doc M Installation	386
Useful Information	388
Product Index	389
Visit AKW	393
General Information	394
Product Information	394
Legal Information	395
Terms & Conditions	396



Visit AKW

**AKW Medi-Care Ltd
Sales, Marketing & Distribution Centre**
Liberty House,
Pointon Way,
Hampton Lovett,
Droitwich Spa,
WR9 0LR

**AKW Medi-Care Ltd
Showroom & Head Office**
Independence House,
Pointon Way,
Hampton Lovett,
Droitwich Spa,
WR9 0LW

You can collect your order same day from our Trade Counter, at Independence House, with AKW's free click & collect service.

Open Monday to Friday, from 8am to 5.30pm (last orders 4pm).

From the North: Leave the M5 at Junction 5 (A38 Droitwich). At the roundabout, take the 4th exit onto the A38. At the next roundabout, take the 1st exit onto the A38.

Continue on the A38, entering Droitwich. At the next roundabout, take the 4th exit onto Kidderminster Road (A442).

At the Stonebridge Cross roundabout, take the 1st exit onto Pointon Way (Stonebridge Cross Industrial Estate).

The first building on your left is the AKW Head Office and Showroom. For Sales, Marketing & Distribution continue on Pointon Way. At the roundabout, take the 1st left into AKW Liberty House.

From the South: Leave the M5 at Junction 6 (Worcester (N)). At the roundabout, take the 3rd exit onto the A4538. Continue on the A4538, entering Martin Hussingtree. At the traffic signals, turn right onto the A38 (Droitwich).

Continue on the A38, entering Droitwich. At the next roundabout, take the 2nd exit onto Kidderminster Road (A442).

At the Stonebridge Cross roundabout, take the 1st exit onto Pointon Way (Stonebridge Cross Industrial Estate).

The first building on your left is the AKW Head Office and Showroom. For Sales, Marketing & Distribution continue on Pointon Way. At the roundabout, take the 1st left into AKW Liberty House.

General Product Information

Cleaning Instructions

To help maintain long-life, you should periodically clean all AKW and Mobility support products.

Use normal domestic bathroom cleaning materials, and avoid any strong or concentrated acidic, alkaline or other cleaning materials. These may discolour or otherwise damage the products.

After cleaning, always rinse with water and wipe thoroughly with a damp cloth to remove any cleaning material residues.

Installation Instructions

AKW products should be installed by an experienced and competent person.

Fixings should be appropriate to the maximum rated user load, and selected to suit the condition of the surfaces to which it is being attached.

The selection of any specific fixings should be made by the installer based upon the requirements for each individual installation.

Power Showers/ High Flow Systems

AKW trays and screens are not suitable for use with power showers or high flow systems.

We recommend that you should use only AKW screens with AKW trays. These products have been designed and manufactured to be used together. Their use with non AKW products may adversely affect the integrity of the water seal between the tray and screen.

Most of our products are kept in stock, a few items are not immediately available and will need to be ordered. Please contact our Customer Services Team on 01905 823299 for more information.

Legal Information

For all technical information please refer to the installation instructions, available as a hard copy on request or online at www.akw-ltd.co.uk

The format, layout and organisation of this catalogue and all images herein are the property and copyright of AKW Ltd and may not be reproduced. AKW has a policy of continuous product improvement and reserves the right to change products, specifications and dimensions without prior notice. Copyright ©2018 AKW Medi-Care Ltd. All rights reserved. This publication and any part thereof may not be reproduced, stored in a retrieval system or transmitted in any form or by any means, electronic, mechanical, photocopying, scanning or otherwise, without prior written permission. Speedfit® is the registered trademark of John Guest International Limited.

Some AKW products featured in the product literature are protected by one or more of the following U.K., U.S. or foreign patents and other pending patent applications and/or registered design or other pending design applications: GB2426194, GB2374876, GB2375479, GB2401341, GB2406270, GB2394175, GB2402946, GB2410426, EP1523914, GB205802, GB3021810, GB3020282, GB3021505, GB3016631, GB3020208, GB3023907, EU000627146-0001, EU000566849-0001, EU000343561-0001, EU000379524-0001, EU000415765-0001, EU000717541-0001/2/3/4/5, EU000694781-0001, EU000189105-0001, EU000448535-0001, EU000692249-0001, USD539394, USD36889, USD510487, USD501611, USD494767, US 6725470, US 6890427, GB3008313, GB3008314, GB3011017, GB3011018, GB3011016, GB2058001, GB2058002, EU000024591-0001/2, EU000062047-0001/2, EU000135702-0001/2/3/4/5/6/7/8/9, GB2394175, GB2306316, GB2313306, GB2315211, GB2322546, GB2373515, GB2375479, GB2359484, GB2369568, GB2372267, GB3020282, GB2490442, EU2087823, US8370982, US8286279, GB2481813, GB2560278.

AKW does not hesitate to undertake rigorous protection, defence and maintenance of its intellectual property assets world-wide. Unregistered design rights exist wherever permissible. All dimensions given in this brochure are approximate and subject to manufacturing tolerances. AKW Medi-Care Ltd makes no warranty, expressed or implied, or accepts any liability in connection with this information or its use. This information is furnished upon the condition that the person receiving it shall make their own tests to determine the suitability thereof for their particular purpose. The AKW device is a registered trademark of AKW Medi-Care Ltd.

"AKW", "AKW SmartCare Plus", "Archimedes", "Arka", "DigiPump", "Intergrip", "Level Best", "Luda", "Luda Twist", "Mullen", "Screedmaster", "Silverdale", "Tuff Form", "Trays Direct", "Universal", "ActivMotion", "AKW Liberty", "Javina", "Saphini", "Turico", "TriForm", "Triforce", "Silentflow+", "AKW Delivering Independence", "AKW Denova", "AKW Medicare", "iSure", "Livenza", "Larenco" and "FormSafe" are all registered trademarks.

We operate a constant improvement policy and our products are subject to change without notice.

AKW endeavour to provide literature that is correct at the time of printing. However we reserve the right to change product specifications, pricing and other information without notice. AKW take no responsibility for printing errors.

Copyright ©2019 AKW Medi-Care Ltd. All rights expressly reserved.

Terms & Conditions

1. DEFINITIONS

1.1 The "Company" means AKW Medi-Care Limited.

1.2 The "Customer" means any person, firm or company purchasing the Goods.

1.3 The "Contract" means the contract between the Company and the Customer for the sale and purchase of the Goods, comprising the quotation (if any) made by the Company, the Customer's order for the Goods, the Company's acceptance thereof and these terms and conditions.

1.4 "Credit Reference Agencies" means Experian Limited and/or any other organisation that maintains and provides information concerning the credit history of any person.

1.5 "Data Subjects" means (1) the Customer, (2) where the Customer is a company, the directors of that company, (3) where the Customer is a partnership, the partners of that partnership, (4) where the Customer is a limited liability partnership, the members of that limited liability partnership and (5) where the Customer is a business conducted by an individual, that individual.

1.6 The "Goods" means any goods or services agreed in the Contract to be supplied to the Customer by the Company (including any part of parts of them).

1.7 "Group Company" means the Company and any holding company of the Company from time to time and any subsidiary from time to time of any such holding company.

2. PREVAILING TERMS & CONDITIONS

2.1 The Company is only willing to contract on these terms and conditions and any printed or standard conditions which appear or are referred to on any document emanating from the Customer or any variations from the Company's standard terms and conditions are to have no legal effect unless agreed in writing by a director of the Company.

2.2 The Customer acknowledges that it has not relied on any statement, promise or representation made or given by or on behalf of the Company which is not set out in the Contract. Nothing in this condition shall exclude or limit the Company's liability for fraudulent misrepresentation.

3. FORMATION OF CONTRACT

3.1 Any quotation is given on the basis that no Contract will come into existence until the Customer's order is accepted by the Company delivering a written or electronic acknowledgement of order to the Customer. If the Customer's order is not preceded by a quotation from the Company, the Customer's order shall not become binding on the Company until it is accepted by the Company delivering a written or electronic acknowledgement of order to the Customer.

4. QUOTATIONS, PRICING AND ORDERS

4.1 All prices quoted are exclusive of VAT, which will be added to the price at the prevailing rate. The quoted price may be varied by the Company in accordance with cost variations but will not result in any right by the Customer

to cancel the contract. Carriage may be charged extra in accordance with rates as published in current AKW and/or Trays Direct price lists.

4.2 The Company reserves the right to alter carriage charges without notice in the event of fuel surcharges being imposed by our carriers. Small consignments may include a small order charge as published in current AKW and/or Trays Direct price lists.

4.3 Any costs incurred by ourselves as a result of cancellation of bespoke items will be chargeable.

5. DELIVERY

5.1 Delivery is free of charge using our standard delivery service. Effective 1st January 2014 our next working day delivery service is subject to a minimum order value of £275. Orders below this value are subject to a charge of £12.00.

5.2 Unless otherwise agreed in writing, delivery of the Goods shall take place at the Company's place of business.

5.3 Please do not schedule or start any installation work until after you have received your order and checked all goods for any defects or missing parts. This will enable you to resolve any technical questions or to order specific additional fittings if needed.

5.4 Any quotation by the Company of a time for delivery is not guaranteed and time for delivery shall not be made of the essence by notice.

5.5 No liability is accepted for direct, indirect or consequential loss (all three of which terms include, without limitation, pure economic loss, loss of profits, loss of business, depletion of goodwill and similar loss), costs, damages, charges or expenses caused directly or indirectly by any delay in the delivery of the Goods (even if caused by the Company's negligence). Nor shall any delay entitle the Customer to terminate or rescind the Contract unless such delay exceeds [180] days.

5.6 The quantity of any consignment of Goods as recorded by the Company on despatch from the Company's place of business shall be conclusive evidence of the quantity received by the Customer on delivery unless the Customer can provide conclusive evidence proving the contrary.

5.7 The Company shall not be liable for any non-delivery of Goods (even if caused by the Company's negligence) unless the Customer gives written notice to the Company of the non-delivery within 3 days of the date when the Goods would in the ordinary course of events have been received.

5.8 Any liability of the Company for non-delivery of the Goods shall be limited to replacing the Goods within a reasonable time or issuing a credit note at the pro rata Contract rate against any invoice raised for such Goods.

5.9 No claim for damage to the Goods or shortages in the Goods will be considered unless the Company is advised within 3 days of delivery and the Customer also notifies the carrier in the manner and within the appropriate time limit prescribed by the carrier's terms and conditions.

5.10 If for any reason the Customer fails to accept delivery of any of the Goods when they are ready for delivery, or the Company is unable to deliver the Goods on time because the Customer has not provided appropriate instructions, documents, licences or authorisations: (a) risk in the Goods shall pass to the Customer (including for loss or damage caused by the Company's negligence); (b) the Goods shall be deemed to have been delivered; and (c) the Company may store the Goods until delivery, whereupon the Customer shall be liable for all related costs and expenses (including, without limitation, storage and insurance).

6. PAYMENT TERMS

6.1 Payment terms are strictly 30 days after date of invoice. The Company reserves the right to charge interest at the rate of 4% over Lloyds Bank base rate on all overdue accounts. The due date for payment is of the essence of the contract. The Customer will have no right to set-off statutory or otherwise.

7. PROPERTY AND RISK

7.1 The property (both legal and equitable) in the Goods shall not pass to the Customer until: (a) the purchase price of the Goods has been paid in full, and (b) payment is made to the Company of any sum which is at the date of the Contract or may thereafter become due or owing from the Customer to the Company.

7.2 Until property in the Goods has passed to the Customer the Customer will hold the Goods (or their proceeds of resale) in a fiduciary capacity.

7.3 Notwithstanding that the ownership remains with the Company until Goods are paid for in full, the Customer shall accept the risk in the Goods on delivery and shall appropriately insure them.

7.4 Until property in the Goods has passed to the Customer, the Customer shall keep the Goods separately identifiable and shall not destroy, deface or obscure any identifying mark or packaging on or relating to the Goods.

7.5 The Customer grants an irrevocable licence to the Company to enter on to the Customer's premises with agents and vehicles if appropriate to recover the Goods.

7.6 The Customer's right to possession of the Goods shall terminate immediately if: (a) the Customer has a bankruptcy order made against him or makes an arrangement or composition with his creditors, or otherwise takes the benefit of any statutory provision for the time being in force for the relief of insolvent debtors, or (being a body corporate) convenes a meeting of creditors (whether formal or informal), or enters into liquidation (whether voluntary or compulsory) except a solvent voluntary liquidation for the purpose only of reconstruction or amalgamation, or has a receiver and/or manager, administrator or administrative receiver appointed of its undertaking or any part thereof, or documents are filed with the court for the appointment of an administrator of the Customer or notice of intention to appoint an administrator is given by the Customer or its directors or by a qualifying floating charge holder (as defined

in paragraph 14 of Schedule B1 to the Insolvency Act 1986), or a resolution is passed or a petition presented to any court for the winding-up of the Customer or for the granting of an administration order in respect of the Customer, or any proceedings are commenced relating to the insolvency or possible insolvency of the Customer; or (b) the Customer suffers or allows any execution, whether legal or equitable, to be levied on his/its property or obtained against him/it, or fails to observe or perform any of his/its obligations under the Contract or any other contract between the Company and the Customer, or is unable to pay its debts within the meaning of section 123 of the Insolvency Act 1986 or the Customer ceases to trade; or (c) the Customer encumbers or in any way charges any of the Goods.

7.7 the Company shall be entitled to recover payment for the Goods notwithstanding that ownership of any of the Goods has not passed from the Company.

8. GUARANTEE AND EXCLUSIONS

8.1 All catalogue products are guaranteed for life apart from where it indicates otherwise. The Company will free of charge repair or at its option replace any Goods which are proved to its reasonable satisfaction to have failed to meet its designed specification due to defective material or workmanship, provided that this obligation shall not apply where: (a) the Goods have been improperly installed, installed with a defect without the written authority of the Company, altered in any way or are subject to any unauthorised repair or misuse, or (b) the Customer has failed to provide documentary notification and proof of a defect or suspected defect or returned the goods for inspection within 14 days of the same coming to the knowledge of the Customer, or (c) the Customer is in breach of this or any other contract with the Company.

8.2 Save as provided in the preceding paragraph in no circumstances will the company or its employees, agents or sub-contractors be liable for any loss or damage of any kind consequential or otherwise (other than death or personal injury resulting from the company's negligence) whether under the contract or not, or caused directly or indirectly by any negligence or other tortious act or breach of statutory duty on the part of the company or on the part of any of its employees, agents or sub-contractors in connection with or arising out of the manufacture or supply of the goods or in connection with any statement given or made (or advice not given or made) by or on behalf of the company. The company hereby excludes all conditions, warranties and stipulations express or implied, statutory, customary or otherwise which but for such exclusion would or might subsist in favour of the customer.

Terms & Conditions (continued)

9. RETURNS

9.1 The Company disclaims liability for goods returned without the written authority of the Company. Any goods approved for return must be advised in writing quoting the Company's invoice number and returns number. The Company disclaims any risk or liability for any returns whilst in transit to the Company. If for any reason you are unhappy with your goods please notify AKW Medicare and return within 30 days. All returns must be in the original packaging. Only items printed on the returns form are authorised for return. We reserve the right to return any non-authorised items to you.

Please also remember to check goods ensuring you are happy with them before signing. There is a £32 collection charge for returns. We reserve the right to deduct repackaging or restocking fees (where applicable) from any credit/refund amount, or apply charges direct to your account. If a return is made using a third-party carrier proof of postage must be retained. AKW reserve the right to not credit an account if proof of postage cannot be provided. AKW reserve the right to charge £32 per attempted collection. The following are excluded from our returns policy:- Made-to-measure products, Independence kitchen units and special order products.

10. RIGHT TO SUB-CONTRACT OR ASSIGN

10.1 The Company shall be entitled to sub-contract or assign any part of the Contract to any person, firm or Company.

10.2 The Customer shall not be entitled to assign the Contract or any part of it without the prior written consent of the Company.

11. FORCE MAJEURE

11.1 If the Company is prevented or hindered from making delivery of any Goods or completion of any work by reason of acts of God, civil disturbance, industrial action (including labour disputes involving the work force or any part of the work force of the Company), government action or any other cause whatever beyond the Company's control, the Company may give notice to the Customer either: (a) cancelling the Company's outstanding obligations under the Contract, or (b) extending the time for delivery or completion by a period not exceeding four months.

12. TERMINATION

12.1 The Contract will terminate immediately upon service of written notice of termination by the Company on the Customer on the happening of any one or more of the following: namely, that the Customer has suffered or allowed any execution whether legal or equitable to be levied on their property or obtained against them or has failed to observe or perform any of their obligations or duties under the Contract or any other contract between the Company and the Customer or is unable to pay their debts within the meaning of Section 123 of the Insolvency Act 1986 or the Customer has ceased to trade.

13. GENERAL

13.1 Each right or remedy of the Company under the Contract is without prejudice to any other right or remedy of the Company whether under the Contract or not.

13.2 If any provision of the Contract is found by any court, tribunal or administrative body of competent jurisdiction to be wholly or partly illegal, invalid, void, voidable, unenforceable or unreasonable it shall to the extent of such illegality, invalidity, voidness, voidability, unenforceability or unreasonableness be deemed severable and the remaining provisions of the Contract and the remainder of such provision shall continue in full force and effect.

13.3 Failure or delay by the Company in enforcing or partially enforcing any provision of the Contract shall not be construed as a waiver of any of its rights under the Contract.

13.4 Any waiver by the Company of any breach of, or any default under, any provision of the Contract by the Customer shall not be deemed a waiver of any subsequent breach or default and shall in no way affect the other terms of the Contract.

13.5 The parties to the Contract do not intend that any term of the Contract shall be enforceable by virtue of the Contracts (Rights of Third Parties) Act 1999 by any person that is not a party to it.

14. PROPER LAW

14.1 The Customer and the Company agree that the proper law governing any contract between them will be English law and agree to submit to the non-exclusive jurisdiction of the English Courts.

14.2 Irrespective of any suggestions and guidance given by the Company in its literature or otherwise it is the Customer's responsibility to ensure the installation complies with all regulations and requirements that apply to the Customer's site.

14.3 Due to a continual policy of product development the Company reserves the right to amend specifications where necessary.

15. DATA PROTECTION

15.1 To help the Company decide whether to enter into a Contract and to help the Company manage the Customer's account, the Company may search any of the following records, namely the Data Subjects' personal and business records at Credit Reference Agencies, the Company's own records and those of any Group Company concerning Data Subjects and Data Subjects' records at UK or overseas fraud prevention agencies. A record of the Company's searches will be made and this will be available to other organisations who make similar searches. Credit Reference Agencies may supply to the Company both public (including electoral register) and shared credit and fraud prevention information. The Company may also use information it obtains from the Customer's performance of any other agreement or contract it has or has had with any Group Company. The Company may also use identity verification, credit scoring or other automated decision-making systems.

15.2 The Company will add to the Data Subjects' records with the Credit Reference Agencies by giving information relating to the Data Subjects, the Contract and information about the Customer's payment record. The Company will also tell them of any delay or default in payment or otherwise and any change of address the Customer fails to notify to the Company when any payment is overdue. It is important that Data Subjects supply accurate information to the Company. The Company may check Data Subjects' details with fraud prevention agencies and if the Company is given false or inaccurate information or the Company suspects fraud, it will record this and may pass on this information to fraud prevention agencies and other organisations involved in crime and fraud prevention.

Credit Reference Agencies and fraud prevention agencies may record any information supplied to them by the Company. Records remain on file for six years or other period permitted by applicable law.

15.3 This information may be supplied to, shared with and cross checked by other UK or overseas businesses and organisations (including any Group Company, lenders, Credit Reference Agencies, fraud prevention agencies, credit industry fraud avoidance networks and any other company that the Company may select from time to time):

15.3.1 to assess applications for credit and relate services made by Data Subjects;

15.3.2 to trace debtors, recover debt, to prevent fraud and money laundering;

15.3.3 to make decisions about a Data Subject's account;

15.3.4 to carry out statistical analysis and market research;

15.3.5 for such other purposes required or permitted by law, including the General Data Protection Regulation (GDPR).

15.4 The Company may also give information about Data Subjects to:

15.4.1 the Company's insurer;

15.4.2 anyone acting on the Company's behalf, including a Group Company;

15.4.3 any finance house;

15.4.4 companies or other bodies which maintain registers of assets and interests in them; and

15.4.5 credit industry fraud avoidance networks for the purpose of administration, underwriting and processing.

15.5 The identities of the Credit Reference Agencies and the ways in which they use and share personal information are explained in more detail at <http://www.experian.co.uk/crain/index.html>.

15.6 Fraud prevention agency records will also be shared with other organisations to help make decisions on credit proposals for Data Subjects. For these purposes the Company or they may make further searches.

15.7 Information held about Data Subjects by the Credit Reference Agencies may already be linked to records relating to one or more of their partners. For the purposes of the Contract, Data Subjects may be treated as financially linked and the Customer's application will be assessed

with reference to any associated records. If the Customer is a joint applicant or a Data Subject has told the Company of some other financial association with another person, the Customer and applicable Data Subjects must be sure that they are entitled to disclose information about the applicable joint applicant and anyone referred to by them and authorise the Company to search, link or record information at Credit Reference Agencies about them and anyone referred to by them. An "association" between joint applicants and between applicants and anyone referred to by them a financial partner will be created at Credit Reference Agencies. This will link the financial records of applicants and all such persons, each of which will be taken into account in all future applications by any of the applicants and all such persons. This will continue until one of them successfully files a disassociation at the Credit Reference Agencies.

15.8 If a customer has obtained credit from the company and does not make payment when due, the company will trace the customers whereabouts and recover debts.

15.9 The Company may contact Data Subjects from time to time with details of other products and services which it or third parties offer. Any such contact will be aligned with the requirements of the General Data Protection Regulation (GDPR), and Data Subjects will have the option to opt-out of this type of contact. For this purpose, the Company may make use of an automated decision making programme now and in the future. It may also share information about Data Subjects to any Group Company. The Company will never sell your Personal Data to any third parties. Data Subjects may be contacted by post, telephone, or other means.

Data Subjects have a legal right to stop the Company from contacting them or giving their details to others for direct marketing purposes. Please write to the Company at our address at AKW Medi-Care Limited, Unit 404 Pointon Way, Hampton Lovett, Droitwich Spa, Worcestershire WR9 0LR if you wish to exercise this right.

15.10 Data Subjects have several legal rights with regard to the Personal Data the Company holds about them. These rights granted under the General Data Protection Regulation (GDPR) include the right to be informed, the right of access, the right to rectification, the right to erasure, the right to restrict processing, the right to data portability, the right to object and rights in relation to the use of automated data profiling or decision making systems. The Company has procedures in place to uphold these rights, and fulfil and related requests within thirty days from acknowledgement. Further details can be found in our Privacy Notice or you may contact gdp@akw-ltd.co.uk.

15.11 By agreeing to these terms and conditions, Data Subjects accept that the Company may use information concerning them in the way described above. The Company will take steps to ensure Personal Data is collected fairly, used for the purposes stated, stored securely and only retained for suitable periods.

Orders & Quotes

01905 823 299

orders@akw-ltd.co.uk

AKW[®]
Life Made Better

General Enquiries

01905 823 298

sales@akw-ltd.co.uk

Technical Enquiries

01905 560 219

technicalenquiries@akw-ltd.co.uk

Kitchen Enquiries

01905 823 262

kitchens@akw-ltd.co.uk

Fax

01905 823 297

AKW

Pointon Way, Hampton Lovett

Droitwich Spa, WR9 0LR

www.akw-ltd.co.uk

orders.akw-ltd.co.uk

