

acquabella

GENERAL CATALOGUE **EN**

acquabella.com

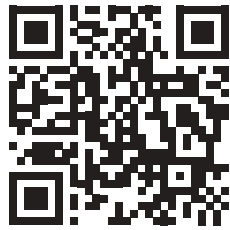



Iconography



Akron material



Bespoke cut



Base/Arq Stainless grid included



Areia Akron cover included



Flow Akron cover included



Chrome overflow included



Easy access



Dolotek material



Trap included
(Base / Arq / Unic / Areia / Natur / Smart / Focus)



Base/Arq Akron grid included
(3 models available)



Natur Akron grid included



Focus Akron grid included



Trap included
(Opal Quiz / Lech / Dewa / Voss / Chrea / Levi / Vars / Venet / Boreal)



Lightweight material



Content

<i>Company</i>	4-9
<i>Akron</i>	10-11
<i>Textures and colours</i>	12-17
<i>Dolotek</i>	18-19
<i>Shower trays</i>	20-141
<i>Bathtubs</i>	142-187
<i>Wallpanels</i>	188-209
<i>Worktops</i>	210-243
<i>Basins</i>	244-271
<i>Totems</i>	272-285
<i>Furniture and accessories</i>	286-323
<i>Technical information</i>	324-344



CLASS C
UNE-ENV 16165:2022 Annex A
** Beton / Slate / Slate Evo / Arabba / Wave / Zero*



Trap included
(Halo / Tempo / Flow)



Unic Akron grid included
(3 models available)



Smart Akron grid included



Prisma Stainless grid included



Trap included
(Nevis)



Stock: shipping in 48h after the order



Maximum and minimum thickness



Trap included
(Prisma)



Halo Akron cover included



Tempo Akron cover included



Integrated overflow



Adjustable legs included

Haute couture for your bathroom

We will bring your ideas to life with innovative, tailor-made bathroom solutions to create your wellness space. Innovation and sustainability are our guiding lights, but we never lose sight of what matters most: people and their trust in our team.



Who we are



Professionalism

Our approach is rigorous, precise and reliable, implemented by a team who are deeply committed to their work.



Quality

We have a responsible attitude to product quality and customer service and have ISO 9001 certification.



Creativity

Innovation feeds us. Thanks to the team's active listening and capacity for innovation, we are able to create products that meet customers' needs.



Continuous improvement

We improve our relationships and our products and services every day in a continuous pursuit of excellence.



Teamwork

Our work is based on respect and collaboration, bringing together diverse perspectives and allowing everyone to do their best work.

We design unique experiences

We create sensations. Through design, texture and colour we take the shower experience to another level. At Acquabella we have a distinctive identity that is reflected in all our products and public activity. The perfect combination of the most advanced technology and craftsmanship offers maximum attention to detail to create spaces that meet the needs of each customer or project.



Materials of certified quality

Products manufactured with durable and easy to maintain materials that will withstand wear and tear.



Adaptability

We bring your ideas to life because we can manufacture in the dimensions you need in a wide range of formats and will gladly personalise our products.



3D Library

We make your projects a reality using technology. Discover our 3D library and design your own bathroom.





Committed to sustainable development

At Acquabella we realise that we have responsibilities towards the environment and wider society. That is why the business has taken on the UN's Sustainable Development Goals (SDGs) as its own goals. In that respect, we are committed to measuring our environmental impact and taking steps that contribute towards sustainable growth.



Innovation to transform the future

We want to generate unique experiences of comfort, design and safety. As we develop, we want to work with the most sustainable technology, with a firm commitment to quality and respecting the needs of all the people that make up our business and our immediate environment. That conviction has earned us internationally recognised certifications.



9001:2015
Quality Management System



14001:2015
Environmental Management System



45001:2018
Occupational health and safety management System

Scan the code if you want to know our ESG actions



Akron

Akron is a next-gen material composed of polyurethane and high-quality mineral of varying sizes compacted to achieve a solid, strong result. The surface is treated with an acrylic polyurethane coating that fully bonds with the underlying material. Akron's advanced formulation allows us to create products with high-definition textures, in bold shapes and a wide variety of colours for products with extraordinary design and high technical performance. Akron was also developed in an efficient and environmentally friendly way. A before and after in the world of bathrooms.





Composite in polyurethane base with mineral fillers



Resistant to thermal shock



Antislip Class C
*Beton / Slate / Slate Evo / Arabba / Wave / Zero



Sound insulation
(DIN 4109 / SIA181 / DIN EN ISO 717-2:2020-01)



Antibacterial certificate
(ISO 22196:2011)



Easy to cut



Class 1 in UNE-EN 14527:2016 + A1:2019



High definition textures



Hydrolysis resistant. 0% ortoftal-polyester



Safe cut. Material without silica



Cleanability



Material 25% lighter than similar materials



Chemical resistance



Evaluation of VOCs emissions of interior products (ISO 16000-6:2006) A+ and evaluation of CMR



Impact resistant



All colours in all textures

Texture

Our collections are designed to reproduce high-definition, sophisticated and elegant textures. With astonishing realism, we have captured textures from nature. Acquabella's textures are also pleasant to the touch, able to transport us to a universe of sensations for the five senses.

Wave



Quiz

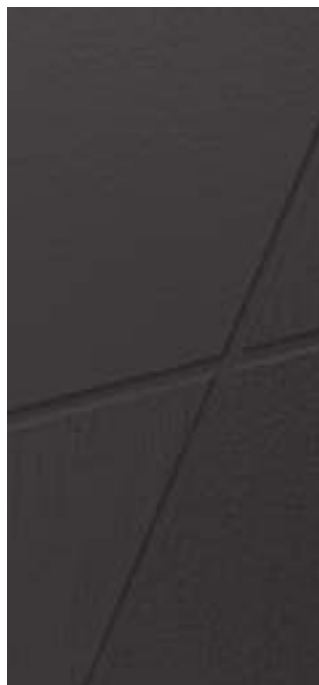

Arabba





Beton

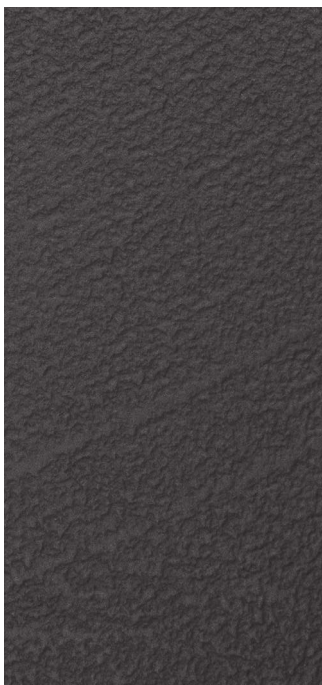

Slate



Zero

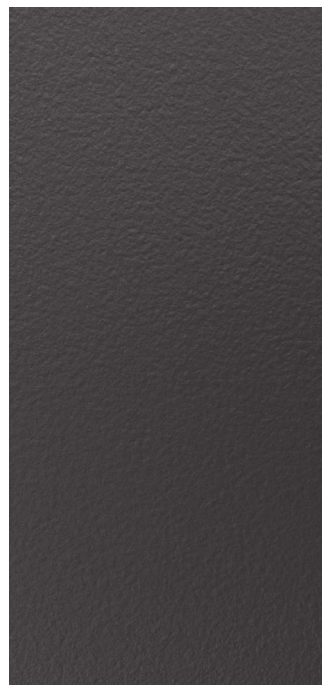

Nude

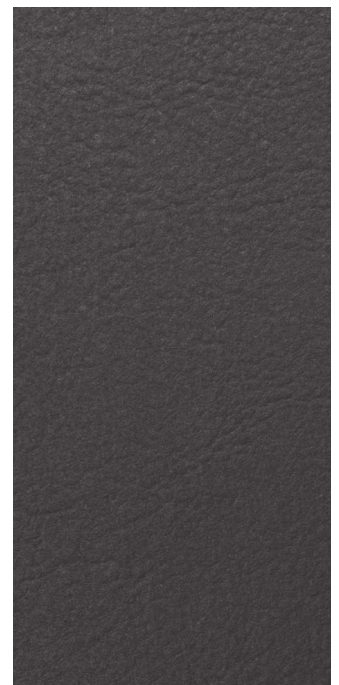

COLOURS STANDARD



COLOURS NATURALLY MADE

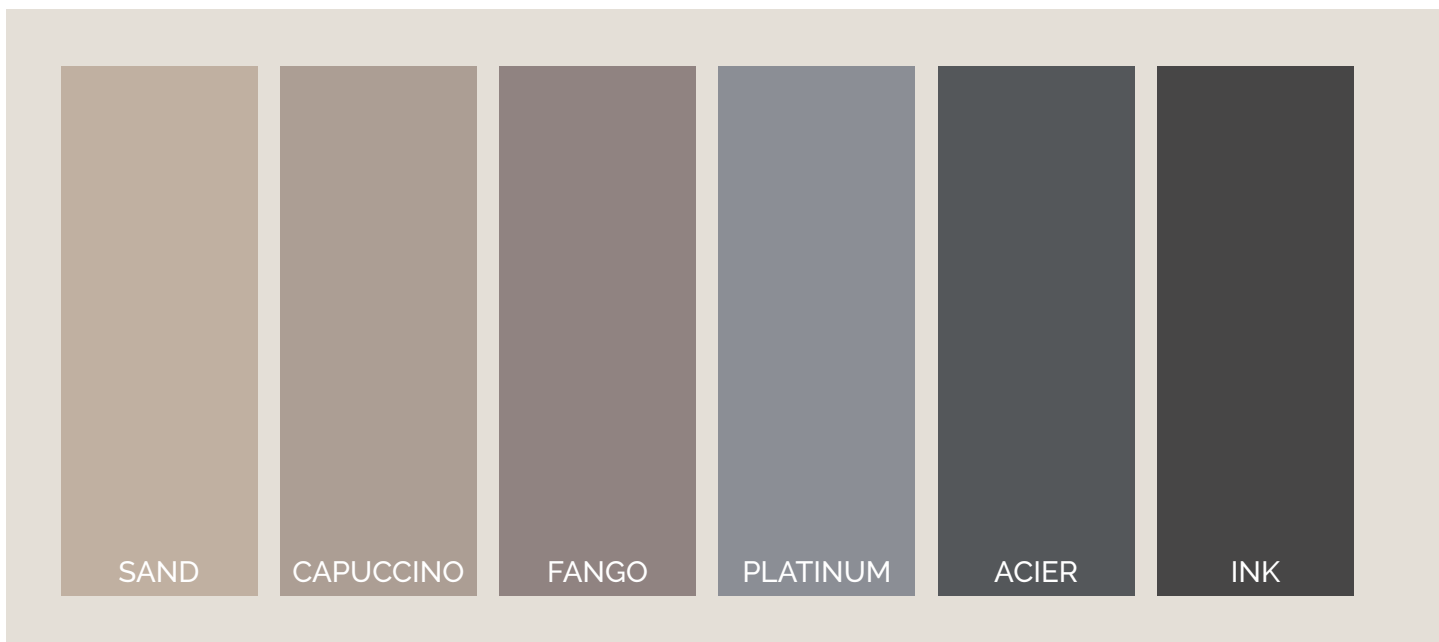

Colours

Colour is how we express emotion. Colour allows us to give free rein to our creativity and design inspiring bathroom spaces. We have four colour ranges: Standard, made up of versatile timeless shades; Naturally Made, inspired by the power of nature; Season, new this year, a careful selection of on-trend colours; and finally, the RAL/NCS chart with more than 2,000 colours. With Acquabella, your imagination is the limit.

COLOURS RAL/NCS



NCS S 6020-B90G

NOTE: examples NCS

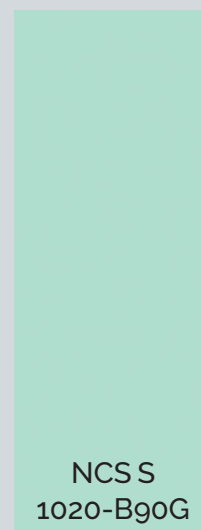
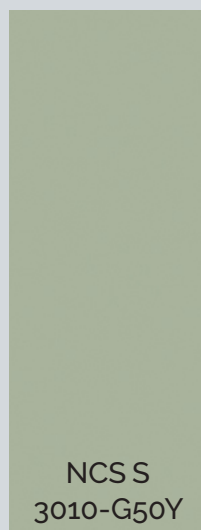
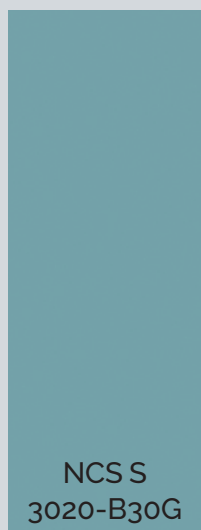

Colours Season

Standard bearers of design and fashion, we have made a special selection of colours to fill your bathroom with colour and freshness. Vibrant tones that, far from being overpowering, convey a sense of calm and sophistication. Season is a range of elegant shades, each in light and dark versions, ideal to create contrast and unique colour schemes. It's time to broaden your horizons with Acquabella's Season colours.





Dolotek

Thanks to modern technology, rock formed millions of years ago can be used to make durable, elegant and contemporary products. Dolotek's performance is better than traditional materials, which is why it is often called a 21st century ceramic. Formed from a resin and dolomite stone to give a pure white, soft feeling material.

Dolotek's properties mean that it can be used in functional products of high technical quality which can be moulded into complex shapes to improve our daily lives. The technology used to make Dolotek was developed in an efficient and environmentally friendly way and is unique in the bathroom industry.





Composite of polyester resin and dolomite stone



Resistant to thermal shock



High performance coating



Sound insulation



Antibacterial certificate
(ISO 22196:2007)



Durability



Cleanability



Versatility



UV ray-resistant



Silky touch



Resistance to fire



Precision



Resistance to chemicals



Evaluation of VOCs emissions of interior products (ISO 16000-6:2006) A+ and evaluation of CMR





Shower trays

New grids concept 22-23

Base Slate 24-35

Base Beton 36-43

Base Zero 44-49

Base Nude 50-55

Arq Zero 56-63

Unic Slate 64-73

Halo Slate 74-83

Areia Slate Evo 84-93

Natur Wave 94-103

Smart Quiz 104-111

Tempo Arabba 112-119

Flow Zero 120-127

Focus Beton 128-135

Prisma Slate 136-141

The evolution of our essence

In our quest to reinvent ourselves every day, Base and Arq have developed to include new customisation options, making it even more flexible. We have an innovative collection of grids to choose from: Mia (available in Akron and Inox finishes), Geo and Lux (only available in Akron).



MIA INOX





MIA

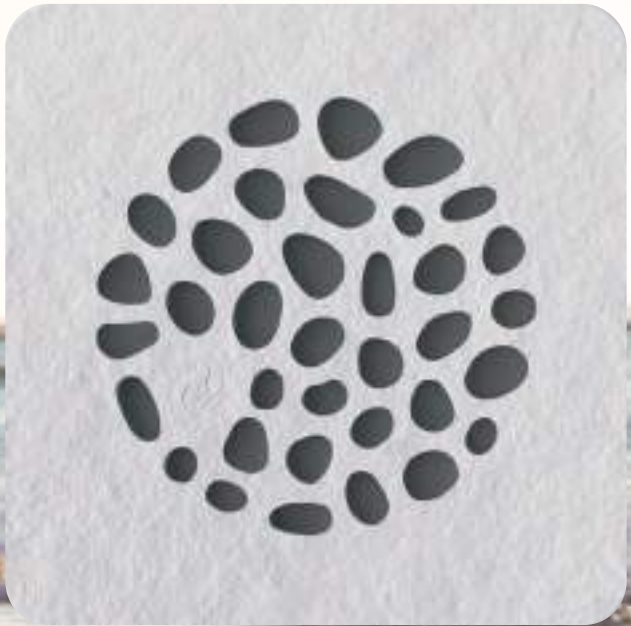

GEO



LUX

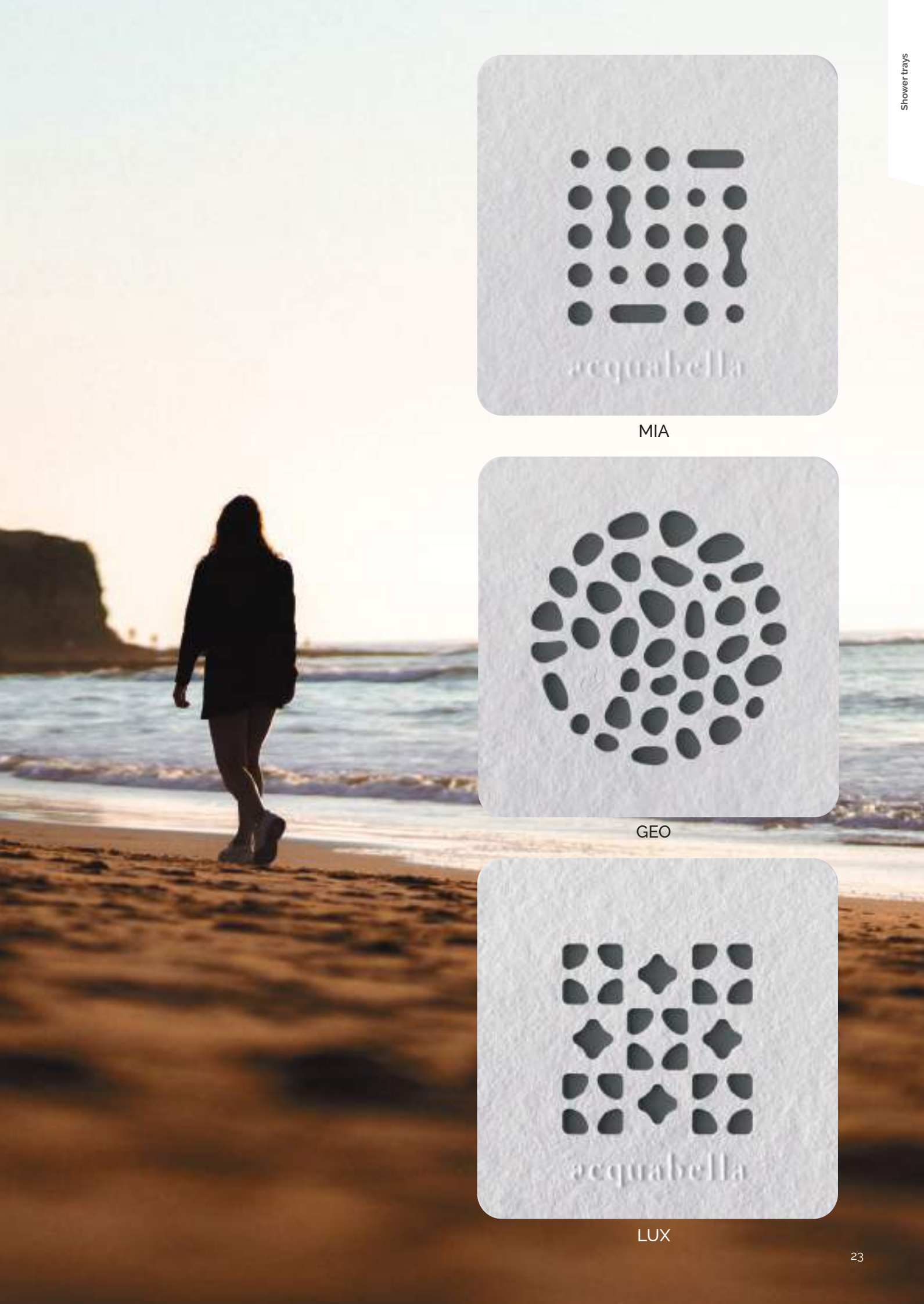



Base Slate

An indispensable bathroom essential, Base is dressed in our elegant Slate texture to fill your space with functionality. The Base Slate shower tray fits perfectly in any bathroom, thanks to its wide variety of formats and optional special dimensions.

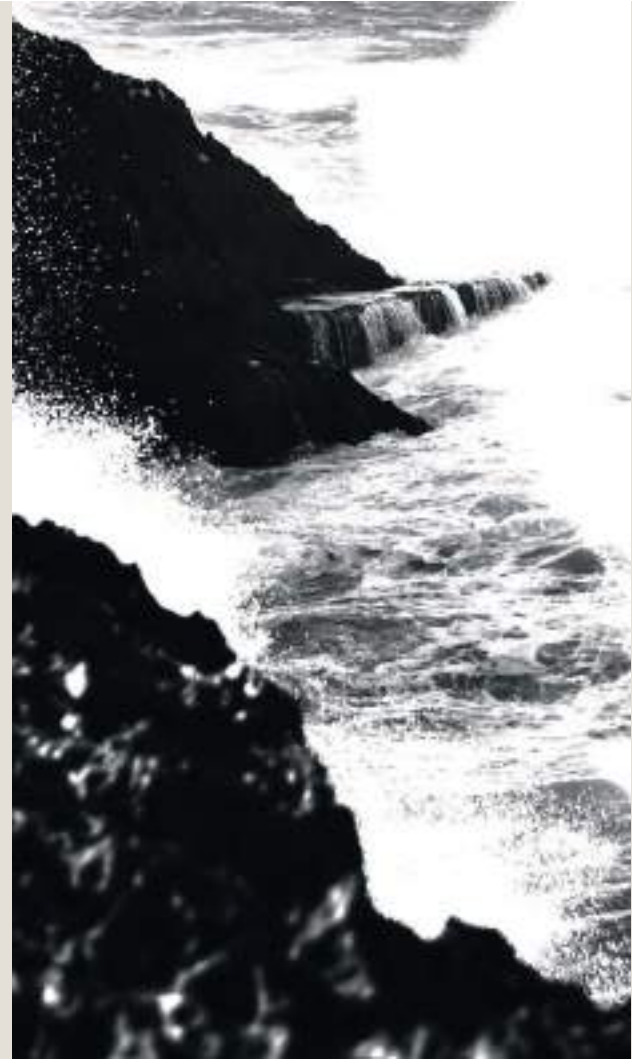

Standard sizes (cm)

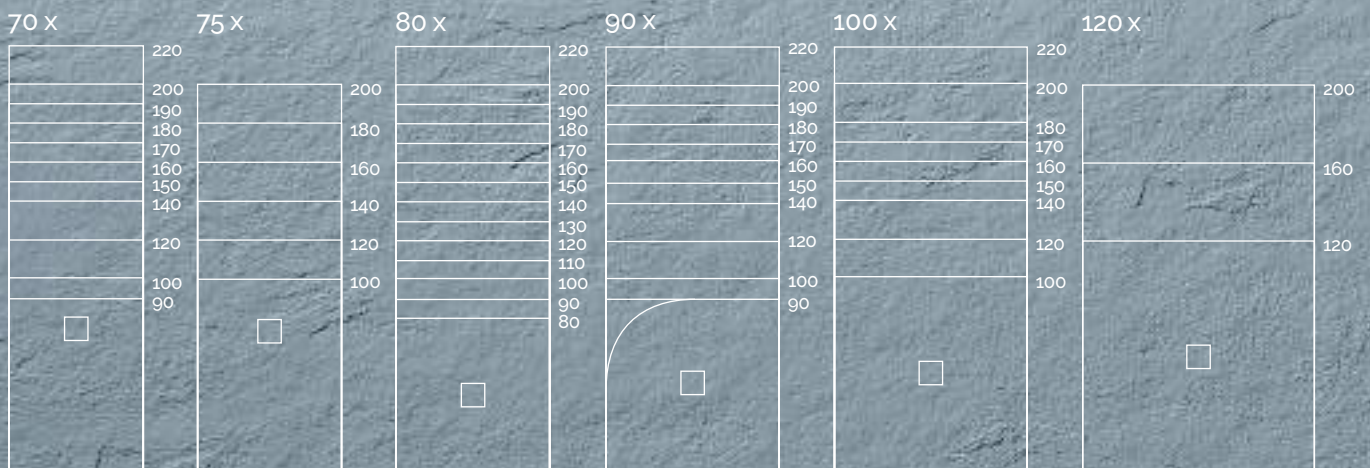

Available grids

Mia inox



Mia



Geo

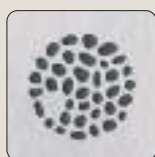

Lux

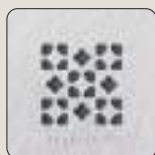











Base Slate

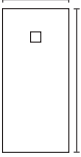
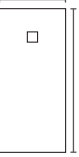

Base Slate blanco 150x90 cm

Stainless steel grid price list

70	L (cm)	Standard	Nat. Made	Season	Ral/NCS	80	L (cm)	Standard	Nat. Made	Season	Ral/NCS
 60 - 70	80 - 90	£515	£566	£566	£618	 76 - 80	70 - 80	£478	£527	£527	£574
	80 - 100	£567	£615	£615	£664		80 - 90	£571	£629	£629	£685
	101 - 120	£611	£665	£665	£717		80 - 100	£594	£645	£645	£697
	121 - 140	£673	£732	£732	£791		101 - 110	£618	£679	£679	£741
	141 - 150	£705	£769	£769	£831		111 - 120	£673	£732	£732	£791
	151 - 160	£734	£800	£800	£864		121 - 130	£700	£770	£770	£840
	161 - 170	£817	£891	£891	£965		131 - 140	£750	£817	£817	£884
	171 - 180	£845	£921	£921	£999		141 - 150	£784	£854	£854	£924
	181 - 190	£862	£940	£940	£1018		151 - 160	£840	£915	£915	£991
	191 - 200	£901	£984	£984	£1065		161 - 170	£901	£984	£984	£1065
201 - 220	£935	£1020	£1020	£1106	171 - 180	£912	£997	£997	£1078		
 71 - 75	80 - 100	£584	£633	£633	£683	171 - 180	£912	£997	£997	£1078	
	101 - 120	£644	£701	£701	£757	181 - 190	£922	£1008	£1008	£1091	
	121 - 140	£717	£781	£781	£844	191 - 200	£968	£1057	£1057	£1145	
	141 - 160	£801	£873	£873	£945	191 - 200	£968	£1057	£1057	£1145	
	161 - 180	£873	£952	£952	£1031	201 - 220	£1010	£1104	£1104	£1196	
	181 - 200	£935	£1020	£1020	£1106						



Colours

Standard



Naturally Made

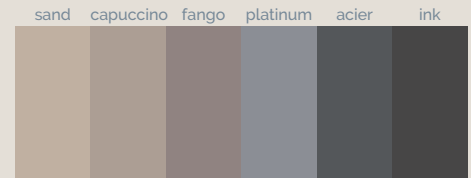

Season

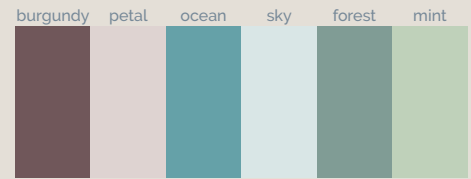

Ra/NCS

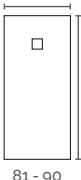
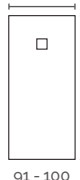

90	L (cm)	Standard	Nat. Made	Season	Ra/NCS	100	L (cm)	Standard	Nat. Made	Season	Ra/NCS
 81 - 90	80 - 90	£ 599	£ 651	£ 651	£ 703	 91 - 100	80 - 100	£ 700	£ 763	£ 763	£ 825
	80 - 90	£ 606	£ 659	£ 659	£ 711		101 - 120	£ 795	£ 866	£ 866	£ 938
	80 - 100	£ 616	£ 670	£ 670	£ 724		121 - 140	£ 901	£ 984	£ 984	£ 1065
	110 - 120	£ 729	£ 793	£ 793	£ 857		141 - 150	£ 1028	£ 1124	£ 1124	£ 1219
	110 - 120	£ 729	£ 793	£ 793	£ 857		151 - 160	£ 1124	£ 1229	£ 1229	£ 1332
	101 - 120	£ 729	£ 793	£ 793	£ 857		161 - 170	£ 1258	£ 1377	£ 1377	£ 1493
	121 - 140	£ 817	£ 891	£ 891	£ 965		171 - 180	£ 1302	£ 1425	£ 1425	£ 1547
	141 - 150	£ 873	£ 952	£ 952	£ 1031		171 - 180	£ 1302	£ 1425	£ 1425	£ 1547
	151 - 160	£ 963	£ 1051	£ 1051	£ 1138		181 - 200	£ 1330	£ 1455	£ 1455	£ 1580
	161 - 170	£ 1052	£ 1149	£ 1149	£ 1245		181 - 200	£ 1330	£ 1455	£ 1455	£ 1580
	171 - 180	£ 1124	£ 1229	£ 1229	£ 1332		201 - 220	£ 1398	£ 1530	£ 1530	£ 1662
	171 - 180	£ 1124	£ 1229	£ 1229	£ 1332						
181 - 190	£ 1158	£ 1266	£ 1266	£ 1374							
191 - 200	£ 1308	£ 1431	£ 1431	£ 1554							
191 - 200	£ 1308	£ 1431	£ 1431	£ 1554							
201 - 220	£ 1365	£ 1494	£ 1494	£ 1622							
						120	L (cm)	Standard	Nat. Made	Season	Ra/NCS
							100 - 120	£ 1028	£ 1124	£ 1124	£ 1219
							121 - 160	£ 1269	£ 1388	£ 1388	£ 1506
							161 - 200	£ 1475	£ 1615	£ 1615	£ 1755

Base Slate

Akron grid price list (Mia / Geo / Lux)

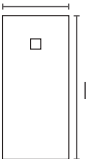
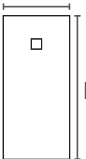
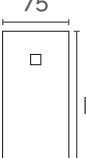
70						80					
	L (cm)	Standard	Nat. Made	Season	RaL/NCS		L (cm)	Standard	Nat. Made	Season	RaL/NCS
 60 - 70	80 - 90	£540	£594	£594	£648	 76 - 80	70 - 80	£501	£553	£553	£602
	80 - 100	£595	£645	£645	£697		80 - 90	£599	£660	£660	£719
	101 - 120	£641	£698	£698	£752		80 - 100	£623	£677	£677	£731
	121 - 140	£706	£768	£768	£830		101 - 110	£648	£712	£712	£778
	141 - 150	£740	£807	£807	£872		111 - 120	£706	£768	£768	£830
	151 - 160	£770	£840	£840	£907		121 - 130	£735	£808	£808	£882
	161 - 170	£857	£935	£935	£1013		131 - 140	£787	£857	£857	£928
	171 - 180	£887	£967	£967	£1048		141 - 150	£823	£896	£896	£970
	181 - 190	£905	£987	£987	£1068		151 - 160	£882	£960	£960	£1040
	191 - 200	£946	£1033	£1033	£1118		161 - 170	£946	£1033	£1033	£1118
201 - 220	£981	£1071	£1071	£1161	171 - 180	£957	£1046	£1046	£1131		
 71 - 75	80 - 100	£613	£664	£664	£717	171 - 180	£957	£1046	£1046	£1131	
	101 - 120	£676	£736	£736	£794	181 - 190	£968	£1058	£1058	£1145	
	121 - 140	£752	£820	£820	£886	191 - 200	£1016	£1109	£1109	£1202	
	141 - 160	£841	£916	£916	£992	191 - 200	£1016	£1109	£1109	£1202	
	161 - 180	£916	£999	£999	£1082	201 - 220	£1060	£1159	£1159	£1255	
	181 - 200	£981	£1071	£1071	£1161						

Colours

Standard

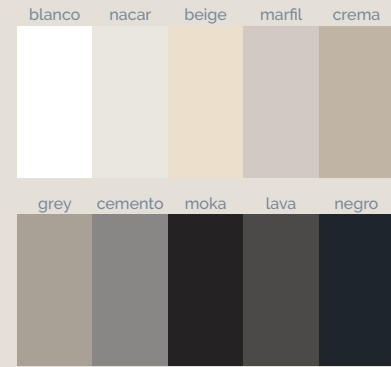

Naturally Made



Season

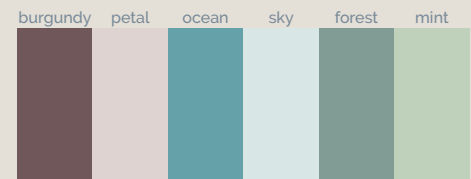

Ra/NCS







Base Geo Slate NCS S 7020-R80B 200x100 cm

90						100					120										
	L (cm)	Standard	Nat. Made	Season	Ra/NCS		L (cm)	Standard	Nat. Made	Season	Ra/NCS		L (cm)	Standard	Nat. Made	Season	Ra/NCS				
 81 - 90	80 - 90	£ 628	£ 683	£ 683	£ 738	 91 - 100	80 - 100	£ 735	£ 801	£ 801	£ 866	 101 - 120	100 - 120	£ 1079	£ 1180	£ 1180	£ 1279				
	80 - 90	£ 636	£ 691	£ 691	£ 746		101 - 120	£ 834	£ 909	£ 909	£ 984		121 - 140	£ 946	£ 1033	£ 1033	£ 1118				
	80 - 100	£ 646	£ 703	£ 703	£ 760		141 - 150	£ 1079	£ 1180	£ 1180	£ 1279		151 - 160	£ 1180	£ 1290	£ 1290	£ 1398				
	110 - 120	£ 765	£ 832	£ 832	£ 899		161 - 170	£ 1320	£ 1445	£ 1445	£ 1567		171 - 180	£ 1367	£ 1496	£ 1496	£ 1624				
	110 - 120	£ 765	£ 832	£ 832	£ 899		171 - 180	£ 1367	£ 1496	£ 1496	£ 1624		181 - 200	£ 1396	£ 1527	£ 1527	£ 1659				
	101 - 120	£ 765	£ 832	£ 832	£ 899		181 - 200	£ 1396	£ 1527	£ 1527	£ 1659		201 - 220	£ 1467	£ 1606	£ 1606	£ 1745				
	121 - 140	£ 857	£ 935	£ 935	£ 1013																
	141 - 150	£ 916	£ 999	£ 999	£ 1082																
	151 - 160	£ 1011	£ 1103	£ 1103	£ 1194																
	161 - 170	£ 1104	£ 1206	£ 1206	£ 1307																
	171 - 180	£ 1180	£ 1290	£ 1290	£ 1398																
	171 - 180	£ 1180	£ 1290	£ 1290	£ 1398																
181 - 190	£ 1215	£ 1329	£ 1329	£ 1442																	
191 - 200	£ 1373	£ 1502	£ 1502	£ 1631																	
191 - 200	£ 1373	£ 1502	£ 1502	£ 1631																	
201 - 220	£ 1433	£ 1568	£ 1568	£ 1703																	

NOTE: only one model of grid per shower tray is included, to choose between: Mia, Geo or Lux.

BASE SLATECOMPLEMENTS

Grid

		Texture	Sizes (cm)	Price	Standard	Nat. Made	Season	RaL/NCS
	Mia stainless steel grid	-	12 x 12	£ 25	✓	✓	✓	✓
	Mia Akron grid	Slate	12 x 12	£ 70	✓	✓	✓	✓
	Geo Akron grid	Slate	12 x 12	£ 70	✓	✓	✓	✓
	Lux Akron grid	Slate	12 x 12	£ 70	✓	✓	✓	✓

NOTE: only one model of grid per shower tray is included, to choose between: Mia, Geo or Lux.

Traps (mm)

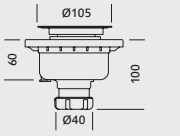
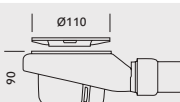
					Price
	Standard trap			✓	-
	Vertical trap			✓	-
	Extraflat trap			🛒	£ 59
	High flow trap			🛒	£ 76

NOTE: only one model of trap per shower tray is included.

Frame

		Texture	Sizes (cm)		Standard	Nat. Made	Season	RaL/NCS
	Frame	Slate	4,1 x 5	🛒	£ 1,37 cm linear	£ 1,51 cm linear	£ 1,51 cm linear	£ 1,64 cm linear



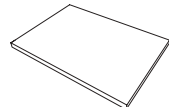

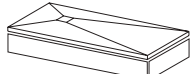

Drying area

		Texture	Sizes (cm)		Standard	Nat. Made	Season	RaL/NCS
	Drying area	Slate	100 x 100 x 2,3	🛒	£ 618	£ 679	£ 679	£ 741

Skirt

		Texture	Sizes (cm)		Standard	Nat. Made	Season	RaL/NCS
	Skirt	Slate	60 - 220 x 9 x 1,6	🛒	£ 1,30 cm linear	£ 1,37 cm linear	£ 1,37 cm linear	£ 1,42 cm linear

Installation materials

				Price
	Basic waterproofing set	Kerdi-TS Schlüter Systems		£ 259
	Adhesive glue	Ultrabond MS Rapid		£ 27
	Joint sealant	Mapesil AC		£ 19



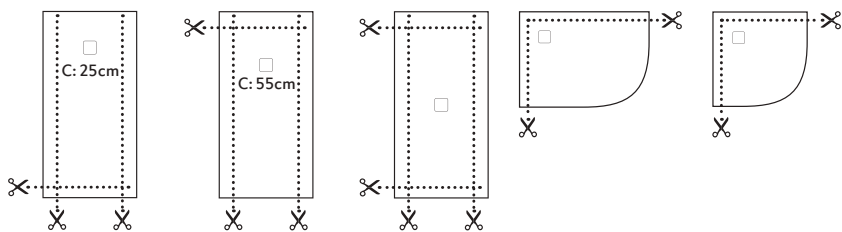

BASE SLATE TECHNICAL INFORMATION



Bespoke cut

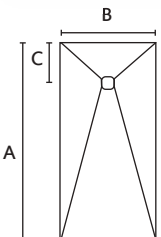
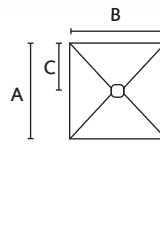

	Price
	£ 36

Sizes

	A (cm)	B (cm)	C (cm)		A (cm)	B (cm)	C (cm)
	90	70/80	25		80	80	40
	100	70/75/80/90	25		90	90	45
	110	80	25		100	100	50
	120	70/75/80/90/100	25		120	120	60
	130	80	25				
	140	70/75/80/90/100	55				
	150	70/80/90/100	55				
	160	70/75/80/90/100/120	55				
	170	70/80/90/100	55				
	180	70/75/80/90/100	55				
180	 80/90/100	90					
190	70/80/90	55					
200	70/75/80/90/100/120	55					
200	 80/90/100	100					
220	 70/80/90/100	110					

	A (cm)	B (cm)	C (cm)
90 	90	90	26
90 Dx 	120	120	27
90 Sx 	120	120	27

Tests

Texture	Test	Result
SLATE	UNE EN 16165:2022 Annex A	CLASS C
	French normative XP P 05-010	PN 24

Product data sheet

Installation manual





Base Beton

A made-to-measure Base Beton shower tray can add a touch of freshness to any bathroom thanks to its cement-like finish. Its simplicity makes it perfect to combine with other finishes, while its playful texture will make it the focal point of any bathroom.



Standard sizes (cm)

70 x

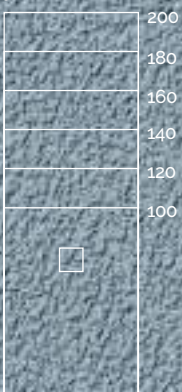

80 x

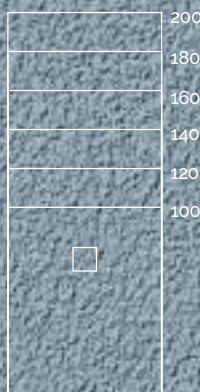

90 x

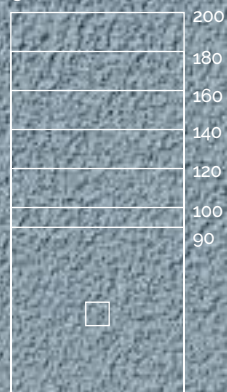

100 x

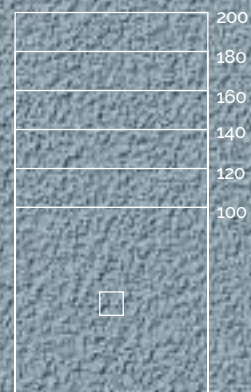

Available grids

Mia inox



Mia



Geo



Lux







Base Beton



Base Mia Beton NCS S 3040-Y60R 200x100 cm

Stainless steel grid price list

70						80					
L (cm)	Standard	Nat. Made	Season	Ra/NCS	L (cm)	Standard	Nat. Made	Season	Ra/NCS		
80 - 100	£567	£615	£615	£664	80 - 100	£584	£633	£633	£683		
101 - 120	£611	£665	£665	£717	101 - 120	£673	£732	£732	£791		
121 - 140	£673	£732	£732	£791	121 - 140	£750	£817	£817	£884		
141 - 160	£734	£800	£800	£864	141 - 160	£840	£915	£915	£991		
161 - 180	£845	£921	£921	£999	161 - 180	£912	£997	£997	£1078		
181 - 200	£901	£984	£984	£1065	181 - 200	£968	£1057	£1057	£1145		

Akron grid price list (Mia / Geo / Lux)

70						80					
L (cm)	Standard	Nat. Made	Season	Ra/NCS	L (cm)	Standard	Nat. Made	Season	Ra/NCS		
80 - 100	£595	£645	£645	£697	80 - 100	£613	£664	£664	£717		
101 - 120	£641	£698	£698	£752	101 - 120	£706	£768	£768	£830		
121 - 140	£706	£768	£768	£830	121 - 140	£787	£857	£857	£928		
141 - 160	£770	£840	£840	£907	141 - 160	£882	£960	£960	£1040		
161 - 180	£887	£967	£967	£1048	161 - 180	£957	£1046	£1046	£1131		
181 - 200	£946	£1033	£1033	£1118	181 - 200	£1016	£1109	£1109	£1202		



Colours

Standard

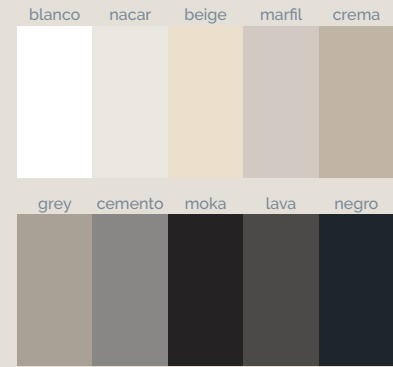

Naturally Made

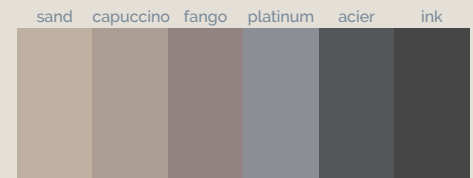

Season

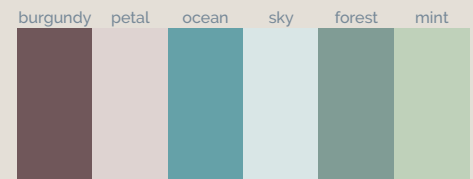

Ra/NCS



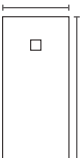
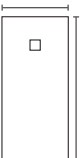

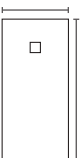
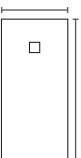

90	L (cm)	Standard	Nat. Made	Season	Ra/NCS	100	L (cm)	Standard	Nat. Made	Season	Ra/NCS
 81 - 90	80 - 90	£ 606	£ 659	£ 659	£ 711	 91 - 100	80 - 100	£ 700	£ 763	£ 763	£ 825
	80 - 100	£ 616	£ 670	£ 670	£ 724		101 - 120	£ 795	£ 866	£ 866	£ 938
	101 - 120	£ 729	£ 793	£ 793	£ 857		121 - 140	£ 901	£ 984	£ 984	£ 1065
	121 - 140	£ 817	£ 891	£ 891	£ 965		141 - 160	£ 1124	£ 1229	£ 1229	£ 1332
	141 - 160	£ 963	£ 1051	£ 1051	£ 1138		161 - 180	£ 1302	£ 1425	£ 1425	£ 1547
	161 - 180	£ 1124	£ 1229	£ 1229	£ 1332		181 - 200	£ 1330	£ 1455	£ 1455	£ 1580
	181 - 200	£ 1308	£ 1431	£ 1431	£ 1554						

90	L (cm)	Standard	Nat. Made	Season	Ra/NCS	100	L (cm)	Standard	Nat. Made	Season	Ra/NCS
 81 - 90	80 - 90	£ 636	£ 691	£ 691	£ 746	 91 - 100	80 - 100	£ 735	£ 801	£ 801	£ 866
	80 - 100	£ 646	£ 703	£ 703	£ 760		101 - 120	£ 834	£ 909	£ 909	£ 984
	101 - 120	£ 765	£ 832	£ 832	£ 899		121 - 140	£ 946	£ 1033	£ 1033	£ 1118
	121 - 140	£ 857	£ 935	£ 935	£ 1013		141 - 160	£ 1180	£ 1290	£ 1290	£ 1398
	141 - 160	£ 1011	£ 1103	£ 1103	£ 1194		161 - 180	£ 1367	£ 1496	£ 1496	£ 1624
	161 - 180	£ 1180	£ 1290	£ 1290	£ 1398		181 - 200	£ 1396	£ 1527	£ 1527	£ 1659
	181 - 200	£ 1373	£ 1502	£ 1502	£ 1631						

NOTE: only one model of grid per shower tray is included, to choose between: Mia, Geo or Lux.

BASE BETON COMPLEMENTS

Grid

		Texture	Sizes (cm)	Price	Standard	Nat. Made	Season	RaL/NCS
	Mia stainless steel grid	-	12 x 12	£ 25	✓	✓	✓	✓
	Mia Akron grid	Beton	12 x 12	£ 70	✓	✓	✓	✓
	Geo Akron grid	Beton	12 x 12	£ 70	✓	✓	✓	✓
	Lux Akron grid	Beton	12 x 12	£ 70	✓	✓	✓	✓

NOTE: only one model of grid per shower tray is included, to choose between: Mia, Geo or Lux.

Traps (mm)

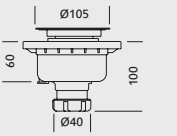
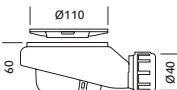
					Price
	Standard trap			✓	-
	Vertical trap			✓	-
	Extraflat trap			🛒	£ 59
	High flow trap			🛒	£ 76

NOTE: only one model of trap per shower tray is included.







Frame

		Texture	Sizes (cm)		Standard	Nat. Made	Season	RaL/NCS
	Frame	Beton	4,1 x 5	🛒	£ 1,37 cm linear	£ 1,51 cm linear	£ 1,51 cm linear	£ 1,64 cm linear

Skirt

		Texture	Sizes (cm)		Standard	Nat. Made	Season	RaL/NCS
	Skirt	Beton	60 - 200 x 9 x 1,6	🛒	£ 1,30 cm linear	£ 1,37 cm linear	£ 1,37 cm linear	£ 1,42 cm linear

Installation materials

				Price
	Basic waterproofing set	Kerdi-TS Schlüter Systems		£ 259
	Adhesive glue	Ultrabond MS Rapid		£ 27
	Joint sealant	Mapesil AC		£ 19

BASE BETON TECHNICAL INFORMATION

Bespoke cut

			Price £ 36
--	--	---	---------------

Sizes

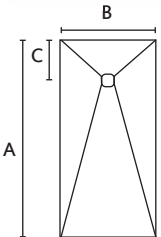
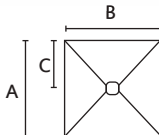
	A (cm)	B (cm)	C (cm)		A (cm)	B (cm)	C (cm)
	100	70/80/90	25		90	90	45
	120	70/80/90/100	25		100	100	50
	140	70/80/90/100	55				
	160	70/80/90/100	55				
	180	70/80/90/100	55				
	200	70/80/90/100	55				

Tests

Texture	Test	Result
BETON	UNE-EN 16165:2022 Annex A	CLASS C
	French normative XP P 05-010	PN 24

Product data sheet



Installation manual





Base Zero

A virtually smooth micro-texture forms the Base Zero made-to-measure shower tray, making it a basic component of any modern design. Its minimalist aesthetic gives a versatile and timeless feel, essential for homes and hotels. Base Zero will give any bathroom with an unmatched sense of space.

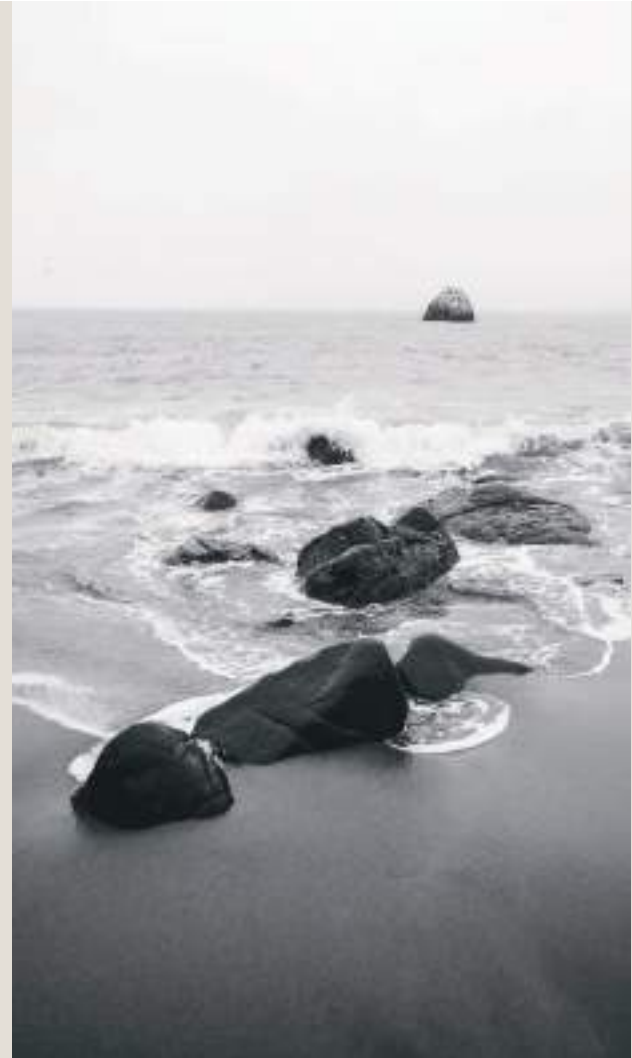

Standard sizes (cm)

70 x

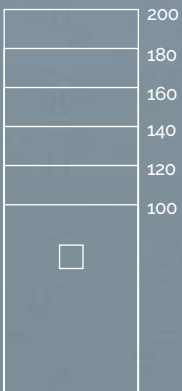

80 x



90 x

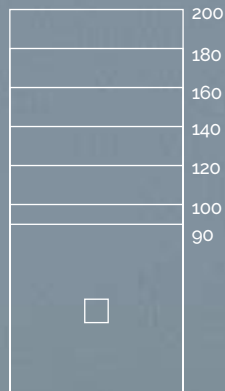

100 x

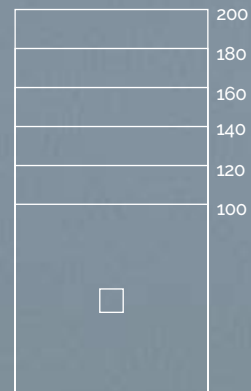

Available grids

Mia inox



Mia



Geo



Lux



Base Zero



Stainless steel grid price list

70						80					
L (cm)	Standard	Nat. Made	Season	Ra/NCS	L (cm)	Standard	Nat. Made	Season	Ra/NCS		
80 - 100	£567	£615	£615	£664	80 - 100	£584	£633	£633	£683		
101 - 120	£611	£665	£665	£717	101 - 120	£673	£732	£732	£791		
121 - 140	£673	£732	£732	£791	121 - 140	£750	£817	£817	£884		
141 - 160	£734	£800	£800	£864	141 - 160	£840	£915	£915	£991		
161 - 180	£845	£921	£921	£999	161 - 180	£912	£997	£997	£1078		
181 - 200	£901	£984	£984	£1065	181 - 200	£968	£1057	£1057	£1145		

Akron grid price list (Mia / Geo / Lux)

70						80					
L (cm)	Standard	Nat. Made	Season	Ra/NCS	L (cm)	Standard	Nat. Made	Season	Ra/NCS		
80 - 100	£595	£645	£645	£697	80 - 100	£613	£664	£664	£717		
101 - 120	£641	£698	£698	£752	101 - 120	£706	£768	£768	£830		
121 - 140	£706	£768	£768	£830	121 - 140	£787	£857	£857	£928		
141 - 160	£770	£840	£840	£907	141 - 160	£882	£960	£960	£1040		
161 - 180	£887	£967	£967	£1048	161 - 180	£957	£1046	£1046	£1131		
181 - 200	£946	£1033	£1033	£1118	181 - 200	£1016	£1109	£1109	£1202		



Base Mia Zero negro 200x100 cm

Colours

Standard



Naturally Made

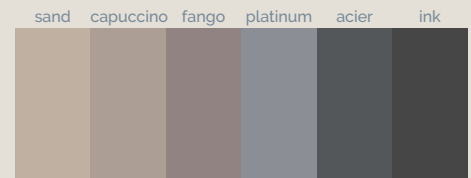

Season

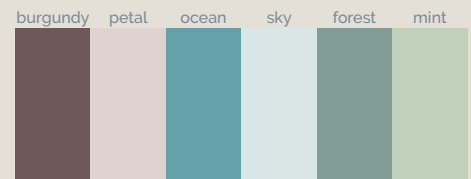

Ra/NCS







90	L (cm)	Standard	Nat. Made	Season	Ra/NCS	100	L (cm)	Standard	Nat. Made	Season	Ra/NCS
81 - 90	80 - 90	£ 606	£ 659	£ 659	£ 711	91 - 100	80 - 100	£ 700	£ 763	£ 763	£ 825
	80 - 100	£ 616	£ 670	£ 670	£ 724		101 - 120	£ 795	£ 866	£ 866	£ 938
	101 - 120	£ 729	£ 793	£ 793	£ 857		121 - 140	£ 901	£ 984	£ 984	£ 1065
	121 - 140	£ 817	£ 891	£ 891	£ 965		141 - 160	£ 1124	£ 1229	£ 1229	£ 1332
	141 - 160	£ 963	£ 1051	£ 1051	£ 1138		161 - 180	£ 1302	£ 1425	£ 1425	£ 1547
	161 - 180	£ 1124	£ 1229	£ 1229	£ 1332		181 - 200	£ 1330	£ 1455	£ 1455	£ 1580
	181 - 200	£ 1308	£ 1431	£ 1431	£ 1554						

90	L (cm)	Standard	Nat. Made	Season	Ra/NCS	100	L (cm)	Standard	Nat. Made	Season	Ra/NCS
81 - 90	80 - 90	£ 636	£ 691	£ 691	£ 746	91 - 100	80 - 100	£ 735	£ 801	£ 801	£ 866
	80 - 100	£ 646	£ 703	£ 703	£ 760		101 - 120	£ 834	£ 909	£ 909	£ 984
	101 - 120	£ 765	£ 832	£ 832	£ 899		121 - 140	£ 946	£ 1033	£ 1033	£ 1118
	121 - 140	£ 857	£ 935	£ 935	£ 1013		141 - 160	£ 1180	£ 1290	£ 1290	£ 1398
	141 - 160	£ 1011	£ 1103	£ 1103	£ 1194		161 - 180	£ 1367	£ 1496	£ 1496	£ 1624
	161 - 180	£ 1180	£ 1290	£ 1290	£ 1398		181 - 200	£ 1396	£ 1527	£ 1527	£ 1659
	181 - 200	£ 1373	£ 1502	£ 1502	£ 1631						

Shipping in 48h after the order for shower trays Base Zero blanco, marfil and negro.
NOTE: only one model of grid per shower tray is included, to choose between: Mia, Geo or Lux.

BASE ZERO COMPLEMENTS

Grid

		Texture	Sizes (cm)	Price	Standard	Nat. Made	Season	RaL/NCS
	Mia stainless steel grid	-	12 x 12	£ 25	✓	✓	✓	✓
	Mia Akron grid	Zero	12 x 12	£ 70	✓	✓	✓	✓
	Geo Akron grid	Zero	12 x 12	£ 70	✓	✓	✓	✓
	Lux Akron grid	Zero	12 x 12	£ 70	✓	✓	✓	✓

NOTE: only one model of grid per shower tray is included, to choose between: Mia, Geo or Lux.

Traps (mm)

					Price
	Standard trap			✓	-
	Vertical trap			✓	-
	Extraflat trap			🛒	£ 59
	High flow trap			🛒	£ 76

NOTE: only one model of trap per shower tray is included.



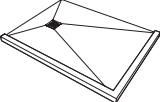



Frame

		Texture	Sizes (cm)		Standard	Nat. Made	Season	RaL/NCS
	Frame	Zero	4,1 x 5	🛒	£ 1,37 cm linear	£ 1,51 cm linear	£ 1,51 cm linear	£ 1,64 cm linear

Skirt

		Texture	Sizes (cm)		Standard	Nat. Made	Season	RaL/NCS
	Skirt	Zero	60 - 200 x 9 x 1,6	🛒	£ 1,30 cm linear	£ 1,37 cm linear	£ 1,37 cm linear	£ 1,42 cm linear

Installation materials

				Price
	Basic waterproofing set	Kerdi-TS Schlüter Systems		£ 259
	Adhesive glue	Ultrabond MS Rapid		£ 27
	Joint sealant	Mapesil AC		£ 19

BASE ZERO TECHNICAL INFORMATION

Bespoke cut

				Price £ 36
--	--	--	---	---------------

Sizes

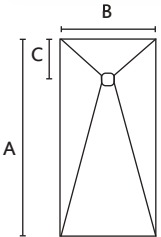
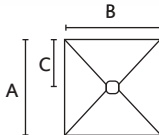
	A (cm)	B (cm)	C (cm)		A (cm)	B (cm)	C (cm)
	100	70/80/90	25		90	90	45
	120	70/80/90/100	25		100	100	50
	140	70/80/90/100	55				
	160	70/80/90/100	55				
	180	70/80/90/100	55				
	200	70/80/90/100	55				

Tests

Texture	Test	Result
ZERO	UNE-EN 16165:2022 Annex A	CLASS C
	French normative XP P 05-010	PN 24

Product data sheet



Installation manual





2,8 max
2,4 min
cm



Base Nude

Originality is the hallmark of the Base Nude made-to-measure shower tray. The unique high-definition Nude texture perfectly reproduces the look of skin, bringing warmth to the space. A shower tray that, thanks to its characteristic simplicity, puts the finish centre stage to create an innovative, elegant shower tray.



Standard sizes (cm)

80 x

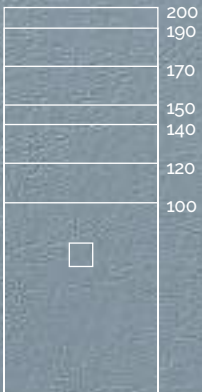

90 x

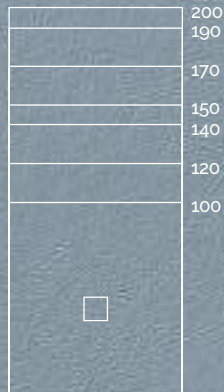

100 x

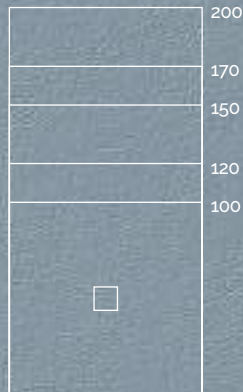

Available grids

Mia inox



Mia



Geo



Lux



Base Nude



Stainless steel grid price list

80					90				
L (cm)	Standard	Nat. Made	Season	Ra/NCS	L (cm)	Standard	Nat. Made	Season	Ra/NCS
80 - 100	£584	£633	£633	£683	80 - 100	£616	£670	£670	£724
101 - 120	£673	£732	£732	£791	101 - 120	£729	£793	£793	£857
121 - 140	£750	£817	£817	£884	121 - 140	£817	£891	£891	£965
141 - 150	£784	£854	£854	£924	141 - 150	£873	£952	£952	£1031
151 - 170	£901	£984	£984	£1065	151 - 170	£1052	£1149	£1149	£1245
171 - 190	£922	£1008	£1008	£1091	171 - 190	£1158	£1266	£1266	£1374
191 - 200	£968	£1057	£1057	£1145	191 - 200	£1308	£1431	£1431	£1554

Akron grid price list (Mia / Geo / Lux)

80					90				
L (cm)	Standard	Nat. Made	Season	Ra/NCS	L (cm)	Standard	Nat. Made	Season	Ra/NCS
80 - 100	£613	£664	£664	£717	80 - 100	£646	£703	£703	£760
101 - 120	£706	£768	£768	£830	101 - 120	£765	£832	£832	£899
121 - 140	£787	£857	£857	£928	121 - 140	£857	£935	£935	£1013
141 - 150	£823	£896	£896	£970	141 - 150	£916	£999	£999	£1082
151 - 170	£946	£1033	£1033	£1118	151 - 170	£1104	£1206	£1206	£1307
171 - 190	£968	£1058	£1058	£1145	171 - 190	£1215	£1329	£1329	£1442
191 - 200	£1016	£1109	£1109	£1202	191 - 200	£1373	£1502	£1502	£1631



Base Geo Nude crema 170x90 cm

Colours

Standard



Naturally Made

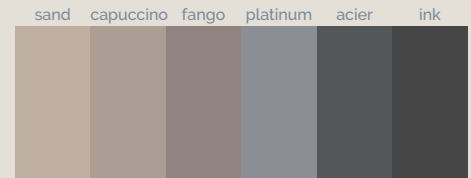

Season

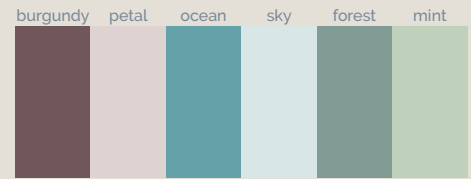

Ra/NCS







100	L (cm)	Standard	Nat. Made	Season	Ra/NCS
	80 - 100	£700	£763	£763	£825
	101 - 120	£795	£866	£866	£938
	121 - 150	£1028	£1124	£1124	£1219
	151 - 170	£1258	£1377	£1377	£1493
	171 - 200	£1330	£1455	£1455	£1580

100	L (cm)	Standard	Nat. Made	Season	Ra/NCS
	80 - 100	£735	£801	£801	£866
	101 - 120	£834	£909	£909	£984
	121 - 150	£1079	£1180	£1180	£1279
	151 - 170	£1320	£1445	£1445	£1567
	171 - 200	£1396	£1527	£1527	£1659

NOTE: only one model of grid per shower tray is included, to choose between: Mia, Geo or Lux.

BASE NUDECOMPLEMENTS

Grid

		Texture	Sizes (cm)	Price	Standard	Nat. Made	Season	RaI/NCS
	Mia stainless steel grid	-	12 x 12	£ 25	✓	✓	✓	✓
	Mia Akron grid	Nude	12 x 12	£ 70	✓	✓	✓	✓
	Geo Akron grid	Nude	12 x 12	£ 70	✓	✓	✓	✓
	Lux Akron grid	Nude	12 x 12	£ 70	✓	✓	✓	✓

NOTE: only one model of grid per shower tray is included, to choose between: Mia, Geo or Lux.

Traps (mm)

					Price
	Standard trap			✓	-
	Vertical trap			✓	-
	Extraflat trap			🛒	£ 59
	High flow trap			🛒	£ 76

NOTE: only one model of trap per shower tray is included.



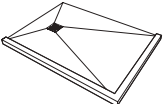

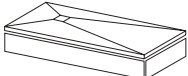

Frame

		Texture	Sizes (cm)		Standard	Nat. Made	Season	RaI/NCS
	Frame	Nude	4,1 x 5	🛒	£ 1,37 cm linear	£ 1,51 cm linear	£ 1,51 cm linear	£ 1,64 cm linear

Skirt

		Texture	Sizes (cm)		Standard	Nat. Made	Season	RaI/NCS
	Skirt	Nude	60 - 200 x 9 x 1,6	🛒	£ 1,30 cm linear	£ 1,37 cm linear	£ 1,37 cm linear	£ 1,42 cm linear

Installation materials

				Price
	Basic waterproofing set	Kerdi-TS Schlüter Systems		£ 259
	Adhesive glue	Ultrabond MS Rapid		£ 27
	Joint sealant	Mapesil AC		£ 19

BASE NUDE TECHNICAL INFORMATION

Bespoke cut

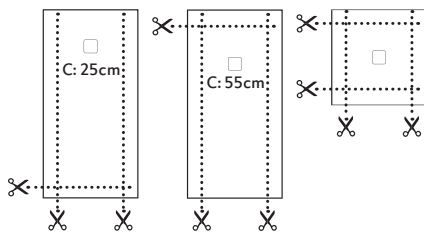

Price
 £ 36

Sizes

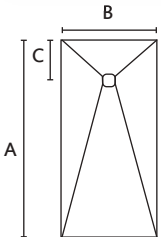
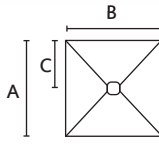
	A (cm)	B (cm)	C (cm)		A (cm)	B (cm)	C (cm)
	100	80/90	25		100	100	50
	120	80/90/100	25				
	140	80/90	55				
	150	80/90/100	55				
	170	80/90/100	55				
	190	80/90	55				
	200	80/90/100	55				

Tests

Texture	Test	Result
NUDE	UNE-EN 16165:2022 Annex A	CLASS B
	French normative XP P 05-010	PN 18

Product data sheet



Installation manual





Arq Zero

The Arq Zero made-to-measure shower tray has a frame, just like a work of art. It fits with the fashions of today while boasting a timeless design, thanks to Acquabella's Zero smooth microtexture. An unbeatable choice when it comes to replacing your bathroom shower tray.

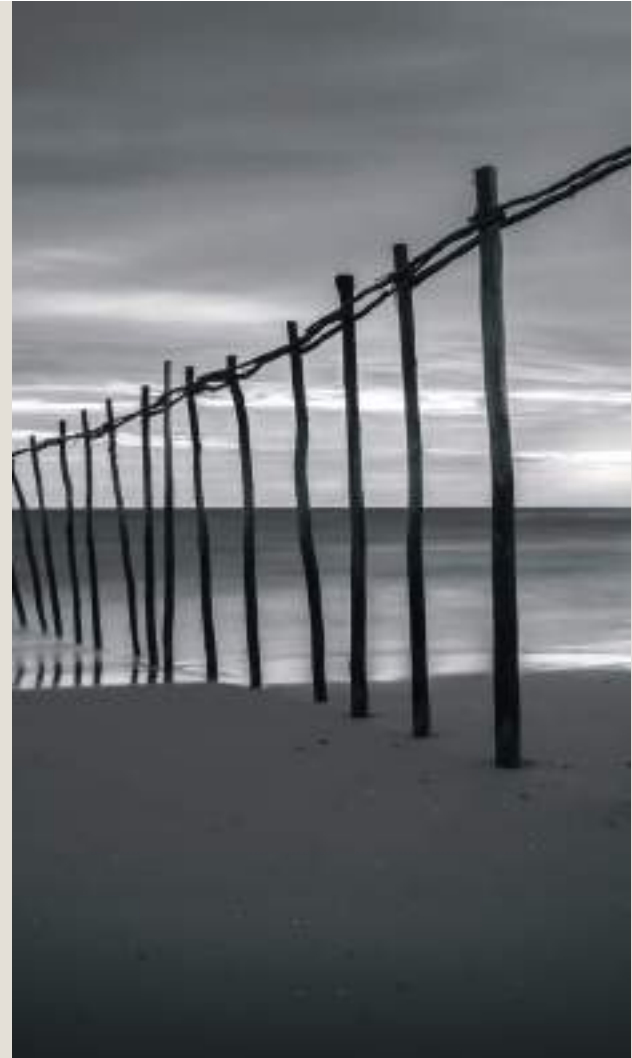

Standard sizes (cm)



Available grids

Mia inox



Mia



Geo



Lux







Arq Zero



Stainless steel grid price list

70					80				
L (cm)	Standard	Nat. Made	Season	RaL/NCS	L (cm)	Standard	Nat. Made	Season	RaL/NCS
100	£ 627	£ 681	£ 681	£ 736	100	£ 675	£ 734	£ 734	£ 794
120	£ 649	£ 706	£ 706	£ 764	120	£ 717	£ 781	£ 781	£ 844
140	£ 717	£ 781	£ 781	£ 844	140	£ 801	£ 873	£ 873	£ 945
150	£ 765	£ 833	£ 833	£ 901	150	£ 852	£ 908	£ 908	£ 1006
160	£ 784	£ 854	£ 854	£ 924	160	£ 917	£ 1002	£ 1002	£ 1084
170	£ 868	£ 947	£ 947	£ 1025	170	£ 945	£ 1031	£ 1031	£ 1117
180	£ 901	£ 984	£ 984	£ 1065	180	£ 973	£ 1062	£ 1062	£ 1152
200	£ 963	£ 1051	£ 1051	£ 1138	200	£ 1035	£ 1130	£ 1130	£ 1225

Akron grid price list (Mia / Geo / Lux)

70					80				
L (cm)	Standard	Nat. Made	Season	RaL/NCS	L (cm)	Standard	Nat. Made	Season	RaL/NCS
100	£ 658	£ 715	£ 715	£ 772	100	£ 708	£ 770	£ 770	£ 833
120	£ 681	£ 741	£ 741	£ 802	120	£ 752	£ 820	£ 820	£ 886
140	£ 752	£ 820	£ 820	£ 886	140	£ 841	£ 916	£ 916	£ 992
150	£ 803	£ 874	£ 874	£ 946	150	£ 894	£ 953	£ 953	£ 1056
160	£ 823	£ 896	£ 896	£ 970	160	£ 962	£ 1052	£ 1052	£ 1138
170	£ 911	£ 994	£ 994	£ 1076	170	£ 992	£ 1082	£ 1082	£ 1172
180	£ 946	£ 1033	£ 1033	£ 1118	180	£ 1021	£ 1115	£ 1115	£ 1209
200	£ 1011	£ 1103	£ 1103	£ 1194	200	£ 1086	£ 1186	£ 1186	£ 1286



Arq Zero blanco 200x100 cm

Colours

Standard



Naturally Made

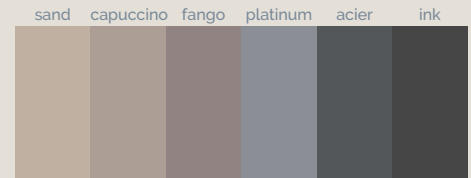

Season

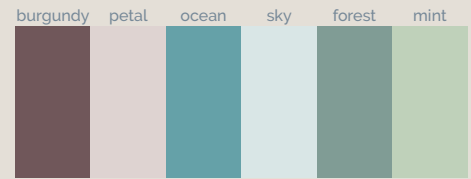

Ra/NCS







90	L (cm)	Standard	Nat. Made	Season	Ra/NCS	100	L (cm)	Standard	Nat. Made	Season	Ra/NCS
	100	£723	£787	£787	£850		100	£777	£847	£847	£916
	120	£778	£848	£848	£917		120	£850	£928	£928	£1005
	140	£862	£940	£940	£1018		140	£963	£1051	£1051	£1138
	160	£1028	£1124	£1124	£1219		160	£1203	£1315	£1315	£1427
	180	£1203	£1315	£1315	£1427		180	£1392	£1523	£1523	£1654
	200	£1402	£1536	£1536	£1667		200	£1425	£1560	£1560	£1694

90	L (cm)	Standard	Nat. Made	Season	Ra/NCS	100	L (cm)	Standard	Nat. Made	Season	Ra/NCS
	100	£759	£826	£826	£892		100	£815	£889	£889	£961
	120	£816	£890	£890	£962		120	£892	£974	£974	£1055
	140	£905	£987	£987	£1068		140	£1011	£1103	£1103	£1194
	160	£1079	£1180	£1180	£1279		160	£1263	£1380	£1380	£1498
	180	£1263	£1380	£1380	£1498		180	£1461	£1599	£1599	£1736
	200	£1472	£1612	£1612	£1750		200	£1496	£1638	£1638	£1778

NOTE: only one model of grid per shower tray is included, to choose between: Mia, Geo or Lux.

ARQ ZEROCOMPLEMENTS

Grid

		Texture	Sizes (cm)	Price	Standard	Nat. Made	Season	RaL/NCS
	Mia stainless steel grid	-	12 x 12	£ 25	✓	✓	✓	✓
	Mia Akron grid	Zero	12 x 12	£ 70	✓	✓	✓	✓
	Geo Akron grid	Zero	12 x 12	£ 70	✓	✓	✓	✓
	Lux Akron grid	Zero	12 x 12	£ 70	✓	✓	✓	✓

NOTE: only one model of grid per shower tray is included, to choose between: Mia, Geo or Lux.

Traps (mm)

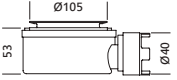

					Price
	Standard trap			✓	-
	Vertical trap			✓	-
	Extraflat trap			🛒	£ 59
	High flow trap			🛒	£ 76

NOTE: only one model of trap per shower tray is included.

Skirt

		Texture	Sizes (cm)		Standard	Nat. Made	Season	RaL/NCS
	Skirt	Zero	60 - 200 x 9 x 1,6	🛒	£ 1,30 cm linear	£ 1,37 cm linear	£ 1,37 cm linear	£ 1,42 cm linear

Installation materials

					Price
	Basic waterproofing set		Kerdi-TS Schlüter Systems	🛒	£ 259
	Adhesive glue		Ultrabond MS Rapid	🛒	£ 27
	Joint sealant		Mapesil AC	🛒	£ 19

ARQ ZERO TECHNICAL INFORMATION

Sizes

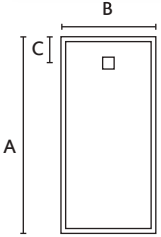
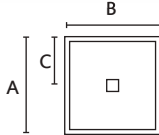
							
A (cm)	B (cm)	C (cm)	A (cm)	B (cm)	C (cm)		
100	70/80/90	25	100	100	50		
120	70/80/90/100	25					
140	70/80/90/100	25					
150	70/80	25					
160	70/80/90/100	25					
170	70/80	25					
180	70/80/90/100	25					
200	70/80/90/100	25					

Tests

Texture	Test	Result
ZERO	UNE-EN 16165:2022 Annex A	CLASS C
	French normative XP P 05-010	PN 24

Product data sheet



Installation manual





Unic Slate

Inspired by the Neo Art Deco movement, Acquabella presents the Unic shower tray. Our original Unic slate typifies this avant-garde decorative style with its geometric shapes and luxurious materials. The Unic shower tray features an elegant, gently sloping arch which frames a modern grid, all in an elegant Slate texture.



Standard sizes (cm)

70 x

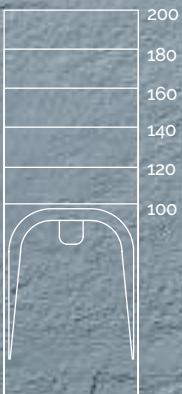

80 x

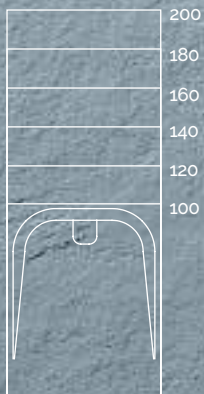

90 x

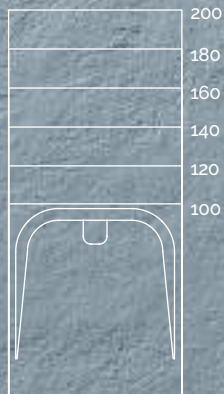

100 x

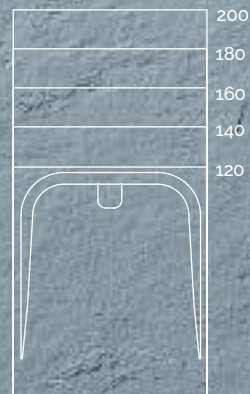

Available grids

Deco



Dune



Drop



Unic Slate

The Unic shower tray is here to break every rule thanks to its three innovative grid designs: Deco, Dune and Drop. That choice allows us to go one more step in tailoring a shower tray for you to achieve your desired effect.

Deco



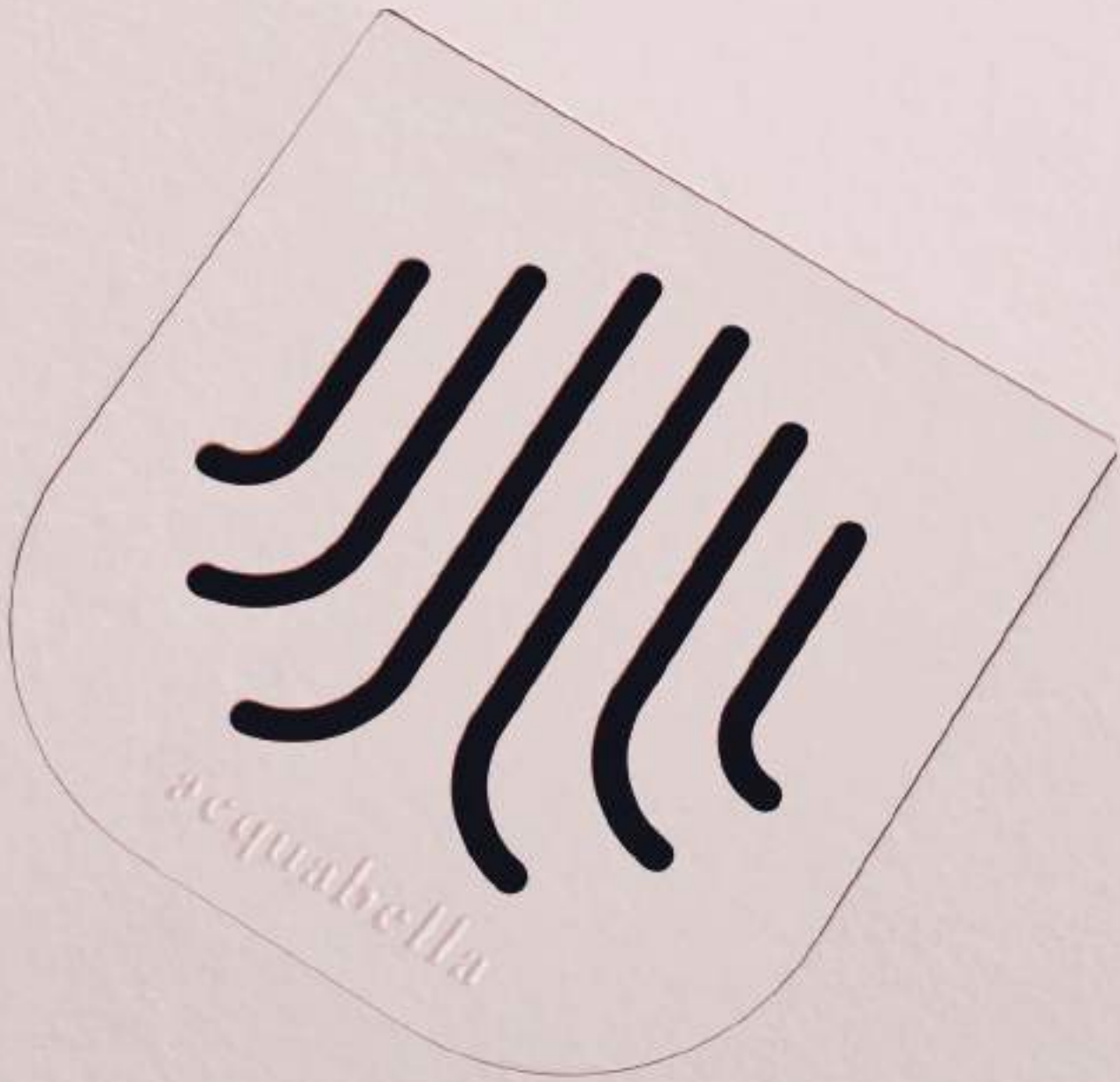

Unic Deco Slate petal 160x90 cm

Dune

Drop

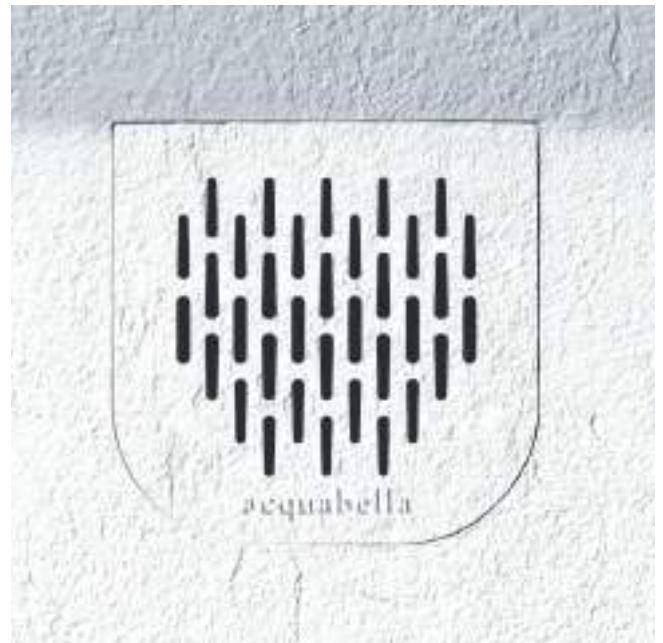





Unic Slate



Price list

70	L (cm)	Standard	Nat. Made	Season	RaI/NCS	80	L (cm)	Standard	Nat. Made	Season	RaI/NCS
	80 - 100	£ 606	£ 659	£ 659	£ 711		80 - 100	£ 623	£ 677	£ 677	£ 731
	101 - 120	£ 656	£ 713	£ 713	£ 770		101 - 120	£ 721	£ 785	£ 785	£ 848
	121 - 140	£ 721	£ 785	£ 785	£ 848		121 - 140	£ 803	£ 875	£ 875	£ 947
	141 - 160	£ 786	£ 857	£ 857	£ 928		141 - 160	£ 922	£ 1007	£ 1007	£ 1091
	161 - 180	£ 901	£ 983	£ 983	£ 1065		161 - 180	£ 978	£ 1067	£ 1067	£ 1156
	181 - 200	£ 967	£ 1055	£ 1055	£ 1144		181 - 200	£ 1038	£ 1134	£ 1134	£ 1229



Unic Drop Slate NCS S 5540-R90B 200x100 cm

Colours

Standard

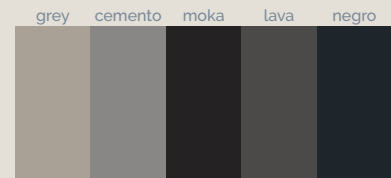
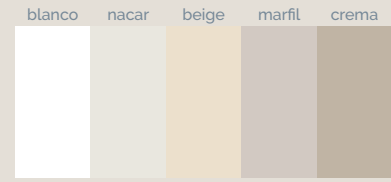

Naturally Made

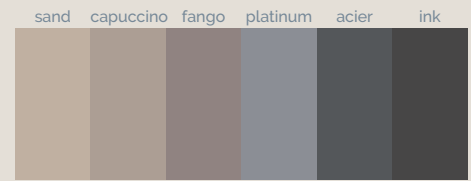

Season

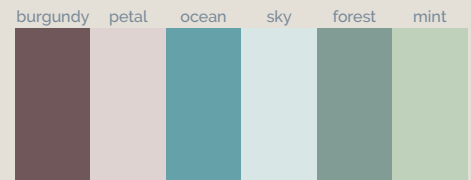

Ra/NCS





90					100				
L (cm)	Standard	Nat. Made	Season	Ra/NCS	L (cm)	Standard	Nat. Made	Season	Ra/NCS
80 - 100	£ 661	£ 718	£ 718	£ 776	101 - 120	£ 852	£ 930	£ 930	£ 1006
101 - 120	£ 781	£ 850	£ 850	£ 920	121 - 140	£ 967	£ 1055	£ 1055	£ 1144
121 - 140	£ 863	£ 941	£ 941	£ 1019	141 - 160	£ 1207	£ 1320	£ 1320	£ 1432
141 - 160	£ 1033	£ 1127	£ 1127	£ 1222	161 - 180	£ 1393	£ 1524	£ 1524	£ 1655
161 - 180	£ 1207	£ 1320	£ 1320	£ 1432	181 - 200	£ 1655	£ 1812	£ 1812	£ 1970
181 - 200	£ 1403	£ 1536	£ 1536	£ 1668					

NOTE: only one model of grid per shower tray is included, to choose between: Deco, Dune or Drop.

UNIC SLATECOMPLEMENTS

Grid

		Texture	Sizes (cm)	Price	Standard	Nat. Made	Season	Ra/NCS
	Deco Akron grid	Slate	12,1 x 12	£ 70	✓	✓	✓	✓
	Dune Akron grid	Slate	12,1 x 12	£ 70	✓	✓	✓	✓
	Drop Akron grid	Slate	12,1 x 12	£ 70	✓	✓	✓	✓

NOTE: only one model of grid per shower tray is included, to choose between: Deco, Dune or Drop.

Traps (mm)

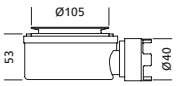
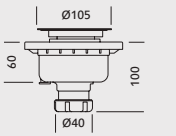
							Price
	Standard trap					✓	-
	Vertical trap					✓	-
	Extraflat trap					🛒	£ 59
	High flow trap					🛒	£ 76

NOTE: only one model of trap per shower tray is included.

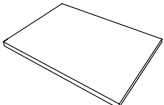

Drying area

		Texture	Sizes (cm)		Standard	Nat. Made	Season	Ra/NCS
	Drying area	Slate	100 x 100 x 2,3	🛒	£ 618	£ 679	£ 679	£ 741

Skirt

		Texture	Sizes (cm)		Standard	Nat. Made	Season	Ra/NCS
	Skirt	Slate	60 - 200 x 9 x 1,6	🛒	£ 1,30 cm linear	£ 1,37 cm linear	£ 1,37 cm linear	£ 1,42 cm linear

Installation materials

						Price
	Basic waterproofing set		Kerdi-TS Schlüter Systems		🛒	£ 259
	Adhesive glue		Ultrabond MS Rapid		🛒	£ 27
	Joint sealant		Mapesil AC		🛒	£ 19

Bespoke cut

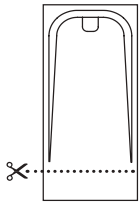

Price
£ 36

Sizes

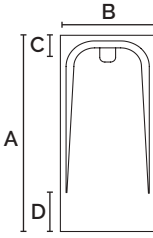
	A (cm)	B (cm)	C (cm)	D (cm)
	100	70/80/90	15,1	20
	120	70/80/90/100	15,1	20
	140	70/80/90/100	15,1	20
	160	70/80/90/100	15,1	20
	180	70/80/90/100	15,1	20
	200	70/80/90/100	15,1	20

Tests

Texture	Test	Result
SLATE	UNE-EN 16165:2022 Annex A	CLASS C
	French normative XP P 05-010	PN 24

Product data sheet



Installation manual





Halo Slate

We are enveloped by minimalism with Halo Slate, a shower tray with a framed design. It has a smooth, gently falling frame, which creates a subtle contrast with the definition of the slate. The Halo Slate shower tray is crowned with a rectangular grid integrated into the frame for rapid drainage.

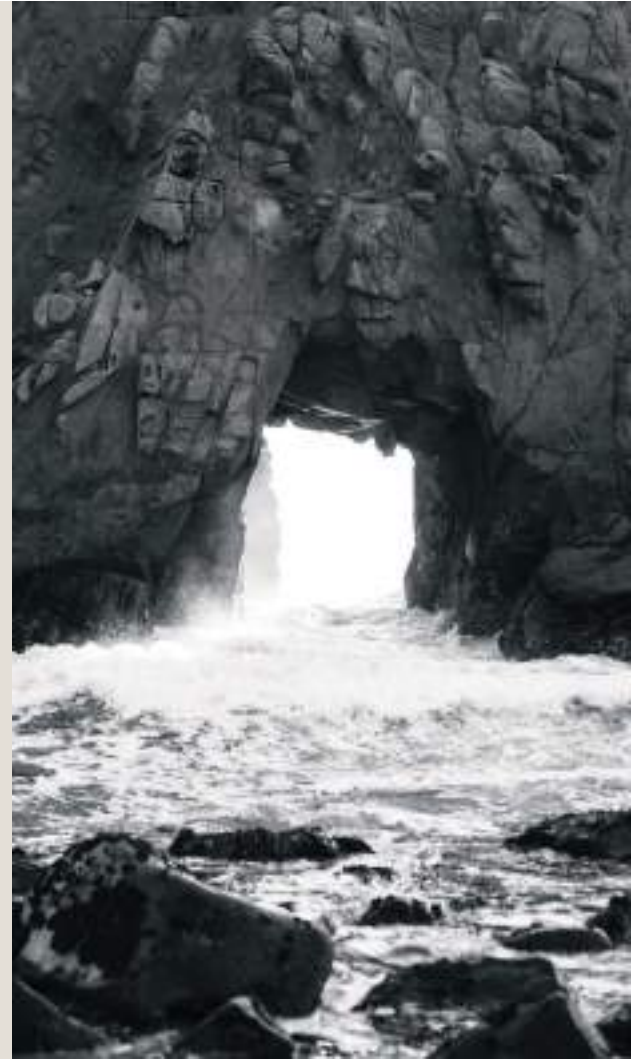

Standard sizes (cm)

70 x

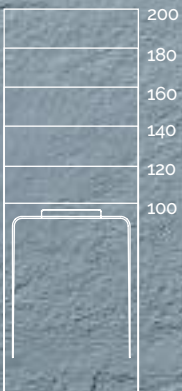

80 x

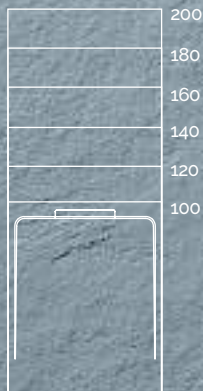

90 x

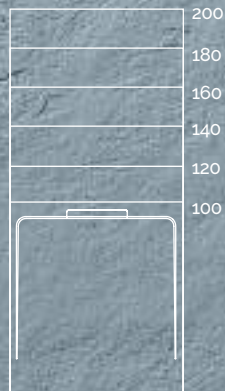

100 x

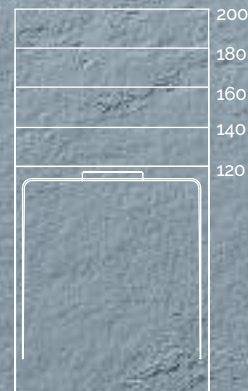

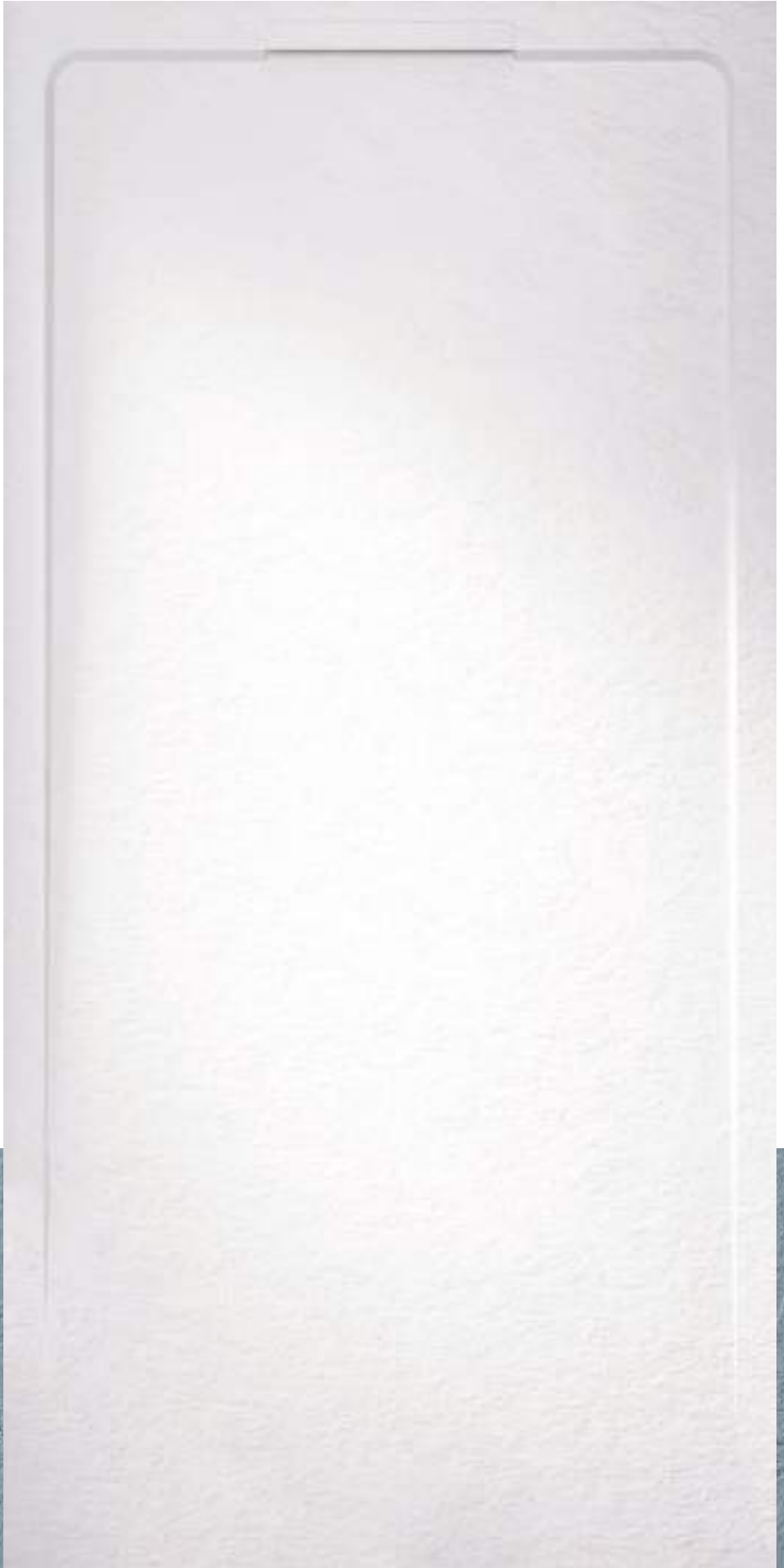





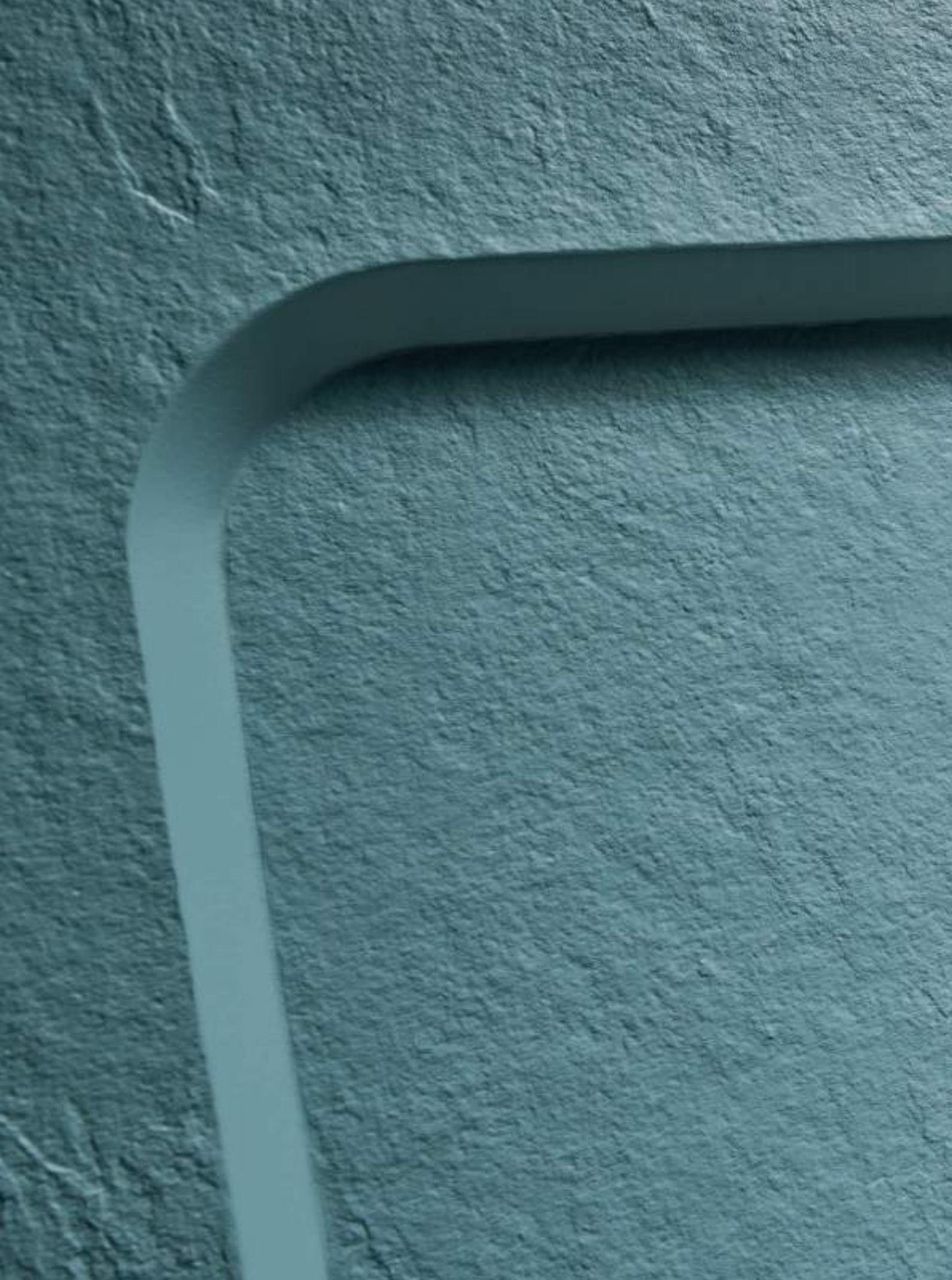









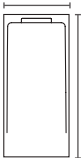
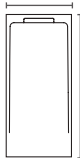

Halo Slate



Price list

70	L (cm)	Standard	Nat. Made	Season	RaI/NCS	80	L (cm)	Standard	Nat. Made	Season	RaI/NCS
	80 - 100	£ 683	£ 743	£ 743	£ 804		80 - 100	£ 700	£ 763	£ 763	£ 825
	101 - 120 	£ 734	£ 800	£ 800	£ 864		101 - 120 	£ 801	£ 873	£ 873	£ 945
	121 - 140 	£ 801	£ 873	£ 873	£ 945		121 - 140 	£ 890	£ 971	£ 971	£ 1052
	141 - 160 	£ 873	£ 952	£ 952	£ 1031		141 - 160 	£ 997	£ 1087	£ 1087	£ 1179
	161 - 180 	£ 1002	£ 1094	£ 1094	£ 1185		161 - 180 	£ 1074	£ 1173	£ 1173	£ 1273
	181 - 200	£ 1062	£ 1161	£ 1161	£ 1259		181 - 200	£ 1141	£ 1246	£ 1246	£ 1352



Halo Slate negro 200x100 cm

Colours

Standard

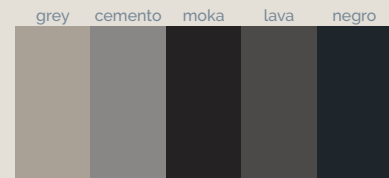
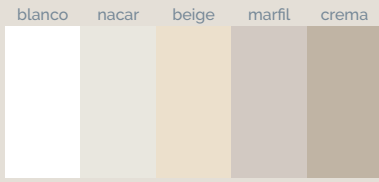

Naturally Made

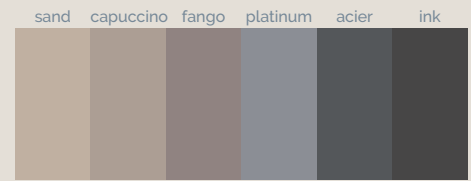

Season

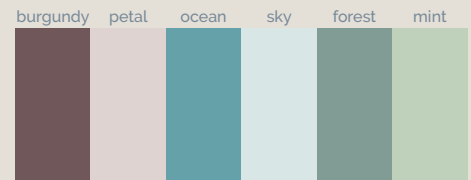





Ra/NCS



90					100				
L (cm)	Standard	Nat. Made	Season	Ra/NCS	L (cm)	Standard	Nat. Made	Season	Ra/NCS
80 - 100	£ 739	£ 805	£ 805	£ 871	101 - 120	£ 940	£ 1025	£ 1025	£ 1112
101 - 120	£ 867	£ 947	£ 947	£ 1024	121 - 140	£ 1062	£ 1161	£ 1161	£ 1259
121 - 140	£ 968	£ 1057	£ 1057	£ 1145	141 - 160	£ 1320	£ 1443	£ 1443	£ 1566
141 - 160	£ 1135	£ 1241	£ 1241	£ 1346	161 - 180	£ 1520	£ 1664	£ 1664	£ 1808
161 - 180	£ 1320	£ 1443	£ 1443	£ 1566	181 - 200	£ 1554	£ 1701	£ 1701	£ 1847
181 - 200	£ 1525	£ 1670	£ 1670	£ 1814					

HALO SLATECOMPLEMENTS

Cover

		Texture	Sizes (cm)	Standard	Nat. Made	Season	RaL/NCS
	Akron cover	Slate	31,2 x 3,5				

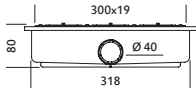

Trap (mm)



Line standard trap

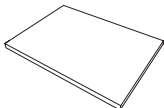

Drying area

		Texture	Sizes (cm)		Standard	Nat. Made	Season	RaL/NCS
	Drying area	Slate	100 x 100 x 2,3		£ 618	£ 679	£ 679	£ 741



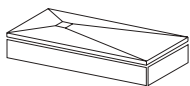



Skirt



Skirt

		Texture	Sizes (cm)		Standard	Nat. Made	Season	RaL/NCS
	Skirt	Slate	60 - 200 x 9 x 1,6		£ 1,30 cm linear	£ 1,37 cm linear	£ 1,37 cm linear	£ 1,42 cm linear

Installation materials

					Price
	Basic waterproofing set		Kerdi-TS Schlüter Systems		£ 259
	Adhesive glue		Ultrabond MS Rapid		£ 27
	Joint sealant		Mapesil AC		£ 19

HALO SLATE TECHNICAL INFORMATION

Bespoke cut

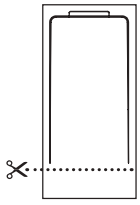

Price



£ 36

Sizes



A (cm)	B (cm)	C (cm)	D (cm)	E (cm)
100	70/80	4,4	20	40
100	90	4,4	20	50
120	70/80	4,4	20	40
120	90/100	4,4	20	50
140	70/80	4,4	20	40
140	90/100	4,4	20	50
160	70/80	4,4	20	40
160	90/100	4,4	20	50
180	70/80	4,4	20	40
180	90/100	4,4	20	50
200	70/80	4,4	20	40
200	90/100	4,4	20	50

Tests

Texture	Test	Result
SLATE	UNE-EN 16165:2022 Annex A	CLASS C
	French normative XP P 05-010	PN 24

Product data sheet



Installation manual





Areia Slate Evo

Inspired by the way the sea wears rock, Acquabella has launched its Areia Slate Evo made-to-measure shower tray. Its simple design takes the shower experience to another level thanks to the Slate Evo texture, a re-imagining of the traditional Slate texture that progressively falls away to the grid.



Standard sizes (cm)

70 x

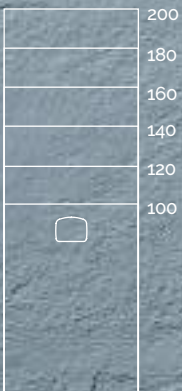

80 x

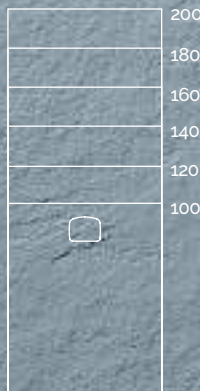

90 x

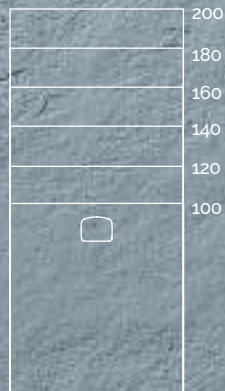

100 x

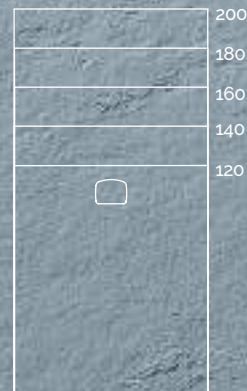



Areia Slate Evo

The Areia model has a rectangular grid with rounded edges that fits perfectly with the gentle slope of the shower tray.





Areia Slate Evo marfil 180x90 cm

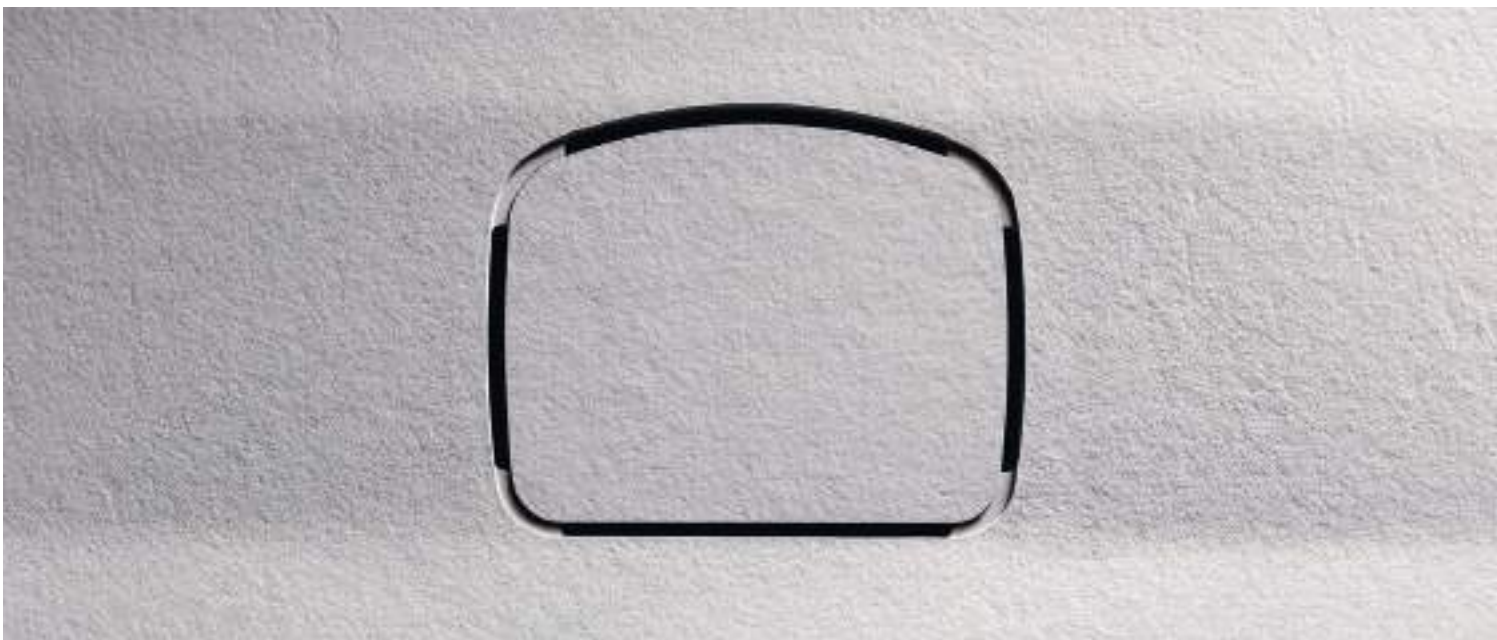

Areia Slate Evo marfil 180x90 cm 87





Areia Slate Evo



Price list

70	L (cm)	Standard	Nat. Made	Season	RaI/NCS	80	L (cm)	Standard	Nat. Made	Season	RaI/NCS
	80 - 100	£ 606	£ 659	£ 659	£ 711		80 - 100	£ 623	£ 677	£ 677	£ 731
	101 - 120	£ 656	£ 713	£ 713	£ 770		101 - 120	£ 721	£ 785	£ 785	£ 848
	121 - 140	£ 721	£ 785	£ 785	£ 848		121 - 140	£ 803	£ 875	£ 875	£ 947
	141 - 160	£ 786	£ 857	£ 857	£ 928		141 - 160	£ 922	£ 1007	£ 1007	£ 1091
	161 - 180	£ 901	£ 983	£ 983	£ 1065		161 - 180	£ 978	£ 1067	£ 1067	£ 1156
	181 - 200	£ 967	£ 1055	£ 1055	£ 1144		181 - 200	£ 1038	£ 1134	£ 1134	£ 1229

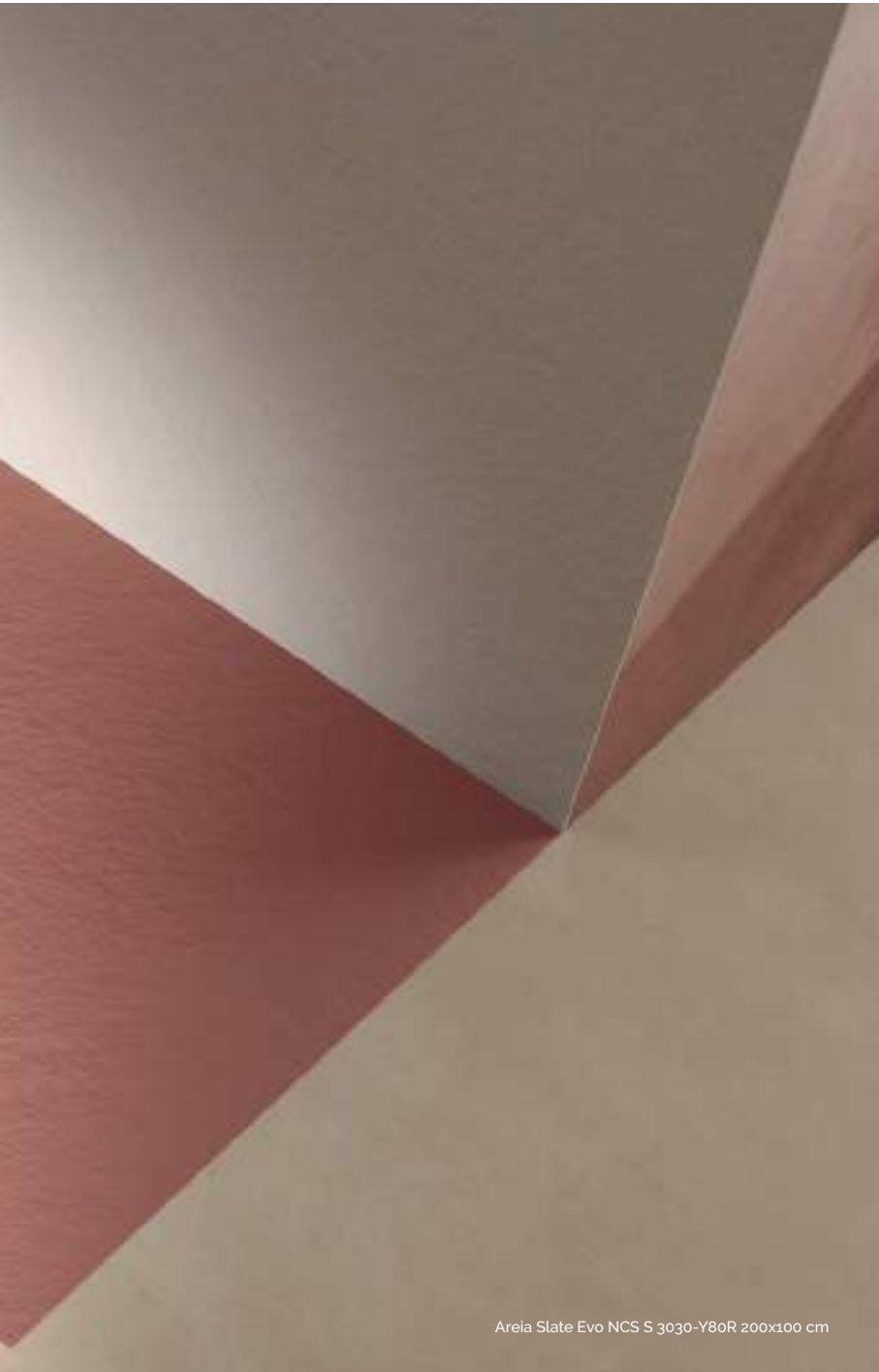

Areia Slate Evo NCS S 3030-Y80R 200x100 cm

Colours

Standard

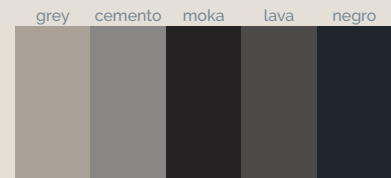
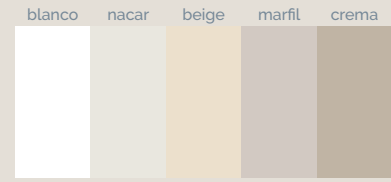

Naturally Made

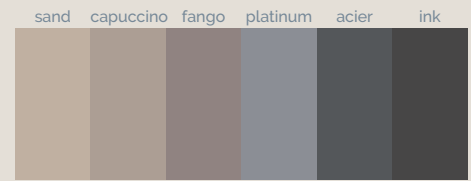

Season

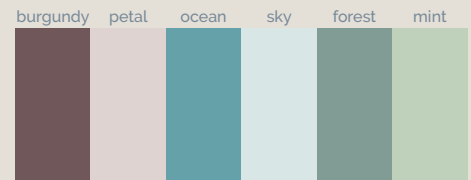





Ra/NCS



90					100							
	L (cm)	Standard	Nat. Made	Season	Ra/NCS		L (cm)	Standard	Nat. Made	Season	Ra/NCS	
	80 - 100	£ 661	£ 718	£ 718	£ 776		101 - 120	£ 852	£ 930	£ 930	£ 1006	
	101 - 120	£ 781	£ 850	£ 850	£ 920		121 - 140	£ 967	£ 1055	£ 1055	£ 1144	
	121 - 140	£ 863	£ 941	£ 941	£ 1019		141 - 160	£ 1207	£ 1320	£ 1320	£ 1432	
	141 - 160	£ 1033	£ 1127	£ 1127	£ 1222		161 - 180	£ 1393	£ 1524	£ 1524	£ 1655	
	161 - 180	£ 1207	£ 1320	£ 1320	£ 1432		181 - 200	£ 1655	£ 1812	£ 1812	£ 1970	
	181 - 200	£ 1403	£ 1544	£ 1544	£ 1684							

AREIA SLATE EVOCOMPLEMENTS

Cover



		Texture	Sizes (cm)	Standard	Nat. Made	Season	Ra/NCS
	Akron cover	Slate Evo	16 x 12,5				

Traps (mm)





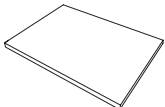

						Price
	Standard trap					-
	Vertical trap					-
	Extraflat trap					£ 59
	High flow trap					£ 76

NOTE: only one model of trap per shower tray is included.

Drying area

		Texture	Sizes (cm)	Standard	Nat. Made	Season	Ra/NCS	
	Drying area	Slate	100 x 100 x 2,3		£ 618	£ 679	£ 679	£ 741

Installation materials

						Price
	Basic waterproofing set		Kerdi-TS Schlüter Systems			£ 259
	Adhesive glue		Ultrabond MS Rapid			£ 27
	Joint sealant		Mapesil AC			£ 19

AREIA SLATE EVOTECHNICAL INFORMATION

Bespoke cut

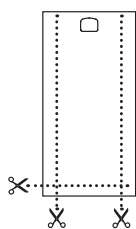

Price

£ 36

Sizes

	A (cm)	B (cm)	C (cm)
	100	70/80/90	13,1
	120	70/80/90/100	13,1
	140	70/80/90/100	13,1
	160	70/80/90/100	13,1
	180	70/80/90/100	13,1
	200	70/80/90/100	13,1

Tests

Texture	Test	Result
SLATE EVO	UNE-EN 16165:2022 Annex A	CLASS C
	French normative XPP 05-010	PN 24

Product data sheet



Installation manual





Natur Wave

Acquabella presents the new Wave texture. Its design was inspired by the dynamic patterns seen in nature. Rings of varying heights embrace and trace an irregular grid, to give our Natur model. The result is a shower tray that exudes design and personality from every side.



reddot winner 2023

Standard sizes (cm)

70 x

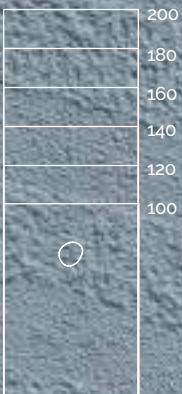

80 x

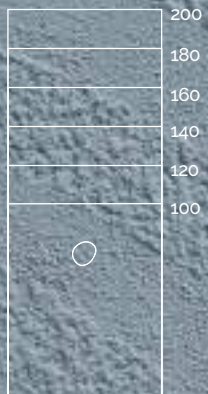

90 x

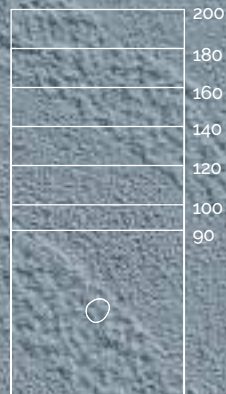

100 x

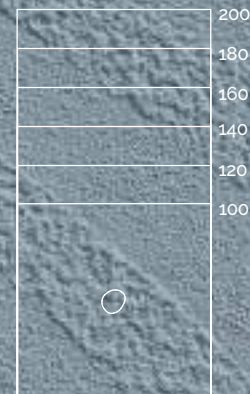

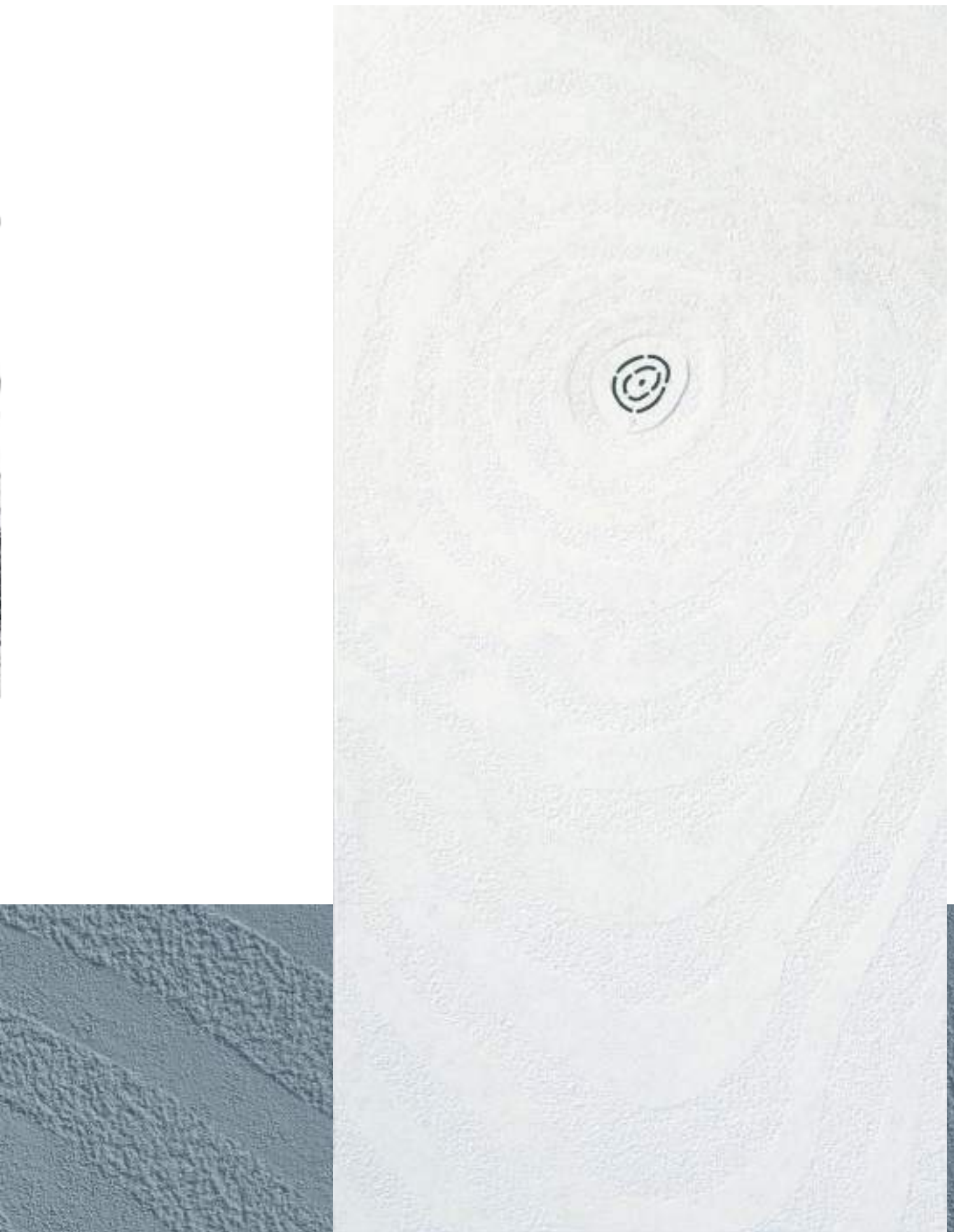









Natur Wave



Price list

70	L (cm)	Standard	Nat. Made	Season	Ra/NCS	80	L (cm)	Standard	Nat. Made	Season	Ra/NCS
	80 - 100	£606	£659	£659	£711		80 - 100	£623	£677	£677	£731
	101 - 120	£656	£713	£713	£770		101 - 120	£721	£785	£785	£848
	121 - 140	£721	£785	£785	£848		121 - 140	£803	£875	£875	£947
	141 - 160	£786	£857	£857	£928		141 - 160	£922	£1007	£1007	£1091
	161 - 180	£901	£983	£983	£1065		161 - 180	£978	£1067	£1067	£1156
	181 - 200	£967	£1055	£1055	£1144		181 - 200	£1038	£1134	£1134	£1229



Natur Wave crema 200x100 cm

Colours

Standard



Naturally Made

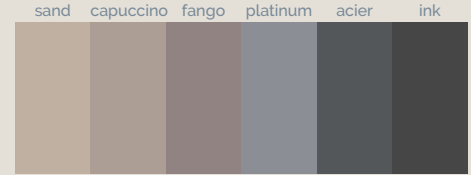

Season

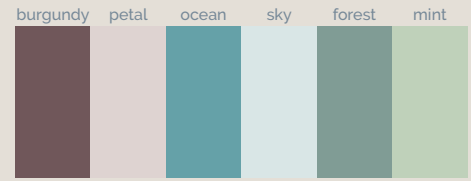

Ra/NCS



90	L (cm)	Standard				Ra/NCS	100	L (cm)	Standard				Ra/NCS
		Standard	Nat. Made	Season	Ra/NCS				Standard	Nat. Made	Season	Ra/NCS	
81-90	80 - 90	£595	£654	£654	£714	91-100	80 - 100	£734	£808	£808	£881		
	80 - 100	£661	£718	£718	£776		101 - 120	£852	£930	£930	£1006		
	101 - 120	£781	£850	£850	£920		121 - 140	£967	£1055	£1055	£1144		
	121 - 140	£863	£941	£941	£1019		141 - 160	£1207	£1320	£1320	£1432		
	141 - 160	£1033	£1127	£1127	£1222		161 - 180	£1393	£1524	£1524	£1655		
	161 - 180	£1207	£1320	£1320	£1432		181 - 200	£1655	£1812	£1812	£1970		
	181 - 200	£1403	£1536	£1536	£1668								

NATUR WAVECOMPLEMENTS

Grid







		Texture	Sizes (cm)	Standard	Nat. Made	Season	Ra/NCS
	Akron grid	Wave	14 x 13,9				

Traps (mm)

					Price
	Standard trap				-
	Vertical trap				-
	Extraflat trap				£ 59
	High flow trap				£ 76

NOTE: only one model of trap per shower tray is included.

Installation materials

				Price
	Basic waterproofing set	Kerdi-TS Schlüter Systems		£ 259
	Adhesive glue	Ultrabond MS Rapid		£ 27
	Joint sealant	Mapesil AC		£ 19

Bespoke cut

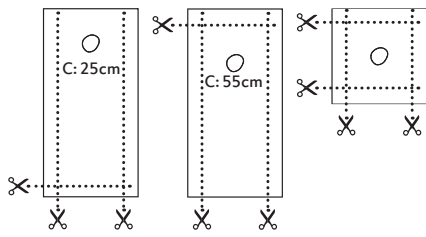

Price
£ 36

Sizes

	A (cm)	B (cm)	C (cm)		A (cm)	B (cm)	C (cm)	
	100	70/80/90	25		90	90	45	
	120	70/80/90/100	25		100	100	50	
	140	70/80/90/100	55					
	160	70/80/90/100	55					
	180	70/80/90/100	55					
	200	70/80/90/100	55					

Tests

Texture	Test	Result
WAVE	UNE-EN 16165:2022 Annex A	CLASS C
	French normative XP P 05-010	PN 24

Product data sheet



Installation manual





Smart Quiz

The Smart Quiz shower tray represents the essence of Acquabella: cutting edge, creative and ground-breaking. An innovative design whose most distinctive feature is a geometric puzzle of Beton, Zero and Ethnic textures. Made-to-measure Smart Quiz shower trays have a central grid which is totally integrated into the lines of the shower tray to hide the drain.



Standard sizes (cm)

70 x

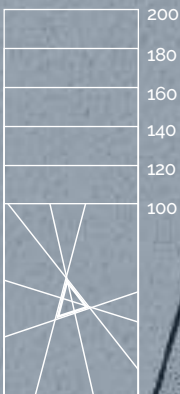

80 x

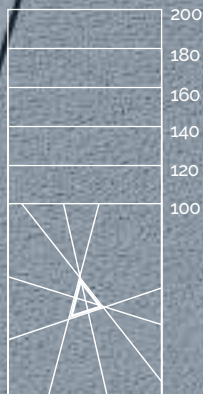

90 x

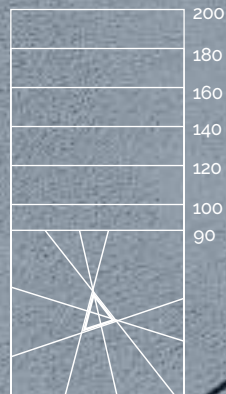

100 x

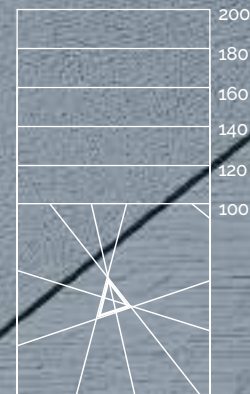

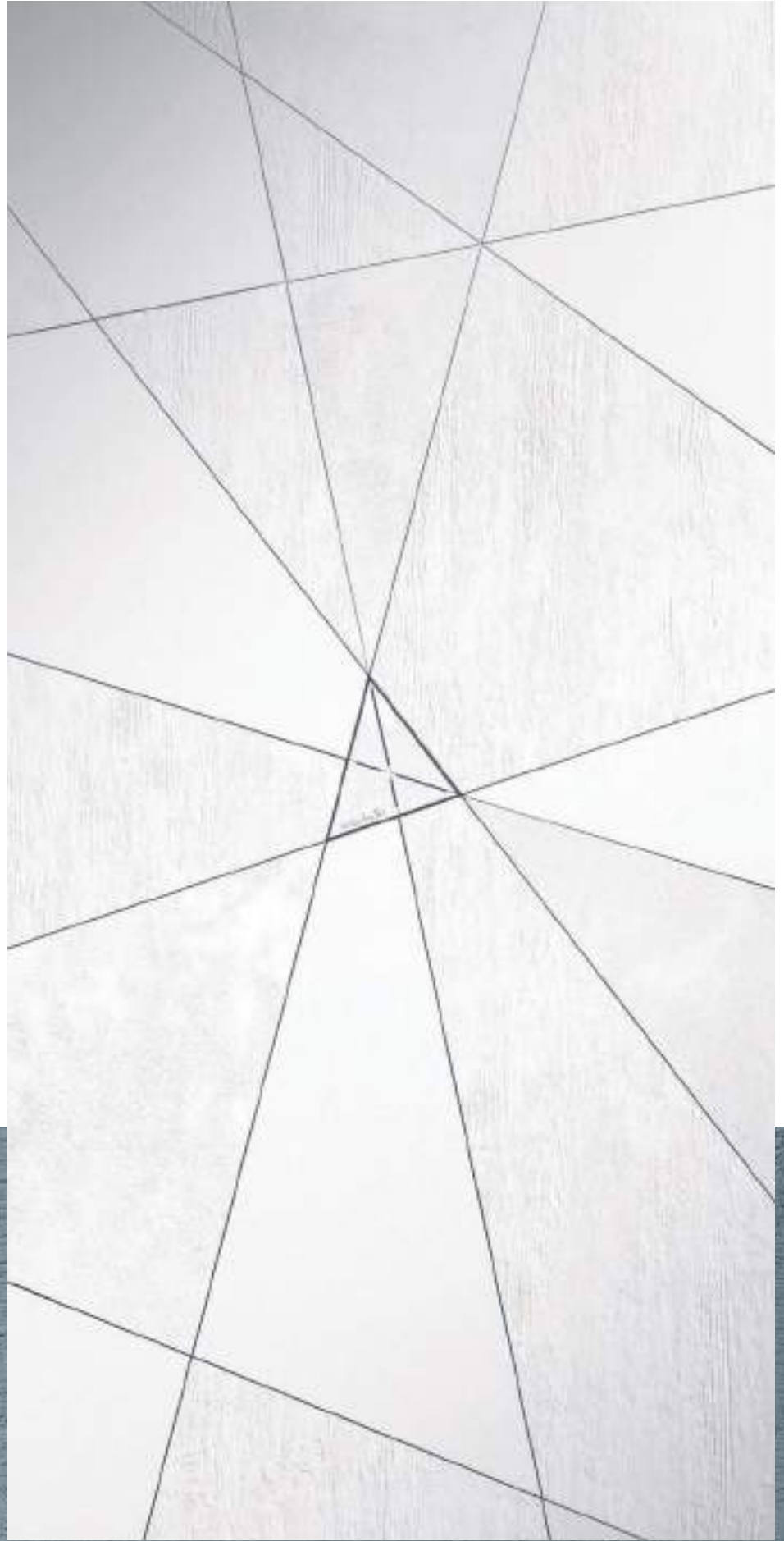





Smart Quiz

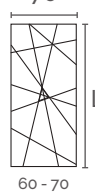
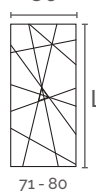

Price list

70	L (cm)	Standard	Nat. Made	Season	Ra/NCS	80	L (cm)	Standard	Nat. Made	Season	Ra/NCS
	80 - 100	£751	£818	£818	£885		80 - 100	£769	£838	£838	£907
	101 - 120	£807	£879	£879	£952		101 - 120	£881	£962	£962	£1041
	121 - 140	£881	£962	£962	£1041		121 - 140	£981	£1071	£1071	£1161
	141 - 160	£962	£1050	£1050	£1137		141 - 160	£1097	£1199	£1199	£1301
	161 - 180	£1105	£1207	£1207	£1309		161 - 180	£1184	£1294	£1294	£1404
	181 - 200	£1172	£1281	£1281	£1391		181 - 200	£1258	£1377	£1377	£1493



Smart Quiz negro 200x100 cm

Colours

Standard



Naturally Made

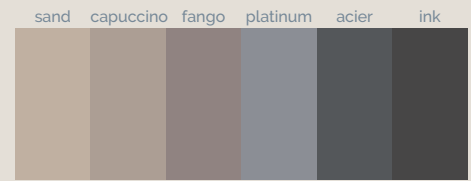

Season

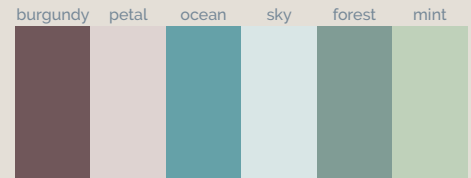

Ra/NCS



90	L (cm)	Standard	Nat. Made	Season	Ra/NCS
<p>81 - 90</p>	80 - 90	£ 808	£ 881	£ 881	£ 953
	80 - 100	£ 812	£ 885	£ 885	£ 958
	101 - 120	£ 954	£ 1042	£ 1042	£ 1129
	121 - 140	£ 1067	£ 1165	£ 1165	£ 1263
	141 - 160	£ 1253	£ 1369	£ 1369	£ 1487
	161 - 180	£ 1457	£ 1595	£ 1595	£ 1733
	181 - 200	£ 1686	£ 1846	£ 1846	£ 2007

100	L (cm)	Standard	Nat. Made	Season	Ra/NCS
<p>91 - 100</p>	80 - 100	£ 918	£ 1003	£ 1003	£ 1086
	101 - 120	£ 1037	£ 1131	£ 1131	£ 1227
	121 - 140	£ 1172	£ 1281	£ 1281	£ 1391
	141 - 160	£ 1457	£ 1595	£ 1595	£ 1733
	161 - 180	£ 1680	£ 1840	£ 1840	£ 2001
	181 - 200	£ 1718	£ 1881	£ 1881	£ 2044

SMART QUIZ COMPLEMENTS

Grid



		Texture	Sizes (cm)	Standard	Nat. Made	Season	Ra/NCS
	Akron grid	Beton	17,6 x 17,6	✓	✓	✓	✓

Traps (mm)

					Price
	Standard trap			✓	-
	Vertical trap			✓	-
	Extraflat trap			🛒	£ 59
	High flow trap			🛒	£ 76

NOTE: only one model of trap per shower tray is included.

Installation materials

					Price
	Basic waterproofing set	Kerdi-TS Schlüter Systems		🛒	£ 259
	Adhesive glue	Ultrabond MS Rapid		🛒	£ 27
	Joint sealant	Mapesil AC		🛒	£ 19

Bespoke cut

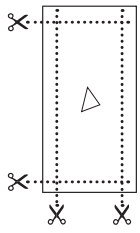

Price
£ 36

Sizes

	A (cm)	B (cm)	C (cm)
	90	90	45
	100	70/80/90/100	50
	120	70/80/90/100	60
	140	70/80/90/100	70
	160	70/80/90/100	80
	180	70/80/90/100	90
	200	70/80/90/100	100

Tests

Texture	Test	Result
QUIZ	UNE-EN 16165:2022 Annex A	CLASS B
	French normative XP P 05-010	PN 18

Product data sheet



Installation manual





Tempo Arabba

Tempo Arabba represents a return to our origins, marked by design and craftsmanship. Looking as though made from fabric, it reproduces the appearance of hand-woven natural fibres with the care that Acquabella invests in every product. Its patterning plays with our visual perception, merging with a stone finish. A texture true to our desire to be different.



Standard sizes (cm)

70 x

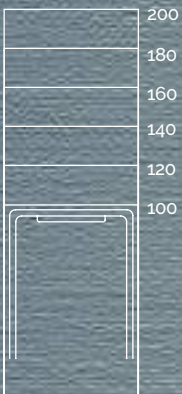

80 x

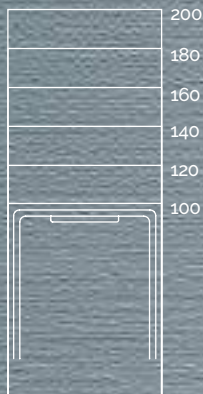

90 x

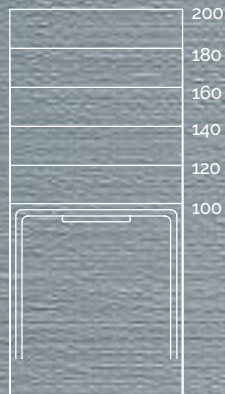

100 x

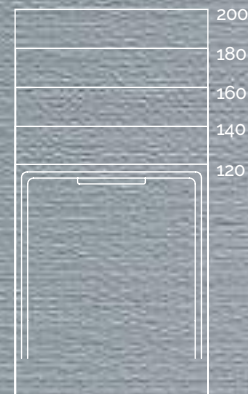







Tempo Arabba



Price list

70	L (cm)	Standard	Nat. Made	Season	RaI/NCS	80	L (cm)	Standard	Nat. Made	Season	RaI/NCS
	80 - 100	£710	£775	£775	£836		80 - 100	£759	£830	£830	£896
	101 - 120	£759	£830	£830	£896		101 - 120	£830	£907	£907	£983
	121 - 140	£830	£907	£907	£983		121 - 140	£929	£1016	£1016	£1097
	141 - 160	£939	£1026	£1026	£1114		141 - 160	£1033	£1130	£1130	£1223
	161 - 180	£1038	£1136	£1136	£1229		161 - 180	£1119	£1223	£1223	£1327
	181 - 200	£1109	£1213	£1213	£1316		181 - 200	£1185	£1299	£1299	£1410



Tempo Arabba blanco 200x100 cm

Colours

Standard

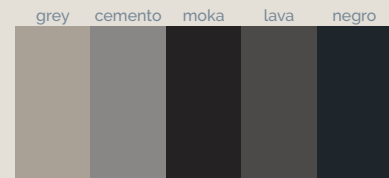
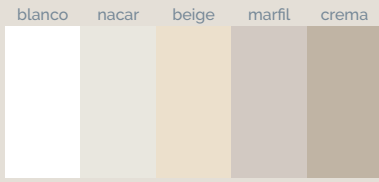

Naturally Made

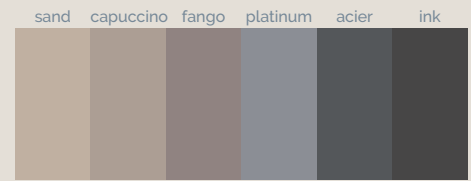

Season

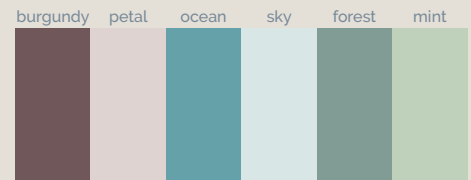





Ra/NCS



90						100						
	L (cm)	Standard	Nat. Made	Season	Ra/NCS		L (cm)	Standard	Nat. Made	Season	Ra/NCS	
	80 - 100	£ 813	£ 890	£ 890	£ 962		101 - 120	£ 978	£ 1071	£ 1071	£ 1158	
	101 - 120	£ 901	£ 983	£ 983	£ 1065		121 - 140	£ 1109	£ 1213	£ 1213	£ 1316	
	121 - 140	£ 1038	£ 1136	£ 1136	£ 1229		141 - 160	£ 1370	£ 1502	£ 1502	£ 1633	
	141 - 160	£ 1251	£ 1370	£ 1370	£ 1486		161 - 180	£ 1590	£ 1742	£ 1742	£ 1896	
	161 - 180	£ 1370	£ 1502	£ 1502	£ 1633		181 - 200	£ 1622	£ 1780	£ 1780	£ 1934	
	181 - 200	£ 1584	£ 1737	£ 1737	£ 1884							

TEMPO ARABBA COMPLEMENTS

Cover

	Texture	Sizes (cm)	Standard	Nat. Made	Season	RaL/NCS
 Akron cover	Arabba	34,6 x 2,8				



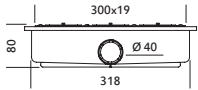

Trap (mm)





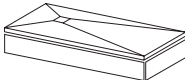



Line standard trap



Skirt

	Texture	Sizes (cm)	Standard	Nat. Made	Season	RaL/NCS
 Skirt	Arabba	60 - 200 x 9 x 1,6	 £ 1,30 cm linear	 £ 1,37 cm linear	 £ 1,37 cm linear	 £ 1,42 cm linear

Installation materials

				Price
	Basic waterproofing set	Kerdi-TS Schlüter Systems		£ 259
	Adhesive glue	Ultrabond MS Rapid		£ 27
	Joint sealant	Mapesil AC		£ 19

Bespoke cut

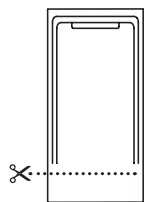

Price



£ 36

Sizes

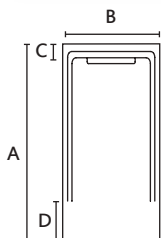

A (cm)	B (cm)	C (cm)	D (cm)
100	70/80/90	7,4	20
120	70/80/90/100	7,4	20
140	70/80/90/100	7,4	20
160	70/80/90/100	7,4	20
180	70/80/90/100	7,4	20
200	70/80/90/100	7,4	20

Tests

Texture	Test	Result
ARABBA	UNE-EN 16165:2022 Annex A	CLASS C
	French normative XP P 05-010	PN 24

Product data sheet



Installation manual





Flow Zero

The Flow Zero shower tray is designed to become one with water. Its design immerses us in a universe of calm and relaxation thanks to a refined minimalist style. Its gentle gradients, in keeping with the Zero texture, direct the water towards a grid integrated into the frame, capable of handling the large flow captured by the its surface.



Standard sizes (cm)

70 x

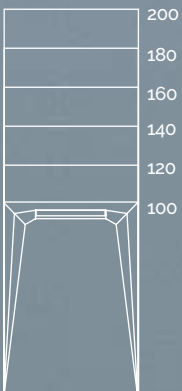

80 x



90 x

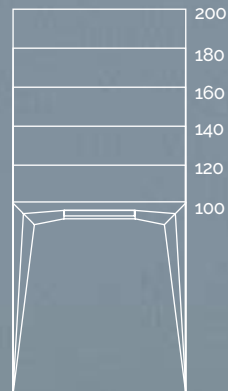

100 x

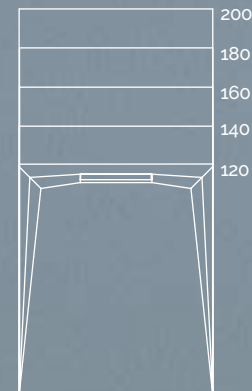







Flow Zero



Price list

70					80				
L (cm)	Standard	Nat. Made	Season	RaI/NCS	L (cm)	Standard	Nat. Made	Season	RaI/NCS
100	£ 682	£ 742	£ 742	£ 803	100	£ 732	£ 797	£ 797	£ 863
120	£ 732	£ 797	£ 797	£ 863	120	£ 797	£ 868	£ 868	£ 945
140	£ 797	£ 868	£ 868	£ 945	140	£ 890	£ 972	£ 972	£ 1054
160	£ 901	£ 983	£ 983	£ 1065	160	£ 988	£ 1081	£ 1081	£ 1174
180	£ 993	£ 1087	£ 1087	£ 1180	180	£ 1076	£ 1180	£ 1180	£ 1278
200	£ 1065	£ 1163	£ 1163	£ 1261	200	£ 1136	£ 1245	£ 1245	£ 1349



Flow Zero NCS S 4020-Rg0B 200x100 cm

Colours

Standard

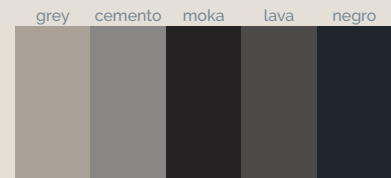
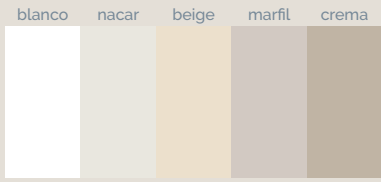

Naturally Made

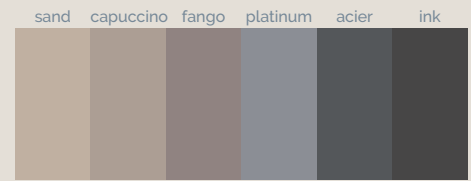

Season

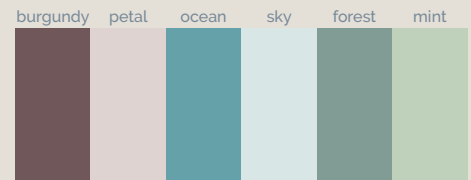





Ra/NCS



90	L (cm)	Standard				Nat. Made				Season				Ra/NCS			
		Standard	Nat. Made	Season	Ra/NCS	Standard	Nat. Made	Season	Ra/NCS	Standard	Nat. Made	Season	Ra/NCS				
100	100	£ 781	£ 852	£ 852	£ 922	£ 939	£ 1026	£ 1026	£ 1114	£ 1065	£ 1163	£ 1163	£ 1261				
	120	£ 868	£ 950	£ 950	£ 1026	£ 1316	£ 1442	£ 1442	£ 1567	£ 1524	£ 1676	£ 1676	£ 1813				
	140	£ 993	£ 1087	£ 1087	£ 1180	£ 1557	£ 1704	£ 1704	£ 1851								
	160	£ 1196	£ 1311	£ 1311	£ 1420												
	180	£ 1316	£ 1442	£ 1442	£ 1567												
	200	£ 1519	£ 1650	£ 1650	£ 1808												

FLOW ZERO COMPLEMENTS



Cover

		Texture	Sizes (cm)	Standard	Nat. Made	Season	RaL/NCS
	Akron cover	Zero	36,1 x 3				





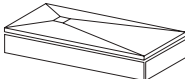

Trap (mm)

	Line standard trap						
---	--------------------	--	--	--	--	--	---

Skirt

		Texture	Sizes (cm)	Standard	Nat. Made	Season	RaL/NCS
	Skirt	Zero	60 - 200 x 9 x 1,6	 £ 1,30 cm linear	£ 1,37 cm linear	£ 1,37 cm linear	£ 1,42 cm linear

Installation materials

					Price
	Basic waterproofing set		Kerdi-TS Schlüter Systems		£ 259
	Adhesive glue		Ultrabond MS Rapid		£ 27
	Joint sealant		Mapesil AC		£ 19

FLOW ZERO TECHNICAL INFORMATION

Sizes

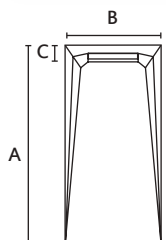

The technical drawing shows a trapezoidal shower tray with a central rectangular opening. Dimension A is the total height, B is the top width, and C is the height of the central opening.

A (cm)	B (cm)	C (cm)
100	70/80/90	5,6
120	70/80/90/100	5,6
140	70/80/90/100	5,6
160	70/80/90/100	5,6
180	70/80/90/100	5,6
200	70/80/90/100	5,6

Tests

Texture	Test	Result
ZERO	UNE-EN 16165:2022 Annex A	CLASS C
	French normative XP P 05-010	PN 24

Product data sheet



Installation manual





Focus Beton

Fashion is cyclical but geometric shapes are a constant feature of design. Acquabella wants to convey that sense of unity and perfection through its Focus shower tray. It combines Beton's cement-like texture with a ring in the metal finish of your choice for the drain to provide a harmonic mix of materials.



Standard sizes (cm)

80 x

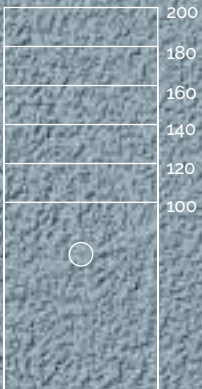

90 x

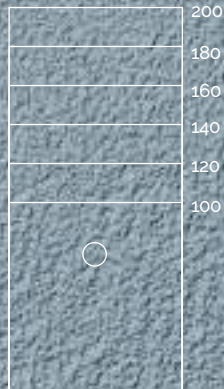

100 x

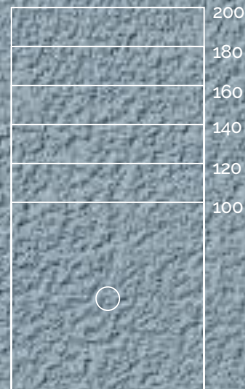

Available metal rings

Inox



Cobre



Negro



Blanco

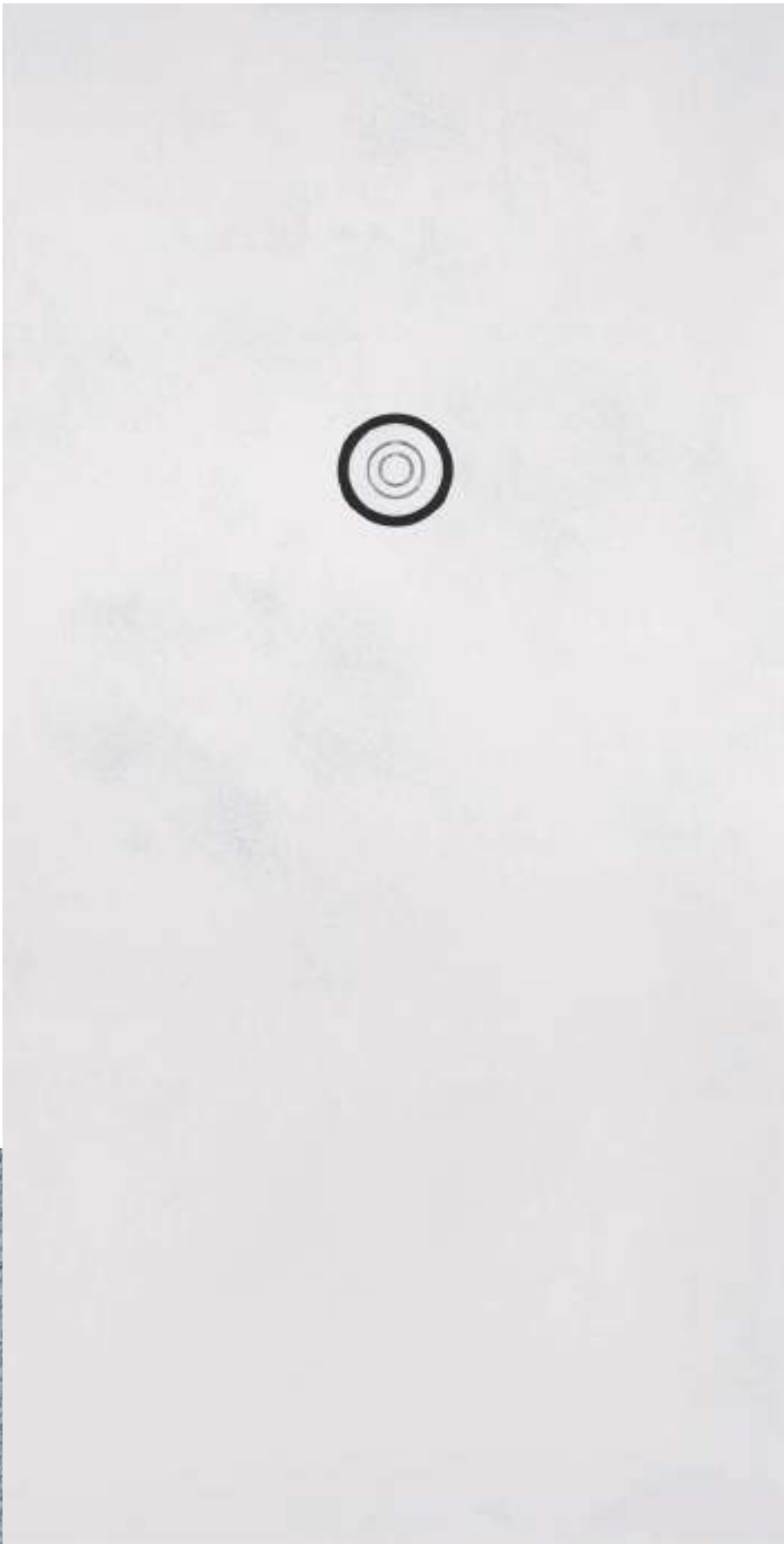





Focus Beton



Price list

80	L (cm)	Standard	Nat. Made	Season	RaI/NCS	90	L (cm)	Standard	Nat. Made	Season	RaI/NCS
 70 - 80	80 - 100	£ 623	£ 677	£ 677	£ 731	 81 - 90	80 - 100	£ 661	£ 718	£ 718	£ 776
	101 - 120	£ 721	£ 785	£ 785	£ 848		101 - 120	£ 781	£ 850	£ 850	£ 920
	121 - 140	£ 803	£ 875	£ 875	£ 947		121 - 140	£ 863	£ 941	£ 941	£ 1019
	141 - 160	£ 922	£ 1007	£ 1007	£ 1091		141 - 160	£ 1033	£ 1127	£ 1127	£ 1222
	161 - 180	£ 978	£ 1067	£ 1067	£ 1156		161 - 180	£ 1207	£ 1320	£ 1320	£ 1432
	181 - 200	£ 1038	£ 1134	£ 1134	£ 1229		181 - 200	£ 1403	£ 1536	£ 1536	£ 1668



Focus cobre Beton blanco 200x100 cm

Colours

Standard

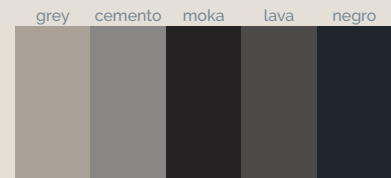
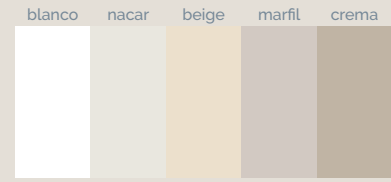

Naturally Made

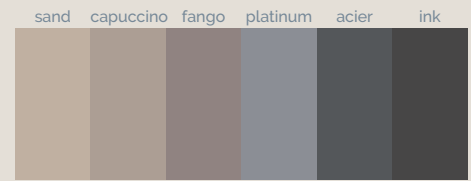

Season

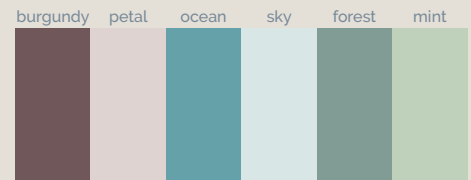











Ra/NCS



	L (cm)	Standard	Nat. Made	Season	Ra/NCS
	80 - 100	£ 748	£ 814	£ 814	£ 881
	101 - 120	£ 852	£ 930	£ 930	£ 1006
	121 - 140	£ 967	£ 1055	£ 1055	£ 1144
	141 - 160	£ 1207	£ 1320	£ 1320	£ 1432
	161 - 180	£ 1393	£ 1524	£ 1524	£ 1655
	181 - 200	£ 1655	£ 1812	£ 1812	£ 1970

FOCUS BETON COMPLEMENTS

Grid



		Texture	Sizes (cm)	Standard	Nat. Made	Season	RaL/NCS
	Akron grid	Beton	Ø 10,6				
	Metal ring	Inox / Cobre / Negro / Blanco	Ø 12,9				

Traps (mm)

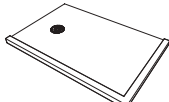

						Price
	Standard trap					-
	Vertical trap					-
	Extraflat trap					£ 59
	High flow trap					£ 76

NOTE: only one model of trap per shower tray is included.





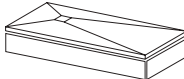

Frame

		Texture	Sizes (cm)	Standard	Nat. Made	Season	RaL/NCS
	Frame	Beton	4,1 x 5		£ 1,37 cm linear	£ 1,51 cm linear	£ 1,64 cm linear

Skirt

		Texture	Sizes (cm)	Standard	Nat. Made	Season	RaL/NCS
	Skirt	Beton	60 - 200 x 9 x 1,6		£ 1,30 cm linear	£ 1,37 cm linear	£ 1,42 cm linear

Installation materials

						Price
	Basic waterproofin set		Kerdi-TS Schlüter Systems			£ 259
	Adhesive glue		Ultrabond MS Rapid			£ 27
	Joint sealant		Mapesil AC			£ 19

Bespoke cut

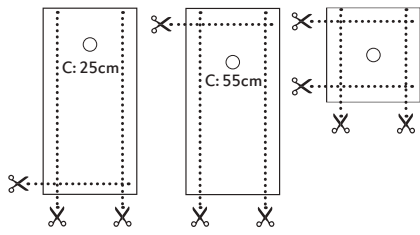

Price
£ 36

Sizes

		A (cm)	B (cm)	C (cm)			A (cm)	B (cm)	C (cm)
		100	80/90	25			100	100	50
		120	80/90/100	25					
		140	80/90/100	55					
		160	80/90/100	55					
		180	80/90/100	55					
		200	80/90/100	55					

Tests

Texture	Test	Result
BETON	UNE-EN 16165:2022 Annex A	CLASS C
	French normative XP P 05-010	PN 24

Product data sheet



Installation manual





Prisma Slate

Elegant angles are a key feature of the Prisma Slate shower tray, playing with light and shadow to add extra value to the design. Slate texture takes centre stage in this made-to-measure shower tray, which is crowned with an elongated stainless steel grid, integrated in its smooth contours.



Standard sizes (cm)

70 x

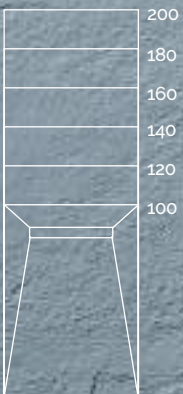

80 x

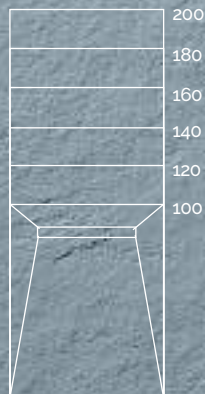

90 x

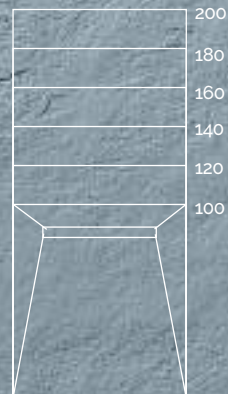

100 x

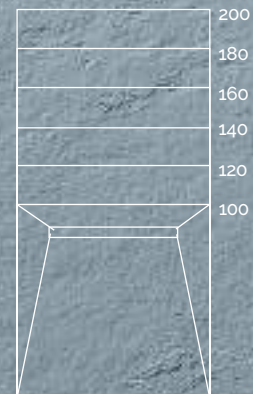



Prisma Slate



Price list

70					80						
	L (cm)	Standard	Nat. Made	Season	RaL/NCS		L (cm)	Standard	Nat. Made	Season	RaL/NCS
	80 - 100	£ 606	£ 659	£ 659	£ 711		80 - 100	£ 623	£ 677	£ 677	£ 731
	101 - 120	£ 656	£ 713	£ 713	£ 770		101 - 120	£ 721	£ 785	£ 785	£ 848
	121 - 140	£ 721	£ 785	£ 785	£ 848		121 - 140	£ 803	£ 875	£ 875	£ 947
	141 - 160	£ 786	£ 857	£ 857	£ 928		141 - 160	£ 922	£ 1007	£ 1007	£ 1091
	161 - 180	£ 901	£ 983	£ 983	£ 1065		161 - 180	£ 978	£ 1067	£ 1067	£ 1156
	181 - 200	£ 967	£ 1055	£ 1055	£ 1144		181 - 200	£ 1038	£ 1134	£ 1134	£ 1229



Prisma Slate blanco 200x100 cm

Colours

Standard

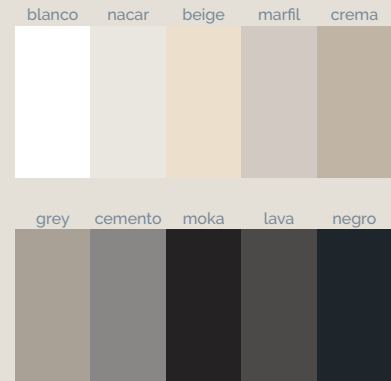

Naturally Made

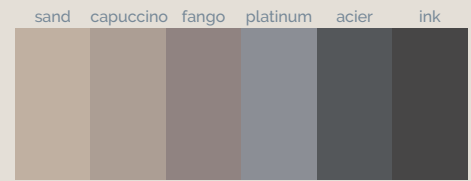

Season

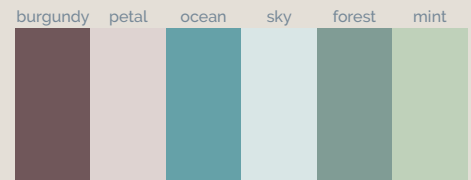

Ra/NCS



90					100						
	L (cm)	Standard	Nat. Made	Season	Ra/NCS		L (cm)	Standard	Nat. Made	Season	Ra/NCS
	80 - 100	£ 661	£ 718	£ 718	£ 776		80 - 100	£ 748	£ 814	£ 814	£ 881
	101 - 120	£ 781	£ 850	£ 850	£ 920		101 - 120	£ 852	£ 930	£ 930	£ 1006
	121 - 140	£ 863	£ 941	£ 941	£ 1019		121 - 140	£ 967	£ 1055	£ 1055	£ 1144
	141 - 160	£ 1033	£ 1127	£ 1127	£ 1222		141 - 160	£ 1207	£ 1320	£ 1320	£ 1432
	161 - 180	£ 1207	£ 1320	£ 1320	£ 1432		161 - 180	£ 1393	£ 1524	£ 1524	£ 1655
	181 - 200	£ 1403	£ 1536	£ 1536	£ 1668		181 - 200	£ 1655	£ 1812	£ 1812	£ 1970

PRISMA SLATE COMPLEMENTS

Grid

	Sizes (cm)	Standard	Nat. Made	Season	RaL/NCS
 Stainless steel grid	7 x L	<input checked="" type="checkbox"/>	<input checked="" type="checkbox"/>	<input checked="" type="checkbox"/>	<input checked="" type="checkbox"/>

Traps (mm)

 Standard Ø70 trap					<input checked="" type="checkbox"/>
 Vertical Ø70 trap					<input checked="" type="checkbox"/>

NOTE: only one model of trap per shower tray is included.

Frame

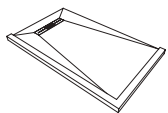
	Texture	Sizes (cm)		Standard	Nat. Made	Season	RaL/NCS
 Frame	Slate	4,1 x 5	<input type="checkbox"/>	£ 1,37 cm linear	£ 1,51 cm linear	£ 1,51 cm linear	£ 1,64 cm linear

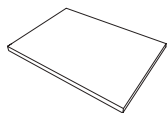

Drying area

	Texture	Sizes (cm)		Standard	Nat. Made	Season	RaL/NCS
 Drying area	Slate	100 x 100 x 2,3	<input type="checkbox"/>	£ 618	£ 679	£ 679	£ 741

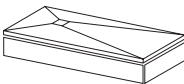
Skirt

	Texture	Sizes (cm)		Standard	Nat. Made	Season	RaL/NCS
 Skirt	Slate	60 - 200 x 9 x 1,6	<input type="checkbox"/>	£ 1,30 cm linear	£ 1,37 cm linear	£ 1,37 cm linear	£ 1,42 cm linear

Installation materials

				Price
 Basic waterproofing set		Kerdi-TS Schlüter Systems	<input type="checkbox"/>	£ 259
 Adhesive glue		Ultrabond MS Rapid	<input type="checkbox"/>	£ 27
 Joint sealant		Mapesil AC	<input type="checkbox"/>	£ 19

Bespoke cut

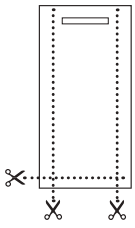

Price
£ 36

Sizes

A (cm)	B (cm)	C (cm)
100	70/80/90/100	15
120	70/80/90/100	15
140	70/80/90/100	15
160	70/80/90/100	15
180	70/80/90/100	15
200	70/80/90/100	15

Tests

Texture	Test	Result
SLATE	UNE-EN 16165:2022 Annex A	CLASS C
	French normative XP P 05-010	PN 24

Product data sheet



Installation manual







Bathtubs

Opal Quiz 144-149

Lech 150-153

Nevis 154-157

Dewa 158-161

Voss 162-165

Chrea 166-171

Levi 172-175

Vars 176-179

Venet 180-183

Boreal 184-187

Opal Quiz



Opal Quiz bathtub negro

Price list

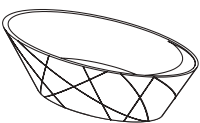
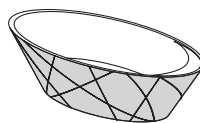
Opal Quiz	Standard	Nat. Made	Season	Ra/NCS	Opal Colors Quiz	Standard	Nat. Made	Season	Ra/NCS
	£5862	£5971	£5971	£6081		£7034	£7738	£7738	£8441

Colours

Standard

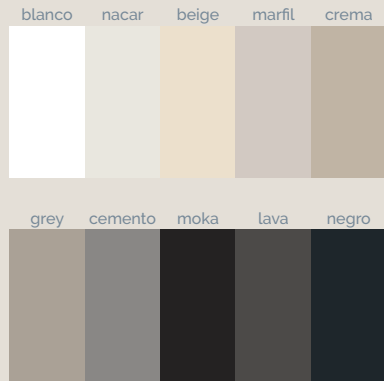

Naturally Made

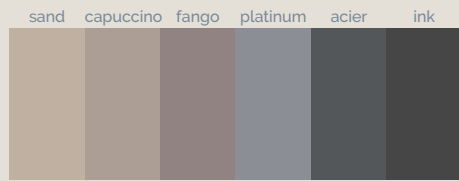

Season

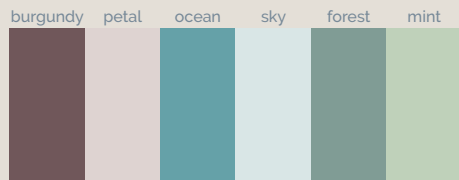

RaI/NCS



Standard sizes (cm)

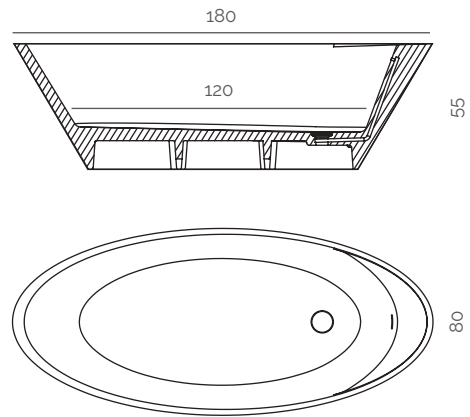

Awards







OPAL QUIZCOMPLEMENTS

Drain



Akron clic-clac drain

Finish

Chrome

Cover finish

Standard / Nat. Made /
Season / RaI/NCS



Trap (mm)

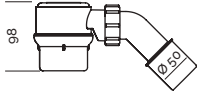

Standard trap H98



Installation materials



Joint sealant

Mapesil AC



Price

£ 19

OPAL QUIZTECHNICAL INFORMATION



Kg

Weight of the bathtub (Kg)

158



L

Water volume to overflow (L)

222

Product data
sheet



Installation
manual







Lech bathtub

Price list

Lech

Price

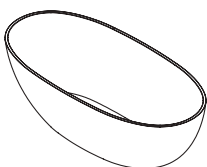

£2975



Colours

Standard

blanco mate





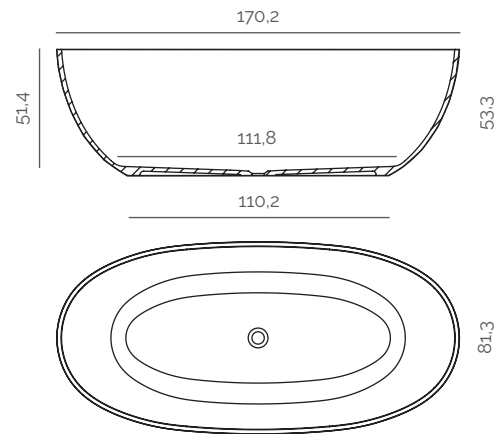

Standard sizes (cm)



LECHCOMPLEMENTS

Drain

		Finish	Cover finish		Price
	Clic-clac drain	Chrome	Blanco mate		-
	Clic-clac drain	Chrome	Chrome		£ 125

Trap (mm)



Standard trap Hg8



Installation materials



Joint sealant

Mapesil AC



Price

£ 19

LECHTECHNICAL INFORMATION



Weight of the bathtub (Kg) **86,54**



Water volume (L) **427**

Product data sheet



Installation manual







Nevis bathtub

Price list

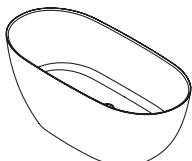
Nevis	Price
	£2610

Colours

Standard

blanco mate



Standard sizes (cm)

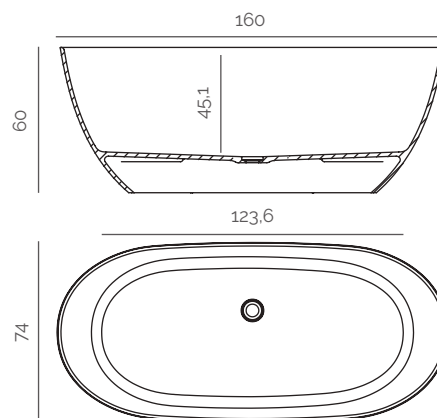

NEVISCOMPLEMENTS

Drain



Dolotek clic-clac drain

Finish

Chrome

Cover finish

Blanco mate



Trap (mm)

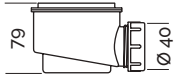

Standard trap H79



Installation materials



Joint sealant

Mapesil AC



Price

£ 19

NEVISTECHNICAL INFORMATION



Kg

Weight of the bathtub (Kg)

94,40



L

Water volume (L)

375

Product data sheet



Installation manual







Dewa bathtub

Price list

Dewa

Price

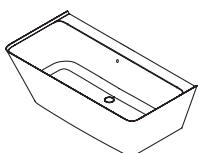

£3015



Colours

Standard

blanco mate



Standard sizes (cm)

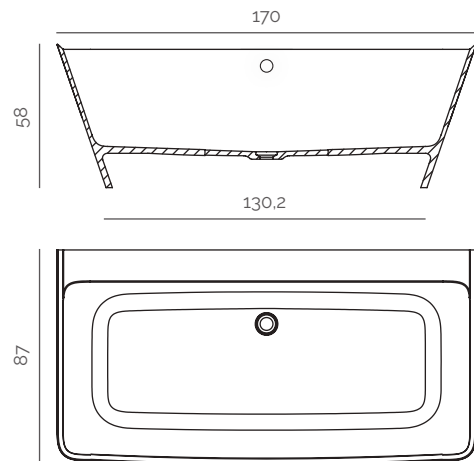

DEWACOMPLEMENTS

Drain



Dolotek clic-clac drain

Finish

Chrome

Cover finish

Blanco mate



Trap (mm)

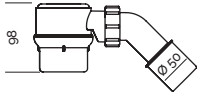

Standard trap H98



Installation materials



Joint sealant

Mapesil AC



Price

£ 19

DEWATECHNICAL INFORMATION



Kg

Weight of the bathtub (Kg)

133,11



L

Water volume to overflow (L)

263

Product data sheet



Installation manual







Voss bathtub

Price list

Voss

Price

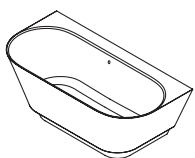

£ 2960

Colours

Standard

blanco mate



Standard sizes (cm)

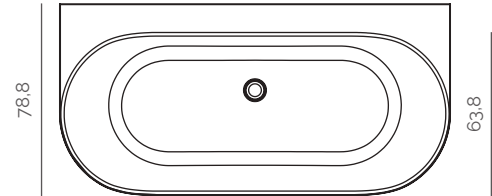
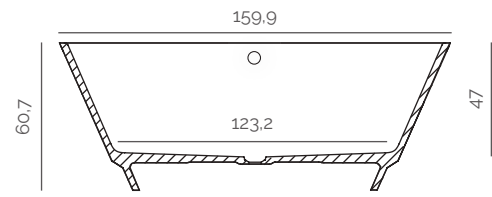

VOSSCOMPLEMENTS

Drain



Dolotek clic-clac drain

Finish

Chrome

Cover finish

Blanco mate



Trap (mm)

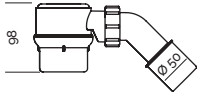

Standard trap H98



Installation materials



Joint sealant

Mapesil AC



Price

£ 19

VOSSTECHNICAL INFORMATION



Kg

Weight of the bathtub (Kg)

129,45



L

Water volume to overflow (L)

246

Product data sheet



Installation manual







Chrea bathtub · Hera Zero wallpanels NCS S 1020-B90G 100x90 cm · Basic Slate wallpanels NCS S 1020-B90G 100x70 cm

Price list

Chrea

Price

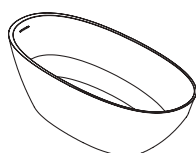

£ 3025

Colours

Standard

blanco mate



Standard sizes (cm)

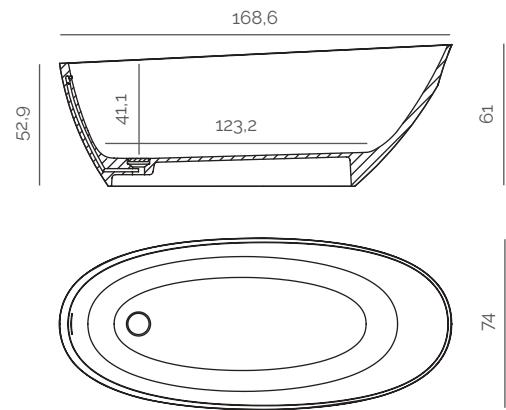





CHREACOMPLEMENTS

Drain



Dolotek clic-clac drain

Finish

Chrome

Cover finish

Blanco mate



Trap (mm)

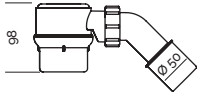

Standard trap H98



Installation materials



Joint sealant

Mapesil AC



Price

£ 19

CHREATECHNICAL INFORMATION



Kg

Weight of the bathtub (Kg)

121,40



L

Water volume to overflow (L)

226

Product data sheet



Installation manual







Levi bathtub

Price list

Levi

Price

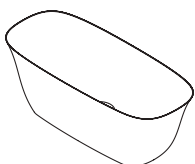

£2840



Colours

Standard

blanco mate





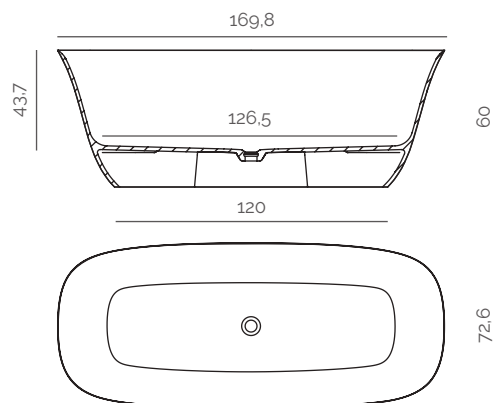

Standard sizes (cm)



LEVICOMPLEMENTS

Drain

		Finish	Cover finish		Price
	Clic-clac drain	Chrome	Blanco mate		-
	Clic-clac drain	Chrome	Chrome		£ 125

Trap (mm)



Standard trap Hg8



Installation materials

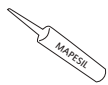

Joint sealant

Mapesil AC



Price

£ 19

LEVITECHNICAL INFORMATION



Kg

Weight of the bathtub (Kg) 121,72



L

Water volume (L) 350

Product data sheet



Installation manual







Vars bathtub · Hera Slate wallpanels NCS S 0530-Y80R 100x90 cm · Basic Slate wallpanels NCS S 0530-Y80R 100x70 cm

Price list

Vars	Price
	£ 3005

Colours

Standard

blanco mate



Standard sizes (cm)

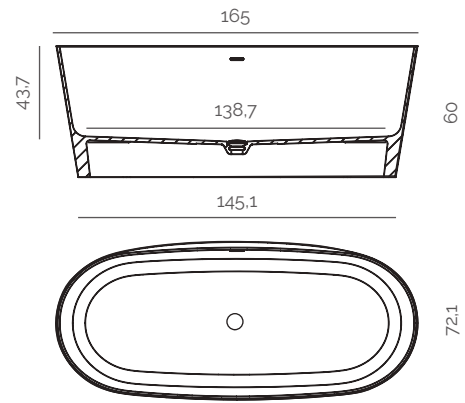

VARSCOMPLEMENTS

Drain



Dolotek clic-clac drain

Finish

Chrome

Cover finish

Blanco mate



Trap (mm)

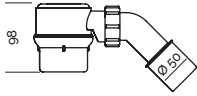

Standard trap H98



Installation materials



Joint sealant

Mapesil AC



Price

£ 19

VARSTECHNICAL INFORMATION



Kg

Weight of the bathtub (Kg)

110,60



L

Water volume to overflow (L)

300

Product data sheet



Installation manual







Venet bathtub

Price list

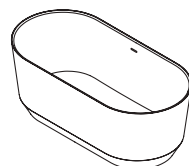
Venet	Price
	£3245



Colours

Standard

blanco mate



Standard sizes (cm)

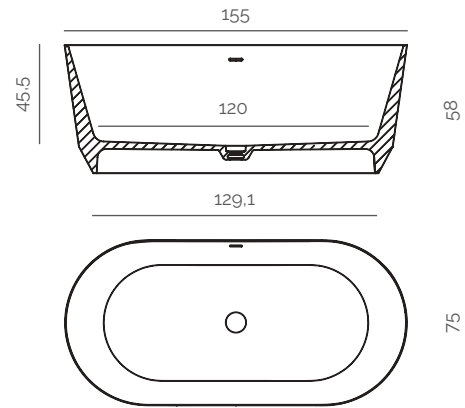

VENETCOMPLEMENTS

Drain



Dolotek clic-clac drain

Finish

Chrome

Cover finish

Blanco mate



Trap (mm)

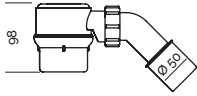

Standard trap H98



Installation materials



Joint sealant

Mapesil AC



Price

£ 19

VENETTECHNICAL INFORMATION



Weight of the bathtub (Kg)

192,84



Water volume to overflow (L)

298

Product data sheet



Installation manual





Boreal



Boreal bathtub

Price list

Boreal

Price

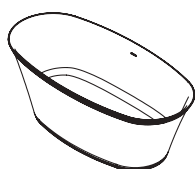

£3100



Colours

Standard

blanco mate



Standard sizes (cm)

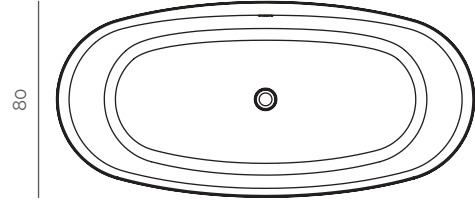
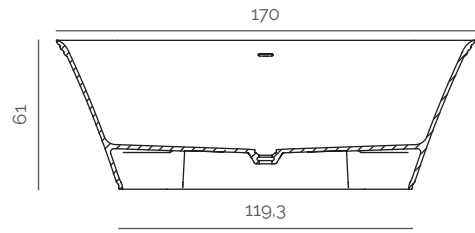

BOREALCOMPLEMENTS

Drain



Dolotek clic-clac drain

Finish

Chrome

Cover finish

Blanco mate



Trap (mm)

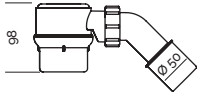

Standard trap H98



Installation materials

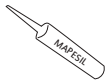

Joint sealant

Mapesil AC



Price

£ 19

BOREALTECHNICAL INFORMATION



Kg

Weight of the bathtub (Kg)

110,50



L

Water volume to overflow (L)

290

Product data sheet



Installation manual









Wallpanels

Basic 190-193

Quiz 194-197

Hera 198-201

Muretto Vintage 202-205

Muretto Loft 206-209

Basic



Price list

Basic Beton wallpanel crema 250x120 cm

70					90				
L (cm)	Standard	Nat. Made	Season	Ra/NCS	L (cm)	Standard	Nat. Made	Season	Ra/NCS
200	£ 278	£ 306	£ 306	£ 334	200	£ 417	£ 459	£ 459	£ 501
220	£ 306	£ 336	£ 336	£ 367	220	£ 459	£ 505	£ 505	£ 551
250	£ 348	£ 382	£ 382	£ 417	250	£ 522	£ 574	£ 574	£ 626

80					100				
L (cm)	Standard	Nat. Made	Season	Ra/NCS	L (cm)	Standard	Nat. Made	Season	Ra/NCS
200	£ 371	£ 408	£ 408	£ 445	200	£ 464	£ 510	£ 510	£ 556
220	£ 408	£ 449	£ 449	£ 489	220	£ 510	£ 561	£ 561	£ 612
250	£ 464	£ 510	£ 510	£ 556	250	£ 580	£ 638	£ 638	£ 696

Textures

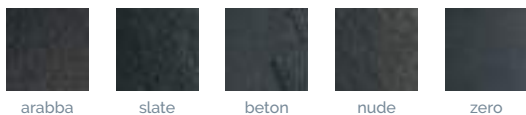

Colours

Standard

blanco nacar beige marfil crema

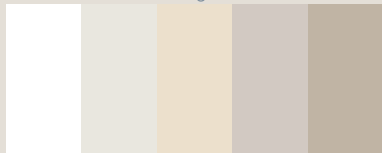

grey cemento moka lava negro



Naturally Made

sand capuccino fango platinum acier ink



Season

burgundy petal ocean sky forest mint

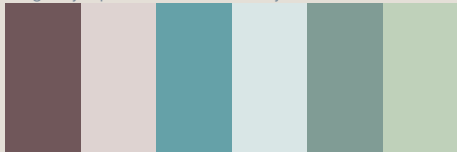

RaI/NCS



Standard sizes (cm)

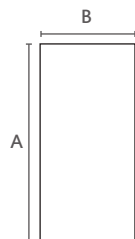







A	B
200	70/80/90/100/120
220	70/80/90/100/120
250	70/80/90/100/120

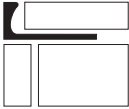

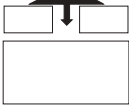

120	L (cm)	Standard	Nat. Made	Season	RaI/NCS
	200	£ 556	£ 612	£ 612	£ 668
	220	£ 612	£ 673	£ 673	£ 734
	250	£ 696	£ 765	£ 765	£ 835

BASICCOMPLEMENTS

Profiles

		Finish		Price
	Final profile	Chrome		£ 49
	Corner profile	Chrome		£ 49
	Profile between panels	Chrome		£ 49

Installation materials

				Price
	Adhesive glue	Ultrabond MS Rapid		£ 27
	Joint sealant	Mapesil AC		£ 19

Product data sheet



Installation manual





Quiz



Quiz wallpanels blanco 250x120 cm · One CF Beton worktop crema 240x50 cm · On-Top Colors Circle XL basins Beton NCS S 3050-Y80R · Moon mirrors Beton NCS S 3050-Y80R · Show go Quiz furniture NCS S 3050-Y80R · Show Quiz closet NCS S 3050-Y80R

Price list

	L (cm)	Standard	Nat. Made	Season	Ra/NCS
	250	£ 901	£ 983	£ 983	£ 1065

Texture



quiz

Colours

Standard



Naturally Made

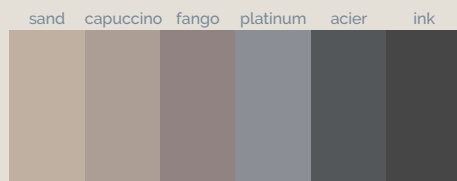

Season

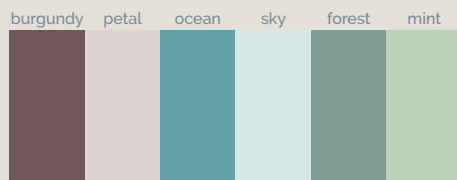

RaI/NCS





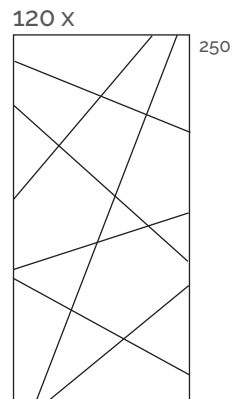



Standard sizes (cm)

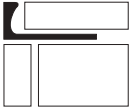



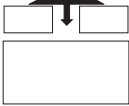

QUIZCOMPLEMENTS

Profiles

		Finish		Price
	Final profile	Chrome		£ 49
	Corner profile	Chrome		£ 49
	Profile between panels	Chrome		£ 49

Installation materials

				Price
	Adhesive glue	Ultrabond MS Rapid		£ 27
	Joint sealant	Mapesil AC		£ 19

QUIZTECHNICAL INFORMATION

Installation

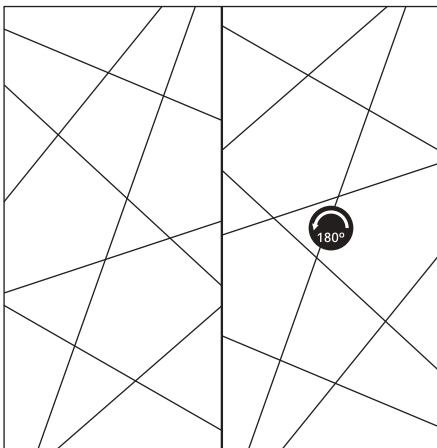

Product data sheet



Installation manual





Hera



Hera Zero wallpanels capuccino 250x100 cm

Price list

	L (cm)	Standard	Nat. Made	Season	RaI/NCS
	250	£ 901	£ 983	£ 983	£ 1065

Texture



zero



Colours

Standard



Naturally Made

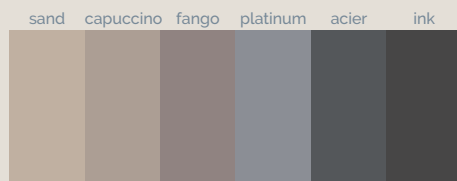

Season

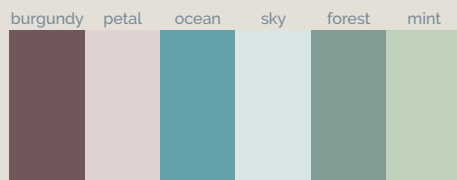

RaI/NCS





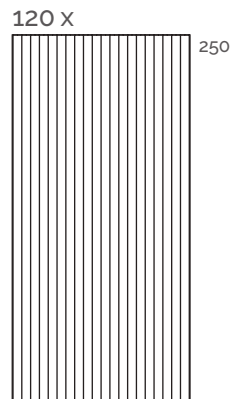

Standard sizes (cm)



HERACOMPLEMENTS

Installation materials

				Price
	Adhesive glue	Ultrabond MS Rapid		£ 27
	Joint sealant	Mapesil AC		£ 19

HERATECHNICAL INFORMATION

Installation

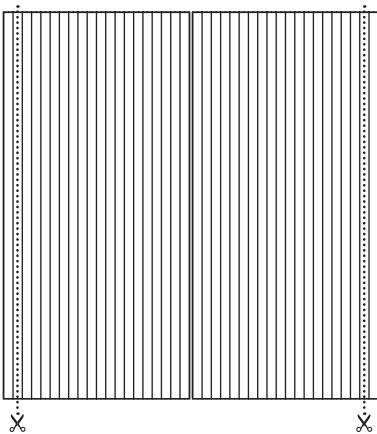

Product data
sheet



Installation
manual





Muretto Vintage



Muretto Vintage NCS S 3020-G30Y 120x45 cm

Price list

120	L (cm)	Standard	Nat. Made	Season	RaI/NCS
	45	£ 203	£ 216	£ 216	£ 229
	240	£ 896	£ 976	£ 976	£ 1058



Colours

Standard



Naturally Made

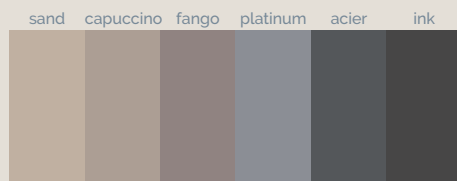

Season

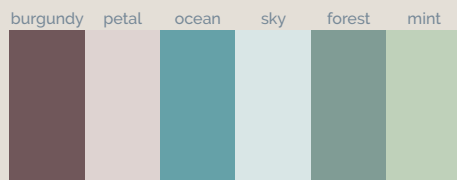

RaI/NCS





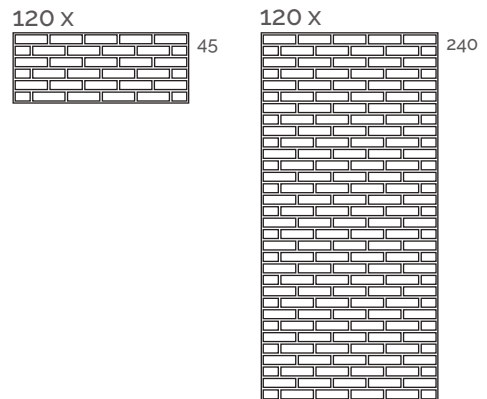

Standard sizes (cm)



MURETTO VINTAGE COMPLEMENTS

Installation materials

				Price
	Adhesive glue	Ultrabond MS Rapid		£ 27
	Joint sealant	Mapesil AC		£ 19

MURETTO VINTAGE TECHNICAL INFORMATION

Installation

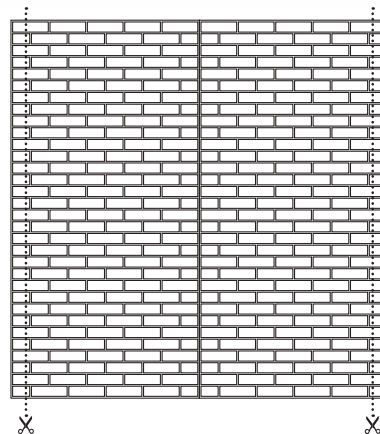
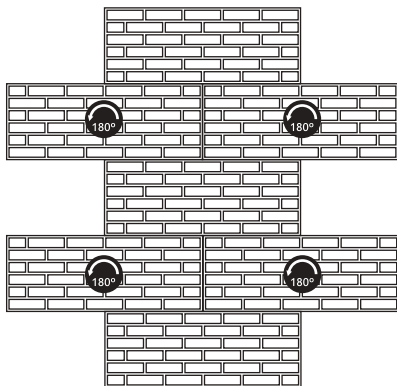

Product data sheet



Installation manual





Muretto Loft



Muretto Loft XL NCS S 4030-Y80R 250x120 cm

Price list

120	L (cm)	Standard	Nat. Made	Season	RaL/NCS
	250	£ 896	£ 976	£ 976	£ 1058

Texture



beton

Colours

Standard

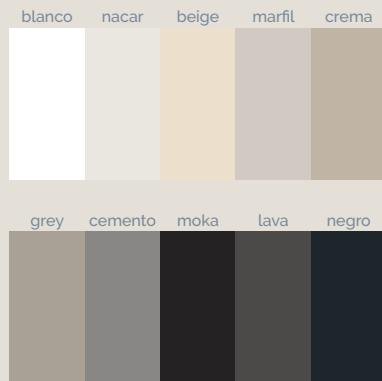

Naturally Made

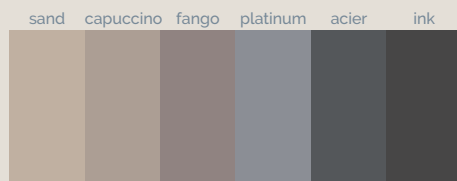

Season

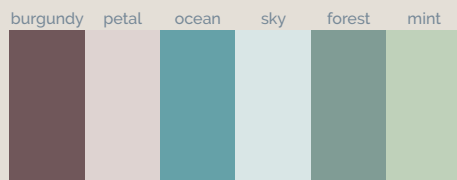

RaI/NCS





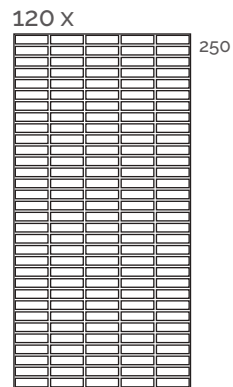

Standard sizes (cm)



MURETTO LOFTCOMPLEMENTS

Installation materials

				Price
	Adhesive glue	Ultrabond MS Rapid		£ 27
	Joint sealant	Mapesil AC		£ 19

MURETTO LOFTTECHNICAL INFORMATION

Installation

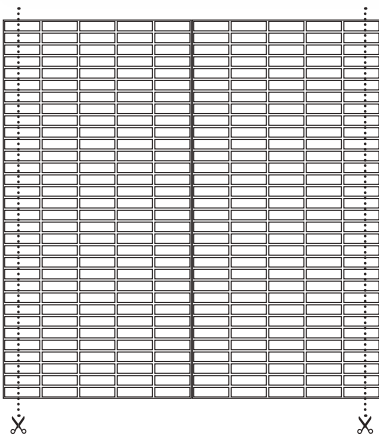

Product data
sheet



Installation
manual









Worktops

Integra 212-217

Integra 2 218-221

Mini 222-225

Infinity 226-229

Infinity 2 230-235

One 236-239

Moiwa 240-243

Integra



Integra CF 120 DX Slate worktop NCS S 3030-Y80R

Price list

Integra SF	Sizes (cm)	Standard	Nat. Made	Season	RaL/NCS
Integra 60 SF	60,3 x 46,5 x 1,3	£ 327	£ 355	£ 355	£ 376
Integra 80 SF	80,3 x 46,5 x 1,3	£ 355	£ 382	£ 382	£ 409
Integra 90 SF	90,3 x 46,5 x 1,3	£ 365	£ 398	£ 398	£ 426
Integra 100 SF	100,3 x 46,5 x 1,3	£ 376	£ 409	£ 409	£ 436
Integra 100 Sx SF	100,3 x 46,5 x 1,3	£ 376	£ 409	£ 409	£ 436
Integra 100 Dx SF	100,3 x 46,5 x 1,3	£ 376	£ 409	£ 409	£ 436
Integra 120 SF	120,3 x 46,5 x 1,3	£ 436	£ 474	£ 474	£ 507
Integra 120 Sx SF	120,3 x 46,5 x 1,3	£ 436	£ 474	£ 474	£ 507
Integra 120 Dx SF	120,3 x 46,5 x 1,3	£ 436	£ 474	£ 474	£ 507
Integra 120 XL SF	120,3 x 46,5 x 1,3	£ 524	£ 568	£ 568	£ 616

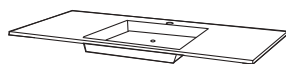



slate

Colours

Standard

blanco nacar beige marfil crema

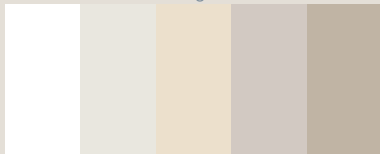

grey cemento moka lava negro

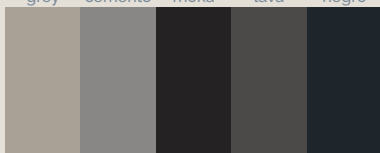

Naturally Made

sand capuccino fango platinum acier ink



Season

burgundy petal ocean sky forest mint

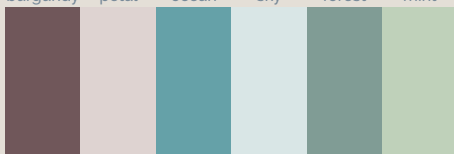

RaI/NCS



Standard sizes (cm)

Integra 60

SF: 60,3 / CF: 60

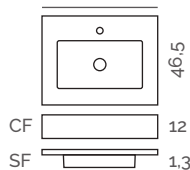

Integra 80

SF: 80,3 / CF: 80

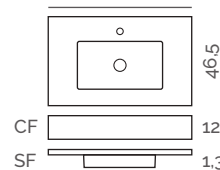

Integra 90

SF: 90,3 / CF: 90

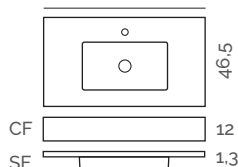

Integra 100

SF: 100,3 / CF: 100

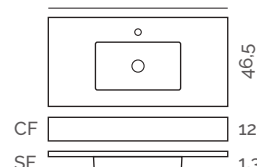

Integra 100 Sx

SF: 100,3 / CF: 100

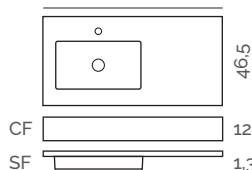

Integra 100 Dx

SF: 100,3 / CF: 100

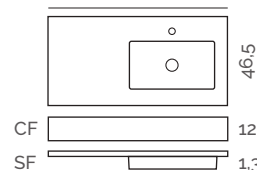

Integra 120

SF: 120,3 / CF: 120

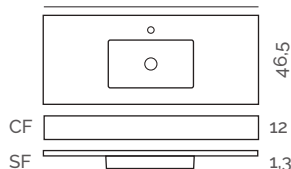

Integra 120 Sx

SF: 120,3 / CF: 120

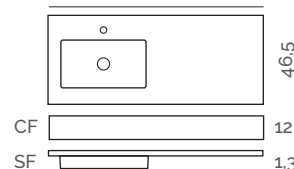

Integra 120 Dx

SF: 120,3 / CF: 120

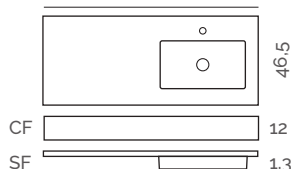

Integra 120 XL

SF: 120,3 / CF: 120

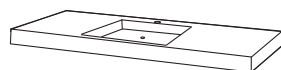
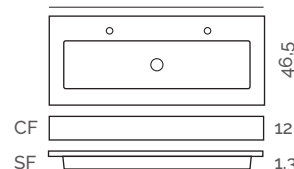

Integra CF

	Sizes (cm)	Standard	Nat. Made	Season	RaI/NCS
Integra 60 CF	60 x 46,5 x 12	£ 448	£ 485	£ 485	£ 524
Integra 80 CF	80 x 46,5 x 12	£ 524	£ 568	£ 568	£ 616
Integra 90 CF	90 x 46,5 x 12	£ 552	£ 600	£ 600	£ 649
Integra 100 CF	100 x 46,5 x 12	£ 585	£ 639	£ 639	£ 688
Integra 100 Sx CF	100 x 46,5 x 12	£ 585	£ 639	£ 639	£ 688
Integra 100 Dx CF	100 x 46,5 x 12	£ 585	£ 639	£ 639	£ 688
Integra 120 CF	120 x 46,5 x 12	£ 682	£ 742	£ 742	£ 803
Integra 120 Sx CF	120 x 46,5 x 12	£ 682	£ 742	£ 742	£ 803
Integra 120 Dx CF	120 x 46,5 x 12	£ 682	£ 742	£ 742	£ 803
Integra 120 XL CF	120 x 46,5 x 12	£ 775	£ 813	£ 813	£ 917



Integra SF: tap hole included, centred with respect to the basin.
Integra CF: tap hole included, centred with respect to the basin. Possibility, on request, of not including it.









INTEGRACOMPLEMENTS



Basins

	Sizes (cm)	Integra 60	Integra 80	Integra 90	Integra 100	Integra 120	Integra 120 XL
	26,7 x 50 x 9	✓	✓	✓	✓	✓	
	26,7 x 104 x 9						✓



Drains

		Finish		Standard	Nat. Made	Season	RaL/NCS
	Akron clic-clac drain	Chrome / Black		£ 59	£ 65	£ 65	£ 70
	Akron free drain	Chrome / Black		£ 59	£ 65	£ 65	£ 70

Upstand

		Texture	Sizes (cm)		Standard	Nat. Made	Season	RaL/NCS
	Upstand	Slate	60 - 120 x 3 x 1,6		£ 0,45 cm linear	£ 0,50 cm linear	£ 0,50 cm linear	£ 0,56 cm linear

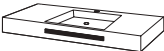



Towel rail

		Sizes (cm)	Integra CF	Price
	Front towel rail Show	40 x 4		£ 163

Fixing system

		Integra CF	Integra SF
	Fixing system	✓	

Installation materials

			Price
	Adhesive glue	Ultrabond MS Rapid	 £ 27
	Joint sealant	Mapesil AC	 £ 19

Product data sheet



Installation manual





Integra 2



Integra 2 CF 140 Slate worktop capuccino · Basic Slate wallpanels blanco 250x100 cm · Urban mirror

Price list

Integra-2 SF		Sizes (cm)	Standard	Nat. Made	Season	RaL/NCS
	Integra-2 120 SF	120,3 x 46,5 x 1,3	£524	£568	£568	£616
	Integra-2 140 SF	140,3 x 46,5 x 1,3	£585	£639	£639	£688
Integra-2 CF		Sizes (cm)	Standard	Nat. Made	Season	RaL/NCS
	Integra-2 120 CF	120 x 46,5 x 12	£775	£813	£813	£917
	Integra-2 140 CF	140 x 46,5 x 12	£874	£934	£934	£1033

Texture



slate

Colours

Standard

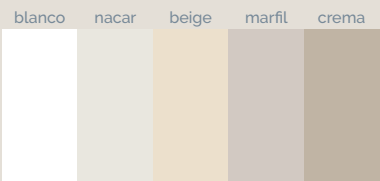

Naturally Made

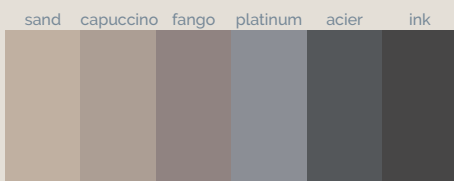

Season

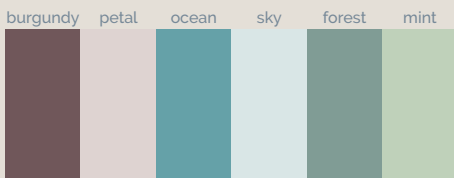

RaI/NCS



Standard sizes (cm)

Integra-2 120

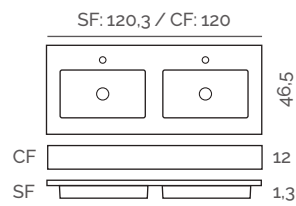

Integra-2 140

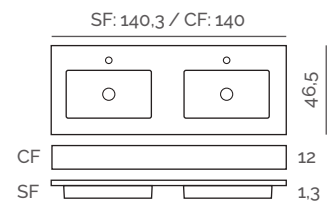





INTEGRA 2COMPLEMENTS



Basin

		Sizes (cm)	Integra-2 120	Integra-2 140
		26,7 x 50 x 9		



Drains

		Finish		Standard	Nat. Made	Season	Ra/NCS
	Akron clic-clac drain	Chrome / Black		£ 59	£ 65	£ 65	£ 70
	Akron free drain	Chrome / Black		£ 59	£ 65	£ 65	£ 70

Upstand

		Texture	Sizes (cm)		Standard	Nat. Made	Season	Ra/NCS
	Upstand	Slate	120 - 140 x 3 x 1,6		£ 0,45 cm linear	£ 0,50 cm linear	£ 0,50 cm linear	£ 0,56 cm linear

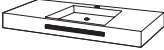



Towel rail

		Sizes (cm)	Integra-2 CF	Price
	Front towel rail Show	40 x 4		£ 163

Fixing system

		Integra-2 CF	Integra-2 SF
	Fixing system		

Installation materials

		Price
	Adhesive glue	Ultrabond MS Rapid  £ 27
	Joint sealant	Mapesil AC  £ 19

Product data sheet



Installation manual





Mini



Mini Slate worktops blanco · Basic Slate wallpanel NCS S 4020-R90B 250x120 cm · Urban mirror

Price list

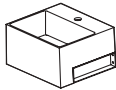
	Sizes (cm)	Standard	Nat. Made	Season	RaL/NCS
	40 x 35 x 21	£562	£611	£611	£661

Texture



slate

Colours

Standard

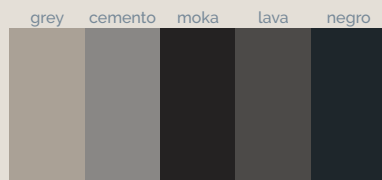
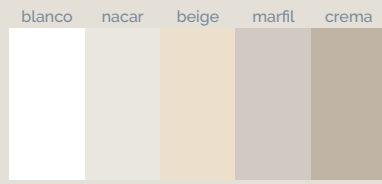

Naturally Made

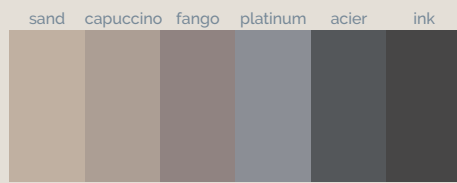

Season

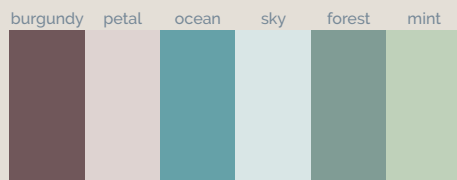

RaI/NCS



Standard sizes (cm)

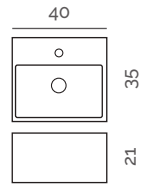

MINICOMPLEMENTS



Basin

	Sizes (cm) 23,4 x 38 x 12,1	
---	--------------------------------	---



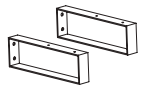

Drains

		Finish		Standard	Nat. Made	Season	RaI/NCS
	Akron clic-clac drain	Chrome / Black		£ 59	£ 65	£ 65	£ 70
	Akron free drain	Chrome / Black		£ 59	£ 65	£ 65	£ 70

Fixing system

	Fixing system	Finish Shiny stainless / Black	
---	---------------	-----------------------------------	---

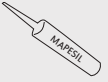
Installation materials

				Price
	Adhesive glue	Ultrabond MS Rapid		£ 27
	Joint sealant	Mapesil AC		£ 19

Product data sheet



Installation manual





Infinity



Infinity 52 CF Arabba worktop capuccino 200x50 cm

Price list

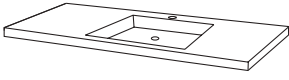
 <p>Infinity CF</p>	<p>Sizes (cm)</p> <p>60 - 240 x 46 - 55 x 12</p>	<p>Standard</p> <p>£ 8,20 cm linear</p>	<p>Nat. Made</p> <p>£ 8,96 cm linear</p>	<p>Season</p> <p>£ 8,96 cm linear</p>	<p>RaI/NCS</p> <p>£ 9,61 cm linear</p>
 <p>Infinity CFR</p>	<p>Sizes (cm)</p> <p>60 - 240 x 46 - 55 x 4</p>	<p>Standard</p> <p>£ 7,87 cm linear</p>	<p>Nat. Made</p> <p>£ 8,52 cm linear</p>	<p>Season</p> <p>£ 8,52 cm linear</p>	<p>RaI/NCS</p> <p>£ 9,18 cm linear</p>
 <p>Infinity SF</p>	<p>Sizes (cm)</p> <p>60 - 240 x 46 - 55 x 1,6</p>	<p>Standard</p> <p>£ 5,30 cm linear</p>	<p>Nat. Made</p> <p>£ 5,74 cm linear</p>	<p>Season</p> <p>£ 5,74 cm linear</p>	<p>RaI/NCS</p> <p>£ 6,17 cm linear</p>

Textures

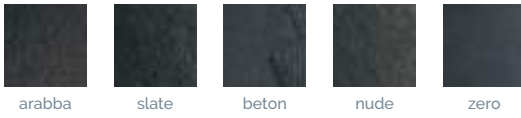

Colours

Standard

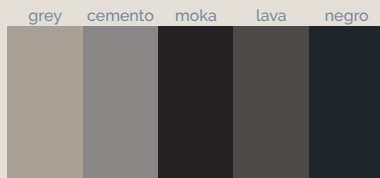
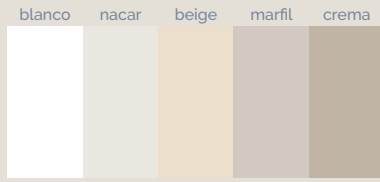

Naturally Made

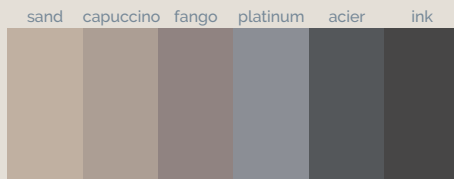

Season

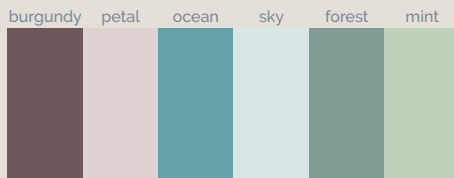

RaI/NCS



Standard sizes (cm)

Infinity 42

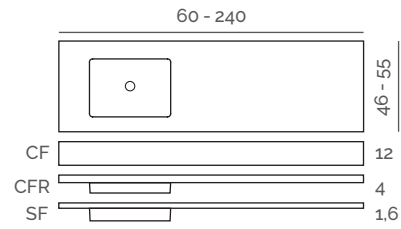

Infinity 52

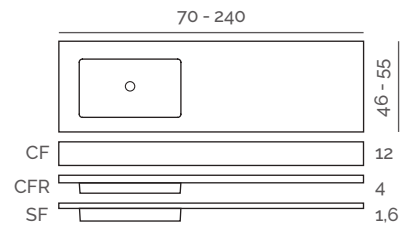

Infinity Round 52

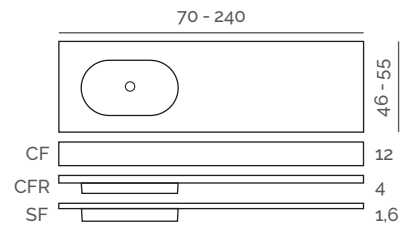

Infinity 62

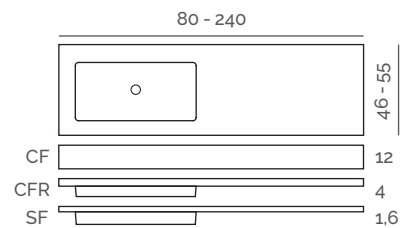





NOTE: it is necessary to add the worktop design with all the measurements in each order.

Order form







INFINITYCOMPLEMENTS



Basins

		Sizes (cm)	Worktop size	Infinity 42	Infinity 52	Infinity 62
	Basin 42	30 x 42 x 10	Infinity 60 - 240	✓		
	Basin 52	30 x 52 x 10	Infinity 70 - 240		✓	
	Basin 52 Round	30 x 52 x 10	Infinity 70 - 240		✓	
	Basin 62	30 x 62 x 10	Infinity 80 - 240			✓

Drains

		Finish		Standard	Nat. Made	Season	Ra/NCS
	Akron clic-clac drain	Chrome / Black		£ 59	£ 65	£ 65	£ 70
	Akron free drain	Chrome / Black		£ 59	£ 65	£ 65	£ 70

Upstand

		Texture	Sizes (cm)		Standard	Nat. Made	Season	Ra/NCS
	Upstand	Arabba / Slate / Beton / Nude / Zero	60 - 240 x 3 x 1,6		£ 0,45 cm linear	£ 0,50 cm linear	£ 0,50 cm linear	£ 0,56 cm linear

Towel rails

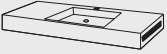
		Sizes (cm)	Infinity CF	Price
	Front towel rail Show	40 x 4		£ 163
	Right towel rail Show	40 x 4		£ 163
	Left towel rail Show	40 x 4		£ 163

Fixing system

		Infinity CF	Infinity CFR	Infinity SF
	Fixing system	✓	✓	





Product data sheet



Installation manual



Installation materials

				Price
	Adhesive glue	Ultrabond MS Rapid		£ 27
	Joint sealant	Mapesil AC		£ 19



Infinity 2



Infinity 2 Round 52 CF Beton worktop platinum 220x46 cm

Price list

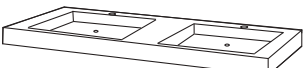
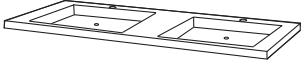
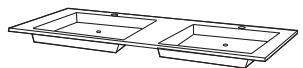
	Sizes (cm)	Standard	Nat. Made	Season	RaI/NCS
 Infinity-2 CF	120 - 240 x 46 - 55 x 12	£ 9,40 cm linear	£ 10,27 cm linear	£ 10,27 cm linear	£ 11,08 cm linear
 Infinity-2 CFR	140 - 240 x 46 - 55 x 4	£ 9,26 cm linear	£ 10,11 cm linear	£ 10,11 cm linear	£ 10,93 cm linear
 Infinity-2 SF	160 - 240 x 46 - 55 x 1,6	£ 6,95 cm linear	£ 7,62 cm linear	£ 7,62 cm linear	£ 8,17 cm linear

Textures

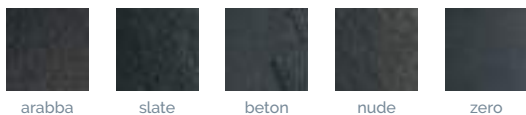

Colours

Standard

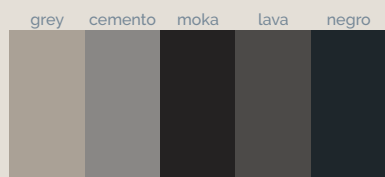
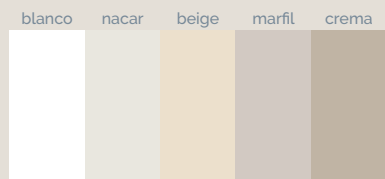

Naturally Made

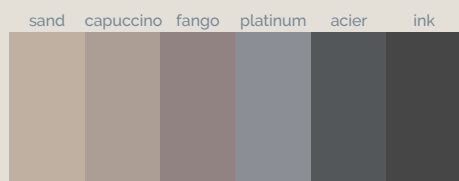

Season

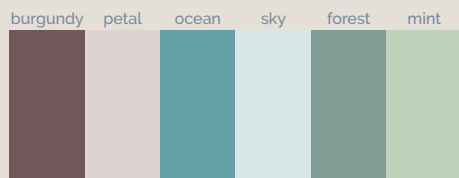

RaI/NCS



Standard sizes (cm)

Infinity-2 42

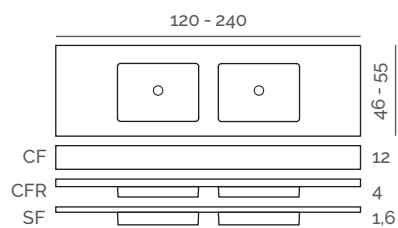

Infinity-2 52

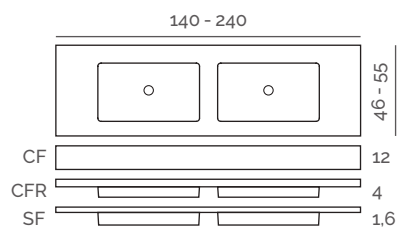

Infinity-2 Round 52

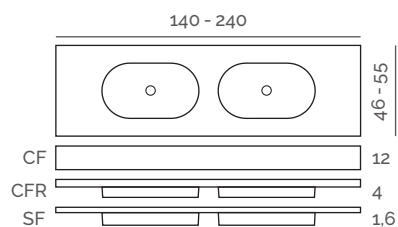

Infinity-2 62

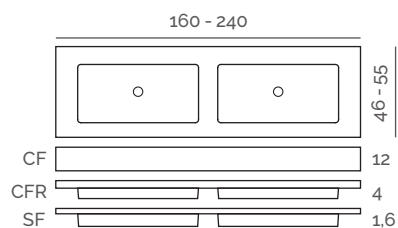

NOTE: it is necessary to add the worktop design with all the measurements in each order.

Order form















INFINITY 2 COMPLEMENTS



Basins

		Sizes (cm)	Worktop size	Infinity-2 42	Infinity-2 52	Infinity-2 62
	Basin 42	30 x 42 x 10	Infinity-2 120 - 240	✓		
	Basin 52	30 x 52 x 10	Infinity-2 140 - 240		✓	
	Basin 52 Round	30 x 52 x 10	Infinity-2 140 - 240		✓	
	Basin 62	30 x 62 x 10	Infinity-2 160 - 240			✓

Drains

		Finish		Standard	Nat. Made	Season	Ra/NCS
	Akron clic-clac drain	Chrome / Black		£ 59	£ 65	£ 65	£ 70
	Akron free drain	Chrome / Black		£ 59	£ 65	£ 65	£ 70

Upstand

		Texture	Sizes (cm)		Standard	Nat. Made	Season	Ra/NCS
	Upstand	Arabba / Slate / Beton / Nude / Zero	120 - 240 x 3 x 1,6		£ 0,45 cm linear	£ 0,50 cm linear	£ 0,50 cm linear	£ 0,56 cm linear

Towel rails

		Sizes (cm)	Infinity-2 CF	Price
	Front towel rail Show	40 x 4		£ 163
	Right towel rail Show	40 x 4		£ 163
	Left towel rail Show	40 x 4		£ 163

Fixing system

		Infinity-2 CF	Infinity-2 CFR	Infinity-2 SF
	Fixing system	✓	✓	





Product data sheet



Installation manual



Installation materials

				Price
	Adhesive glue	Ultrabond MS Rapid		£ 27
	Joint sealant	Mapesil AC		£ 19





One CF Beton worktop sky 180x50 cm

Price list

	Sizes (cm)	Standard	Nat. Made	Season	RaL/NCS
One CF 	60 - 240 x 46 - 55 x 12	£ 6,78 cm linear	£ 7,33 cm linear	£ 7,33 cm linear	£ 7,92 cm linear
One CFR 	60 - 240 x 46 - 55 x 4	£ 5,79 cm linear	£ 6,26 cm linear	£ 6,26 cm linear	£ 6,78 cm linear
One SF 	60 - 240 x 46 - 55 x 1,6	£ 4,81 cm linear	£ 5,20 cm linear	£ 5,20 cm linear	£ 5,59 cm linear

Textures

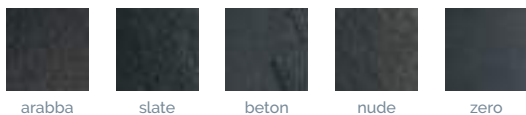

Colours

Standard

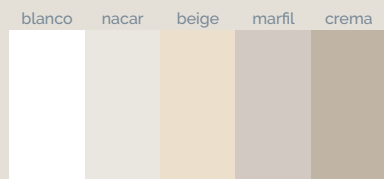

Naturally Made

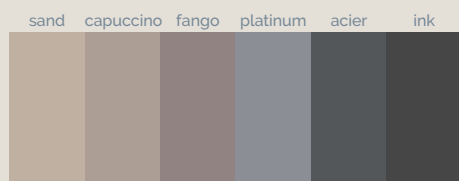

Season

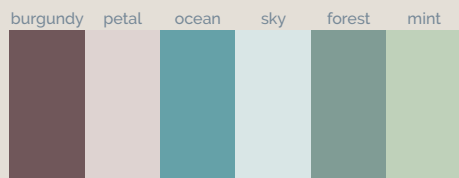

RaI/NCS



Standard sizes (cm)

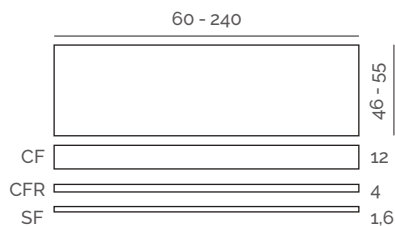



NOTE: it is necessary to add the worktop design with all the measurements in each order.

Order form





ONECOMPLEMENTS

Upstand

	Texture	Sizes (cm)		Standard	Nat. Made	Season	RaI/NCS
 Upstand	Arabba / Slate / Betón / Nude / Zero	60 - 120 x 3 x 1,6		£ 0,45 cm linear	£ 0,50 cm linear	£ 0,50 cm linear	£ 0,56 cm linear





Towel rails

		Sizes (cm)		One CF	Price
 Front towel rail Show		40 x 4			£ 163
 Right towel rail Show		40 x 4			£ 163
 Left towel rail Show		40 x 4			£ 163

Fixing system

		One CF	One CFR	One SF
 Fixing system				

Installation materials

				Price
 Ahesive glue		Ultrabond MS Rapid		£ 27
 Joint sealant		Mapesil AC		£ 19

Product data
sheet



Installation
manual







Moiwa 121 worktop

Price list

Moiwa 81	Sizes (cm)	Price	Moiwa 91	Sizes (cm)	Price
	81 x 46 x 12	£ 720		91 x 46 x 12	£ 731

Colours

Standard

blanco mate



Standard sizes (cm)

Moiwa 81

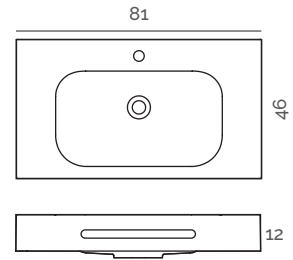

Moiwa 91

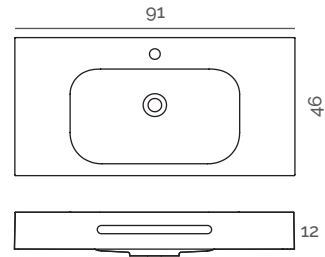

Moiwa 101

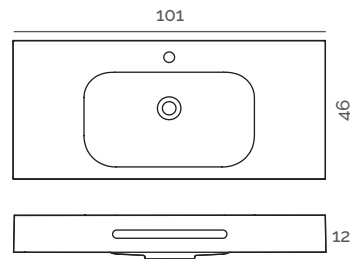



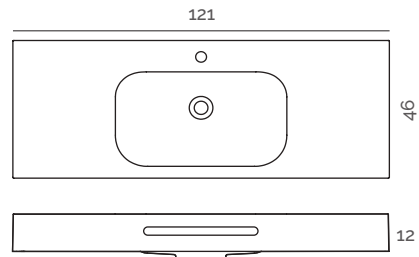

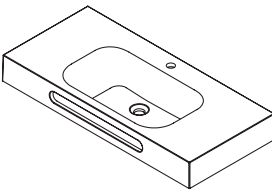
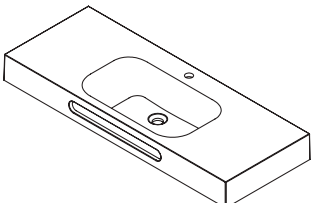



Moiwa 121





Moiwa 101	Sizes (cm)	Price	Moiwa 121	Sizes (cm)	Price
	101 x 46 x 12	£ 848		121 x 46 x 12	£ 869

MOIWA COMPLEMENTS

Drains

		Finish	Cover finish		Price
	Clic-clac drain	Chrome	Chrome		£ 61
	Free outlet drain	Chrome	Chrome		£ 61
	Pop Down drain	Chrome	Chrome		£ 76
	Flat drain	Chrome	Chrome		£ 61

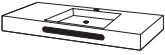
Towel rail

		Sizes (cm)	
	Moiwa towel rail	50 x 5	

Fixing system

	Fixing system		
---	---------------	--	---

Installation materials

				Price
	Joint sealant	Mapesil AC		£ 19

Product data sheet



Installation manual









Basins

Delia 246-249

On-Top 250-255

Chrea 256-259

Levi 260-263

Vars 264-267

Venet 268-271



Delia Zero basin forest

Price list

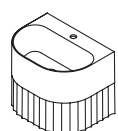

Sizes (cm)	Standard	Nat. Made	Season	RaL/NCS
50,4 x 37,5 x 40	£531	£584	£584	£637

Texture



zero

Colours

Standard

blanco nacar beige marfil crema

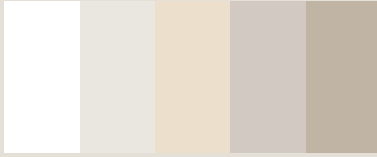

grey cemento moka lava negro



Naturally Made

sand capuccino fango platinum acier ink

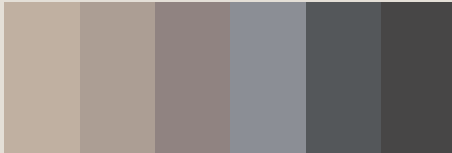

Season

burgundy petal ocean sky forest mint

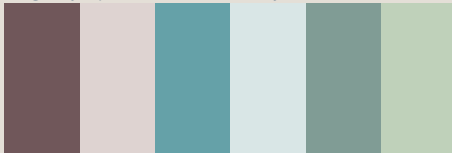

RaI/NCS



Standard sizes (cm)

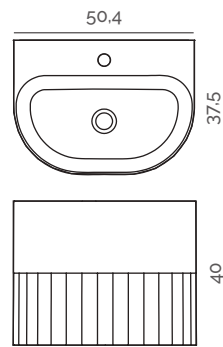

Award







archiproducts
DESIGN AWARDS
2022

WINNER

DELIACOMPLEMENTS

Drains

		Finish		Standard	Nat. Made	Season	RaI/NCS
	Akron clic-clac drain	Chrome / Black		£ 59	£ 65	£ 65	£ 70
	Akron free drain	Chrome / Black		£ 59	£ 65	£ 65	£ 70

Fixing system

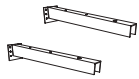

Fixing system



Installation materials



Joint sealant

Mapesil AC



Price

£ 19

Product data sheet



Installation manual







On-top Rectangle XL Beton basins NCS S 3040-Y60R

Price list

On-Top Circle	Sizes (cm)	Standard	Nat. Made	Season	RaI/NCS	On-Top Colors Circle	Colors
	Ø 38 x 11	£ 360	£ 389	£ 389	£ 416		£ 450
On-Top Circle XL	Sizes (cm)	Standard	Nat. Made	Season	RaI/NCS	On-Top Colors Circle XL	Colors
	Ø 40 x 15	£ 471	£ 511	£ 511	£ 551		£ 594
On-Top Square	Sizes (cm)	Standard	Nat. Made	Season	RaI/NCS	On-Top Colors Square	Colors
	38 x 38 x 11	£ 416	£ 450	£ 450	£ 483		£ 517
On-Top Square XL	Sizes (cm)	Standard	Nat. Made	Season	RaI/NCS	On-Top Colors Square XL	Colors
	40 x 40 x 15	£ 499	£ 539	£ 539	£ 578		£ 621

Textures

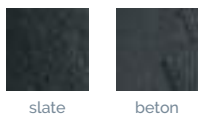

Colours

Standard



Naturally Made

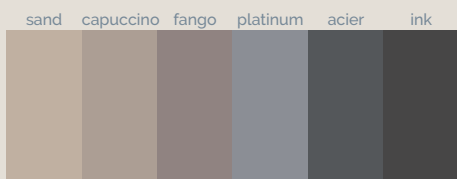

Season

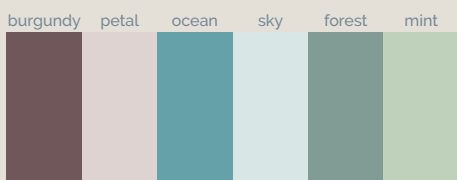

RaI/NCS



Standard sizes (cm)

On-Top Circle

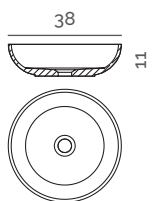

On-Top Circle XL

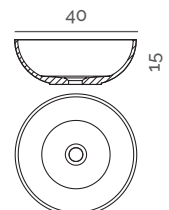

On-Top Square

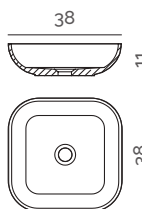

On-Top Square XL

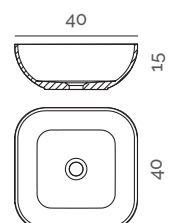

On-Top Oval

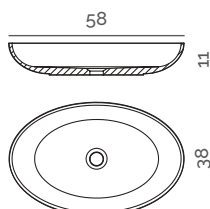

On-Top Oval XL

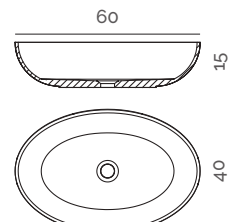

On-Top Rectangle

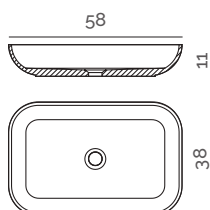

On-Top Rectangle XL

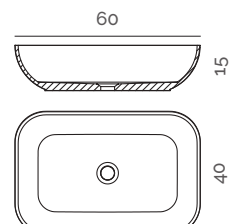

NOTE: 5 cm diameter drain.

Basins

On-Top Oval	Sizes (cm)	Standard	Nat. Made	Season	RaI/NCS	On-Top Colors Oval	Colors
	58 x 38 x 11	£ 405	£ 437	£ 437	£ 469		£ 505
On-Top Oval XL	Sizes (cm)	Standard	Nat. Made	Season	RaI/NCS	On-Top Colors Oval XL	Colors
	60 x 40 x 15	£ 487	£ 526	£ 526	£ 563		£ 606
On-Top Rectangle	Sizes (cm)	Standard	Nat. Made	Season	RaI/NCS	On-Top Colors Rectangle	Colors
	58 x 38 x 11	£ 471	£ 511	£ 511	£ 551		£ 594
On-Top Rectangle XL	Sizes (cm)	Standard	Nat. Made	Season	RaI/NCS	On-Top Colors Rectangle XL	Colors
	60 x 40 x 15	£ 566	£ 612	£ 612	£ 661		£ 712





NOTE: the maximum dimensions of Akron products can vary by ±0.5% in length and width.





ON-TOPCOMPLEMENTS

Drains

		Finish		Standard	Nat. Made	Season	RaI/NCS
	Akron clic-clac drain	Chrome / Black		£ 59	£ 65	£ 65	£ 70
	Akron free drain	Chrome / Black		£ 59	£ 65	£ 65	£ 70

Installation materials

				Price
	Joint sealant	Mapesil AC		£ 19

Product data sheet



Installation manual







Chrea basin

Price list



Sizes (cm)

Ø 40 x 22,9

Price

£ 583



Colours

Standard

blanco mate



Standard sizes (cm)

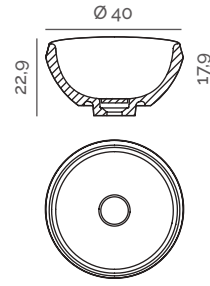

CHREACOMPLEMENTS

Drain



Dolotek clic-clac drain

Finish

Chrome

Cover finish

Blanco mate



Installation materials



Joint sealant

Mapesil AC



Price

£ 19

Product data
sheet



Installation
manual







Levi Rectangle basin

Price list

Levi Circle XL



Sizes (cm)

Ø 41,5 x 15,2

Price

£ 500

Levi Rectangle



Sizes (cm)

46 x 32 x 15,2

Price

£ 578

Colours

Standard

blanco mate



Standard sizes (cm)

Levi Circle XL

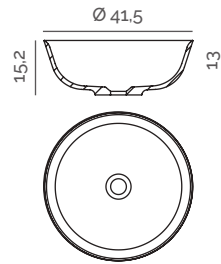

Levi Rectangle

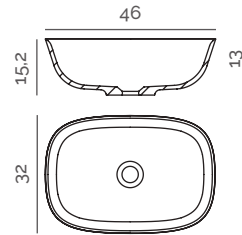

Levi Rectangle XL

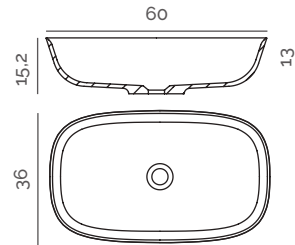

Levi Rectangle XL



Sizes (cm)









60 x 36 x 15,2

Price

£663

LEVICOMPLEMENTS

Drains

		Finish	Cover finish		Price
	Clic-clac drain	Chrome	Chrome		£ 61
	Free outlet drain	Chrome	Chrome		£ 61
	Pop Down drain	Chrome	Chrome		£ 76
	Flat drain	Chrome	Chrome		£ 61

Installation materials

				Price
	Joint sealant	Mapesil AC		£ 19

Product data sheet



Installation manual







Vars Rectangle XL basin

Price list

Vars Circle



Sizes (cm)

Ø 40 x 12,1

Price

£ 484

Vars Circle XL



Sizes (cm)

Ø 40 x 15,1

Price

£ 522

Colours

Standard

blanco mate



Standard sizes (cm)

Vars Circle

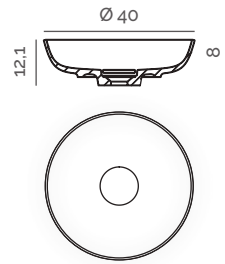

Vars Circle XL

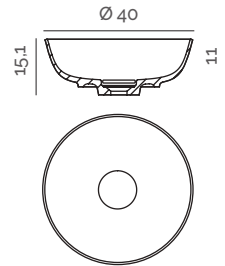

Vars Square XL

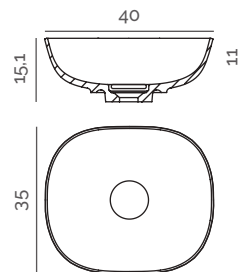

Vars Rectangle XL

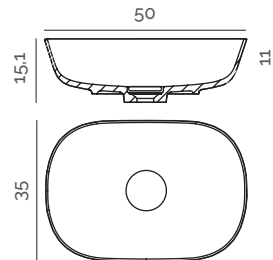

Vars Square XL



Sizes (cm)

40 x 35 x 15,1

Price

£ 602

Vars Rectangle XL



Sizes (cm)



50 x 35 x 15,1

Price





£ 685

VARSCOMPLEMENTS

Cover

		Material	Cover finish	
	Dolotek cover	Dolotek	Blanco mate	

Drains

		Finish	Cover finish		Price
	Pop Down drain	Chrome	Chrome		£ 76
	Flat drain	Chrome	Chrome		£ 61

Installation materials

				Price
	Joint selant	Mapesil AC		£ 19

Product data sheet



Installation manual







Venet Square basin

Price list

Venet Circle



Sizes (cm)

Ø 42 x 12,2

Price

£ 500

Venet Circle XL



Sizes (cm)

Ø 43,2 x 17,2

Price

£ 541

Colours

Standard

blanco mate



Standard sizes (cm)

Venet Circle

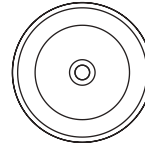
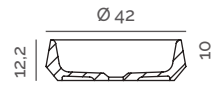

Venet Circle XL

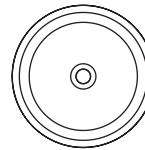

Venet Square

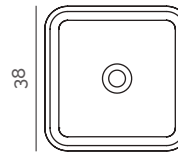
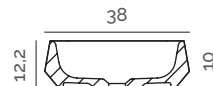

Venet Rectangle

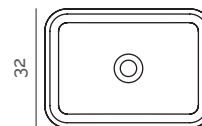
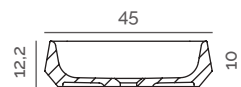

Venet Square



Sizes (cm)

38 x 38 x 12,2

Price

£578

Venet Rectangle



Sizes (cm)









45 x 32 x 12,2

Price



£663

VENETCOMPLEMENTS

Drains

		Finish	Cover finish		Price
	Clic-clac drain	Chrome	Chrome		£ 61
	Free outlet drain	Chrome	Chrome		£ 61
	Pop Down drain	Chrome	Chrome		£ 76
	Flat drain	Chrome	Chrome		£ 61

Installation materials

				Price
	Joint sealant	Mapesil AC		£ 19

Product data sheet



Installation manual









Totems

Icon 274-277

Levi 278-281

Vars 282-285



Totem Icon Slate blanco

Price list

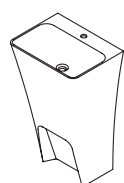

Sizes (cm)	Standard	Nat. Made	Season	RaI/NCS
52 x 40 x 85	£ 908	£ 999	£ 999	£ 1090

Texture



slate

Colours

Standard

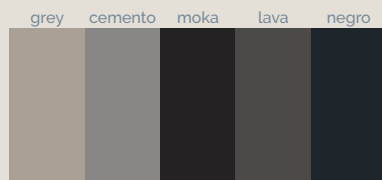
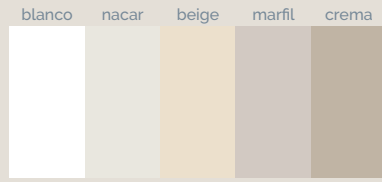

Naturally Made

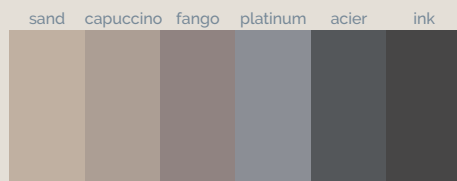

Season

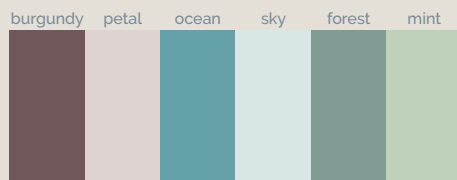

RaI/NCS





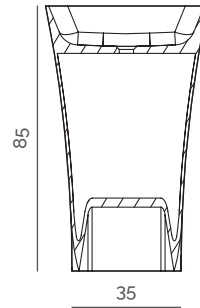
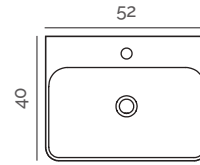

Standard sizes (cm)



ICONCOMPLEMENTS

Drains

		Finish		Standard	Nat. Made	Season	RaI/NCS
	Akron clic-clac drain	Chrome / Black		£ 59	£ 65	£ 65	£ 70
	Akron free drain	Chrome / Black		£ 59	£ 65	£ 65	£ 70

Fixing system



Fixing system



Installation materials

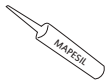

Joint sealant

Mapesil AC



Price

£ 19

Product data sheet



Installation manual







Totem Levi

Price list

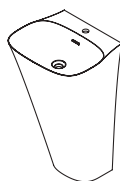
	Sizes (cm)	Price
	51,9 x 45 x 85	£ 1321



Colours

Standard

blanco mate



Standard sizes (cm)

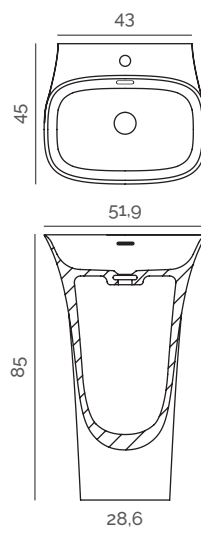

LEVICOMPLEMENTS

Drain



Clic-clac drain with overflow

Finish

Chrome

Cover finish

Chrome



Price

£ 76

Fixing system



Fixing system



Installation materials



Joint sealant

Mapesil AC



Price

£ 19

Product data sheet



Installation manual







Totem Vars

Price list

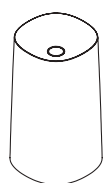

Sizes (cm)

50 x 45 x 85

Price

£ 1422



Colours

Standard

blanco mate



Standard sizes (cm)

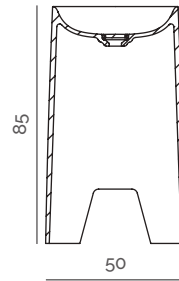
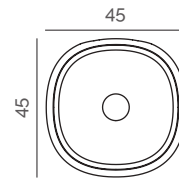

VARSCOMPLEMENTS

Cover



Dolotek cover

Material

Dolotek

Finish

Blanco mate



Drains



Pop Down drain

Finish

Chrome

Cover finish

Chrome



Price

£ 76



Flat drain

Chrome

Chrome



£ 61

Installation materials



Joint sealant

Mapesil AC



Price

£ 19

Product data sheet



Installation manual









Furniture and accessories

<i>Artic furniture</i>	288-291
<i>Delia furniture</i>	292-293
<i>Integra furniture</i>	294-295
<i>Integra floor standing furniture</i>	296-297
<i>Urban furniture</i>	298-299
<i>Show furniture</i>	300-301
<i>Show closet</i>	302-303
<i>Show stool</i>	304-305
<i>Show seat wall</i>	306-307
<i>Box shelf</i>	308-309
<i>Show shelf</i>	310-311
<i>Corner Show shelf</i>	312-313
<i>Cladding for toilet</i>	314-315
<i>Moon mirror</i>	316-317
<i>Urban mirror</i>	318-319
<i>Show mirror</i>	320-321
<i>Kendo shower column</i>	322-323

Artic furniture



Artic 80 blanco furniture · Artic 40 madera furniture · Infinity 2 SF Slate worktop capuccino 240x46,1 cm · Basic Slate wallpanel capuccino 240x20 cm

Price list

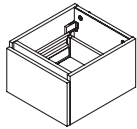
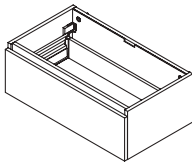
Artic 40	Sizes (cm)	Finish	Price	Artic 80	Sizes (cm)	Finish	Price
	40 x 45,6 x 28	Blanco	£ 564		80 x 45,6 x 28	Blanco	£ 658
		Madera	£ 564			Madera	£ 658

Finishes

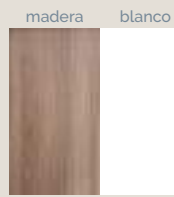

Standard sizes (cm)

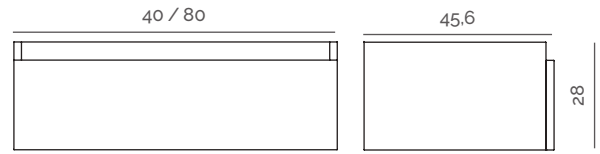

NOTE: worktop not included with Artic furniture.

NOTE: the Artic furniture can be combined with any of our countertops with central drainage. Worktops Infinity and Infinity 2 must be without tap hole.

Artic 80 for siphon

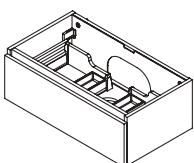

Sizes (cm)

80 x 45,6 x 28

Finish

Blanco

Madera

Price

£ 658

£ 658

Product data sheet



Installation manual





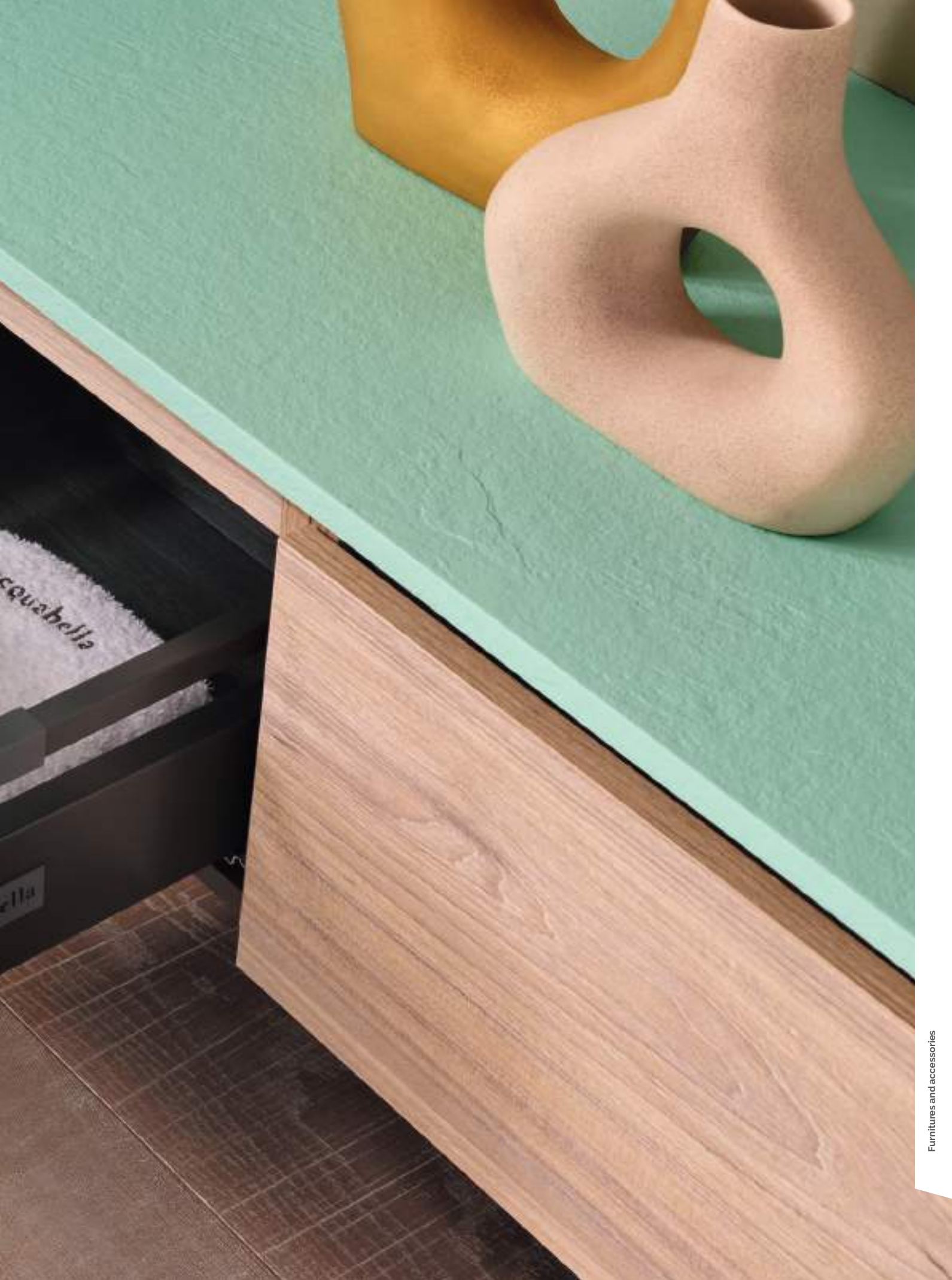



Delia furniture Slate capuccino · Delia Zero basins capuccino

Price list

	Sizes (cm)	Standard	Nat. Made	Season	RaI/NCS
	45,5 x 35,5 x 49	£264	£291	£291	£317

Textures

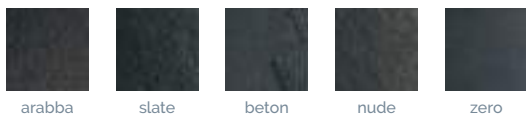

Colours

Standard

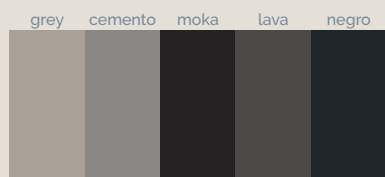
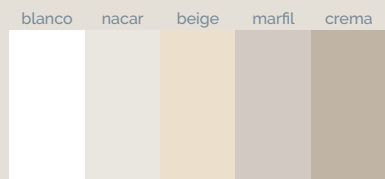

Naturally Made

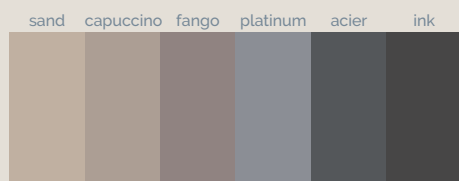

Season

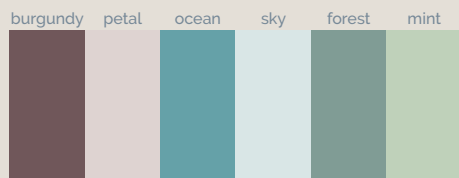

RaI/NCS



Standard sizes (cm)

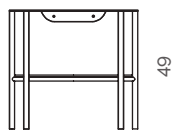
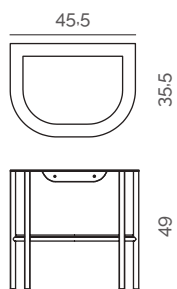

NOTE: Delia Basin not included with Delia furniture.

Product data
sheet



Installation
manual



Integra furniture



Integra 100 Slate furniture blanco · Integra SF 120 Slate worktop blanco · Urban mirror

Price list

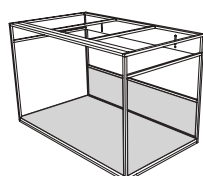

	Sizes (cm)	Standard	Nat. Made	Season	RaI/NCS
Integra 80 furniture	79,5 x 46,1 x 51	£ 1208	£ 1321	£ 1321	£ 1433
Integra 90 furniture	89,5 x 46,1 x 51	£ 1222	£ 1335	£ 1335	£ 1451
Integra 100 furniture	99,5 x 46,1 x 51	£ 1236	£ 1351	£ 1351	£ 1466
Integra 120 furniture	119,5 x 46,1 x 51	£ 1250	£ 1366	£ 1366	£ 1484

Textures

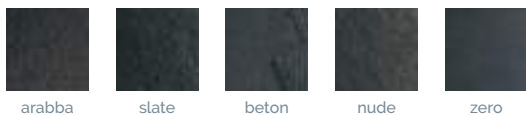

Colours

Standard

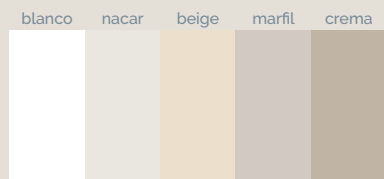

Naturally Made

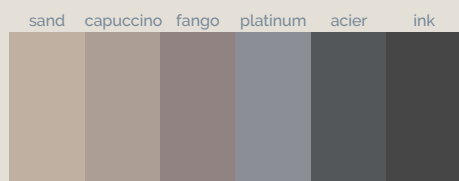

Season

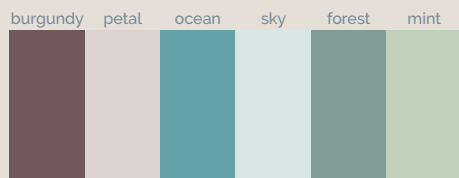

RaI/NCS



Standard sizes (cm)

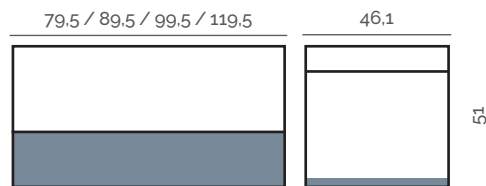

NOTE: worktop not included with Integra furniture.

Product data
sheet



Installation
manual



Integra floor standing furniture



Integra 120 Slate floor standing furniture lava · Integra SF 120 SX Slate worktop lava · Urban mirror

Price list

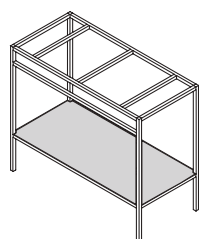

	Sizes (cm)	Standard	Nat. Made	Season	RaL/NCS
Integra 80 floor standind furniture	79,5 x 46,1 x 73/83,7	£ 1039	£ 1135	£ 1135	£ 1230
Integra 90 floor standind furniture	89,5 x 46,1 x 73/83,7	£ 1051	£ 1148	£ 1148	£ 1244
Integra 100 floor standind furniture	99,5 x 46,1 x 73/83,7	£ 1062	£ 1161	£ 1161	£ 1259
Integra 120 floor standind furniture	119,5 x 46,1 x 73/83,7	£ 1075	£ 1174	£ 1174	£ 1274

Textures

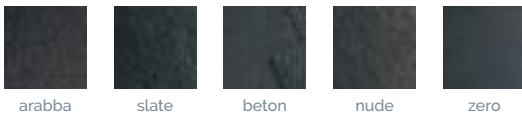

Colours

Standard

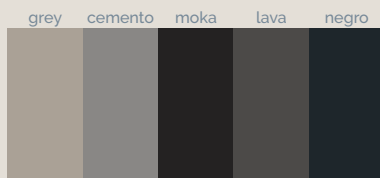
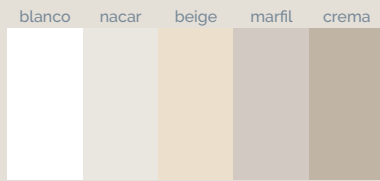

Naturally Made

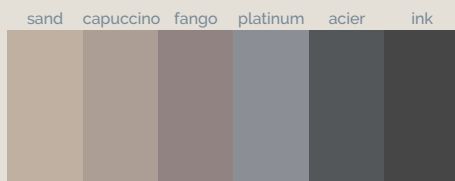

Season

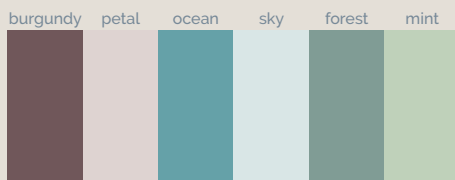

RaI/NCS



Standard sizes (cm)

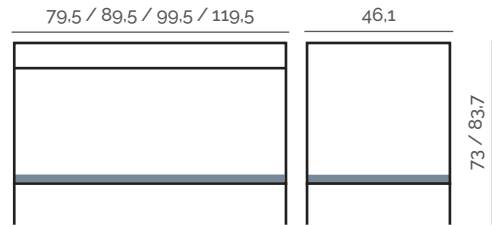

NOTE: worktop not included with Integra floor standing furniture.

Height (cm)

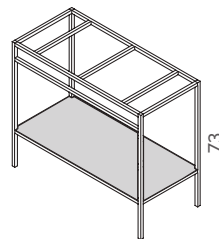

Integra CF

Integra 2 CF

Infinity CF

Infinity 2 CF

One CF

One CFR

One SF

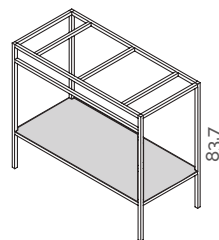

Integra SF

Integra 2 SF

Infinity CFR

Infinity SF

Infinity 2 CFR

Infinity 2 SF

Product data sheet



Installation manual



Urban furniture



Urban madera furniture 100 cm · One SF Beton worktop NCS S 3020-G10Y · On-Top Circle XL Beton basin crema · Quiz wallpanels NCS S 5020-B90G 240X120 cm · Urban mirror

Price list

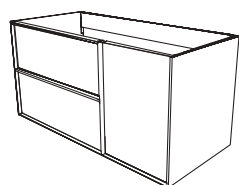

	Sizes (cm)	Finish	Price
Urban furniture 80	79 x 45,4 x 48	Blanco	£ 809
		Madera	£ 687
Urban furniture 100	99 x 45,4 x 48	Blanco	£ 894
		Madera	£ 746
Urban furniture 120	119 x 45,4 x 48	Blanco	£ 943
		Madera	£ 785

Finishes

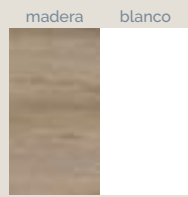

Standard sizes (cm)

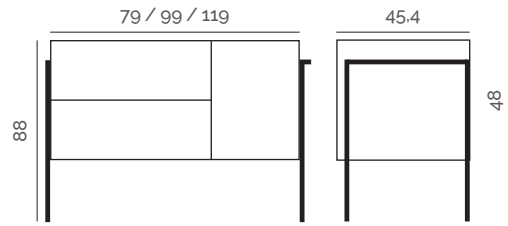

NOTE: worktop not included with Urban furniture.
 NOTE: the Urban furniture can be accompanied by any of our worktops as long as it conforms to the following parameters: length 80,100 or 120 cm - width 46 cm - dran position centered.

Complement

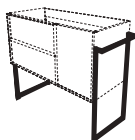

Legs + Towel rail legs rail

Finish

Black



Price

£ 401

Product data sheet



Installation manual



Show furniture



Show 80 Arabba furniture crema

Price list

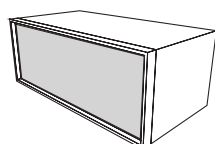

Sizes (cm)	Standard	Nat. Made	Season	RaL/NCS
80 x 42 x 29,5	£917	£1002	£1002	£1084
90 x 42 x 29,5	£987	£1078	£1078	£1169

Textures

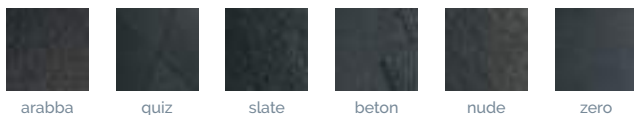

Colours

Standard



Naturally Made

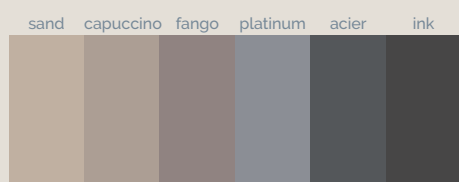

Season

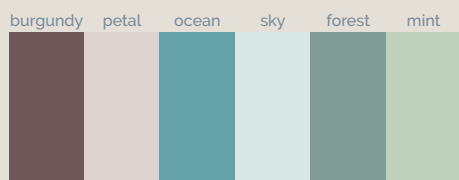

RaI/NCS



Standard sizes (cm)

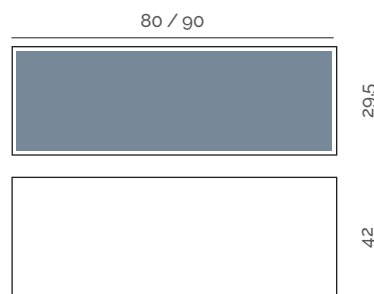

Product data sheet



Installation manual



Show closet



Show Quiz closet NCS S 3050-Y80R

Price list



Sizes (cm)

80 x 34 x 27

Standard

£792

Nat. Made

£863

Season

£863

RaL/NCS

£934

Textures



Colours

Standard

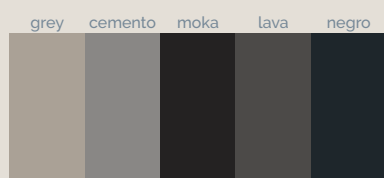
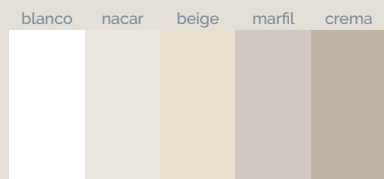

Naturally Made

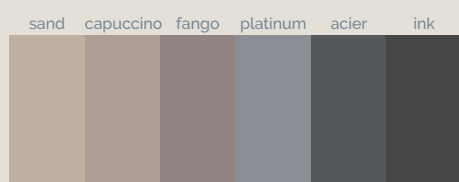

Season

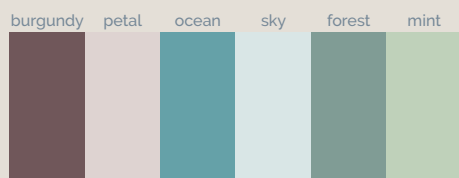

RaI/NCS



Standard sizes (cm)

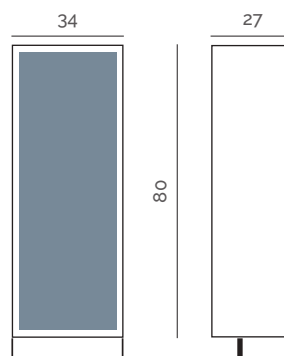

Complement

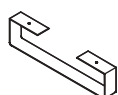

Towel rail

Finish

Black



Price

£ 95

Product data sheet



Installation manual



Show stool



Show blanco Slate stool NCS S 5540-R90B · Chrea bathtub · Hera Zero wallpanel NCS S 2050-Y 220x100 cm

Price list

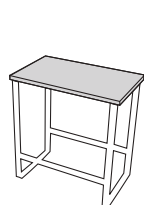

Sizes (cm)

40 x 45 x 25

Standard

£ 533

Nat. Made

£ 577

Season

£ 577

RaI/NCS

£ 623

Textures

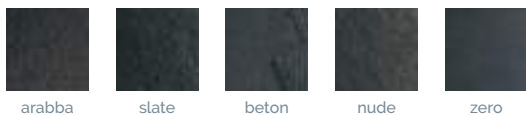

Colours

Standard

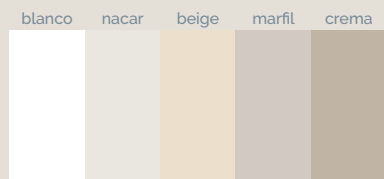

Naturally Made

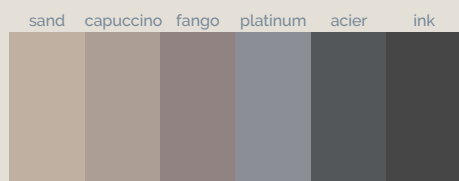

Season

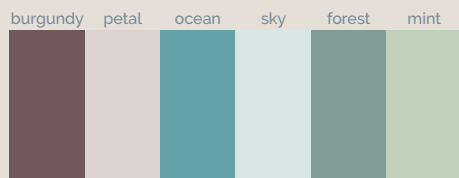

RaI/NCS



Standard sizes (cm)

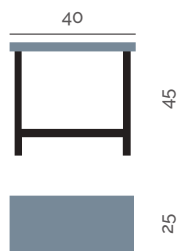

Product data sheet



Show seat wall



Show Slate seat wall blanco · Basic Slate wallpanel negro 240x100 cm

Price list

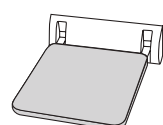

Sizes (cm)	Standard	Nat. Made	Season	RaI/NCS
30 x 28 x 1,6	£365	£394	£394	£427

Textures

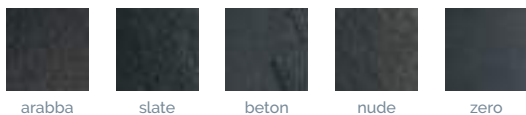

Colours

Standard



Naturally Made

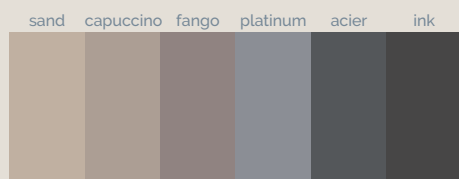

Season

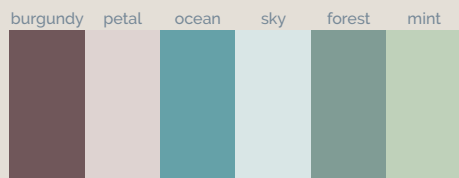

Ra/NCS



Standard sizes (cm)

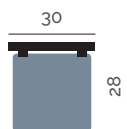

Product data
sheet



Installation
manual



Box shelf



Box Slate shelf ink · Basic Slate wallpanel platinum 250x120 cm

Price list

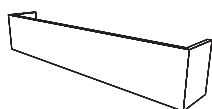

Number of hangers	Sizes (cm)	Standard	Nat. Made	Season	RaL/NCS
3	50 x 13 x 11	£ 500	£ 541	£ 541	£ 584
4	70 x 13 x 11	£ 556	£ 604	£ 604	£ 649

Textures

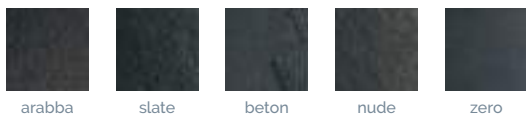

Colours

Standard

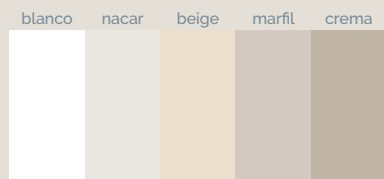

Naturally Made

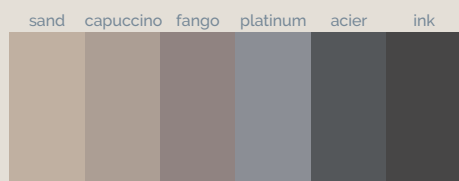

Season

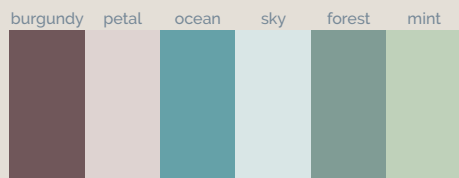

RaL/NCS



Standard sizes (cm)

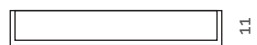
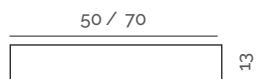

Product data sheet



Installation manual



Show shelf



Show blanco Beton shelf blanco · Basic Beton wallpanel crema 250x100 cm

Price list

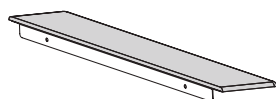

Sizes (cm)	Standard	Nat. Made	Season	RaI/NCS
51 x 11 x 0,6	£ 254	£ 270	£ 270	£ 288

Textures

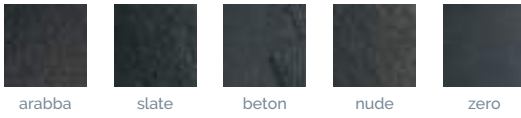

Colours

Standard

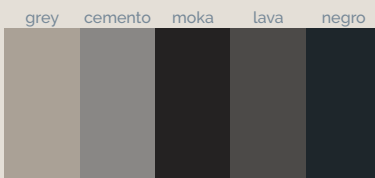
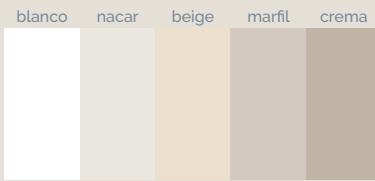

Naturally Made

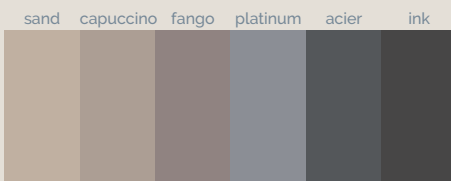

Season

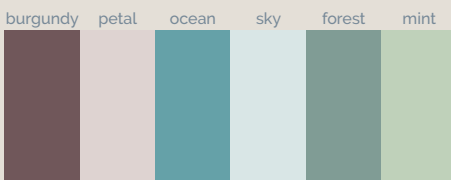

RaI/NCS



Standard sizes (cm)

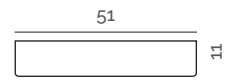

Product data sheet



Installation manual



Corner Show shelf



Corner Show negro Slate shelf lava - Basic Slate wallpanel marfil

Price list

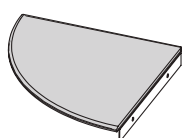

Sizes (cm)

22 x 22 x 0,6

Standard

£ 273

Nat. Made

£ 293

Season

£ 293

RaI/NCS

£ 312

Textures

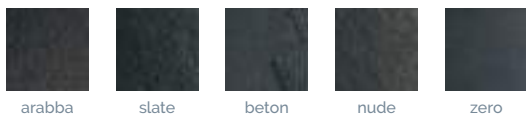

Colours

Standard



Naturally Made

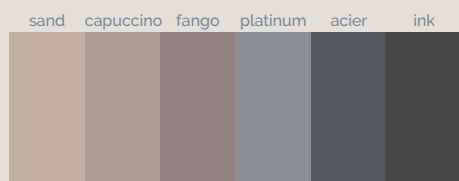

Season

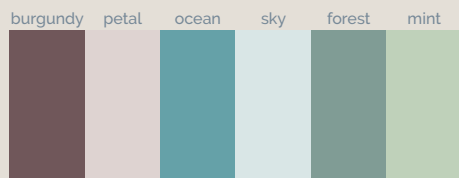

RaI/NCS



Standard sizes (cm)

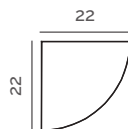

Product data
sheet



Installation
manual



Cladding for toilet



Cladding for toilet Zero negro

Price list

Standard



Sizes (cm)

124 x 54 x 10

130 x 57 x 23

Standard

£ 442

£ 442

Nat. Made

£ 478

£ 478

Season

£ 478

£ 478

RaI/NCS

£ 515

£ 515

Textures

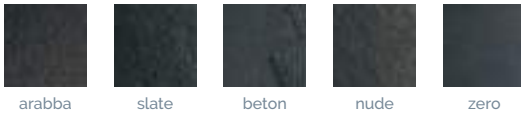

Colours

Standard

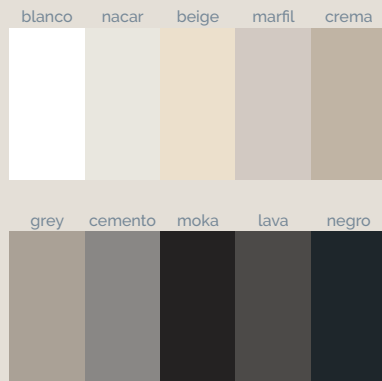

Naturally Made

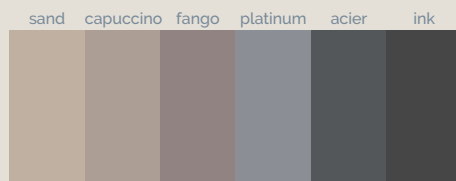

Season

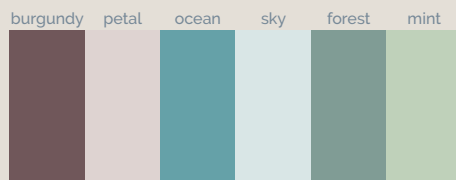

RaI/NCS



Standard sizes (cm)

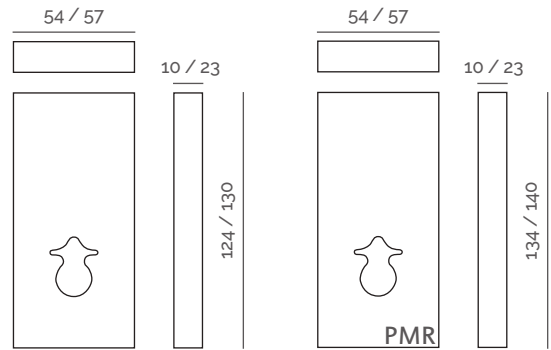

PMR

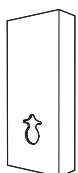

Sizes (cm)

134 x 54 x 10

140 x 57 x 23

Standard

£ 442

£ 442

Nat. Made

£ 478

£ 478

Season

£ 478

£ 478

RaI/NCS

£ 515

£ 515

Product data sheet



Installation manual



Moon mirror



Moon Slate mirror crema · Chrea basins · One CF Slate worktop crema 200x50 cm · Basic Slate wallpanels blanco 250x120 cm

Price list

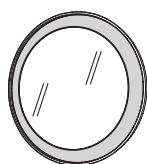

Sizes (cm)	Standard	Nat. Made	Season	Ral/NCS
Ø 80 x 4	£ 524	£ 569	£ 569	£ 612

Textures

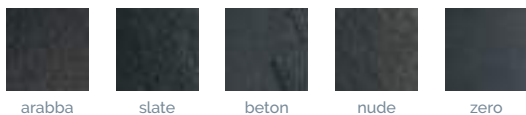

Colours

Standard

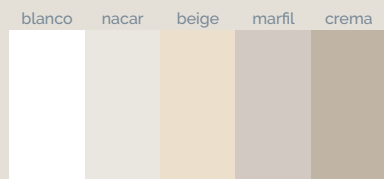

Naturally Made

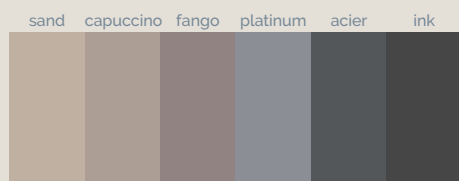

Season

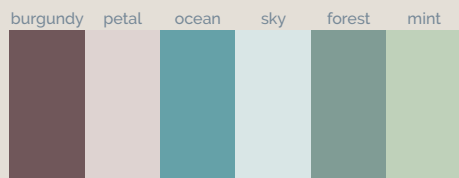

RaI/NCS



Standard sizes (cm)

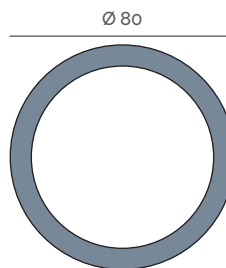

Product data
sheet



Installation
manual



Urban mirror



Urban mirrors · On-Top Rectangle XL Beton basins NCS S 3040-Y60R · One CF Beton worktop nacar 220x50 cm · Basic Arabba wallpanels sand 250x100 cm

Price list

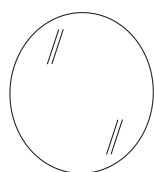

Sizes (cm)

Ø 80

Price

£180



Standard sizes (cm)

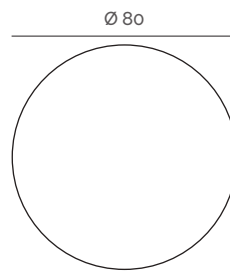

Product data
sheet



Installation
manual



Show mirror



Show Slate mirrors cemento · Basic Slate wallpanels crema 250x100 cm · On-Top Square XL Slate basins cemento

Price list

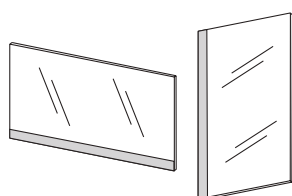

Sizes (cm)	Standard	Nat. Made	Season	Ra/NCS
80 x 50 x 2,1	£ 365	£ 394	£ 394	£ 427
100 x 50 x 2,1	£ 399	£ 438	£ 438	£ 466
120 x 50 x 2,1	£ 438	£ 477	£ 477	£ 505
100 x 40 x 2,1	£ 338	£ 363	£ 363	£ 390

Textures

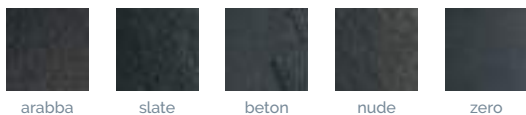

Colours

Standard

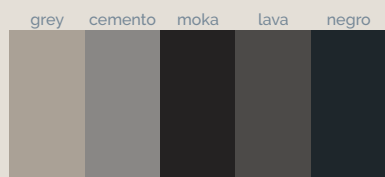
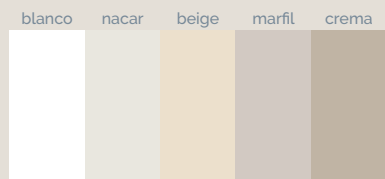

Naturally Made

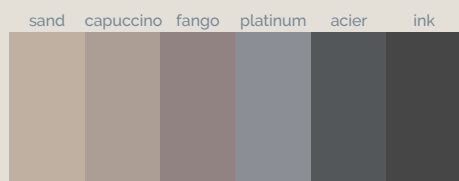

Season

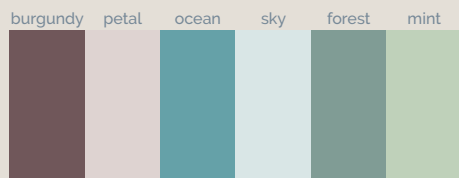

RaI/NCS



Standard sizes (cm)

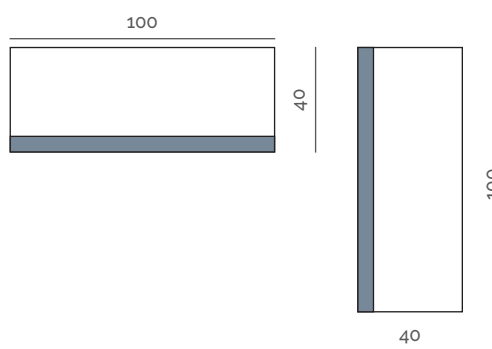
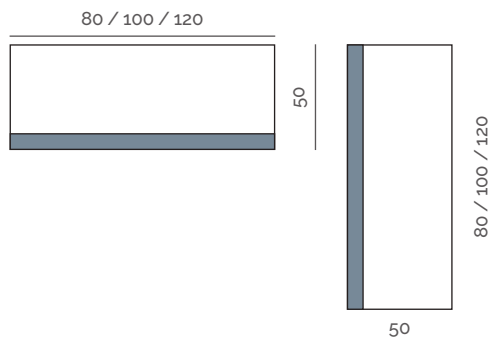

Product data
sheet



Installation
manual



Kendo shower column



Kendo Slate shower column NCS S 6010-B30G · Basic Slate wallpanels blanco 240x100 cm · Show inox Slate shelves NCS S 6010-B30G

Price list

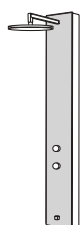

Sizes (cm)	Standard	Nat. Made	Season	Ra/NCS
135 x 22 x 8,5	£ 795	£ 867	£ 867	£ 940

Textures

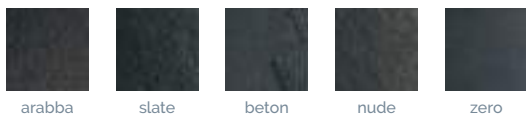

Colours

Standard



Naturally Made

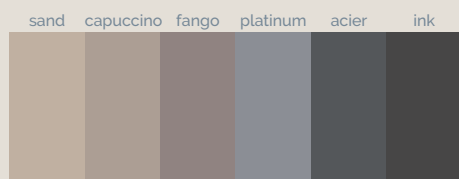

Season

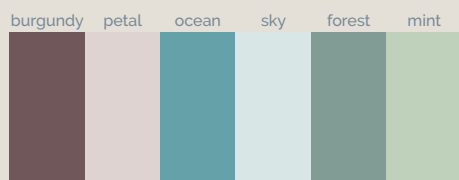

RaL/NCS



Standard sizes (cm)

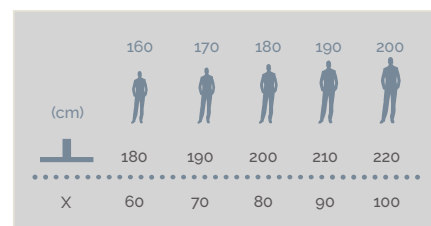
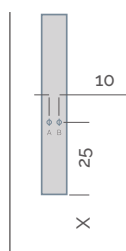
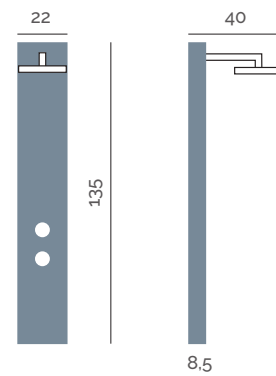

Product data sheet



Installation manual







Technical information

<i>Available traps</i>	326
<i>Available drains</i>	327
<i>Shower trays complements</i>	328-329
<i>Bathtubs complements</i>	330-331
<i>Totems complements</i>	330-331
<i>Worktops complements</i>	332-333
<i>Basins complements</i>	334-335
<i>Akron certifications</i>	336-337
<i>Dolotek certifications</i>	338
<i>Use and maintenance</i>	339
<i>Akron products characteristics</i>	339-340
<i>Repair</i>	341-342
<i>General sales conditions</i>	343-344

Available traps

SHOWER TRAYS

Standard

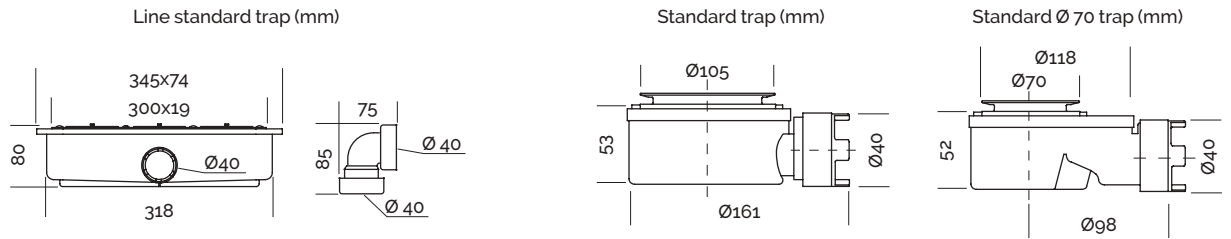

Optional

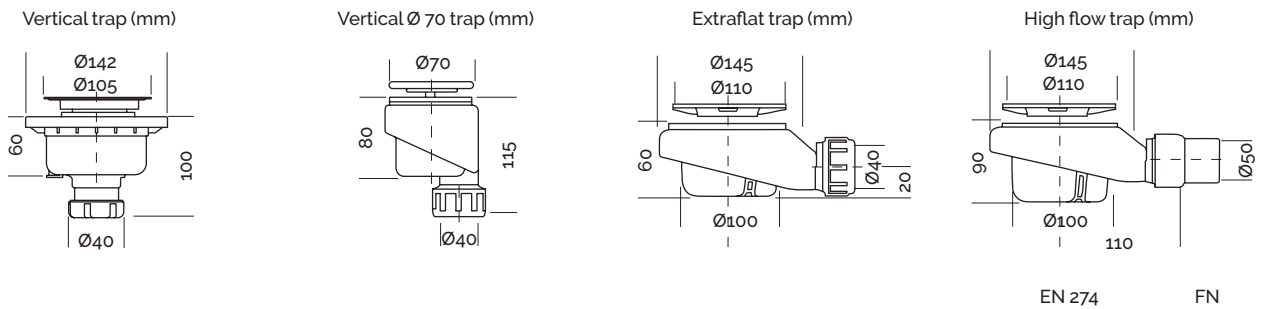

Line standard trap

Standard trap



Standard Ø70 trap



Vertical trap

Vertical Ø70 trap

Extraflat trap

High flow trap



BATHTUBS

Standard

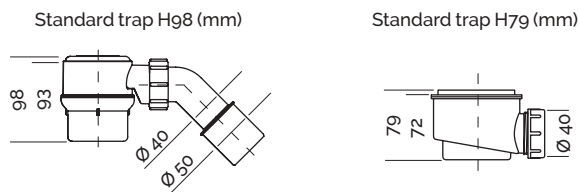

EN 274

FN

Standard trap H98



Standard trap H79



Available drains

BATHTUBS

Akron clic-clac drain (mm)

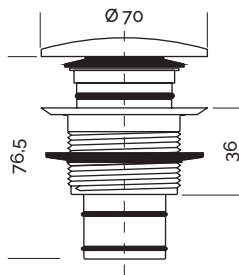

Clic-clac drain chrome (mm)

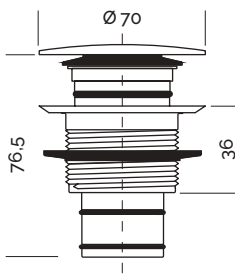

Dolotek clic-clac drain (mm)

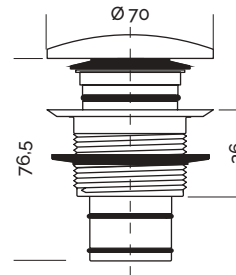

WORKTOPS, BASINS AND TOTEMS

Akron clic-clac drain (mm)

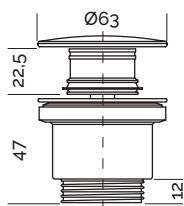

Akron free drain (mm)

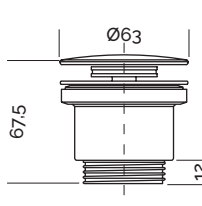

Clic-clac drain chrome (mm)

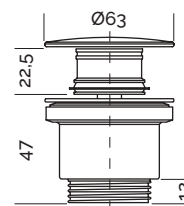

Free outlet drain chrome (mm)

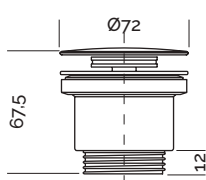

Pop Down drain chrome (mm)

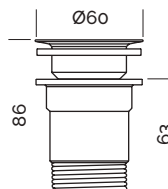

Flat drain chrome (mm)

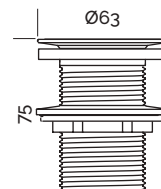

Clic-clac drain with overflow chrome (mm)

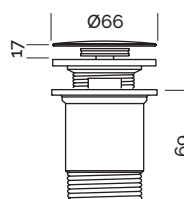

SHOWER TRAYS COMPLEMENTS



	Price	Standard	Nat. Made	Season	Ra/NCS	Base Slate	Base Beton	Base Zero	Base Nude
Line standard trap	-								
Standard trap	-					✓	✓	✓	✓
Standard Ø70 trap	-								
Vertical trap	-					✓	✓	✓	✓
Vertical Ø70 trap	-								
Extraflat trap	£ 59					🛒	🛒	🛒	🛒
High flow trap	£ 76					🛒	🛒	🛒	🛒
Frame (5x4,1 cm)		£ 1,37 cm linear	£ 1,51 cm linear	£ 1,51 cm linear	£ 1,64 cm linear	🛒	🛒	🛒	🛒
Drying area		£ 618	£ 679	£ 679	£ 741	🛒			
Skirt		£ 1,30 cm linear	£ 1,37 cm linear	£ 1,37 cm linear	£ 1,42 cm linear	🛒	🛒	🛒	🛒
Base / Arq Stainless steel grid	£ 25					✓	✓	✓	✓
Base / Arq Akron grid (Mia, Geo, Lux)	£ 70	📦	📦	📦	📦	✓	✓	✓	✓
Unic Slate Akron grid (Deco, Dune, Drop)	£ 70	📦	📦	📦	📦				
Halo Slate Akron cover	-	📦	📦	📦	📦				
Areia Slate Evo Akron cover	-	📦	📦	📦	📦				
Natur Wave Akron grid	-	📦	📦	📦	📦				
Smart Quiz Akron grid	-	📦	📦	📦	📦				
Tempo Arabba Akron cover	-	📦	📦	📦	📦				
Flow Zero Akron cover	-	📦	📦	📦	📦				
Focus Beton Akron grid	-	📦	📦	📦	📦				
Focus Beton metal ring	-								
Prisma Slate stainless steel grid	-								

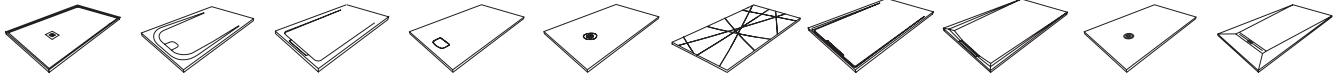

Arq Zero

Unic Slate

Halo Slate

Areia Slate Evo

Natur Wave

Smart Quiz

Tempo Arabba

Flow Zero

Focus Beton

Prisma Slate

		✓				✓	✓		
✓	✓		✓	✓	✓			✓	
									✓
✓	✓		✓	✓	✓			✓	
									✓
🛒	🛒		🛒	🛒	🛒			🛒	
🛒	🛒		🛒	🛒	🛒			🛒	
								🛒	🛒
	🛒	🛒	🛒						🛒
🛒	🛒	🛒				🛒	🛒	🛒	🛒
✓									
✓									
	✓								
		✓							
			✓						
				✓					
					✓				
						✓			
							✓		
								✓	
								✓	
									✓

BATHTUBS COMPLEMENTS



		Price	Standard	Nat. Made	Season	Ral/NCS	Blanco mate	Opal Quiz	Lech
	Akron								
	Dolotek								
	Akron clic-clac drain	-							
	Clic-clac drain white	-							
	Clic-clac drain chrome	£125							
	Dolotek clic-clac drain	-							
	Standard trap H98	-							
	Standard trap H79	-							
	Integrated overflow	-							
	Chrome overflow	-							
	Adjustable legs	-							

TOTEMS COMPLEMENTS



		Price	Standard	Nat. Made	Season	Ral/NCS	Blanco mate	Icon	Levi
	Akron								
	Dolotek								
	Akron clic-clac drain chrome/black	£59	£65	£65	£70				
	Akron free drain chrome/black	£59	£65	£65	£70				
	Clic-clac drain with overflow chrome	£76							
	Pop Down drain chrome	£76							
	Flat drain chrome	£61							
	Dolotek cover	-							
	Fixing system	-							
	Overflow	-							



Nevis

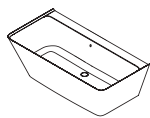

Dewa



Voss



Chrea



Levi

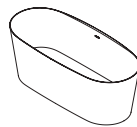

Vars

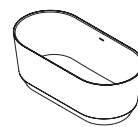

Venet



Boreal

✓	✓	✓	✓	✓	✓	✓	✓
				✓			
				🛒			
✓	✓	✓	✓		✓	✓	✓
	✓	✓	✓	✓	✓	✓	✓
✓							
			✓		✓	✓	✓
	✓	✓					
✓	✓			✓	✓		✓

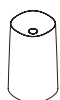

Vars

✓
🛒
🛒
✓

WORKTOPS COMPLEMENTS

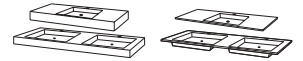

		Price	Standard	Nat. Made	Season	Ral/NCS	Blanco mate	Integra CF Integra 2 CF	Integra SF Integra 2 SF
	Akron								
	Dolotek								
	Basin 42 (30 x 42 cm)	-							
	Basin 52 (30 x 52 cm)	-							
	Basin 52 Round (30 x 52 cm)	-							
	Basin 62 (30 x 62 cm)	-							
	Basin 50 (26,7 x 50 cm)	-							
	Basin 104 (26,7 x 104 cm)	-							
	Basin 38 (23,4 x 38 cm)	-							
	Basin 55 (31,5 x 55,1 cm)	-							
	Upstand		£ 0,45 cm linear	£ 0,50 cm linear	£ 0,50 cm linear	£ 0,56 cm linear			
	Fixing system	-							
	Towel rail / Fixing system	-							
	Front towel rail Show (40 x 4 cm)	£ 163							
	Right towel rail Show (40 x 4 cm)	£ 163							
	Left towel rail Show (40 x 4 cm)	£ 163							
	Moiwa towel rail (50 x 5 cm)	-							
	Akron clic-clac drain chrome / black		£ 59	£ 65	£ 65	£ 70			
	Akron free drain chrome / black		£ 59	£ 65	£ 65	£ 70			
	Clic-clac drain chrome	£ 61							
	Free outlet drain chrome	£ 61							
	Pop Down drain chrome	£ 76							
	Flat drain chrome	£ 61							



Integra CF 120XL	Integra SF 120XL	Infinity CF Infinity 2 CF	Infinity CFR Infinity 2 CFR	Infinity SF Infinity 2 SF	One CF	One CFR	One SF	Mini	Moiwa
✓	✓	✓	✓	✓	✓	✓	✓	✓	
									✓
		✓	✓	✓					
		✓	✓	✓					
		✓	✓	✓					
		✓	✓	✓					
✓	✓								
								✓	
									✓
✓	✓	✓	✓	✓	✓	✓	✓		
✓		✓	✓		✓	✓		✓	✓
								✓	
🛒		🛒			🛒				
		🛒			🛒				
		🛒			🛒				
									✓
🛒	🛒	🛒	🛒	🛒				🛒	
🛒	🛒	🛒	🛒	🛒				🛒	
									🛒
									🛒
									🛒
									🛒

BASINSCOMPLEMENTS

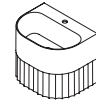

		Price	Standard	Nat. Made	Season	Rd/NCS	Blanco mate	Delia	On-Top Circle
	Akron								
	Dolotek								
	Akron clic-clac drain chrome / black	£59	£65	£65	£70				
	Akron free drain chrome / black	£59	£65	£65	£70				
	Clic-clac drain chrome	£61							
	Free outlet drain chrome	£61							
	Dolotek clic-clac drain chrome	-							
	Pop Down drain chrome	£76							
	Flat drain chrome	£61							
	Dolotek cover	-							



		Price	Standard	Nat. Made	Season	Rd/NCS	Blanco mate	Levi Circle XL	Levi Rectangle
	Akron								
	Dolotek								
	Akron clic-clac drain chrome / black	£59	£65	£65	£70				
	Akron free drain chrome / black	£59	£65	£65	£70				
	Clic-clac drain chrome	£61							
	Free outlet drain chrome	£61							
	Dolotek clic-clac drain chrome	-							
	Pop Down drain chrome	£76							
	Flat drain chrome	£61							
	Dolotek cover	-							



On-Top Circle XL



On-Top Square



On-Top Square XL



On-Top Oval



On-Top Oval XL

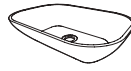

On-Top Rectangle



On-Top Rectangle XL



Chrea

✓	✓	✓	✓	✓	✓	✓	
							✓
🛒	🛒	🛒	🛒	🛒	🛒	🛒	
🛒	🛒	🛒	🛒	🛒	🛒	🛒	
							✓



Levi Rectangle XL



Vars Circle



Vars Circle XL



Vars Square XL



Vars Rectangle XL



Venet Circle



Venet Circle XL



Venet Square



Venet Rectangle

✓	✓	✓	✓	✓	✓	✓	✓	✓
🛒					🛒	🛒	🛒	🛒
🛒					🛒	🛒	🛒	🛒
🛒	🛒	🛒	🛒	🛒	🛒	🛒	🛒	🛒
🛒	🛒	🛒	🛒	🛒	🛒	🛒	🛒	🛒
	✓	✓	✓	✓				

Akron certifications

QUALITY MANAGEMENT SYSTEM CERTIFICATE

Management system of	Businesses	Result	Standard
Construplas, S.L.U.	Design, manufacture and sale of shower trays and bathroom accessories	✓	ISO 9001:2015
	Design, manufacture and sale of shower trays	✓	ISO 14001:2015
	Design, manufacture and sale of shower trays. Design and sale of bathroom accessories	✓	ISO 45001:2018

ASSESSMENT OF COMPLIANCE OF SHOWER TRAYS FOR HOUSEHOLD USE *

Product	Test	Result	Standard
Shower tray	Cleanability	✓	UNE EN 14527:2016 + A1:2019
	Stability of the bottom	✓	
	Chemical resistance	✓	
	Resistance to temperature changes	✓	

* Under UNE-EN 14527:2016 + A1:2019, domestic use includes use in hotels, student residences, hospitals and similar premises.

DETERMINATION OS ANTI-SLIP PROPERTIES

Product	Test	Realised	Standard
Shower tray	Critical angle of slip. Unshod wet areas	✓	UNE EN 16165:2022 Annex A

FUNCTIONAL REQUIREMENTS FOR SANITARY FITTINGS

Product	Test	Result	Standard
Worktop	Load resistance	✓	UNE EN 14688:2016 + A1:2019
	Water crainage	✓	
	Resistance to temperature changes	✓	
	Resistance to chemicals and dyes	✓	
	Cleanability	✓	

ASESSMENT OF COMPLIANCE OF DOMESTIC BATHTUBS

Product	Test	Result	Standard
Bathtub	Cleanability	✓	UNE EN 14516:2017 + A1:2019
	Stability of the bottom of the bathtub	✓	
	Resistance to chemicals and dyes	✓	

CHEMICAL AGENTS TEST

Type	Reagent	Result	Standard
Acids	Acetic acid (CH ₃ COOH) 10% v/v	✓	UNE EN 14527:2016 + A1:2019
Alkalis	Sodium hydroxide (NaOH) 5% v/v	✓	
Alcohols	Ethanol (C ₂ H ₅ OH) 70% v/v	✓	
Bleaching agents	Sodium hypochlorite (NaOCl) 5% of active chlorine (Cl ₂)*	✓	
Staining agents	Methylene blue 1% m/m	✓	

*The decolorant specified above may be replaced by sodium percarbonate (2Na₂CO₃ · 3H₂O₂) prepared as follows: Dissolve 1 g of a commercially available powdered sodium percarbonate-based decolorant containing 15% to 30 % of the active component in 100 ml of deionised water at room temperature.

Dolotek certifications

DECLARATION OF PERFORMANCE NUMBERS - REGULATION (UE) N° 305/2011 ANNEX III *

Product	Basic characteristic	Result	Standard
Basin / Totem / Worktop	Cleanability	✓	EN 14688:2006 DoP: 400/04/13
	Load resistance		
	Drain		
	Durability		

Product	Basic characteristic	Result	Standard
Bathtub	Cleanability	✓	EN 14527:2006+A1:2010 DoP 402/02/13
	Durability		

* Tests were conducted by the Construction Technology Institute, member of the European Organisation of Technical Assessment (EOTA).

RESISTANCE TO FIRE *

Property	Classification	Classification criteria	Study method	Standard
European classification for the reaction to fire behaviour	E	$F_s \leq 150\text{mm}$ in 20 s	EN ISO 11925-2L 15 s of exposure	EN 13501-1:2007 A1:2009

* Tests were conducted by the Construction Technology Institute, member of the European Organisation of Technical Assessment (EOTA).

RESISTANCE TO TEMPERATURE CHANGES *

Product	Conforming document	Result	Standard
Basin / Totem / Worktop	LZE03-01224/17/R31NZE	✓	European Standard EN 14688
Bathtub	LZE03-01224/17/R31NZE	✓	European Standard EN 14516

* Tests were conducted by the Construction Technology Institute, member of the European Organisation of Technical Assessment (EOTA).

RESISTANCE TO CHEMICAL REAGENTS AND DYES *

Type	Reagent	Removal method	Efect	Result	Standard
Acids	Acetic acid (CH ₃ COOH) 10% v/v	Deionised water	No discolorations (stains) or damage to the usable surface were established	✓	EN 14688:2066
Alkalis	Sodium hydroxide (NaOH) 5% v/v			✓	
Alcohols	Ethanol (C ₂ H ₅ OH) 70% v/v			✓	
Bleaching agents	Sodium hypochlorite (NaOCl) 5% of active chlotine (Cl ₂)			✓	
Staining agents	Methylene blue 1% m/m			✓	
Salts	Sodium chloride (NaCl) 170 g/l, diluted with water to 50%			✓	

* The test was conducted in accordance with the description in item 5.5 of the EN 14688:2006 European Standard using all the chemical reagents provided in Table 2 of this document.

Use and maintenance

AKRON

To enjoy your shower tray for years, please follow this simple tips:

For routine cleaning simply rinse with a mild (non-abrasive) cotton dish cloth with water. NEVER USE PADS (SCOTCH BRITE or NATURAL FIBER) no SOLVENTS , ACID, ALKALI OR ABRASIVE . After using any cleaner it is necessary to rinse abundantly with soap and water in order to remove any traces of cleaning products. Ensure sufficient ventilation of the bathroom.

Avoid contact with lacquer, nail polish remover , organic solvents , alcohols , acids, Alkalis,etc.

If you are going to use hair dyes, rinse the shower tray with water and soap when finished.

To remove any traces of lime that can stay in the panel , use a limescale cleaner (Viakal) lowering 1:3 with water (1 L Viakal by 3 L of water) as follows:

- Apply with a wet cloth over the entire surface.
- Leave on for 15 minutes and after that time rinse thoroughly.
- Place the grid again and rinse the shower tray with water again.
- Not recommended for outdoor use.

DOLOTEK

To enjoy your product for many years to come, follow these simple tips:

1. For regular cleaning, we recommend universal, non-abrasive cleaning products.
2. After each use, rinse the inner surface with water and dry with a cotton cloth. Do not use synthetic or microfibre cloths as they may scratch the surface.
3. To remove limescale, use vinegar diluted with water.
4. Clean stubborn stains with warm water and mild

ATTENTION: We recommend using a green pad (Scotch Brite or similar) or an abrasive sponge only in the case of superficial scratches or persistent stains. Do not use it over the logo.

Akron products characteristics

PACKING AND SHIPPING CONDITIONS

All Akron shower trays are individually packed in a wood box according to the shower tray measures. Box contains shower tray completely protected and also: 1.- Installation instructions in different languages. 2.- AISI 304 stainless steel grid. High precision laser cut and polished, exclusive design from ACQUABELLA. Ready to install over trap. 3.- All our shower trays are supplied with a high quality syphonic shower trap (waste) according to the European standards.

Claims for damage are not accepted once the POD is signed.

USE AND MAINTENANCE CONDITIONS

A correct care of your AKRON shower tray from ACQUABELLA will let you enjoy it for many years. On a daily routine basis, a simple water wash out and a good ventilation of the bathroom is enough.

When a more thorough cleaning is needed, cleaning must be performed only with water, regular house cleaning soap and a NON abrasive sponge. DO NOT USE any kind scourer or scrubber.

AVOID USING CLEANING PRODUCTS CONTAINING SOLVENTS OR ACIDS. DO NOT USE ANY KIND OR ABRASIVE PRODUCT OR CLOTH.

It is most important to protect the shower tray against possible hits and scratches during the installation process. A cardboard sheet is also provided in the box for this purposes.

Using this protective cardboard will also help to avoid mortar, cement, adhesive or even painting remains to stain shower tray. We strongly recommend to protect shower tray during the installation process.

Please be especially careful with the special cement grouts used for ceramic tiles or stone. These products usually contain lime, sands and resins and if they end drying on the shower tray surface, this results in a stain difficult to clean. To avoid letting these products fry on the shower tray surface, wash out it with regularly and with plenty of water and leave the shower tray without any residue. SO, PROTECT WITH CARTON BOARD AND RAISE WITH WATER ANY RESIDUE BEFORE IT DRIES.

In case mortar or cement grout have finally stained the shower tray, FILA DETERDEK should be used at the end of the work.

SPECIAL SHOWER TRAY

ACQUABELLA Akron shower trays, with the exception of the Arq and Flow models, can be supplied made to measure.

When cutting to exact size, we perform straight cuts. It is not possible to cut arc, bends or curved shapes.

When ordering a "cut to size" ACQUABELLA Akron shower tray it is important: 1/ Indicate the final length of the shower tray in cm (if you wish to cut in length). 2/ Indicate the final width of the shower tray in cm. (If you wish to cut in width). 3/ Draw a sketch of the exact required sizes and shape of the shower tray.

On written request, the cut side can also be ordered painted on the same colour of the shower tray, but please note, the cut side always loses the texture.

INSTALLING REPLACING PANELS AND ELEVATION SUPPLEMENTS

ACQUABELLA Akron shower tray completes its line with replacing panels to attach to the bathroom wall and also elevation supplements. These products are available on request.

Akron products can be cut using circular saws or grinding machines with diamond discs, as those usually used building.

Fixing of the various elements must be carried out using ULTRABOND or similar and sealing with non-acidic silicone.

REPAIRING AN ACQUABELLA AKRON SHOWER TRAY

In most cases it is possible to repair the surface of a shower tray deteriorated by on improper use. A repair kit is available. This kit must be ordered specifying the colour of the shower tray to repair.

To apply the polyurethane repair lacquert, first apply cleaning alcohol to the area to remove dirt and grease. Apply paint with a small paint roller. Leave 48/72 hours for proper drying, do not touch the area while drying, do not use the shower tray in this time.

FREQUENT ASKED QUESTIONS (FAQ'S)

- What tool to use for cutting Akron shower tray or panels?

Circular saw with diamond disc, similar to those use for cutting stone, ceramic tiles, etc.

- What cleaning products can be used for AKRON shower trays and worktops?

To clean any traces of glue and cement mortar joints use a descaler called Fugasoap (KERAKOLL), DETERDEK from FILA brand, because it is specific for the removal of debris from construction works, also used for the removal of other components such as salt, rust and lime, please read the instructions. DO NOT RUB, let the product act; NEVER USE PADS (SCOTCH BRITE, or NATURAL FIBER) nor SOLVENTS, ACID, ALKALI OR ABRASIVE. After cleaning, rinse thoroughly and ensure sufficient ventilation of the bathroom. It is not dangerous for the user and not dangerous for the environment

- What are the shower trap (waste) valve characteristics?

The included shower trap (waste) is a top brand one. It is a syphonic trap, with its odour sealant effect the European quality norms. It is equipped with an easy cleaning system, just remove the Acquabella stainless steel grid and you will see a handle, pull the handle and remove the piece, clean it and replace it.

This piece is key in the syphonic effect, so, if there is a second syphonic shower tray installed in the bathroom, you must remove the piece from the shower tray, if not, water will not drain.

- What products can be used to fix and install shower trays or panels?

The bonding of the various elements must be done using SIKAFLEX (SIKA), SUPERFLEX (KERAKOLL) and sealing with grouting ceramic material or silicone nonacidic.

- What is the thickness of replacing panels?

The panels are 6 mm thick. 3D: Min 6mm, Mâx:10mm.

- Where to order spare parts or repairing kits?

You can order spare parts like shower traps, stainless steel grid, repairing kits, instructions and installation leaflets, etc. Please address to ACQUABELLA commercial department, they will be pleased to give you a quotation and fulfil your requests.

- Is any promotion material available for ACQUABELLA Akron shower trays?

Yes, to properly promote and exhibit ACQUABELLA Akron shower trays, there is a special exhibitor unit, ready to show two shower trays. Shower trays can be chosen of any texture and colour.

Repair

AKRON REPAIR KIT

Follow instructions for a correct use of our Akron repair kit:

ADEQUACY ZONE TO REPAIR:

1. Clean the surface of the shower tray very well. It can be applied for meths or acetone diluted in water with a lint-free cloth.
2. Surface must be totally clean and dry
3. Secure with bodybuilder tape or similar susceptible stain areas (tiles, screens, etc.)

APPLICATION:

4. Open the can and the bottle.
5. Put the coloured lacquer and catalyst on a small painter plastic bucket and mix.
6. Use a little roller to paint 8 or 10 cm. good quality, doing long strokes and always in the same direction, reiterating if necessary. It is important not release lint remains.
7. Depending on the state of the area to restore, you may need to apply several hands of painting. This allow to dry between them at least 40 minutes before applying the next coat.
8. Finally let dry 48 hours before removing the masking tape protection.



Akron repair kit



Price

£ 60

NOTE: a kit covers a maximum area of 140x100 cm.

AKRON MINI REPAIR KIT

It is possible to repair small defects caused in an Acquabella AKRON shower tray. If for any reason the surface has been damaged due to improper installation or accidental damage you can now order a MINI restoration kit. Just specify the finish and the colour of the shower tray to be repaired. THE KIT CONSISTS OF A CONTAINER AND IT IS INTENDED FOR SMALL REPAIRS TO THE SURFACE. CAUTION: SMALL TONALITY VARIATIONS MAY DIFFER FROM THE ORIGINAL COLOUR.

Procedure for shower tray repair:

1. Clean the shower tray surface in depth. You can use a combination of alcohol or acetone diluted with water. Clean using a soft lint-free cloth.
2. The surface must be completely clean and dry before starting.
3. Carefully open the container and ensure that the paint is properly mixed.
4. Use the brush provided to paint the surface to be repaired.
5. Leave to dry for a minimum of 48 hours.



Mini repair kit



Price

£ 32

PUTTY REPAIR KIT

INSTRUCTIONS FOR THE SURFACE REPAIR OF AN ACQUABELLA AKRON SHOWER TRAY

It is possible to repair the surface of an AKRON shower tray by Acquabella if for some reason the surface of the tray has deteriorated due to improper use. In these cases, you can request a putty repair kit. The kit consists of two containers, A and B. Procedure for repairing a shower tray:

ADEQUACY ZONE TO REPAIR:

1. Clean the surface of the tray very well. It can be applied to this process rubbing alcohol or acetone diluted in water with a soft cloth that does not leave any kind of lint.
2. The surface must be completely clean and dry.
3. Dimension the area to be repaired with masking tape or similar.

APPLICATION:

4. Open the containers.
5. Mix the components of containers A and B on a putty knife.
6. Extend the putty on the surface to be repaired.
7. Allow to dry for 30 minutes, at approximately 20°C. Once dry remove the bodybuilder's tape.
8. Simulate the texture of the tray with a sandpaper. Remove dirt and clean the area.
9. Paint the tray with a Repair Kit. From this point follow the instructions in the Repair Kit manual.



Putty repair kit



Price

£ 21

DOLOTEK REPAIR KIT

This kit can be used to repair damage and scratches. We recommend that it is applied by a professional. The kit contains all the components required to carry out the repair and to guarantee professional quality and finish.

Preparation of the area to be repaired:

1. Remove loose debris from the damaged surface with the help of a cutter or sharp tool. Apply burning alcohol to remove any loose powder, using a cotton cloth that does not leave any lint.
2. The surface must be completely clean and dry.
3. Protect the perimeter area of the damaged section with masking tape.

Directions for use:

1. Protect your hands with gloves and wear a mask.
2. Pour canister B (Pipette) into canister A and stir with the spatula for about 30 seconds until everything is well mixed.
3. Apply the mix immediately to the damaged surface using the spatula. You must apply excess material, leaving more than enough. Leave to dry for at least 6 hours
4. Remove the masking tape and wet the sandpaper before use. First use the red sandpaper with the white block as a support to sand the damaged surface in small circles. Then repeat the same process using the grey sandpaper.
5. For an improved final finish, give the entire surface a light once-over with a green scourer (Scotch Brite or similar).

*The Repair Kit has an expiration date of 3 months from the date on the package.

ATTENTION: There may be slight variations in shade from the original colour. Repair Kits should be stored in a cool, dry place and out of the reach of children.



Dolotek repair kit



Price

£ 49

General sales conditions

These general sales conditions are applicable to all orders and/or contracts, and so, they are considered to be known and accepted by the buyer when sending the purchase order.

PRICES

Our retail prices may vary after notification of the buyer. The new prices will apply to all orders placed from the date of modification onwards. The tax rate currently in force, V.A.T. and any other tax required by law will be applied to the invoice and net prices.

In the case that the goods are delivered by us in accordance with the purchase conditions agreed with the client, this will be for orders of 250 euros net minimum purchase. Below this amount, we will charge a minimum of 50 euros for shipping.

VALIDITY PERIOD

This price list is valid from September 2023 and until further notice. This present price list cancels all previous price lists and it is subject to modification without any prior notification by Construplas S.L.U.

CATALOGUES, OFFERS AND ORDERS

The terms and conditions of our catalogues are provided for informational purposes only.

Orders are considered confirmed from the moment they are received; changes, modifications and cancellations are not considered detrimental. By placing an order with Construplas S.L.U., you accept all the general terms and conditions of sale related to this price list. The discounts that will be applied to sales of our products will be made according to the conditions established with each client. Offers are always, and for all purposes, subject to our subsequent acceptance of the relevant written order.

ORDER MODIFICATIONS AND / OR CANCELLATIONS

No cancellations, neither modifications on orders will be accepted once items have entered production, and in any case, after 24 hours from reception of the order. All order modifications and or cancellations must be sent to Construplas S.L.U. in writing.

RETURNS

No returns are accepted without prior authorization in writing issued by Construplas S.L.U. Merchandise return will be admitted when they have been previously communicated and accepted by our Sales department. Merchandise must be returned to our premises in Vall de Uxó (Castellón) in perfect condition, on arrival Construplas S.L.U. will deduct from invoiced amount of the goods a percentage not less than 30% for reception, test, inspection, and depreciation costs. Once return has been accepted, no credit will be issued until reception, inspection, test and evaluation of the has goods been made by Construplas S.L.U.

SPECIAL - NON STANDARD ITEMS

Items with special measures, sizes or characteristics, different to those shown in this price list, will always have to be checked by our Sales Personnel. Our Sales Department is ready and please any clarification, doubt or question that arises.

TECHNICAL INFORMATION AND CHARACTERISTICS OF THE PRODUCTS

All technical information in this price list is simply illustrative. Construplas S.L.U. reserves its right to change and / or modify any characteristic or feature of any provided if does not affect to the essential features of the product.

DIMENSIONAL TOLERANCES

Due to the nature of raw materials and manufacturing process of our Akron products, these can have a $\pm 0.5\%$ dimensional tolerance respect to the real required dimensions. For our Dolotek products, these may have a tolerance of $\pm 1\%$ with respect to the actual dimensions requested.

DELIVERY TERM

All orders received are confirmed via mail or fax with an illustrative delivery term. No claim of any kind will be accepted based on delays on these delivery terms.

INSTALLATION AND ASSEMBLING

Proper assembling and installation of our products are required. These must be made by qualified personnel and following instructions leaflets supplied with our products. Invalid installation and/or assembling will result in guarantee voiding.

CONDITIONS OF PAYMENT

To negotiate.

LITIGATIO / CONTROVERSIES

Construplas S.L.U. will is to solve any kind controversy that shall arise with our customers on friendly basis. But in case this is not possible, in case of litigation, or controversy between the parties in relation with the interpretation and / or accomplishing of the contract and / or these "GENERAL SALES CONDITIONS", both parties submit themselves to an arbitration in equity according to the Arbitration Law December 5th 1998 of the Kingdom of Spain, waiving whatsoever other jurisdiction they many have to right to.

GUARANTEE GENERAL TERMS

Commercial Guarantee ("CG"), offered by Construplas S.L.U. only applies to products bought in member countries of the European Union ("UE"). Products sold in non EU countries are not under this CG unless written agreement with Construplas S.L.U.

This CG does not affect consumer rights under the Directive 1999/44, and the according national transposition Laws of the UE countries.

Construplas S.L.U. guarantees its products and components against any unconformity only if they have been properly installed (according to the regulations and following the instructions) and if the products have been used on a normal basis and as they were conceived for. If the lack of conformity is notified to Construplas S.L.U. in the following 2 months from the knowledge of the unconformity, the validity period of the commercial guarantee for the en user will be 2 years from the date or purchase, proven by the purchasing invoice.

An exception to the regular terms of the CG rules for all products and items than have been exhibited in showrooms or salerooms of any kind as a distributor, retailer, developer, builder, etc. In this cases, the period of CG in one year from the date or purchase, proven by the purchasing invoice.

The bearer of this CG must prove its validity by the purchasing invoice of the product or by the purchasing deed of the house, apartment, etc. where the products are installed.

This commercial guarantee DOES NOT cover:

- Damages caused by transport (except if transported by Construplas S.L.U.), damages caused by incorrect installation or assembling, damages caused by repairs or manipulation performed by personnel non authorized by Construplas S.L.U.
- Damages caused by dirt, incrustations, lime, calcination and other physical, chemical or electrochemical defects.
- Damages not objectively attributable to the manufacturer.

IMPORTANT NOTE ON GUARANTEE ON SHOWER TRAYS

Construplas S.L.U. guarantees the shower tray against any manufacturing defect and undertakes to substitute the defective shower tray by new one or the to repair it.

Before finishing ceramic tile installation, and BEFORE installing any other material on or around the Shower tray, the installer must verify the correct installation, specifically levelling and drainage. If these verifications are not performed correctly, Construplas S.L.U. will NOT accept any expenses on the shower enclosures or tiles installed on or around the shower tray.

Construplas S.L.U. will not be responsible for the construction costs derived from the replacement of the shower tray.

The colours, information, weight and descriptions contained in this catalogue are used as a guidance. The aspect of the material can vary slightly from the one showed in the photographs.
Construplas, S.L.U. keeps the right to add without previous notice and at any time or for any motive, all the modifications that should consider appropriate.
Any reproduction, partial or total not authorised remains totally prohibited. The above mentioned violation will be prosecuted by the law.

CONSTRUPLAS S.L.U. Pol. Ind. Belcaire Calle C Parcela 1201 · CP.12600 Vall d'Uixó (Castellón) España Tel. +34 964 66 19 19 Fax. +34 964 69 60 84 acquabella@construplas.com

V. 2023

