

Theoretic Mass(kg)	Revision
Surface Area(dm ²)	A4

Thread	Hole	Shaft

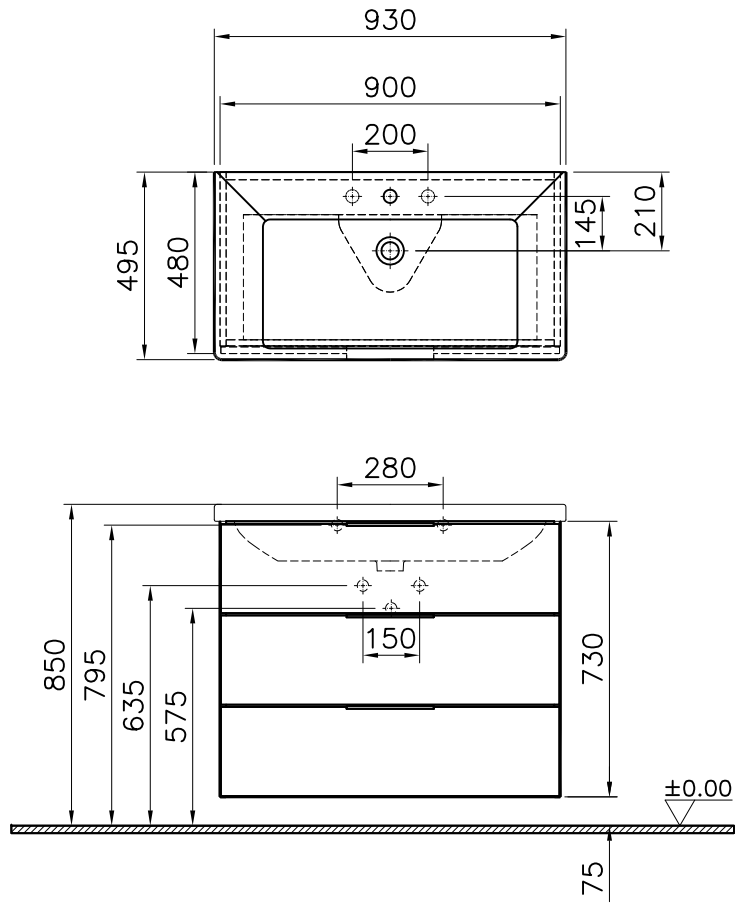

Luxury Bathroom Solutions

R.S	Description	Date	G.GULTER NAME

1	1	Washbasin Unit	60028		
item	Quantity	Part Name	Drawing No	Material	Material Class
		Series	Material	Material Class	
		Central	Washbasin Unit		
Drawn By	Controlled By	Approved By	Date	Drawing No	Scale
G.GULTER	G.CAN	B.KIRAN	16.03.2015	60028	1/20
					VitrA® ART ^{EM} A

This drawing can only be used for the intended purposes. Unauthorized copying is strictly prohibited.