

KIUB

KSCG100 + KI100DX

HIDRA

STRUTTURA 100 - COMPOSIZIONE 1 cassetto + griglia LAVABO ESCLUSO

Structure 100 + drawer + grate shelves
Washbasin not included

STRUTTURA IN METALLO VERNICIATO
STRUCTUR MADE IN PAINTED METAL



VISTA FRONTALE / FRONT VIEW

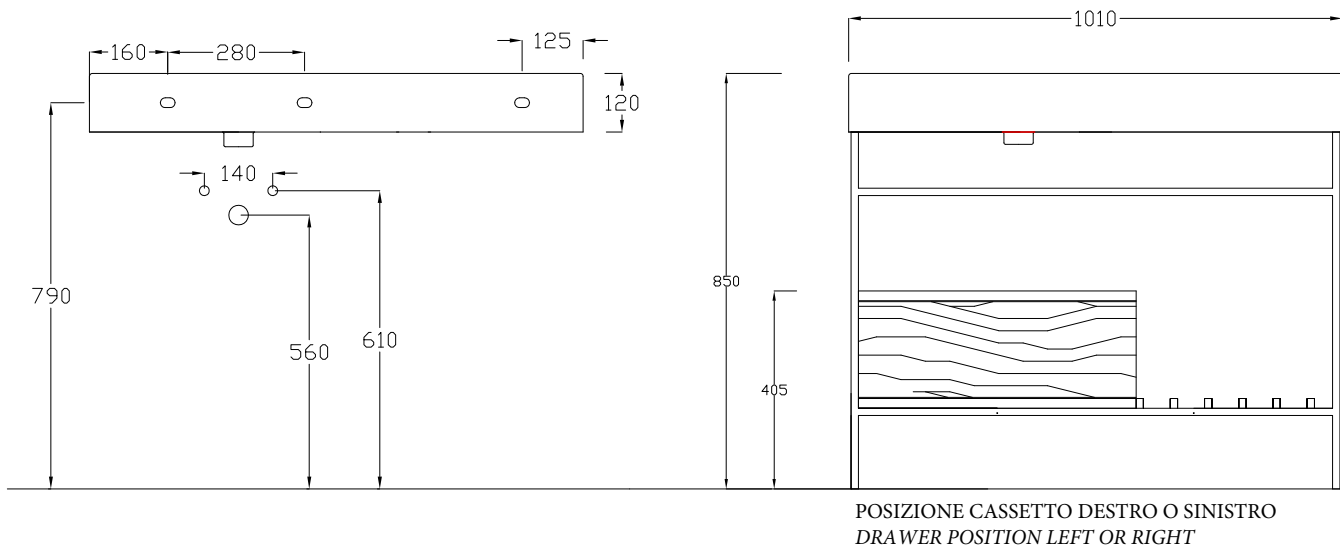

VISTA LATERALE / SIDE VIEW

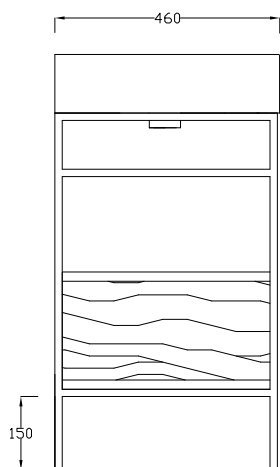

CASSETTO / DRAWER

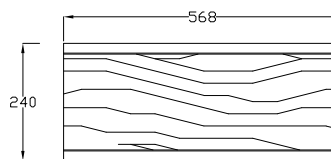

SISTEMA APERTURA PUSH PULL
PUSH PULL SYSTEM

GRIGLIA / SHELF

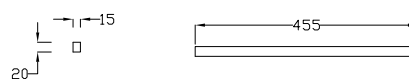

ATTENZIONE:
Le misure possono subire delle variazioni, dovute ad usura stampi e a variazioni delle caratteristiche delle materie prime che compongono l'impasto. Hidra si riserva il diritto di apportare in qualsiasi momento modifiche tecniche, costruttive e dimensionali utili al miglioramento della produzione. Consultare www.hidra.it per eventuali aggiornamenti.

ATTENTION:
Size could change for the use of the moulds or for the changes of first material used in the mixture. Hidra reserves the right to make at any time technical, construction and dimensional changes, useful to improve production. Consult www.hidra.it for updates

STRUTTURA 100 - COMPOSIZIONE 1 cassetto + griglia
LAVABO ESCLUSO

Structure 100 + drawer + grate shelves
Washbasin not included

STRUTTURA IN METALLO VERNICIATO
STRUCTUR MADE IN PAINTED METAL

VISTA FRONTALE / FRONT VIEW

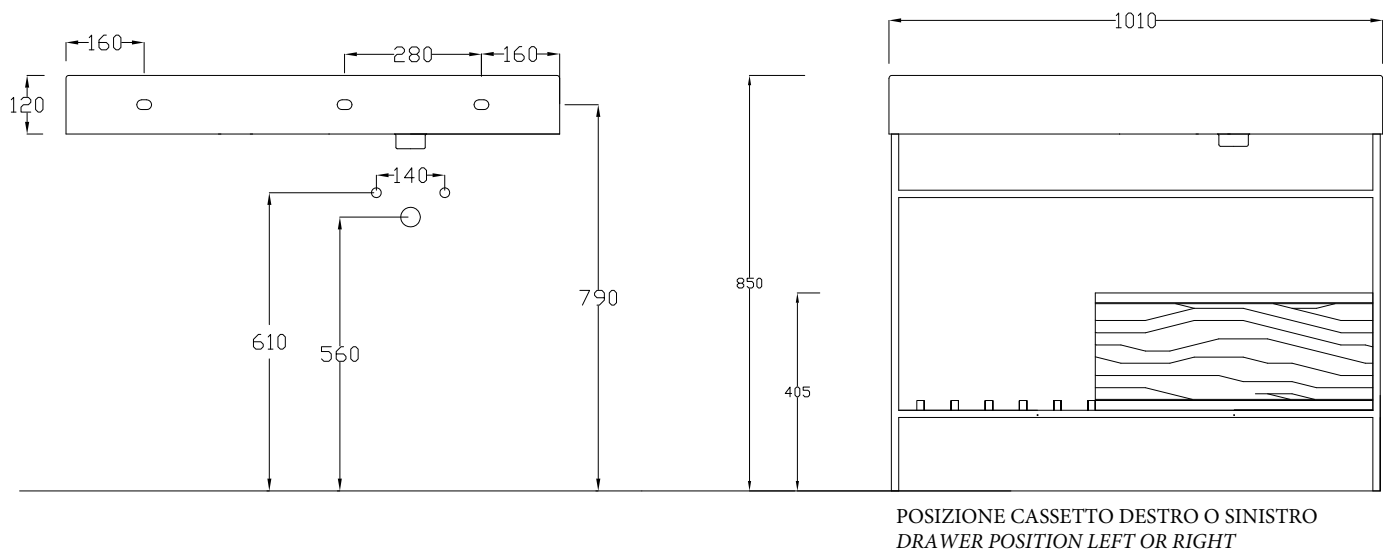

VISTA LATERALE / SIDE VIEW

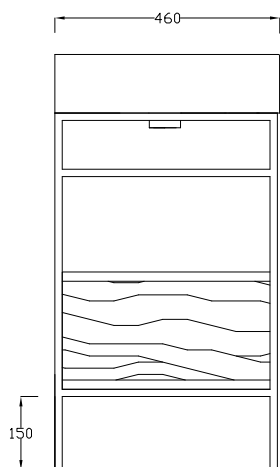

CASSETTO / DRAWER

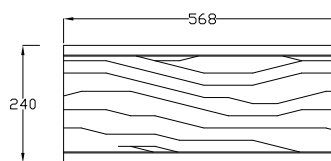

SISTEMA APERTURA PUSH PULL
PUSH PULL SYSTEM

GRIGLIA / SHELF

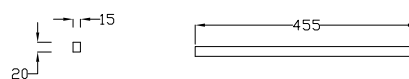

ATTENZIONE:
Le misure possono subire delle variazioni, dovute ad usura stampi e a variazioni delle caratteristiche delle materie prime che compongono l'impasto. Hidra si riserva il diritto di apportare in qualsiasi momento modifiche tecniche, costruttive e dimensionali utili al miglioramento della produzione. Consultare www.hidra.it per eventuali aggiornamenti.

ATTENTION:
Size could change for the usure of the moulds or for the changes of first material used in the mixture. Hidra reserves the right to make at any time technical, construction and dimensional changes, useful to improve production. Consult www.hidra.it for updates

STRUTTURA 100 - COMPOSIZIONE 1 cassetto + griglia
LAVABO ESCLUSO

Structure 100 + drawer + grate shelves
Washbasin not included

STRUTTURA IN METALLO VERNICIATO
STRUCTUR MADE IN PAINTED METAL

VISTA FRONTALE / FRONT VIEW

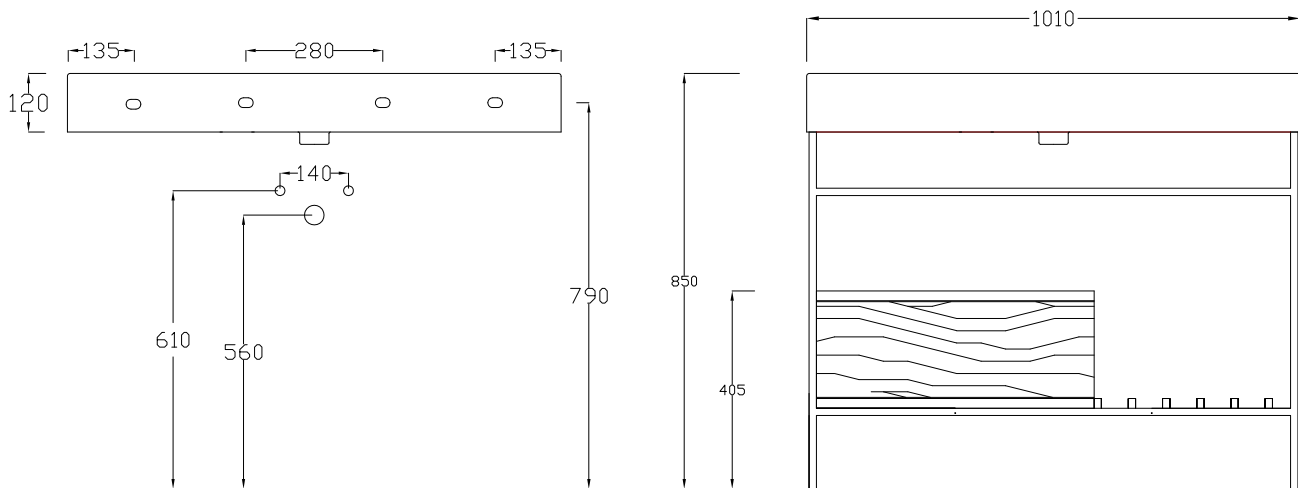

POSIZIONE CASSETTO DESTRO O SINISTRO
DRAWER POSITION LEFT OR RIGHT

VISTA LATERALE / SIDE VIEW

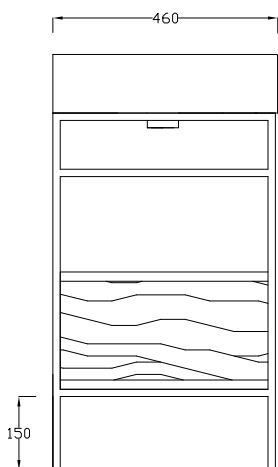

CASSETTO / DRAWER

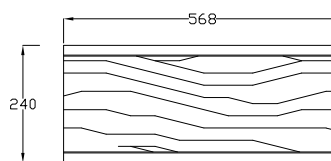

SISTEMA APERTURA PUSH PULL
PUSH PULL SYSTEM

GRIGLIA / SHELF

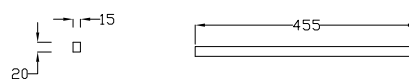

ATTENZIONE:
Le misure possono subire delle variazioni, dovute ad usura stampi e a variazioni delle caratteristiche delle materie prime che compongono l'impasto. Hidra si riserva il diritto di apportare in qualsiasi momento modifiche tecniche, costruttive e dimensionali utili al miglioramento della produzione. Consultare www.hidra.it per eventuali aggiornamenti.

ATTENTION:
Size could change for the usure of the moulds or for the changes of first material used in the mixture. Hidra reserves the right to make at any time technical, construction and dimensional changes, useful to improve production. Consult www.hidra.it for updates