



Pen Hill Estate, Park Spring Road, Barnsley S72 7EZ
Tel: 01226 446 000 Fax: 01226 711 185
Email: enquiries@symphony-group.co.uk
www.symphony-group.co.uk/aquadi

LINDO.

THE COLLECTION

2016

DESIGN & PRICE GUIDE

To ensure the continuous development and improvement of our products, we reserve the right to make changes to the colour, design and descriptions or methods of manufacture of our furniture. Such changes may be made without prior notice and without incurring liability. In many of our products we use wood, a natural living material which will reflect a variety of grains and textures and so variances must be allowed for. Styles that feature timber, PVC, laminates and melamine finishes may incur a slight colour change over the years. The term 'solid timber' applies to door and drawer fronts only. Colour reproduction in this brochure is as accurate as printing techniques will allow. Not every showroom contains all the products featured in this brochure. Aquadi is a registered trademark of The Symphony Group PLC. Copyright and all other rights in this brochure and the photographs and the works upon which it is based, are owned by The Symphony Group PLC. No part of this brochure and said photographs and other works may be reproduced or transmitted in any form or by any means (including but not limited to photocopying or storing in any electronic medium) without the prior express written permission of The Symphony Group PLC. Copyright © Symphony Group PLC 2016.



Made in the UK



When you have finished with this brochure please recycle it.



LINDO.

THE COLLECTION

A stunning on-trend collection of modular and fitted furniture.

Lindo. The Collection is a striking range of designer bathroom furniture. Inspired by the desire for minimalist uncluttered living, Lindo. The Collection combines modular and fitted furniture to transform your bathroom into a tranquil paradise.

All prices are effective from 1st January 2016.
All units are assembled. All prices include VAT.



Aquadi bathrooms is the first FIRA Gold Product certified bathroom furniture supplier. FIRA Gold provides you with total reassurance of the quality of your Aquadi furniture.



Made in the UK

We are proud to manufacture Aquadi furniture in our quality controlled, state-of-the-art facilities in Barnsley, South Yorkshire.



To demonstrate our confidence in the performance and quality of our bathroom furniture, we offer a 10 year guarantee.

Aquadi bathroom products are available from hundreds of national bathroom retailers and specialist bathroom showrooms throughout the UK.

A bathroom collection unlike any other.

Aquadi bathrooms are brought to you by Symphony, the UK's largest privately owned fitted furniture supplier. With over 45 years' experience, we source the finest materials and combine them with efficient design to meet the needs of contemporary lifestyles.



LINDO.

THE COLLECTION

LINDO LINEAR INLINE NAPLES

GETTING STARTED

How to use this guide	06
How to order	06

THE RANGES

The Lindo Collection	
Aviano and Marinella	12-13
Cambiano and Carrara	14-15
Castello and Larino	16-17
Fiora Anthracite and Fiora Ivory	18-19
Fiora Cashmere	20-21
Fiora White	22-23
Girona	24-25
Granada	26-27
San Marco Cashmere and San Marco White	28-29
Sizzano Dakar	30-31
Sizzano Grey and Sizzano White	32-33
Range Specifications and Pricing	34-53
The Linear Collection	
Linear Fiora Cashmere	56-57
Linear Sizzano White	58-59
Range Specifications and Pricing	60-67
The Inline Collection	
Inline Matt - Granada	70-71
Inline Gloss - Sizzano Grey	72-73
Range Specifications and Pricing	74-79

The Naples Collection

Naples Stone	82-83
Naples Clay	84-85
Range Specifications and Pricing	86-90

ACCESSORIES

Handles	92-93
Countertops	94-97

FINISHING TOUCHES

Taps	99
Accessories	99-100

TECHNICAL GUIDE

Planning Guide	102-103
Cabinet Specifications	
Lindo, Inline and Naples	104-105
Linear	106-107
Technical Information	108-111
Linear Base Units - Handle Trim Fitting	112
Linear Modular Units - Handle Trim Fitting	113

HOW TO USE THIS GUIDE

Lindo. The Collection offers four independent portfolios of bathroom furniture and a portfolio of common accessories. Browse through our range of products and select the one that suits your home best. Then select the units to create your bathroom paradise.

We recommend that you visit your local retailer for their expert planning and design advice and to view the products.

HOW TO ORDER

- 1 Select your portfolio: Lindo, Linear, Inline or Naples
- 2 Select the style/colour
- 3 Select your units and cabinet colour
Remember to state handing of your units (if applicable)
- 4 Choose your handles
- 5 Decide on your countertop
- 6 Pick your accessories

Now you have an idea of what you want, simply contact your local retailer to design your dream bathroom.

We hope you enjoy creating the perfect bathroom with us.

LINDO



INLINE



LINEAR



NAPLES



RANGE OVERVIEW

INLINE RANGE COLOURS

The Inline handle takes the form of a wave to create a contemporary finish, generating a “wow” factor within your bathroom.

INLINE GLOSS



INLINE MATT

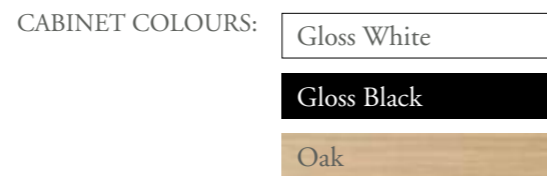

LINEAR RANGE COLOURS

Linear is a stunning design that creates a handleless finish perfect for today's modern bathrooms.



NAPLES RANGE COLOURS

Make a statement within your home with our traditional range of painted in-frame furniture.

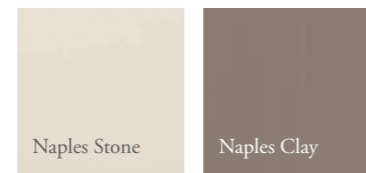

LINDO RANGE COLOURS

With 18 beautiful finishes combined with an abundance of units and finishing touches, The Lindo Collection is a bathroom designer's dream with its unique seamless bathroom style.

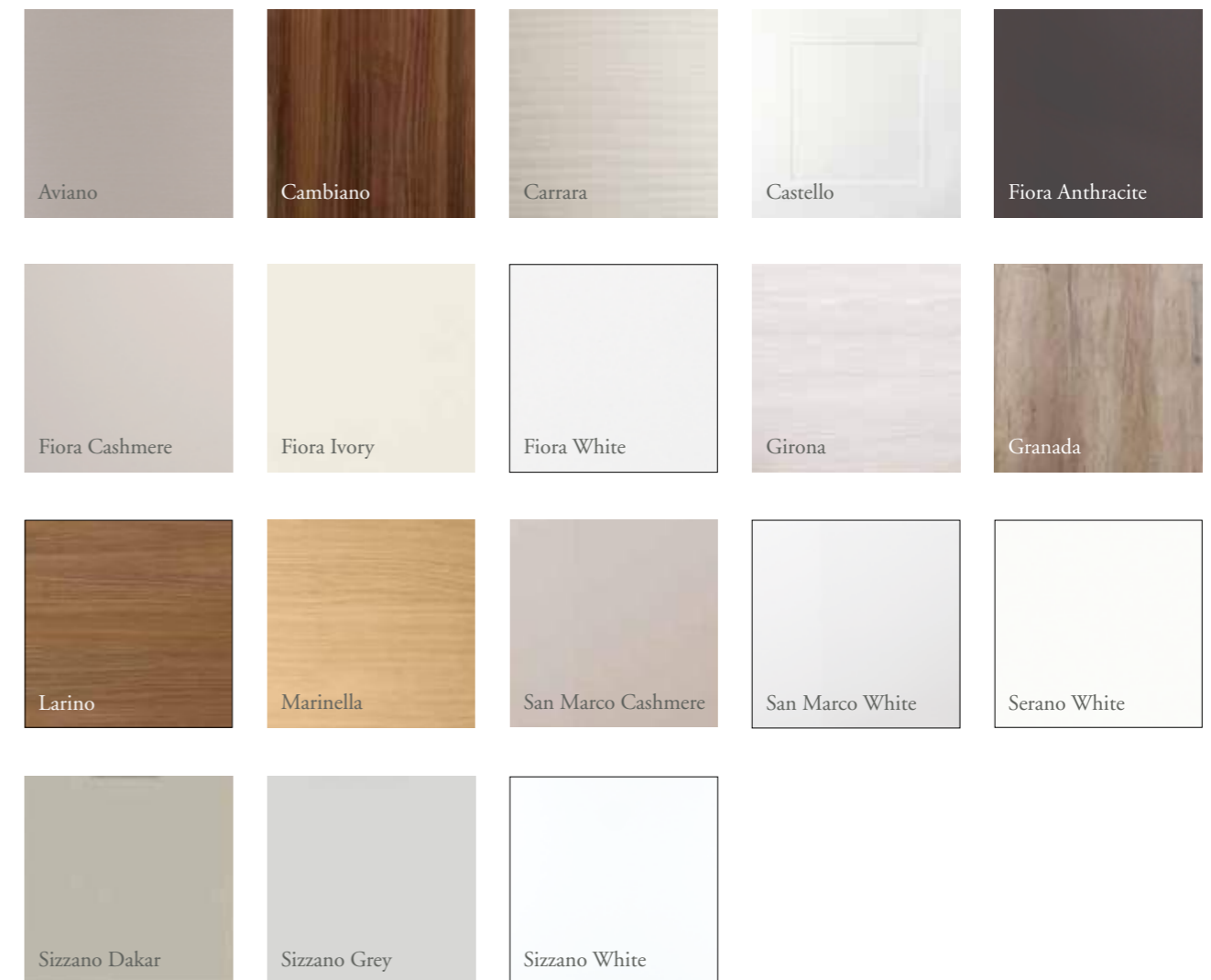



INTRODUCING LINDO

The Lindo Collection is a stunning range of designer bathroom furniture.

You can combine modular and fitted furniture units to create the perfect modern bathroom with all the storage space that you desire.



AVIANO AND MARINELLA



Aviano features an on-trend grained stone finish, whilst Marinella showcases a sophisticated oak door. Aviano is shown here on modular vanity units in combination with Marinella wc and tall units.

Handles shown: Chrome twist handle CHOICE75 (page 12/left page 13)
Chrome square curved 'D' bar handle CHOICE63 (top page 13)

Countertop shown: Gloss White laminate



CAMBIANO AND CARRARA



This stunning gloss walnut door of Cambiano creates the perfect designer finish, set in our gloss black cabinet. Carrara, with its white and grey woodgrain tones, sets it apart as the luxury bathroom range.

Handles shown: Chrome angled 'C' handle CHOICE62 (page 14)
Chrome glitter bar handle CHOICE72 (left page 15)
Bright chrome arrow handle CHOICE76 (bottom page 15)

Countertops shown: Carbon Odyssey solid surface (page 14)
Strass Noir laminate (page 15)





CASTELLO AND LARINO



Castello has a striking gloss white shaker style, used here in combination with traditional mirrors and shelves.

Larino is a sensational walnut door featuring a striking horizontal woodgrain.

Handles shown: Chrome bow handle
CHOICE64 (page 16)

Chrome chunky square 'C' knob
CHOICE61 (page 17)

Countertops shown: Designer White solid surface (page 16)

Strass Noir laminate (page 17)



FIORA ANTHRACITE AND FIORA IVORY



The gloss anthracite Fiora finish offers a stylish setting for an ultra-modern bathroom, whilst the high gloss ivory finish is a refreshing alternative to the ever-popular finish of gloss white.

Handles shown: Open bright chrome handle CHOICE80 (page 18)
Rippled chrome handle CHOICE79 (page 19)



FIORA CASHMERE



Fiora Cashmere has an encapsulating gloss finish which creates the perfect subtle yet luxurious tone for a modern bathroom.

Basin shown: 1200mm Softform one piece basin and countertop

Handle shown: Chrome chunky square 'D' bar handle CHOICE60





FIORA WHITE



The popular finish of gloss white is shown on the left with two modular curved end units to make a real statement within your home.

Handle shown: Chrome and Crystalized™ Swarovski Elements pull handle LUXURY01

Countertops shown: Gloss White laminate (page 22, top page 23)
Marble Noir laminate (right page 23)



LINDO/LINEAR/INLINE/NAPLES



GIRONA

The cross-grained, textured finish of Girona sets it apart as an on-trend and luxury option to help create your perfect bathroom paradise.

Handle shown: Chrome twist handle
CHOICE75

Countertop shown: Carbon Odyssey solid surface





GRANADA



The striking dark oak and vertical grain finish of Granada is both stylish and on-trend. The resulting finish gives a warm and homely feel, perfect for a contemporary family bathroom.

Handle shown: Chrome chunky square 'C' knob CHOICE61

Countertop shown: Designer White solid surface



SAN MARCO CASHMERE AND SAN MARCO WHITE



The clean, straight lines that define San Marco are shown here in a stunning gloss white and a gorgeous shade of cashmere. The integrated handle is what sets it apart to offer an ultra-modern living space.

Handle shown: Luxury integrated handle

Countertops shown: Atlanta Marble laminate (page 28)

Strass Noir laminate (top page 29)



SIZZANO DAKAR



The high gloss finish of Sizzano Dakar is set apart from the rest by its glass effect edging, making this the perfect modern and sleek option for your bathroom.

The modular wall hung basin unit features the latest push-to-open drawer technology.

Featured: Spinning mirror unit

Countertop shown: Designer White solid surface





SIZZANO GREY AND SIZZANO WHITE



Sizzano is enhanced by its duo edging, presenting a shimmering glass effect finish. The Sizzano Grey cloakroom basin unit and reduced depth WC unit maximise the use of space, while Sizzano White contrasts effortlessly with the darker Fiora Anthracite tall storage units.

Handles shown: Rippled chrome handle CHOICE79 (page 32)
Large chrome bar handle CHOICE57 (page 33)

Countertops shown: Designer White solid surface (page 32)
Atlanta Marble laminate (page 33)

FURNITURE PRICE GUIDE - LINDO

All units are supplied assembled and are available in a wide range of sizes to fit any bathroom.
Reduced depth units are also available for those smaller bathrooms and cloakrooms.

HOW TO ORDER

- 1 Select your preferred range
- 2 Select your preferred style (Freestanding/Fitted/Modular)
- 3 Select your units and cabinet colour
Remember to state handing of your units (if applicable)
- 4 Choose your handles
- 5 Decide on your countertop
- 6 Pick your accessories

MODULAR VS FITTED



All The Lindo Collection and Linear finishes are available with either fitted or wall-hung modular options.
Take a look at the units over the following pages to see the range content.

RANGE SPECIFICATIONS - LINDO

LINDO - PRICE BAND 0

RANGE	AVIANO	GIRONA	GRANADA
DESCRIPTION	Matt Stone PVC-edged grained MFC	Light Ash PVC-edged cross-grained MFC	Dark Oak PVC-edged textured MFC
STD CABINET	Gloss White	Gloss White	Gloss Black
STD HANDLE	CHOICE75	CHOICE79	CHOICE76

LINDO - PRICE BAND 1

RANGE	FIORA ANTHRACITE	FIORA CASHMERE
DESCRIPTION	Gloss Anthracite Painted MFC	Gloss Cashmere Painted MFC
STD CABINET	Gloss Black	Gloss White
STD HANDLE	CHOICE81	CHOICE81

LINDO - PRICE BAND 1

RANGE	FIORA IVORY	FIORA WHITE	LARINO	MARINELLA	SERANO WHITE	SIZZANO WHITE
DESCRIPTION	Gloss Ivory Painted MFC	Gloss White Painted MFC	Walnut PVC Wrapped Flat MDF Panel	Oak PVC Wrapped Flat MDF Panel	Gloss White PVC Wrapped Flat MDF Panel	Gloss White Painted MDF with glass effect edging
STD CABINET	Gloss White	Gloss White	Gloss Black	Oak	Gloss White	Gloss White
STD HANDLE	CHOICE81	CHOICE81	CHOICE61	CHOICE63	CHOICE66	CHOICE65

LINDO - PRICE BAND 1

RANGE	SIZZANO DAKAR	SIZZANO GREY
DESCRIPTION	Gloss Dakar Acrylic with glass effect edging	Gloss Grey Acrylic with glass effect edging
STD CABINET	Gloss White	Gloss White
STD HANDLE	CHOICE79	CHOICE79

LINDO - PRICE BAND 2

RANGE	CAMBIANO	CARRARA	CASTELLO
DESCRIPTION	Gloss Walnut PVC Wrapped Flat MDF Panel with metallic back	Gloss White Grey Woodgrain PVC Wrapped Flat MDF with white back	Gloss White PVC Wrapped MDF Shaker
STD CABINET	Gloss Black	Gloss White	Gloss White
STD HANDLE	CHOICE62	CHOICE76	CHOICE64

LINDO - PRICE BAND 2

RANGE	SAN MARCO WHITE	SAN MARCO CASHMERE
DESCRIPTION	Gloss White Painted MDF with integrated handle	Gloss Cashmere Painted MDF with integrated handle
STD CABINET	Gloss White	Gloss White
STD HANDLE	N/A	N/A

CABINET COLOURS

	GLOSS WHITE Laser-edged MFC
	GLOSS BLACK Laser-edged MFC
	OAK Laser-edged MFC

REPLACEMENT END PANELS

To enhance the finish of a selection of our bathrooms within the Lindo Collection, replacement cabinet end panels are available to order at no extra cost if ordered with a unit.

The replacement end panels are designed to be used at the exposed ends of a unit run only.

On base and tall storage units, the replacement cabinet end panel is a full length panel extending to the floor and therefore additional end blender panels will not be required.

Replacement cabinet ends are easy to order, simply add on one of the following suffixes to the standard unit code:

- For a replacement cabinet end to the **left** hand side of a unit add **GL** - for example BC338**GL**
- For a replacement cabinet end to the **right** hand side of a unit add **GR** - for example BC338**GR**
- For replacement cabinet ends to **both left** and **right** sides of a unit add **G2** - for example BC338**G2**

Range	Door Colour	Replacement End External Colour	Replacement End Internal Colour	Replacement End Grain Direction
Aviano	Matt Stone	Matt Stone	Matt Stone	Vertical
Cambiano	Gloss Walnut	Gloss Walnut	Metallic	Vertical
Carrara	Gloss White/Grey	Gloss White/Grey	Matt White	Horizontal
Fiora Anthracite	Gloss Anthracite	Gloss Anthracite	Matt Anthracite	N/A
Fiora Cashmere	Gloss Cashmere	Gloss Cashmere	Matt Cashmere	N/A
Fiora Ivory	Gloss Ivory	Gloss Ivory	Matt Ivory	N/A
Girona	Matt Light Ash	Matt Light Ash	Matt Light Ash	Horizontal
Granada	Matt Dark Oak	Matt Dark Oak	Matt Dark Oak	Vertical
Larino	Matt Walnut	Matt Walnut	Matt Walnut	Vertical
San Marco Cashmere	Gloss Cashmere	Gloss Cashmere	Matt Cashmere	N/A
Sizzano Dakar	Gloss Dakar	Gloss Dakar	Matt Dakar	N/A
Sizzano Grey	Gloss Grey	Gloss Grey	Matt Grey	N/A

LINDO/LINEAR/INLINE/NAPLES

FREESTANDING UNITS▲

There are a number of freestanding units available to make it easier than ever to create your perfect bathroom. These items as detailed below include the unit and corresponding basin (if applicable) and plinth.



Inline Sit-on Basin
Requires 600W cabinet
No worktop required
1 tap hole, reversible
Requires slotted waste (not included).
Material: Marblecast.
600W x 50H x 365D



Inline Sit-on Basin
Requires 800W cabinet
No worktop required
1 tap hole, reversible
Requires slotted waste (not included).
Material: Marblecast.
800W x 50H x 365D



Cloakroom Basin
Suitable only for cloakroom units
Requires slotted waste (not included).
Material: Marblecast.
400W x 45H x 220D



1200mm Softform One Piece Basin and Countertop
Requires slotted waste (not included)
Please specify the handing when ordering
Material: Marblecast.
1205W x 145H x 455D
Not recommended for San Marco



BASIN UNIT WITH BASIN

INCLUDES IN-LINE BASIN, 2 DOORS, 1 SHELF, PLINTH. NO WORKTOP REQUIRED. REQUIRES SLOTTED WASTE (NOT INCLUDED)

		Price Band 0	Price Band 1	Price Band 2
600W x 350D x 811H (861H inc. basin)	BC638BASFS	£403	£424	£475
800W x 350D x 811H (861H inc. basin)	BC838BASFS	£466	£488	£543

1200MM RUN WITH SOFTFORM BASIN†*

INCLUDES 600MM SEMI-RECESSED BASIN UNIT (SRBC638), 600MM WC UNIT WITH CISTERN (WCCPB638) AND ONE PIECE BASIN AND COUNTERTOP. REQUIRES SLOTTED WASTE (NOT INCLUDED). INCLUDES 2400MM PLINTH

		Price Band 0	Price Band 1	Price Band 2
Left hand basin: 1200W x 350D x 811H (455D/823H inc. basin)	BAS12CPKL	£916	£969	£1,033
Right hand basin: 1200W x 350D x 811H (455D/823H inc. basin)	BAS12CPKR	£916	£969	£1,033

WC UNIT WITH CISTERN†**

1 FIXED PANEL, 1 REMOVABLE PANEL, INCLUDES PLINTH, WITH DUAL FLUSH CONCEALED CISTERN. PLEASE ORDER WITH COUNTERTOP CT6036

		Price Band 0	Price Band 1	Price Band 2
600W x 350D x 811H	WCCPB638FS	£354	£376	£406

WC UNIT COUNTERTOP

TO FIT ON WC UNIT WCCPB638FS. AVAILABLE FINISHES ON PAGE 94

		Price Band 0	Price Band 1	Price Band 2
605W x 360D x 28H	CT6036	£70	£70	£70

CLOAKROOM MODULAR WALL HUNG UNIT WITH BASIN

INCLUDES CLOAKROOM BASIN, 1 DOOR, 1 SHELF. NO WORKTOP OR PLINTH REQUIRED. REQUIRES SLOTTED WASTE (NOT INCLUDED)

		Price Band 0	Price Band 1	Price Band 2
400W x 220D x 561H (606H inc. basin)	MODCR456BAS	£354	£374	£393

CLOAKROOM FLOORSTANDING UNIT WITH BASIN

INCLUDES CLOAKROOM BASIN, 1 DOOR, 1 SHELF, PLINTH. NO WORKTOP REQUIRED. REQUIRES SLOTTED WASTE (NOT INCLUDED)

		Price Band 0	Price Band 1	Price Band 2
400W x 220D x 811H (856H inc. basin)	BCR428FS	£360	£380	£390

▲Standard handle is included in the price of doored/drawer units. †Cistern is supplied loose. **WC units are designed for the cistern to be front access only through the top fascia panel. Therefore alternative cisterns need to be front access and the push button/flush needs to have a flexible cistern connection to allow the panel to be removed. *Please order with countertop CT6036 and state your desired finish - see pages 94-95.

FITTED UNITS Sanitaryware Packs*

Please see a selection of stunning basins and WCs that are designed to complement our range of furniture.

Aquadi by Symphony is proud to be working in partnership with Vitra to offer our customers the perfect furniture and sanitaryware combination to ensure you are pleased with your bathroom for many years to come.



VittrA S20

This contemporary product range provides excellent value and high durability. S20 is easy to fit and offers an efficiently stylish solution for your bathroom needs.



S20 Back To Wall WC
Includes soft close seat
360W x 400H x 540D



S20 Wall Hung WC
Includes soft close seat
Requires Wall Hung Frame
360W x 350H x 520D



Wall Hung Frame
For Wall Hung WC
(not a Vitra product)
345W x 450H x 47D



S20 Reduced Depth Basin
1 tap hole
Requires slotted waste (not included)
450W x 165H x 355D



S20 Standard Depth Basin
1 tap hole
Requires slotted waste (not included)
550W x 170H x 440D

*Plinth not included with units. For plinth see page 53. Standard handle is included in the price of doored/drawer units.

		Price Band 0	Price Band 1	Price Band 2
	REDUCED DEPTH WC UNIT WITH CISTERN AND S20 BACK TO WALL WC†*	1 FIXED PANEL, 1 REMOVABLE PANEL, INCLUDES S20 WC, WITH DUAL FLUSH CONCEALED CISTERN		
	500W x 220D x 811H 600W x 220D x 811H	WC52BPS20 WC62BPS20	£533 £533	£556 £556
	STANDARD DEPTH WC UNIT WITH CISTERN AND S20 BACK TO WALL WC†*	1 FIXED PANEL, 1 REMOVABLE PANEL, INCLUDES S20 WC, WITH DUAL FLUSH CONCEALED CISTERN		
	500W x 350D x 811H 600W x 350D x 811H	WC53BPS20 WC63BPS20	£533 £533	£556 £556
	REDUCED DEPTH WC UNIT WITH CISTERN AND S20 WALL HUNG WC†*	1 FIXED PANEL, 1 REMOVABLE PANEL, INCLUDES S20 WALL HUNG WC, WALL HUNG FRAME WITH DUAL FLUSH CONCEALED CISTERN		
	500W x 220D x 811H 600W x 220D x 811H	WC52WPS20 WC62WPS20	£794 £794	£817 £817
	STANDARD DEPTH WC UNIT WITH CISTERN AND S20 WALL HUNG WC†*	1 FIXED PANEL, 1 REMOVABLE PANEL, INCLUDES S20 WALL HUNG WC, WALL HUNG FRAME WITH DUAL FLUSH CONCEALED CISTERN		
	500W x 350D x 811H 600W x 350D x 811H	WC53WPS20 WC63WPS20	£794 £794	£817 £817
	REDUCED DEPTH SEMI-RECESSED BASIN UNIT WITH S20 REDUCED DEPTH BASIN	1 FIXED PANEL, 2 DOORS, INCLUDES S20 REDUCED DEPTH BASIN		
	500W x 220D x 811H 600W x 220D x 811H	SRBC52S20 SRBC62S20	£366 £366	£396 £396
	STANDARD DEPTH SEMI-RECESSED BASIN UNIT WITH S20 STANDARD DEPTH BASIN	1 FIXED PANEL, 2 DOORS, 1 SHELF, INCLUDES S20 STANDARD DEPTH BASIN		
	600W x 350D x 811H 800W x 350D x 811H	SRBC63S20 SRBC83S20	£366 £433	£396 £471

WC units excluding the cistern and push button are also available. Simply replace the 'P' with an 'A' in the product code, e.g. WC52BAS20.

*WC units are designed for the cistern to be front access only through the top fascia panel. Therefore the cistern needs to be front access and the push button/flush needs to have a flexible cistern connection to allow the panel to be removed.

Sanitaryware Packs

VitrA S50

Versatility is a defining feature of S50. Choose either contemporary square lines or organically rounded basins in a choice of sizes. The end result is a suite that meets the users needs for perfection.



S50 Back To Wall WC
Includes soft close seat
355W x 400H x 540D



S50 Reduced Depth Square Basin
1 tap hole, Right Hand
Requires slotted waste (not included)
550W x 170H x 370D



S50 Standard Depth Square Basin
1 tap hole
Requires slotted waste (not included)
550W x 205H x 470D



S50 Reduced Depth Round Basin
1 tap hole, Right Hand
Requires slotted waste (not included)
550W x 170H x 360D



S50 Standard Depth Round Basin
1 tap hole
Requires slotted waste (not included)
550W x 185H x 450D

Price	Price	Price
Band 0	Band 1	Band 2

Price	Price	Price
Band 0	Band 1	Band 2

REDUCED DEPTH WC UNIT WITH CISTERN AND S50 BACK TO WALL WC†*

1 FIXED PANEL, 1 REMOVABLE PANEL, INCLUDES S50 WC, WITH DUAL FLUSH CONCEALED CISTERN

500W x 220D x 811H	WC52BPS50	£591	£614	£644
600W x 220D x 811H	WC62BPS50	£591	£614	£644

STANDARD DEPTH WC UNIT WITH CISTERN AND S50 BACK TO WALL WC†*

1 FIXED PANEL, 1 REMOVABLE PANEL, INCLUDES S50 WC, WITH DUAL FLUSH CONCEALED CISTERN

500W x 350D x 811H	WC53BPS50	£591	£614	£644
600W x 350D x 811H	WC63BPS50	£591	£614	£644

REDUCED DEPTH SEMI-RECESSED BASIN UNIT WITH S50 REDUCED DEPTH SQUARE BASIN

1 FIXED PANEL, 2 DOORS, INCLUDES S50 REDUCED DEPTH SQUARE BASIN

600W x 220D x 811H	SRBC62SS50	£380	£410	£444
--------------------	------------	------	------	------

STANDARD DEPTH SEMI-RECESSED BASIN UNIT WITH S50 STANDARD DEPTH SQUARE BASIN

1 FIXED PANEL, 2 DOORS, 1 SHELF, INCLUDES S50 STANDARD DEPTH SQUARE BASIN

600W x 350D x 811H	SRBC63SS50	£380	£410	£444
800W x 350D x 811H	SRBC83SS50	£447	£485	£527

REDUCED DEPTH SEMI-RECESSED BASIN UNIT WITH S50 REDUCED DEPTH ROUND BASIN

1 FIXED PANEL, 2 DOORS, INCLUDES S50 REDUCED DEPTH ROUND BASIN

600W x 220D x 811H	SRBC62RS50	£380	£410	£444
--------------------	------------	------	------	------

STANDARD DEPTH SEMI-RECESSED BASIN UNIT WITH S50 STANDARD DEPTH ROUND BASIN

1 FIXED PANEL, 2 DOORS, 1 SHELF, INCLUDES S50 STANDARD DEPTH ROUND BASIN

600W x 350D x 811H	SRBC63RS50	£380	£410	£444
800W x 350D x 811H	SRBC83RS50	£447	£485	£527

WC units excluding the cistern and push button are also available. Simply replace the 'P' with an 'A' in the product code, e.g. WC52BAS50.

†Cistern is supplied loose.

*WC units are designed for the cistern to be front access only through the top fascia panel. Therefore the cistern needs to be front access and the push button/flush needs to have a flexible cistern connection to allow the panel to be removed.

Inline Basins

The marblecast design of the inline sit-on basins are perfectly designed to suit our 600mm and 800mm standard depth basin units.



Inline Sit-on Basin
Requires 600W cabinet
No worktop required
1 tap hole, reversible
Requires slotted waste (not included)
Material: Marblecast
600W x 50H x 365D



Inline Sit-on Basin
Requires 800W cabinet
No worktop required
1 tap hole, reversible
Requires slotted waste (not included)
Material: Marblecast
800W x 50H x 365D

Price	Price	Price
Band 0	Band 1	Band 2

STANDARD DEPTH SEMI-RECESSED BASIN UNIT WITH INLINE BASIN

1 FIXED PANEL, 2 DOORS, 1 SHELF, INCLUDES INLINE BASIN

600W x 350D x 811H	SRBC63INB	£478	£508	£542
800W x 350D x 811H	SRBC83INB	£592	£630	£672

*Plinth not included with units. For plinth see page 53. Standard handle is included in the price of doored/drawer units.

*Plinth not included with units. For plinth see page 53. Standard handle is included in the price of doored/drawer units.

REDUCED DEPTH BASE UNITS*

Price Band 0 Price Band 1 Price Band 2

BASE OPEN SHELF		1 SHELF		
150W x 200D x 811H	BGLOS1528	£108	£108	£108
300W x 200D x 811H	BGLOS328	£122	£122	£122
400W x 200D x 811H	BGLOS428	£128	£128	£128
450W x 200D x 811H	BGLOS4528	£132	£132	£132
BASE OPEN SHELF		1 SHELF		
500W x 200D x 811H	BGLOS528	£135	£135	£135
600W x 200D x 811H	BGLOS628	£142	£142	£142
800W x 200D x 811H	BGLOS828	£152	£152	£152
BASE UNIT		1 DOOR, 1 SHELF		
150W x 220D x 811H	BC1528	£145	£161	£165
300W x 220D x 811H	BC328	£164	£182	£192
400W x 220D x 811H	BC428	£172	£191	£201
450W x 220D x 811H	BC4528	£177	£196	£206
BASE UNIT		2 DOORS, 1 SHELF		
500W x 220D x 811H	BC528	£181	£201	£231
600W x 220D x 811H	BC628	£185	£205	£256
800W x 220D x 811H	BC828	£198	£220	£276
WC UNIT*		1 FIXED PANEL, 1 REMOVABLE PANEL		
500W x 220D x 811H	WCC528	£206	£229	£259
600W x 220D x 811H	WCC628	£206	£229	£259
WC UNIT WITH CISTERN†*		1 FIXED PANEL, 1 REMOVABLE PANEL, WITH DUAL FLUSH CONCEALED CISTERN		
500W x 220D x 811H	WCCPB528	£343	£365	£395
600W x 220D x 811H	WCCPB628	£343	£365	£395
SEMI-RECESSED BASIN UNIT		1 FIXED PANEL, 2 DOORS, 1 SHELF		
500W x 220D x 811H	SRBC528	£271	£301	£335
600W x 220D x 811H	SRBC628	£271	£301	£335

*Plinth not included with units. For plinth see page 53. Standard handle is included in the price of doored/drawer units. †Cistern is supplied loose.
*WC units are designed for the cistern to be front access only through the top fascia panel. Therefore the cistern needs to be front access and the push button/flush needs to have a flexible cistern connection to allow the panel to be removed.









STANDARD BASE UNITS*

Price Band 0 Price Band 1 Price Band 2

BASE OPEN SHELF		1 SHELF		
150W x 330D x 811H	BGLOS1538	£108	£108	£108
300W x 330D x 811H	BGLOS338	£122	£122	£122
400W x 330D x 811H	BGLOS438	£128	£128	£128
450W x 330D x 811H	BGLOS4538	£132	£132	£132
BASE OPEN SHELF		1 SHELF		
500W x 330D x 811H	BGLOS538	£135	£135	£135
600W x 330D x 811H	BGLOS638	£142	£142	£142
800W x 330D x 811H	BGLOS838	£152	£152	£152
BASE CORNER OPEN SHELF		1 SHELF, 1 BLANK PANEL		
600W x 330**D x 811H **350mm(D) including blank panel Can be handed either left or right Corner post included When ordering, please state which side the blanking panel is to be (either left or right)	CBGLOS638	£173	£173	£173
BASE UNIT		1 DOOR, 1 SHELF		
150W x 350D x 811H	BC1538	£145	£161	£165
300W x 350D x 811H	BC338	£164	£182	£192
400W x 350D x 811H	BC438	£172	£191	£201
450W x 350D x 811H	BC4538	£177	£196	£206
BASE UNIT WITH INTERNAL DRAWERS		1 DOOR, 3 INTERNAL DRAWERS		
300W x 350D x 811H	BC338ID	£410	£455	£479
400W x 350D x 811H	BC438ID	£430	£478	£503
BASE UNIT		2 DOORS, 1 SHELF		
500W x 350D x 811H	BC538	£181	£201	£231
600W x 350D x 811H	BC638	£185	£205	£256
800W x 350D x 811H	BC838	£198	£220	£276
CURVED END UNIT		1 DOOR, 1 SHELF. AVAILABLE IN FIORA WHITE ONLY. INCLUDES 300MM CURVED PLINTH		
300W x 350D x 811H	BC338CU	N/A	£564	N/A
BASE CORNER UNIT		1 DOOR, 1 SHELF		
600W x 350D x 811H 300W door. Corner post included Can be handed either left or right When ordering, please state which side the blanking panel is to be (either left or right)	CBC638	£214	£238	£242

*Plinth not included with units. For plinth see page 53. Standard handle is included in the price of doored/drawer units.

STANDARD BASE UNITS*

		Price Band 0	Price Band 1	Price Band 2	
	BASE UNIT WITH DRAWER	1 DOOR, 1 DRAWER, 1 SHELF			
	300W x 350D x 811H	BCTD338	£218	£242	£248
	400W x 350D x 811H	BCTD438	£246	£273	£288
	450W x 350D x 811H	BCTD4538	£258	£287	£302
	BASE UNIT WITH DRAWER	2 DOORS, 1 DRAWER, 1 SHELF			
	500W x 350D x 811H	BCTD538	£271	£301	£327
	600W x 350D x 811H	BCTD638	£277	£307	£384
	800W x 350D x 811H	BCTD838	£297	£330	£413
	TWO DRAWER BASE UNIT	SOFT CLOSE, FULL EXTENSION			
	400W x 350D x 811H	2DP438	£397	£431	£449
	500W x 350D x 811H	2DP538	£417	£453	£471
	TWO DRAWER BASE UNIT WITH INTERNAL DRAWER	SOFT CLOSE, FULL EXTENSION, 1 INTERNAL DRAWER			
	400W x 350D x 811H	2DP438ID	£474	£515	£536
	500W x 350D x 811H	2DP538ID	£494	£537	£559
	WC UNIT*	1 FIXED PANEL, 1 REMOVABLE PANEL			
	500W x 350D x 811H	WCC538	£206	£229	£259
	600W x 350D x 811H	WCC638	£206	£229	£259
	WC UNIT WITH CISTERN†*	1 FIXED PANEL, 1 REMOVABLE PANEL, WITH DUAL FLUSH CONCEALED CISTERN			
	500W x 350D x 811H	WCCPB538	£343	£365	£395
	600W x 350D x 811H	WCCPB638	£343	£365	£395
	SEMI-RECESSED BASIN UNIT	1 FIXED PANEL, 2 DOORS, 1 SHELF			
	500W x 350D x 811H	SRBC538	£257	£286	£318
	600W x 350D x 811H	SRBC638	£271	£301	£335
	800W x 350D x 811H	SRBC838	£338	£376	£418
	DEEP VANITY BASIN UNIT	2 DOORS, 1 SHELF			
	600W x 550D x 811H	DVBC658	£241	£267	£295

*Plinth not included with units. For plinth see page 53. Standard handle is included in the price of doored/drawer units. †Cistern is supplied loose.
*WC units are designed for the cistern to be front access only through the top fascia panel. Therefore the cistern needs to be front access and the push button/flush needs to have a flexible cistern connection to allow the panel to be removed.

MODULAR WALL HUNG BASIN UNITS

Use this section to view the large range of modular wall hung units we have to offer. Vanity unit modules include a matching basin making it as easy as possible to create your perfect bathroom.

Slimline Basin Vanity Modules (includes basin and cabinet)



Slimline Sit-on Basin
No worktop required
Requires slotted waste (not included)
Not compatible with 280mm single drawer or units with internal drawers
Material: Marblecast
600W x 16H x 475D
800W x 16H x 475D

			Price Band 0	Price Band 1	Price Band 2
	SINGLE DRAWER MODULE*	BASIN DRAWER, INCLUDES SLIMLINE BASIN. NO WORKTOP REQUIRED. REQUIRES SLOTTED WASTE (NOT INCLUDED)			
	600W x 465D x 296H	MDW628SB	£534	£567	£590
	800W x 465D x 296H	MDW828SB	£604	£643	£669
	DEEP DRAWER MODULE*	BASIN DRAWER, INCLUDES SLIMLINE BASIN. NO WORKTOP REQUIRED. REQUIRES SLOTTED WASTE (NOT INCLUDED)			
	600W x 465D x 378H	MDW636SB	£567	£604	£630
	800W x 465D x 378H	MDW836SB	£643	£685	£715
	2 DRAWER MODULE*	BASIN DRAWERS, INCLUDES SLIMLINE BASIN. NO WORKTOP REQUIRED. REQUIRES SLOTTED WASTE (NOT INCLUDED)			
	600W x 465D x 577H	M2DW656SB	£613	£655	£742
	800W x 465D x 577H	M2DW856SB	£693	£742	£869
	DOUBLE DOOR MODULE	2 DOORS, 1 SHELF, INCLUDES SLIMLINE BASIN. NO WORKTOP REQUIRED. REQUIRES SLOTTED WASTE (NOT INCLUDED)			
	600W x 465D x 577H	M2DR656SB	£497	£527	£555





*Please note that these units are also available as a Touch Concept option at no additional cost. Simply add 'SC' after the number and before 'SB' in the product code, e.g. MDW628SCSB. No handles are required for the Touch Concept option.

All **single drawer basin modules** have a U-shaped cut out to accommodate for plumbing. All **deep drawer basin modules** have a scooped back to accommodate for plumbing. On the **2 drawer basin modules**, the top drawer has a U-shaped cut out, whilst the bottom drawer has a scooped back to accommodate for plumbing. Standard handle is included in the price of doored/drawer units. Height dimension includes basin where applicable.

Marblecast Basin Vanity Modules (includes basin and cabinet)







Marblecast Basin
No worktop required
Requires slotted waste (not included)
Material: Marblecast
502W x 110H x 470D
602W x 110H x 470D

		Price Band 0	Price Band 1	Price Band 2
	SINGLE DRAWER MODULE* BASIN DRAWER, INCLUDES MARBLECAST BASIN. NO WORKTOP REQUIRED. REQUIRES SLOTTED WASTE (NOT INCLUDED)			
	500W x 465D x 390H	MDW528MB	£538	£568
	600W x 465D x 390H	MDW628MB	£567	£600
	DEEP DRAWER MODULE* BASIN DRAWER, INCLUDES MARBLECAST BASIN. NO WORKTOP REQUIRED. REQUIRES SLOTTED WASTE (NOT INCLUDED)			
	500W x 465D x 472H	MDW536MB	£568	£602
	600W x 465D x 472H	MDW636MB	£600	£637
	DEEP DRAWER MODULE WITH INTERNAL DRAWER BASIN DRAWER, INCLUDES MARBLECAST BASIN. NO WORKTOP REQUIRED. REQUIRES SLOTTED WASTE (NOT INCLUDED)			
	500W x 465D x 472H	MDW536IDMB	£644	£686
	600W x 465D x 472H	MDW636IDMB	£684	£731
	2 DRAWER MODULE* BASIN DRAWERS, INCLUDES MARBLECAST BASIN. NO WORKTOP REQUIRED. REQUIRES SLOTTED WASTE (NOT INCLUDED)			
	500W x 465D x 671H	M2DW556MB	£623	£663
	600W x 465D x 671H	M2DW656MB	£646	£688
	DOUBLE DOOR MODULE 2 DOORS, 1 SHELF, INCLUDES MARBLECAST BASIN. NO WORKTOP REQUIRED. REQUIRES SLOTTED WASTE (NOT INCLUDED)			
	600W x 465D x 671H	M2DR656MB	£530	£560

*Please note that these units are also available as a Touch Concept option at no additional cost. Simply add 'SC' after the number and before 'MB' in the product code, e.g. MDW528SCMB. No handles are required for the Touch Concept option.

All single drawer basin modules have a U-shaped cut out to accommodate for plumbing. All deep drawer basin modules have a scooped back to accommodate for plumbing. On the 2 drawer basin modules, the top drawer has a U-shaped cut out, whilst the bottom drawer has a scooped back to accommodate for plumbing. All internal drawers within basin modules have a U-shaped cut out to accommodate for plumbing. Standard handle is included in the price of doored/drawer units. Height dimension includes basin where applicable.

MODULAR WALL HUNG BASIN AND STORAGE UNITS (cabinets only)

		Price Band 0	Price Band 1	Price Band 2
	SINGLE DRAWER BASIN MODULE* BASIN DRAWER (IF A STORAGE DRAWER IS REQUIRED, SIMPLY ADD STR AFTER THE NUMBER IN THE PRODUCT CODE)			
	500W x 465D x 280H	MODDW528	£273	£303
	600W x 465D x 280H	MODDW628	£302	£335
	800W x 465D x 280H	MODDW828	£347	£386
	DEEP DRAWER BASIN MODULE* BASIN DRAWER (IF A STORAGE DRAWER IS REQUIRED, SIMPLY ADD STR AFTER THE NUMBER IN THE PRODUCT CODE)			
	500W x 465D x 362H	MODDW536	£303	£337
	600W x 465D x 362H	MODDW636	£335	£373
	800W x 465D x 362H	MODDW836	£386	£428
	DEEP DRAWER BASIN MODULE WITH INTERNAL DRAWER BASIN DRAWER, INTERNAL DRAWER (IF A STORAGE DRAWER IS REQUIRED, SIMPLY REPLACE ID WITH STID IN THE PRODUCT CODE)			
	500W x 465D x 362H	MODDW536ID	£379	£421
	600W x 465D x 362H	MODDW636ID†	£419	£466
	800W x 465D x 362H	MODDW836ID†	£482	£536
	2 DRAWER BASIN MODULE* BASIN DRAWERS (IF A STORAGE DRAWER IS REQUIRED, SIMPLY ADD STR AFTER THE NUMBER IN THE PRODUCT CODE)			
	500W x 465D x 561H	MOD2DW556	£358	£398
	600W x 465D x 561H	MOD2DW656	£381	£424
	800W x 465D x 561H	MOD2DW856	£436	£485
	DOUBLE DOOR BASIN MODULE 2 DOORS, 1 SHELF			
	600W x 465D x 561H	MOD2DR656	£266	£295

*Please note that these units are also available as a Touch Concept option at no additional cost. Simply add 'SC' at the very end of the product code. No handles are required for the Touch Concept option.

†600W and 800W modular units with internal drawer are not compatible with slimline basins. All drawers within storage modules have full height backs. All single drawer basin modules have a U-shaped cut out to accommodate for plumbing. All deep drawer basin modules have a scooped back to accommodate for plumbing. On the 2 drawer basin modules, the top drawer has a U-shaped cut out, whilst the bottom drawer has a scooped back to accommodate for plumbing. All internal drawers within basin modules have a U-shaped cut out to accommodate for plumbing.

CURVED END MODULE UNIT

CURVED END MODULE
1 DOOR. AVAILABLE IN FIORA WHITE ONLY.
TO BE FITTED NEXT TO ANY SINGLE DEEP DRAWER MODULE.
EXCLUDES COUNTERTOP, TO BE ORDERED SEPARATELY

300W x 465D x 362H MODDR336CU



Price Band 1
£443



Standard handle is included in the price of doored/drawer units.

LOW WALL UNITS

Price Band 0 Price Band 1 Price Band 2

LOW WALL OPEN SHELF

1 SHELF

150W x 165D x 561H	LWGLOS155	£92	£92	£92
300W x 165D x 561H	LWGLOS35	£108	£108	£108
400W x 165D x 561H	LWGLOS45	£114	£114	£114
450W x 165D x 561H	LWGLOS455	£116	£116	£116

LOW WALL OPEN SHELF

1 SHELF

500W x 165D x 561H	LWGLOS55	£119	£119	£119
600W x 165D x 561H	LWGLOS65	£125	£125	£125
800W x 165D x 561H	LWGLOS85	£135	£135	£135

LOW WALL UNIT

1 DOOR, 1 SHELF

150W x 185D x 561H	LWC155	£123	£137	£143
300W x 185D x 561H	LWC35	£144	£160	£172
400W x 185D x 561H	LWC45	£151	£168	£180
450W x 185D x 561H	LWC455	£155	£172	£185

LOW WALL UNIT

2 DOORS, 1 SHELF

500W x 185D x 561H	LWC55	£186	£207	£222
600W x 185D x 561H	LWC65	£217	£241	£261
800W x 185D x 561H	LWC85	£234	£260	£281

LOW WALL MIRROR UNIT*†

1 MIRROR DOOR, 1 SHELF

300W x 185D x 561H	LWCM35	£224	£224	£224
400W x 185D x 561H	LWCM45	£240	£240	£240

LOW WALL MIRROR UNIT*†

2 MIRROR DOORS, 1 SHELF

500W x 185D x 561H	LWCM55	£310	£310	£310
600W x 185D x 561H	LWCM65	£362	£362	£362
800W x 185D x 561H	LWCM85	£389	£389	£389

LOW WALL STAINLESS STEEL MIRROR DOOR UNIT*

1 MIRROR DOOR, 1 SHELF

300W x 185D x 561H	LWCM35SL	£264	£264	£264
400W x 185D x 561H	LWCM45SL	£283	£283	£283

LOW WALL STAINLESS STEEL MIRROR DOOR UNIT*

2 MIRROR DOORS, 1 SHELF

500W x 185D x 561H	LWCM55SL	£356	£356	£356
600W x 185D x 561H	LWCM65SL	£416	£416	£416
800W x 185D x 561H	LWCM85SL	£447	£447	£447

HIGH WALL UNITS

Price Band 0 Price Band 1 Price Band 2

HIGH WALL OPEN SHELF

2 SHELVES

150W x 165D x 724H	HWGLOS157	£114	£114	£114
300W x 165D x 724H	HWGLOS37	£137	£137	£137
400W x 165D x 724H	HWGLOS47	£143	£143	£143
450W x 165D x 724H	HWGLOS457	£147	£147	£147

HIGH WALL OPEN SHELF

2 SHELVES

500W x 165D x 724H	HWGLOS57	£176	£176	£176
600W x 165D x 724H	HWGLOS67	£179	£179	£179
800W x 165D x 724H	HWGLOS87	£193	£193	£193

HIGH WALL UNIT

1 DOOR, 2 SHELVES

150W x 185D x 724H	HWC157	£146	£163	£172
300W x 185D x 724H	HWC37	£175	£195	£205
400W x 185D x 724H	HWC47	£184	£205	£215
450W x 185D x 724H	HWC457	£189	£210	£221

HIGH WALL UNIT

2 DOORS, 2 SHELVES

500W x 185D x 724H	HWC57	£226	£251	£265
600W x 185D x 724H	HWC67	£230	£256	£325
800W x 185D x 724H	HWC87	£247	£275	£349

HIGH WALL MIRROR UNIT*†

1 MIRROR DOOR, 2 SHELVES

300W x 185D x 724H	HWCM37	£273	£273	£273
400W x 185D x 724H	HWCM47	£287	£287	£287

HIGH WALL MIRROR UNIT*†

2 MIRROR DOORS, 2 SHELVES

500W x 185D x 724H	HWCM57	£377	£377	£377
600W x 185D x 724H	HWCM67	£383	£383	£383
800W x 185D x 724H	HWCM87	£412	£412	£412

HIGH WALL STAINLESS STEEL MIRROR DOOR UNIT*

1 MIRROR DOOR, 2 SHELVES

300W x 185D x 724H	HWCM37SL	£321	£321	£321
400W x 185D x 724H	HWCM47SL	£338	£338	£338

HIGH WALL STAINLESS STEEL MIRROR DOOR UNIT*

2 MIRROR DOORS, 2 SHELVES

500W x 185D x 724H	HWCM57SL	£433	£433	£433
600W x 185D x 724H	HWCM67SL	£441	£441	£441
800W x 185D x 724H	HWCM87SL	£474	£474	£474

HIGH WALL UNITS

Price Band 0	Price Band 1	Price Band 2
--------------	--------------	--------------

BI-FOLD UNIT

2 FRONTALS, 1 SHELF

500W x 185D x 724H	BIFC57	£272	£302	£318
600W x 185D x 724H	BIFC67	£276	£307	£390
800W x 185D x 724H	BIFC87	£297	£330	£419

TALL UNITS - FLOORSTANDING

Price Band 0	Price Band 1	Price Band 2
--------------	--------------	--------------

TALL STORAGE UNIT*

2 DOORS, 6 SHELVES

300W x 350D x 2043H	TSC3320	£328	£364	£452
---------------------	---------	------	------	------

TALL STORAGE UNIT WITH DRAWER*

2 DOORS, 1 DRAWER, 6 SHELVES

300W x 350D x 2043H	TSC3320D	£410	£455	£565
---------------------	----------	------	------	------

TALL STORAGE UNIT WITH OPEN SHELF*

2 DOORS, 4 GLASS SHELVES

300W x 350D x 2043H	TSC3320B	£328	£364	£452
---------------------	----------	------	------	------

TALL UNITS - WALL HUNG

Price Band 0	Price Band 1	Price Band 2
--------------	--------------	--------------

MODULAR TALL STORAGE UNIT WITH OPEN SHELF*

2 DOORS, 4 GLASS SHELVES

300W x 350D x 1793H	MODTSC3318	£328	£364	£452
---------------------	------------	------	------	------

MIRROR CABINETS

Available in Gloss Black, Gloss White and Oak

Price

OPEN SIDED MIRROR UNIT

304W x 220D x 1053H	OPSM3210	£171
---------------------	----------	------

SPINNING MIRROR UNIT

340W x 150D x 1090H 270D including bracket	SPM3110	£205
---	---------	------

CORNER POSTS

Available in all finishes. Supplied with Corner Base Units.

Price

BASE CORNER POST

122W x 30D x 720H	CPOSTB72	£81
-------------------	----------	-----

HIGH WALL CORNER POST

45W x 45D x 720H	CPOSTLW72	£81
------------------	-----------	-----

LOW WALL CORNER POST

45W x 45D x 561H	CPOSTLW56	£81
------------------	-----------	-----

BATH PANELS

Available in Gloss Black, Gloss White and Oak

Price

BATH END PANEL

800W x 440H	BEP844	£113
-------------	--------	------

BATH SIDE PANEL

1800W x 440H	BSP1844	£183
--------------	---------	------

BASIN & WC FASCIA PANELS

Available in all ranges

Price

FASCIA PANELS

500W x 159H	SRWC5P	£58
600W x 159H	SRWC6P	£59
800W x 159H	SRWC8P	£115

INFILL PANELS

for scribing against a wall

Available in Gloss Black, Gloss White and Oak (includes Edging Tape)

Price

BASE/WALL INFILL PANEL

300W x 811H x 18D	IP38	£10
-------------------	------	-----

TALL STORAGE INFILL PANEL

150W x 2043H x 18D	IP1520	£10
--------------------	--------	-----

BLENDER AND SHELVING PANELS

Range	Colour	Grain Direction	Blender Panels	Shelving Panels
Aviano	Matt Stone	Lengthways	352W x 18D x 970H BWU3597BT £51 750W x 18D x 2400H BLU7524BT £150	2600W x 352D x 18H SHPANELBT £188
Cambiano	Gloss Walnut	Lengthways	352W x 18D x 970H BWU3597BT £103 750W x 18D x 2400H BLU7524BT £337	2400W x 352D x 18H SHPANELBT £209
Carrara	Gloss White/ Grey	Widthways	352W x 18D x 970H BWU3597BT £80 750W x 18D x 2400H BLU7524BT £217	2400W x 352D x 18H SHPANELBT £209
Fiora Anthracite	Gloss Anthracite	N/A	352W x 18D x 970H BWU3597BT £80 750W x 18D x 2400H BLU7524BT £217	2600W x 352D x 18H SHPANELBT £209
Fiora Ivory	Gloss Ivory	N/A	352W x 18D x 970H BWU3597BT £80 750W x 18D x 2400H BLU7524BT £217	2600W x 352D x 18H SHPANELBT £209
Girona	Matt Light Ash	Widthways	352W x 18D x 970H BWU3597BT £51 750W x 18D x 2400H BLU7524BT £150	2600W x 352D x 18H SHPANELBT £188
Granada	Matt Dark Oak	Lengthways	352W x 18D x 970H BWU3597BT £51 750W x 18D x 2400H BLU7524BT £150	2600W x 352D x 18H SHPANELBT £188
Gloss Cashmere (Fiora Cashmere, San Marco Cashmere)	Gloss Cashmere	N/A	352W x 18D x 970H BWU3597BT £80 750W x 18D x 2400H BLU7524BT £217	2600W x 352D x 18H SHPANELBT £209
Gloss White (Castello, Fiora White, Serano White, Sizzano White, San Marco White)	Gloss White	N/A	352W x 18D x 970H BWU3597BT £80 750W x 18D x 2400H BLU7524BT £217	2400W x 352D x 18H SHPANELBT £209

Blender panels to be cut down as required. Edging Tape not included - order separately - see page 53.

BLENDER AND SHELVING PANELS

Range	Colour	Grain Direction	Blender Panels	Shelving Panels
Larino	Matt Walnut	Lengthways	352W x 18D x 970H BWU3597BT £51 600W x 18D x 2400H BLU7524BT £150	N/A
Marinella	Matt Oak	Lengthways	352W x 18D x 970H BWU3597BT £51 600W x 18D x 2400H BLU7524BT £217	N/A
Sizzano Dakar	Gloss Dakar	N/A	352W x 18D x 970H BWU3597BT £80 750W x 18D x 2400H BLU7524BT £217	2600W x 352D x 18H SHPANELBT £209
Sizzano Grey	Gloss Grey	N/A	352W x 18D x 970H BWU3597BT £80 750W x 18D x 2400H BLU7524BT £217	2600W x 352D x 18H SHPANELBT £209

Blender panels to be cut down as required. Edging Tape not included - order separately - see below.

PLINTHS

Available in all ranges

Price



PLINTHS

400W x 18D x 87H
600W x 18D x 87H
800W x 18D x 87H
2400W x 18D x 87H

PLINTH487P
PLINTH687P
PLINTH887P
PLINTH2487P

£10
£12
£14
£32

Gloss White, Linear, Sizzano and Fiora have no grain direction. Aviano, Cambiano, Girona, Granada, Larino and Marinella have a horizontal grain direction. Granada has a vertical grain direction. Carrara has a vertical grain direction on 2400mm plinths and a horizontal grain direction on 400mm, 600mm and 800mm plinths. Plinth Seal and Edging Tape are included with each 2400mm plinth.

PLINTH SEAL

3200W

PLINTHS

£11

PANEL ACCESSORIES

Price

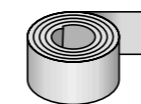

EDGING TAPE

1400L x 22H

Available in Gloss White (Serano White, Castello, Fiora White),
San Marco, Sizzano, Marinella, Larino and Fiora Ivory.

EDGSTRI14BT

£13

2400L x 22H

Available in Carrara, Cambiano, Fiora Anthracite and Gloss Cashmere
(Fiora and San Marco).

EDGSTRI24BT

£20

10000L x 22H

Available in Aviano, Girona and Granada.

EDGSTR2210BT

£20



INTRODUCING LINEAR

Linear is a stunning design style that creates a handleless finish, perfect for today's modern bathrooms.



LINEAR FIORA CASHMERE

The handleless style of Linear is shown off at its best in this gorgeous shade of gloss cashmere which, when combined with gloss cashmere replacement ends, creates a modern bathroom masterpiece.

Countertop shown: Brown Travertin laminate





LINEAR SIZZANO WHITE



Linear Sizzano White features a unique glass effect edging that gives a designer feel to any bathroom.

Countertop shown: Atlanta Marble laminate



FURNITURE PRICE GUIDE - LINEAR

RANGE SPECIFICATIONS - LINEAR

Linear handleless bathroom units are available as floorstanding units, wall units and modular wall hung units. The integrated trim needs to be ordered separately for base and modular units. The trim is pre-fitted to wall units.

HOW TO ORDER

- 1 Select your preferred range
- 2 Select your units and cabinet colour
Remember to state handing of your units (if applicable)
- 3 Order the appropriate length of trim (includes fixing clips)
- 4 On base units only, select either blender panels or end clips to finish the run of units
- 5 Decide on your countertop
- 6 Pick your accessories

LINEAR				CABINET COLOUR	
				<input type="text"/>	
				GLOSS WHITE Laser-edged MFC	
RANGE	LINEAR FIORA CASHMERE	LINEAR SIZZANO WHITE	LINEAR SERANO WHITE		
DESCRIPTION	Gloss Cashmere Painted MFC	Gloss White Painted MDF with glass effect edging	Gloss White PVC Wrapped Flat MDF Panel		
STD CABINET	Gloss White	Gloss White	Gloss White		

REPLACEMENT END PANELS

REPLACEMENT END PANELS ON LINEAR AVAILABLE FROM APRIL 2016



To enhance the finish of a selection of our bathrooms within the Linear Collection, replacement cabinet end panels are available to order at no extra cost if ordered with a unit.

The replacement end panels are designed to be used at the exposed ends of a unit run only.

On base units, the replacement cabinet end panel is a full length panel extending to the floor and therefore additional end blender panels will not be required.

Replacement cabinet ends are easy to order, simply add on one of the following suffixes to the standard unit code:

- For a replacement cabinet end to the **left** hand side of a unit add **GL** - for example SRBC638**GL**
- For a replacement cabinet end to the **right** hand side of a unit add **GR** - for example SRBC638**GR**
- For replacement cabinet ends to **both left and right** sides of a unit add **G2** - for example SRBC638**G2**

Please note that replacement end panels on Linear base units are not notched for the trim. Linear Serano White and Linear Sizzano White are available with replacement end panels on base units only. These are Gloss White MFC cabinet material. On Linear Serano White and Linear Sizzano White there are no options for replacement ends on wall units. Simply order with the Gloss White cabinet.

Range	Door Colour	Replacement End External Colour	Replacement End Internal Colour	Replacement End Grain Direction
Linear Gloss White (Base units only)	Gloss White	Gloss White Cabinet MFC	Gloss White Cabinet MFC	N/A
Linear Fiora Cashmere	Gloss Cashmere	Gloss Cashmere	Matt Cashmere	N/A

SANITARYWARE PACKS



S20 Back To Wall WC
Includes soft close seat
360W x 400H x 540D



S20 Wall Hung WC
Includes soft close seat
Requires Wall Hung Frame
360W x 350H x 520D



Wall Hung Frame
For Wall Hung WC
(not a Vitra product)
345W x 450H x 47D



S50 Back To Wall WC
Includes soft close seat
355W x 400H x 540D



Inline Sit-on Basin
Requires 600W cabinet
No worktop required
1 tap hole, reversible
Requires slotted waste
(not included)
Material: Marblecast
600W x 50H x 365D



Inline Sit-on Basin
Requires 800W cabinet
No worktop required
1 tap hole, reversible
Requires slotted waste
(not included)
Material: Marblecast
800W x 50H x 365D

Only the S50 standard depth round and S50 reduced depth basins are compatible with Linear due to the waste clashing with the trim. The critical distance between the rear face of the basin where it meets the frontal and centre of the waste is a minimum of 80mm.

Price



STANDARD DEPTH WC UNIT WITH CISTERN AND S20 BACK TO WALL WC†*

1 FIXED PANEL, 1 REMOVABLE PANEL, INCLUDES S20 BACK TO WALL WC, WITH DUAL FLUSH CONCEALED CISTERN. PLEASE ORDER APPROPRIATE TRIM, FIXING CLIPS AND END CAP(S) SEPARATELY

500W x 350D x 841H	WC53BPS20	£586
600W x 350D x 841H	WC63BPS20	£586



STANDARD DEPTH WC UNIT WITH CISTERN AND S20 WALL HUNG WC†*

1 FIXED PANEL, 1 REMOVABLE PANEL, INCLUDES S20 WALL HUNG WC, WALL HUNG FRAME WITH DUAL FLUSH CONCEALED CISTERN. PLEASE ORDER APPROPRIATE TRIM, FIXING CLIPS AND END CAP(S) SEPARATELY

500W x 350D x 841H	WC53WPS20	£847
600W x 350D x 841H	WC63WPS20	£847



STANDARD DEPTH WC UNIT WITH CISTERN AND S50 BACK TO WALL WC†*

1 FIXED PANEL, 1 REMOVABLE PANEL, INCLUDES S50 BACK TO WALL WC, WITH DUAL FLUSH CONCEALED CISTERN. PLEASE ORDER APPROPRIATE TRIM, FIXING CLIPS AND END CAP(S) SEPARATELY

500W x 350D x 841H	WC53BPS50	£644
600W x 350D x 841H	WC63BPS50	£644



SEMI-RECESSED BASIN UNIT

1 FIXED PANEL, 2 DOORS. INCLUDES INLINE BASIN. PLEASE ORDER APPROPRIATE TRIM, FIXING CLIPS AND END CAP(S) SEPARATELY

600W x 350D x 841H	SRBC63INB	£542
800W x 350D x 841H	SRBC83INB	£672

BASE UNIT TRIM OPTIONS

Price



BASE UNIT TRIM

CHROME, INCLUDES FIXING CLIPS
(3 WITH THE 1900MM AND 6 WITH THE 3800MM)

1900 x 60mm	LN MIDTRIM19B	£43
3800 x 60mm	LN MIDTRIM38B	£114

SCREW ON FIXING CLIPS

PAIR, INCLUDED WITH TRIM

1 per 600mm	LN FIXCLIPBT	£3
-------------	--------------	----

BASE UNIT TRIM END CAP

SINGLE, CHROME

75 x 30mm	LN MIDCAPBT	£43
-----------	-------------	-----

For trim see above, for plinth see page 67. †Cistern is supplied loose. *WC units are designed for the cistern to be front access only through the top fascia panel. Therefore the cistern needs to be front access and the push button/flush needs to have a flexible cistern connection to allow the panel to be removed.

STANDARD BASE UNITS

Price



BASE UNIT WITH DRAWER

1 DOOR, 1 SOFT CLOSE DRAWER, FULL EXTENSION. PLEASE ORDER APPROPRIATE TRIM, FIXING CLIPS AND END CAP(S) SEPARATELY

300W x 350D x 841H	BCTD338	£248
400W x 350D x 841H	BCTD438	£288



BASE UNIT WITH DRAWER

2 DOORS, 1 SOFT CLOSE DRAWER, FULL EXTENSION. PLEASE ORDER APPROPRIATE TRIM, FIXING CLIPS AND END CAP(S) SEPARATELY

500W x 350D x 841H	BCTD538	£327
600W x 350D x 841H	BCTD638	£384
800W x 350D x 841H	BCTD838	£413



TWO DRAWER BASE UNIT

SOFT CLOSE, FULL EXTENSION. PLEASE ORDER APPROPRIATE TRIM, FIXING CLIPS AND END CAP(S) SEPARATELY

400W x 350D x 841H	2DP438	£449
500W x 350D x 841H	2DP538	£471



TWO DRAWER BASE UNIT WITH INTERNAL DRAWER

SOFT CLOSE, FULL EXTENSION, 1 INTERNAL DRAWER. PLEASE ORDER APPROPRIATE TRIM, FIXING CLIPS AND END CAP(S) SEPARATELY

400W x 350D x 841H	2DP438ID	£536
500W x 350D x 841H	2DP538ID	£559



THREE DRAWER BASE UNIT

SOFT CLOSE, FULL EXTENSION. PLEASE ORDER APPROPRIATE TRIM, FIXING CLIPS AND END CAP(S) SEPARATELY

400W x 350D x 841H	3DP438	£593
500W x 350D x 841H	3DP538	£623



WC UNIT*

1 FIXED PANEL, 1 REMOVABLE PANEL. PLEASE ORDER APPROPRIATE TRIM, FIXING CLIPS AND END CAP(S) SEPARATELY

500W x 350D x 841H	WCC538	£259
600W x 350D x 841H	WCC638	£259



WC UNIT WITH CISTERN†*

1 FIXED PANEL, 1 REMOVABLE PANEL, WITH DUAL FLUSH CONCEALED CISTERN. PLEASE ORDER APPROPRIATE TRIM, FIXING CLIPS AND END CAP(S) SEPARATELY

500W x 350D x 841H	WCCPB538	£395
600W x 350D x 841H	WCCPB638	£395



SEMI-RECESSED BASIN UNIT

1 FIXED PANEL, 2 DOORS. PLEASE ORDER APPROPRIATE TRIM, FIXING CLIPS AND END CAP(S) SEPARATELY

500W x 350D x 841H	SRBC538	£318
600W x 350D x 841H	SRBC638	£335
800W x 350D x 841H	SRBC838	£418

For trim see page 62, for plinth see page 67.

†Cistern is supplied loose. *WC units are designed for the cistern to be front access only through the top fascia panel. Therefore the cistern needs to be front access and the push button/flush needs to have a flexible cistern connection to allow the panel to be removed.

MODULAR WALL HUNG BASIN UNITS

Use this section to view the large range of modular wall hung units we have to offer. Vanity unit modules include a matching basin making it as easy as possible to create your perfect bathroom.



Marblecast Basin
No worktop required
Requires slotted waste (not included)
Material: Marblecast
502W x 110H x 470D
602W x 110H x 470D



Slimline Sit-on Basin
No worktop required
Requires slotted waste (not included)
Not compatible with 280mm single drawer or units with internal drawers
Material: Marblecast
600W x 16H x 475D
800W x 16H x 475D



Slimline Basin Vanity Modules (includes basin and cabinet)

Price



DEEP DRAWER MODULE

BASIN DRAWER. INCLUDES SLIMLINE BASIN. NO WORKTOP REQUIRED. REQUIRES SLOTTED WASTE (NOT INCLUDED). PLEASE ORDER APPROPRIATE TRIM SEPARATELY

600W x 465D x 408H
800W x 465D x 408H

MDW636SB
MDW836SB

£630
£715

Marblecast Basin Vanity Modules (includes basin and cabinet)

Price



DEEP DRAWER MODULE

BASIN DRAWER. INCLUDES MARBLECAST BASIN. NO WORKTOP REQUIRED. REQUIRES SLOTTED WASTE (NOT INCLUDED). PLEASE ORDER APPROPRIATE TRIM SEPARATELY

500W x 465D x 502H
600W x 465D x 502H

MDW536MB
MDW636MB

£632
£663



DEEP DRAWER MODULE WITH INTERNAL DRAWER

BASIN DRAWER. INCLUDES MARBLECAST BASIN. NO WORKTOP REQUIRED. REQUIRES SLOTTED WASTE (NOT INCLUDED). PLEASE ORDER APPROPRIATE TRIM SEPARATELY

500W x 465D x 502H
600W x 465D x 502H

MDW536IDMB
MDW636IDMB

£724
£762

All single drawer basin modules have a U-shaped cut out to accommodate for plumbing. All deep drawer basin modules have a scooped back to accommodate for plumbing. All internal drawers within basin modules have a U-shaped cut out to accommodate for plumbing. Modular unit trim must be ordered separately - please see page 65. Height dimension includes basin where applicable.

MODULAR WALL HUNG BASIN UNITS

Price



DEEP DRAWER BASIN MODULE

BASIN DRAWER. PLEASE ORDER APPROPRIATE TRIM SEPARATELY (IF A STORAGE DRAWER IS REQUIRED, SIMPLY ADD STR AFTER THE NUMBER IN THE PRODUCT CODE)

500W x 465D x 392H
600W x 465D x 392H
800W x 465D x 392H

MODDW536
MODDW636
MODDW836

£368
£398
£458



DEEP DRAWER BASIN MODULE WITH INTERNAL DRAWER

BASIN DRAWER. PLEASE ORDER APPROPRIATE TRIM SEPARATELY (IF A STORAGE DRAWER IS REQUIRED, SIMPLY REPLACE ID WITH STID IN THE PRODUCT CODE)

500W x 465D x 392H
600W x 465D x 392H
800W x 465D x 392H

MODDW536ID
MODDW636ID*
MODDW836ID*

£459
£498
£572

*600W and 800W modular units with internal drawer are not compatible with slimline basins.

MODULAR UNIT TRIM OPTIONS

Price

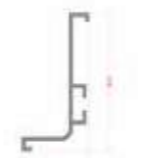

MODULAR UNIT TRIM

CHROME, INCLUDES FIXING CLIPS (2 WITH THE 500MM, 600MM AND 800MM AND 3 WITH THE 1900MM)

464 x 60mm
564 x 60mm
764 x 60mm
1900 x 60mm

LNTOPTRIM464
LNTOPTRIM564
LNTOPTRIM764
LNTOPTRIM19B

£12
£13
£18
£54

LOW WALL UNITS

Price



BRIDGING UNIT

1 LIFT UP DOOR

500W x 165D x 362H
600W x 165D x 362H
800W x 165D x 362H

LWBC536
LWBC636
LWBC836

£211
£248
£267



BRIDGING UNIT WITH ILLUMINATED BASE PANEL

1 LIFT UP DOOR

500W x 165D x 362H
600W x 165D x 362H

LWBC536IL
LWBC636IL

£380
£416

HIGH WALL UNITS

Price



HIGH WALL UNIT

1 DOOR, 2 SHELVES

300W x 185D x 724H
400W x 185D x 724H

HWC37
HWC47

£205
£215



HIGH WALL UNIT

2 DOORS, 2 SHELVES

500W x 185D x 724H
600W x 185D x 724H
800W x 185D x 724H

HWC57
HWC67
HWC87

£265
£325
£349

All drawers within storage modules have full height backs. All deep drawer basin modules have a scooped back to accommodate for plumbing. All internal drawers within basin modules have a U-shaped cut out to accommodate for plumbing. Modular unit trim must be ordered separately - please see page 65. Height dimension includes basin where applicable.

HIGH WALL UNITS

Price

HIGH WALL STAINLESS STEEL
MIRRORED DOOR UNIT

1 MIRROR DOOR, 2 SHELVES

300W x 185D x 724H	HWCM37SL	£321
400W x 185D x 724H	HWCM47SL	£338

HIGH WALL STAINLESS STEEL
MIRRORED DOOR UNIT

2 MIRROR DOORS, 2 SHELVES

500W x 185D x 724H	HWCM57SL	£433
600W x 185D x 724H	HWCM67SL	£441
800W x 185D x 724H	HWCM87SL	£474

BI-FOLD UNIT

1 SHELF

500W x 185D x 724H	BIFC57	£318
600W x 185D x 724H	BIFC67	£390
800W x 185D x 724H	BIFC87	£419

BI-FOLD UNIT WITH
ILLUMINATED BASE PANEL

1 SHELF

500W x 185D x 724H	BIFC57IL	£484
600W x 185D x 724H	BIFC67IL	£554

BATH PANELS

Available in Gloss Black, Gloss White and Oak

Price

BATH END PANEL

800W x 440H	BEP844	£113
-------------	--------	------

BATH SIDE PANEL

1800W x 440H	BSP1844	£183
--------------	---------	------

BASIN & WC FASCIA PANELS

Available in all ranges

Price

FASCIA PANELS

500W x 159H	SRWC5P	£58
600W x 159H	SRWC6P	£59
800W x 159H	SRWC8P	£115

INFILL PANELS

for scribing against a wall

Available in Gloss Black, Gloss White and Oak (includes Edging Tape)

Price

BASE/WALL INFILL PANEL

300W x 811H x 18D	IP38	£10
-------------------	------	-----

SHELVING PANELS

Price

GLOSS WHITE

2400W x 352D x 18H	SHPANELBT	£209
--------------------	-----------	------

GLOSS CASHMERE

2600W x 352D x 18H	SHPANELBT	£209
--------------------	-----------	------

BLENDER PANELS

To be cut down as required Edging Tape not included - order separately - see below

Price

GLOSS WHITE

352W x 18D x 970H	BWU3597BT	£80
750W x 18D x 2400H	BLU7524BT	£217

GLOSS CASHMERE

352W x 18D x 970H	BWU3597BT	£80
750W x 18D x 2400H	BLU7524BT	£217

PLINTHS

Available in all ranges

Price

PLINTHS

400W x 18D x 87H	PLINTH487P	£10
600W x 18D x 87H	PLINTH687P	£12
800W x 18D x 87H	PLINTH887P	£14
2400W x 18D x 87H	PLINTH2487P	£32

Plinth Seal and Edging Tape are included with the 2400mm plinth.

PLINTH SEAL

3200W	PLINTHS	£11
-------	---------	-----

PANEL ACCESSORIES

Price

EDGING TAPE

1400L x 22H	EDGSTRI14BT	£13
-------------	-------------	-----

Available in Gloss White (Serano White, Sizzano White).

EDGING TAPE

2400L x 22H	EDGSTRI24BT	£13
-------------	-------------	-----

Available in Gloss Cashmere (Fiore Cashmere).



INTRODUCING INLINE

The Inline handle trim takes the form of a wave, creating a contemporary finish to your bathroom.

Available in a range of finishes, the unique chrome handle fits the width of the door/drawer, making it both functional and visually stunning.



INLINE MATT - GRANADA



The dark shade of Granada is complemented by the bright chrome handle that sweeps the front of the drawer.

This look is enhanced by the matching Dark Oak 22mm countertop that is also used to frame the Fiora gloss white wall units.

Countertop shown: 22mm Dark Oak laminate





INLINE GLOSS - SIZZANO GREY

The duo-edging of Sizzano creates a glass effect finish that is complemented here by the Inline handle, creating a stunning contemporary finish.

Countertop shown: 22mm Gloss White laminate



FURNITURE PRICE GUIDE - INLINE

Available on a range of units and finishes, Inline is sure to make a statement within your bathroom.

HOW TO ORDER

- 1 Select your preferred range
- 2 Select your units and cabinet colour.
Remember to state handing of your units (if applicable)
- 3 Decide on your countertop
- 4 Pick your accessories



RANGE SPECIFICATIONS - INLINE

INLINE MATT

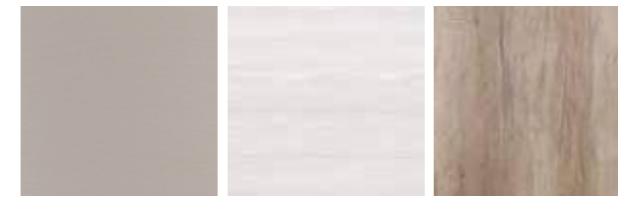

RANGE	AVIANO	GIRONA	GRANADA
DESCRIPTION	Matt Stone PVC-edged grained MFC	Light Ash PVC-edged cross-grained MFC	Dark Oak PVC-edged textured MFC
STD CABINET	Gloss White	Gloss White	Gloss Black

INLINE GLOSS

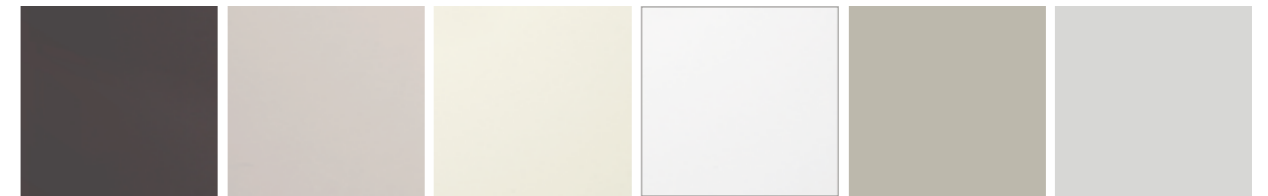

RANGE	FIORA ANTHRACITE	FIORA CASHMERE	FIORA IVORY	FIORA WHITE	SIZZANO DAKAR	SIZZANO GREY
DESCRIPTION	Gloss Anthracite Painted MFC	Gloss Cashmere Painted MFC	Gloss Ivory Painted MFC	Gloss White Painted MFC	Gloss Dakar Acrylic with glass effect edging	Gloss Grey Acrylic with glass effect edging
STD CABINET	Gloss Black	Gloss White	Gloss White	Gloss White	Gloss Black	Gloss Black

INLINE GLOSS



RANGE	SIZZANO WHITE
DESCRIPTION	Gloss White Painted MDF with glass effect edging
STD CABINET	Gloss White

CABINET COLOURS



GLOSS WHITE Laser-edged MFC



GLOSS BLACK Laser-edged MFC



OAK Laser-edged MFC

REPLACEMENT END PANELS

To enhance the finish of a selection of our bathrooms within the Inline Collection, replacement cabinet end panels are available to order at no extra cost if ordered with a unit.

The replacement end panels are designed to be used at the exposed ends of a unit run only.

Replacement cabinet ends are easy to order, simply add on one of the following suffixes to the standard unit code:

- For a replacement cabinet end to the **left** hand side of a unit add **GL** - for example MODDW528**GL**
- For a replacement cabinet end to the **right** hand side of a unit add **GR** - for example MODDW528**GR**
- For replacement cabinet ends to **both left** and **right** sides of a unit add **G2** - for example MODDW528**G2**

Range	Door Colour	Replacement End External Colour	Replacement End Internal Colour	Replacement End Grain Direction
Aviano	Matt Stone	Matt Stone	Matt Stone	Vertical
Fiora Anthracite	Gloss Anthracite	Gloss Anthracite	Matt Anthracite	N/A
Fiora Cashmere	Gloss Cashmere	Gloss Cashmere	Matt Cashmere	N/A
Fiora Ivory	Gloss Ivory	Gloss Ivory	Matt Ivory	N/A
Girona	Matt Light Ash	Matt Light Ash	Matt Light Ash	Horizontal
Granada	Matt Dark Oak	Matt Dark Oak	Matt Dark Oak	Vertical
Sizzano Dakar	Gloss Dakar	Gloss Dakar	Matt Dakar	N/A
Sizzano Grey	Gloss Grey	Gloss Grey	Matt Grey	N/A

MODULAR WALL HUNG BASIN UNITS

Use this section to view the large range of modular wall hung units we have to offer. Vanity unit modules include a matching basin making it as easy as possible to create your perfect bathroom.



Marblecast Basin
No worktop required
Requires slotted waste
(not included)
Material: Marblecast
502W x 110H x 470D
602W x 110H x 470D







Slimline Sit-on Basin
No worktop required
Requires slotted waste
(not included)
Not compatible with 280mm
single drawer or units with
internal drawers
Material: Marblecast
600W x 16H x 475D
800W x 16H x 475D



Slimline Basin Vanity Modules (includes basin and cabinet)





		Inline Matt	Inline Gloss	
	SINGLE DRAWER MODULE	BASIN DRAWER, INCLUDES SLIMLINE BASIN. NO WORKTOP REQUIRED. REQUIRES SLOTTED WASTE (NOT INCLUDED)		
	600W x 465D x 296H	MDW628SB	£558	£592
	800W x 465D x 296H	MDW828SB	£629	£667
	DEEP DRAWER MODULE	BASIN DRAWER, INCLUDES SLIMLINE BASIN. NO WORKTOP REQUIRED. REQUIRES SLOTTED WASTE (NOT INCLUDED)		
	600W x 465D x 378H	MDW636SB	£592	£629
	800W x 465D x 378H	MDW836SB	£667	£710
	2 DRAWER MODULE	BASIN DRAWERS, INCLUDES SLIMLINE BASIN. NO WORKTOP REQUIRED. REQUIRES SLOTTED WASTE (NOT INCLUDED)		
	600W x 465D x 577H	M2DW656SB	£663	£705
	800W x 465D x 577H	M2DW856SB	£743	£791

Marblecast Basin Vanity Modules (includes basin and cabinet)

		Inline Matt	Inline Gloss	
	SINGLE DRAWER MODULE	BASIN DRAWER, INCLUDES MARBLECAST BASIN. NO WORKTOP REQUIRED. REQUIRES SLOTTED WASTE (NOT INCLUDED)		
	500W x 465D x 390H	MDW528MB	£563	£593
	600W x 465D x 390H	MDW628MB	£591	£625
	DEEP DRAWER MODULE	BASIN DRAWER, INCLUDES MARBLECAST BASIN. NO WORKTOP REQUIRED. REQUIRES SLOTTED WASTE (NOT INCLUDED)		
	500W x 465D x 472H	MDW536MB	£593	£626
	600W x 465D x 472H	MDW636MB	£625	£662
	DEEP DRAWER MODULE WITH INTERNAL DRAWER	BASIN DRAWER, INCLUDES MARBLECAST BASIN. NO WORKTOP REQUIRED. REQUIRES SLOTTED WASTE (NOT INCLUDED)		
	500W x 465D x 472H	MDW536IDMB	£669	£711
	600W x 465D x 472H	MDW636IDMB	£709	£755
	2 DRAWER MODULE	BASIN DRAWERS, INCLUDES MARBLECAST BASIN. NO WORKTOP REQUIRED. REQUIRES SLOTTED WASTE (NOT INCLUDED)		
	500W x 465D x 671H	M2DW556MB	£673	£712
	600W x 465D x 671H	M2DW656MB	£696	£738

All **single drawer basin modules** have a U-shaped cut out to accommodate for plumbing. All **deep drawer basin modules** have a scooped back to accommodate for plumbing. On the **2 drawer basin modules**, the top drawer has a U-shaped cut out, whilst the bottom drawer has a scooped back to accommodate for plumbing. All **internal drawers within basin modules** have a U-shaped cut out to accommodate for plumbing. Standard handle is included in the price of doored/drawer units. Height dimension includes basin where applicable.

MODULAR WALL HUNG BASIN AND STORAGE UNITS

		Inline Matt	Inline Gloss
	SINGLE DRAWER BASIN MODULE BASIN DRAWER (IF A STORAGE DRAWER IS REQUIRED, SIMPLY ADD STR AFTER THE NUMBER IN THE PRODUCT CODE)		
500W x 465D x 280H	MODDW528	£298	£329
600W x 465D x 280H	MODDW628	£327	£361
800W x 465D x 280H	MODDW828	£372	£410
	DEEP DRAWER BASIN MODULE BASIN DRAWER (IF A STORAGE DRAWER IS REQUIRED, SIMPLY ADD STR AFTER THE NUMBER IN THE PRODUCT CODE)		
500W x 465D x 362H	MODDW536	£329	£362
600W x 465D x 362H	MODDW636	£361	£398
800W x 465D x 362H	MODDW836	£410	£454
	DEEP DRAWER BASIN MODULE WITH INTERNAL DRAWER BASIN DRAWER, INTERNAL DRAWER (IF A STORAGE DRAWER IS REQUIRED, SIMPLY REPLACE ID WITH STID IN THE PRODUCT CODE)		
500W x 465D x 362H	MODDW536ID	£404	£446
600W x 465D x 362H	MODDW636ID*	£444	£491
800W x 465D x 362H	MODDW836ID*	£507	£561
	2 DRAWER BASIN MODULE BASIN DRAWERS (IF A STORAGE DRAWER IS REQUIRED, SIMPLY ADD STR AFTER THE NUMBER IN THE PRODUCT CODE)		
500W x 465D x 561H	MOD2DW556	£408	£449
600W x 465D x 561H	MOD2DW656	£431	£473
800W x 465D x 561H	MOD2DW856	£487	£535

MODULAR CLOAKROOM UNIT



CLOAKROOM MODULAR WALL HUNG UNIT WITH BASIN

INCLUDES CLOAKROOM BASIN, 1 DOOR, 1 SHELF. NO WORKTOP OR PLINTH REQUIRED. REQUIRES SLOTTED WASTE (NOT INCLUDED)

		Inline Matt	Inline Gloss
400W x 220D x 561H (606H inc. basin)	MODCR456BAS	£378	£399

WALL UNITS



BI-FOLD UNIT

2 FRONTALS, 1 SHELF

		Inline Matt	Inline Gloss
500W x 185D x 724H	BIFC57	£297	£327
600W x 185D x 724H	BIFC67	£301	£332
800W x 185D x 724H	BIFC87	£322	£355

All drawers within **storage modules** have full height backs. All **single drawer basin modules** have a U-shaped cut out to accommodate for plumbing. All **deep drawer basin modules** have a scooped back to accommodate for plumbing. On the **2 drawer basin modules**, the top drawer has a U-shaped cut out, whilst the bottom drawer has a scooped back to accommodate for plumbing. All **internal drawers within basin modules** have a U-shaped cut out to accommodate for plumbing. Standard handle is included with the price of doored/drawer units.

*600W and 800W modular units with internal drawer are not compatible with slimline basins.

WALL UNITS

		Inline Matt	Inline Gloss
	HIGH WALL UNIT 1 DOOR, 2 SHELVES		
300W x 185D x 724H	HWC37	£200	£220
400W x 185D x 724H	HWC47	£210	£230
	HIGH WALL UNIT 2 DOORS, 2 SHELVES		
500W x 185D x 724H	HWC57	£276	£301
600W x 185D x 724H	HWC67	£281	£305
800W x 185D x 724H	HWC87	£297	£325
	BRIDGING UNIT 1 LIFT UP DOOR		
500W x 185D x 362H	LWBC536	£204	£223
600W x 185D x 362H	LWBC636	£233	£256
800W x 185D x 362H	LWBC836	£253	£272

TALL UNITS



WALL HUNG MODULAR TALL STORAGE UNIT WITH OPEN SHELF*

2 DOORS, 4 GLASS SHELVES

		Inline Matt	Inline Gloss
300W x 330D x 1793H	MODTSC3318	£377	£415

INFILL PANELS

for scribing against a wall. Available in Gloss Black, Gloss White and Oak (includes Edging Tape)

Price

BASE/WALL INFILL PANEL

300W x 811H x 18D	IP38	£10
-------------------	------	-----

BATH PANELS

Available in Gloss Black, Gloss White and Oak

Price

BATH END PANEL

800W x 440H	BEP844	£113
-------------	--------	------

BATH SIDE PANEL

1800W x 440H	BSP1844	£183
--------------	---------	------

BLENDER AND SHELVING PANELS

Please refer to pages 52-53 for a full list of blender and shelving panel prices and codes.

Standard handle is included with the price of doored/drawer units. *Wall hung. No plinth required.



INTRODUCING NAPLES

The in-frame painted collection of Naples combines heritage with elegance for a truly unique bathroom setting.

The Naples Collection combines freestanding and fitted units in an array of combinations to offer total flexibility - creating a real statement in any home.



NAPLES STONE



The Naples Collection combines heritage with elegance for a truly unique bathroom setting.

Handle shown: Polished chrome knob
CHOICE83

Countertop shown: Beige Tempest solid surface





NAPLES CLAY



Naples offers the designer the flexibility of creating freestanding-style modules or fitted furniture runs to suit each individual taste.

Handle shown: Rubbed bronze knob
CHOICE82

Countertop shown: Designer White solid surface



FURNITURE PRICE GUIDE - NAPLES

The Naples painted range includes 14 individual units which can be ordered in a freestanding or fitted configuration. The freestanding option includes two planked blender panels and the plinth with each unit for ease of ordering. These need to be ordered separately for the fitted option.

Also available are a matching framed mirror, blender panel, plinth and bath panels. All doors, blenders and plinths are painted to order on a four week lead time in either Clay or Stone. Countertops should be ordered separately.

HOW TO ORDER

- 1 Select your preferred range
- 2 Select your units and cabinet colour.
Remember to state handing of your units (if applicable)
- 3 Choose your handles
- 4 Decide on your countertop
- 5 Pick your accessories





RANGE SPECIFICATIONS - NAPLES

NAPLES

		
RANGE	NAPLES STONE	NAPLES CLAY
DESCRIPTION	Matt PVC Wrapped in-frame painted door	Matt PVC Wrapped in-frame painted door
STD CABINET	Gloss White	Gloss White
STD HANDLE	CHOICE83	CHOICE82

CABINET COLOURS

GLOSS WHITE Laser-edged MFC

OAK Laser-edged MFC





SANITARYWARE PACKS

						
S20 Back To Wall WC Includes soft close seat 360W x 400H x 540D	S20 Wall Hung WC Includes soft close seat Requires Wall Hung Frame 360W x 350H x 520D	Wall Hung Frame For Wall Hung WC (not a Vitra product) 345W x 450H x 47D	S50 Back To Wall WC Includes soft close seat 355W x 400H x 540D	S20 Standard Depth Basin 1 tap hole Requires slotted waste (not included) 550W x 170H x 440D	S50 Standard Depth Square Basin 1 tap hole Requires slotted waste (not included) 550W x 205H x 470D	S50 Standard Depth Round Basin 1 tap hole Requires slotted waste (not included) 550W x 185H x 450D

FREESTANDING BASE UNITS

Includes two blanked blender panels and plinth

Price

	SEMI-RECESSED BASIN UNIT WITH S20 STANDARD DEPTH BASIN FREESTANDING	1 FIXED PANEL, 2 DOORS, 1 SHELF, INCLUDES S20 STANDARD DEPTH BASIN
	636W x 352D x 811H	SRBC63S20FS £585
	WC UNIT WITH CISTERN AND S20 BACK TO WALL WC^{†A} FREESTANDING	1 FIXED PANEL, 1 REMOVABLE PANEL, INCLUDES S20 BACK TO WALL WC, WITH DUAL FLUSH CONCEALED CISTERN
	636W x 352D x 811H	WC63BPS20FS £726
	WC UNIT WITH CISTERN AND S20 WALL HUNG WC^{†A} FREESTANDING	1 FIXED PANEL, 1 REMOVABLE PANEL, INCLUDES S20 WALL HUNG WC, WALL HUNG FRAME WITH DUAL FLUSH CONCEALED CISTERN
	636W x 352D x 811H	WC63WPS20FS £986
	SEMI-RECESSED BASIN UNIT WITH S50 STANDARD DEPTH SQUARE BASIN FREESTANDING	1 FIXED PANEL, 2 DOORS, 1 SHELF, INCLUDES S50 STANDARD DEPTH SQUARE BASIN
	636W x 352D x 811H	SRBC63SS50FS £600

SEMI-RECESSED BASIN UNIT WITH S50 STANDARD DEPTH ROUND BASIN FREESTANDING

1 FIXED PANEL, 2 DOORS, 1 SHELF, INCLUDES S50 STANDARD DEPTH ROUND BASIN

636W x 352D x 811H

SRBC63RS50FS

£600

WC UNIT WITH CISTERN AND S50 BACK TO WALL WC FREESTANDING

1 FIXED PANEL, 1 REMOVABLE PANEL, INCLUDES S50 BACK TO WALL WC, WITH DUAL FLUSH CONCEALED CISTERN

636W x 352D x 811H

WC63BPS50FS

£783

FITTED BASE UNITS

SEMI-RECESSED BASIN UNIT WITH S20 STANDARD DEPTH BASIN FITTED

1 FIXED PANEL, 2 DOORS, 1 SHELF, INCLUDES S20 STANDARD DEPTH BASIN

636W x 352D x 811H

SRBC63S20

£453

WC UNIT WITH CISTERN AND S20 BACK TO WALL WC FITTED

1 FIXED PANEL, 1 REMOVABLE PANEL, INCLUDES S20 BACK TO WALL WC, WITH DUAL FLUSH CONCEALED CISTERN

636W x 352D x 811H

WC63BPS20

£605

WC UNIT WITH CISTERN AND S20 WALL HUNG WC FITTED

1 FIXED PANEL, 1 REMOVABLE PANEL, INCLUDES S20 WALL HUNG WC, WALL HUNG FRAME WITH DUAL FLUSH CONCEALED CISTERN

636W x 352D x 811H

WC63WPS20

£866

SEMI-RECESSED BASIN UNIT WITH S50 STANDARD DEPTH SQUARE BASIN FITTED

1 FIXED PANEL, 2 DOORS, 1 SHELF, INCLUDES S50 STANDARD DEPTH SQUARE BASIN

636W x 352D x 811H

SRBC63SS50

£468

SEMI-RECESSED BASIN UNIT WITH S50 STANDARD DEPTH ROUND BASIN FITTED

1 FIXED PANEL, 2 DOORS, 1 SHELF, INCLUDES S50 STANDARD DEPTH ROUND BASIN

636W x 352D x 811H

SRBC63RS50

£468

WC UNIT WITH CISTERN AND S50 BACK TO WALL WC FITTED

1 FIXED PANEL, 1 REMOVABLE PANEL, INCLUDES S50 BACK TO WALL WC, WITH DUAL FLUSH CONCEALED CISTERN

636W x 352D x 811H

WC63BPS50

£662

WC units excluding the cistern and push button are also available. Simply replace the 'P' with an 'A' in the product code, e.g. WC63BAS50FS.

Standard handle is included in the price of all doored/drawer units. †Cistern is supplied loose. ΔWC Units are designed for the cistern to be front access only through the top fascia panel. Therefore the cistern needs to be front access and the push button/flush needs to have a flexible cistern connection to allow the panel to be removed.

FREESTANDING BASE UNITS

Includes two planked blender panels and plinth

Price

BASE UNIT WITH DRAWER FREESTANDING

1 DOOR, 1 DRAWER, 1 SHELF

336W x 352D x 811H

BCTD338FS

£439

BASE UNIT WITH DRAWER FREESTANDING

2 DOORS, 1 DRAWER, 1 SHELF

636W x 352D x 811H

BCTD638FS

£571

SEMI-RECESSED BASIN UNIT FREESTANDING

1 FIXED PANEL, 2 DOORS, 1 SHELF

636W x 352D x 811H

SRBC638FS

£490

WC UNIT FREESTANDING

1 FIXED PANEL, 1 REMOVABLE PANEL

636W x 352D x 811H

WCC638FS

£398

WC UNIT WITH CISTERN FREESTANDING

1 FIXED PANEL, 1 REMOVABLE PANEL WITH DUAL FLUSH CONCEALED CISTERN

636W x 352D x 811H

WCCPB638FS

£535

FULL HEIGHT UNIT FREESTANDING

1 DOOR, 1 SHELF

336W x 352D x 811H

BC338FS

£395

FULL HEIGHT UNIT FREESTANDING

2 DOORS, 1 SHELF

636W x 352D x 811H

BC638FS

£474

Standard handle is included in the price of all doored/drawer units. †Cistern is supplied loose. ΔWC Units are designed for the cistern to be front access only through the top fascia panel. Therefore the cistern needs to be front access and the push button/flush needs to have a flexible cistern connection to allow the panel to be removed.

FITTED BASE UNITS

Price

BASE UNIT WITH DRAWER* FITTED

1 DOOR, 1 DRAWER, 1 SHELF

300W x 352D x 811H

BCTD338

£309

BASE UNIT WITH DRAWER* FITTED

2 DOORS, 1 DRAWER, 1 SHELF

600W x 352D x 811H

BCTD638

£480

*Plinth not included with units.

FITTED BASE UNITS

Price

**SEMI-RECESSED BASIN UNIT***
FITTED

1 FIXED PANEL, 2 DOORS, 1 SHELF

600W x 352D x 811H

SRBC638

£358

**WC UNIT**Δ**
FITTED

1 FIXED PANEL, 1 REMOVABLE PANEL

600W x 352D x 811H

WCC638

£278

**WC UNIT WITH CISTERN**†Δ**
FITTED

WITH DUAL FLUSH CONCEALED CISTERN

600W x 352D x 811H

WCCPB638

£414

**FULL HEIGHT UNIT***
FITTED

1 DOOR, 1 SHELF

300W x 352D x 811H

BC338

£240

**FULL HEIGHT UNIT***
FITTED

2 DOORS, 1 SHELF

600W x 352D x 811H

BC638

£320

Standard handle is included in the price of all doored/drawer units. *Plinth not included with units. †Cistern is supplied loose. ΔWC Units are designed for the cistern to be front access only through the top fascia panel. Therefore the cistern needs to be front access and the push button/flush needs to have a flexible cistern connection to allow the panel to be removed.

Price

**FRAMED MIRROR**

600W x 724H

FRMIR672

£113

**BLENDER PANEL**

352W x 18D x 811H

BCBP8135

£103

**PLINTH**

300W x 18D x 87H

PLINTH387P

£10

600W x 18D x 87H

PLINTH687P

£12

2400W x 18D x 87H

PLINTH2487P

£32

**BATH SIDE PANEL***

1700W x 22D x 440H

BSP1744

£142

BATH END PANEL*

750W x 22D x 440H

BEP744

£90

*Bath Panels are supplied with a plinth to enable the height to be adjustable between 440mm and 560mm.

ACCESSORIES

Make it personal by dressing up your furniture with our wide range of handles and countertops.

With the options available, you'll be sure to find what you're looking for – suitable for every mood.



HANDLES

SELECT YOUR HANDLES

There is a wide selection of standard handle options available for the Lindo Collection, these have 'CHOICE' numbers and are included in the price of your units.



CHOICE51
45mm Flat Square
Chrome knob
Handle Centres: **32**
£7



CHOICE54
Concave Satin Nickel
handle
Handle Centres: **128**
£7



CHOICE56
Small Chrome Bar
handle
Handle Centres: **128**
£5



CHOICE57
Large Chrome Bar
handle
Handle Centres: **320**
£17



CHOICE60
Chrome Chunky Square
'D' Bar handle
Handle Centres: **96**
£9



CHOICE61
Chrome Chunky Square
'C' knob
Handle Centres: **32**
£4



CHOICE62
Chrome Angled
'C' handle
Handle Centres: **32**
£5



CHOICE63
Chrome Square Curved
'D' Bar handle
Handle Centres: **128**
£8



CHOICE64
Chrome Bow handle
Handle Centres: **96**
£6



CHOICE65
Chrome Bow Cut
Out handle
Handle Centres: **96**
£6



CHOICE66
Chrome Square
Curved knob
Handle Centres: **32**
£13



CHOICE71
Chrome Glitter
Square knob
Handle Centres: **32**
£17



CHOICE72
Chrome Glitter
Bar handle
Handle Centres: **160/192**
£17



CHOICE73
Chrome Wave 'D'
handle
Handle Centres: **224**
£17



CHOICE74
Chrome Anthracite
handle
Handle Centres: **160/192**
£11



CHOICE75
Chrome Twist
handle
Handle Centres: **96**
£4



CHOICE76
Bright Chrome
Arrow handle
Handle Centres: **128**
£10



CHOICE77
Black Matt Pebble
knob
Handle Centres: **16**
£17



CHOICE78
Clear & Chrome
knob
Handle Centres: **64**
£12



CHOICE79
Rippled Chrome
handle
Handle Centres: **96**
£8



CHOICE80
Open Bright Chrome
handle
Handle Centres: **32**
£10



CHOICE81
Clear & Chrome 'D'
handle
Handle Centres: **128**
£10



CHOICE82
Rubbed Bronze knob
£12



CHOICE83
Polished Chrome knob
£10



CHOICE84
Fluted Chrome 'D' handle
Handle Centres: **128**
£5

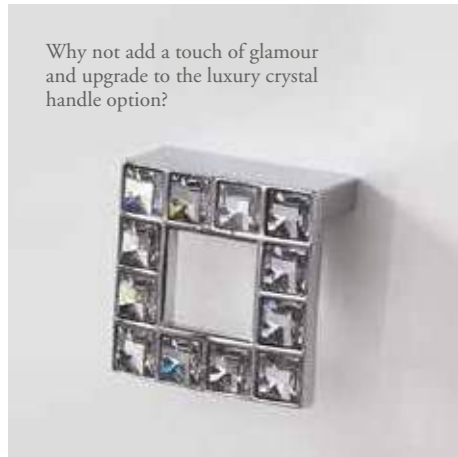

Why not add a touch of glamour and upgrade to the luxury crystal handle option?

LUXURY HANDLE OPTION
Chrome and Crystalized™ Swarovski Elements
pull handle. Featuring 12 genuine Swarovski crystals
in a stunning chrome finish. Handle Centres: **32**
LUXURY01* £60

*The Chrome and Crystalized™ Swarovski Elements pull handle (LUXURY01) is offered as an optional upgrade and is not free of charge. Because this is not offered as part of the standard handle offer you must first order your required units without handles. You will then be required to order the number of LUXURY01 handles you require separately for the items of furniture which you are ordering.

N.B. All handles shown above are not to scale. All handle centres are in mm. Please specify handle choice when ordering. Handles are only free of charge if ordered at the same time as your units.

HANDLES

N.B. All handles shown above are not to scale. All handle centres are in mm. Please specify handle choice when ordering. Handles are only free of charge if ordered at the same time as your units.

COUNTERTOPS

28mm LAMINATE COUNTERTOPS

Eleven gloss laminate square edged countertop finishes are available to co-ordinate across fitted and modular units. Edging tape is supplied with selected countertops.

LAMINATE COUNTERTOPS (Fitted & Modular Units)

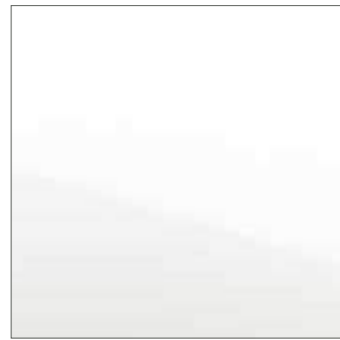

Gloss White



Italian Granite

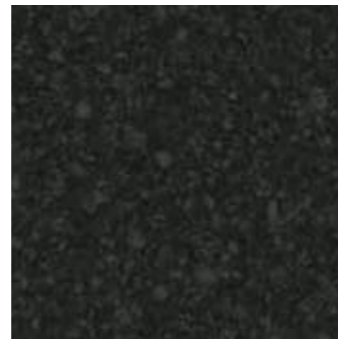

Taurus Black

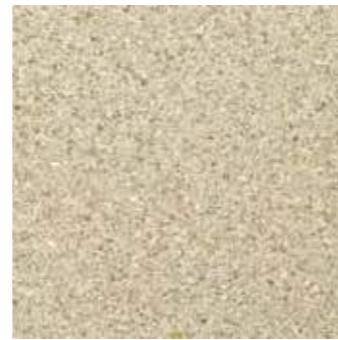

Taurus Beige

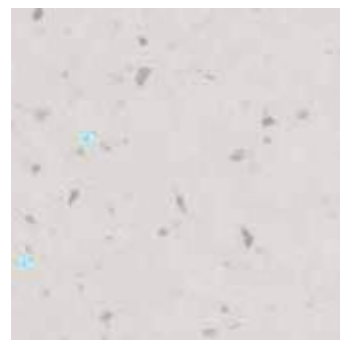

Taurus Crystal

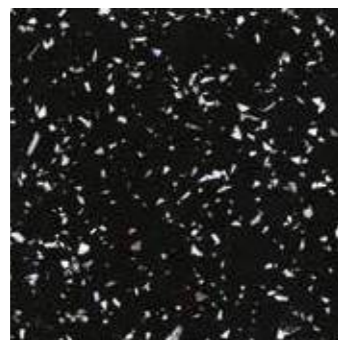

Strass Noir



Marble Noir



Atlanta Marble

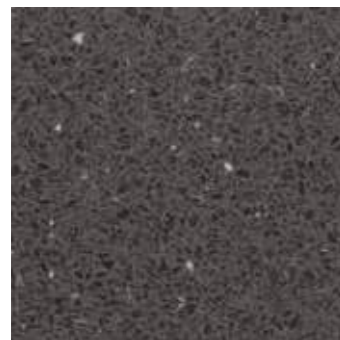

Lune



Ambria Marble



Brown Travertin

COUNTERTOPS

REDUCED DEPTH COUNTERTOP

28mm thick. For use with reduced depth units.

230mm D	2000mm L*	CT2023	£144
---------	-----------	--------	------

STANDARD DEPTH COUNTERTOPS

28mm thick. For use with standard depth units.

360mm D	346mm L [†]	CT336 [†]	£47
360mm D	605mm L	CT6036	£70
360mm D	646mm L [†]	CT636 [†]	£75
360mm D	1500mm L*	CT1536	£148
360mm D	2000mm L*	CT2036	£153
360mm D	3000mm L*	CT3036	£183

*Recommended for Naples. †Italian Granite and Marble Noir only.

CURVED STANDARD DEPTH COUNTERTOP

28mm thick. For use with standard depth units.

365mm D	3000mm L* (Double Ended Curved)	CT3036CU	£270
---------	---------------------------------	----------	------

Available in Gloss White, Marble Noir and Strass Noir only.

DEEP VANITY COUNTERTOP

28mm thick. For use with deep vanity units.

560mm D	2000mm L*	CT2056**	£170
---------	-----------	----------	------

MODULAR WALL HUNG COUNTERTOPS

28mm thick. For use with modular wall hung units.

475mm D	505mm L	CT547	£68
475mm D	605mm L	CT647	£74
475mm D	805mm L	CT847	£90
475mm D	1205mm L	CT1247	£134
475mm D	2000mm L*	CT2047	£166

CURVED MODULAR WALL HUNG COUNTERTOPS

28mm thick. For use with modular wall hung units.

475mm D	915mm L (Left Hand Curved)	CT947CUL	£145
475mm D	915mm L (Right Hand Curved)	CT947CUR	£145
475mm D	1220mm L (Double Ended Curved)*	CT1247CU	£196

Available in Gloss White, Marble Noir and Strass Noir only.

COUNTERTOP PVC EDGING TAPE

PVC edging available in all laminate countertop colours. 800mm L

CTEDG834PV	£15
------------	-----

*Includes Edging Tape.

COUNTERTOPS

30mm SOLID SURFACE COUNTERTOPS

Three solid surface countertops with a non porous solid acrylic surface bonded to a chipboard core, offering all the advantages of traditionally thicker solid surfacing but at a fraction of the cost.

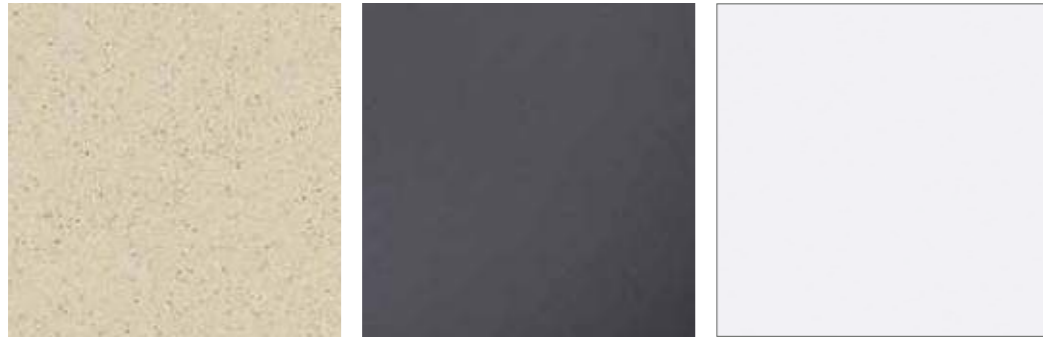

Beige Tempest

Carbon Odyssey

Designer White

STANDARD DEPTH COUNTERTOPS

For use with standard depth units.

360mm D	346mm L*	CTSS336	£91
360mm D	646mm L*	CTSS633	£225
360mm D	1804mm L	CTSS1830	£523

MODULAR UNIT COUNTERTOPS

For use with modular wall hung units.

470mm D	502mm L	CTSS530	£190
470mm D	602mm L	CTSS630	£250
470mm D	802mm L	CTSS830	£303

*Recommended for Naples.

SOLID SURFACE ACCESSORIES

Solid surface countertops can be cut and re-edged. An installation kit, cartridge and edging tape should be ordered for each countertop when joining and edging.

We recommend that a customer care kit is supplied with each countertop.

JOINING AND EDGING INSTALLATION KIT

SOINSTKITBT	£92
-------------	-----

Includes 1 bottle of Countertop Magic Cleaner, 4 alcohol wipes, 6 biscuit joints, 1 Scotch-Brite, 1 cloth, a selection of sanding discs and an installation booklet.

SOLID SURFACE ADHESIVE CARTRIDGE

SOCART50BT	£30
------------	-----

Includes a 50ml adhesive cartridge with 2 mixer tips.

SOLID SURFACE EDGING TAPE 400 x 32

EDGETSO4	£7
----------	----

APPLICATOR GUN

SOAPPGUNBT	£79
------------	-----

Includes a multiple use adhesive applicator gun.

SOLID SURFACE CUSTOMER CARE KIT

CTSSCARE	£53
----------	-----

Includes 1 bottle of Countertop Magic Cleaner, 1 cloth, 1 Scotch-Brite and a Care and Maintenance leaflet with DVD.

COUNTERTOPS

22mm COUNTERTOPS

These 22mm thick countertops are PVC edged all round, so can be used either as a countertop or as a blender panel on base and wall units to fully frame your units, giving you a stunning contemporary look.



Brazilia

Dark Oak

Designer White

For use with reduced depth units and high/low wall units

230mm D	2000mm L*	CT202322	£158
---------	-----------	----------	------

For use with standard depth units.

360mm D	2000mm L*	CT203622	£180
---------	-----------	----------	------

EDGING TAPE 3000mm

CTEDG328PV	£19
------------	-----

*The 2m lengths are supplied with edging tape.

30mm PVC WRAPPED COUNTERTOPS (Modular Wall Hung Units)

Two PVC countertops consisting of 30mm moisture-resistant PVC-wrapped MDF. Available for modular units only to co-ordinate with Gloss White and Oak ranges.

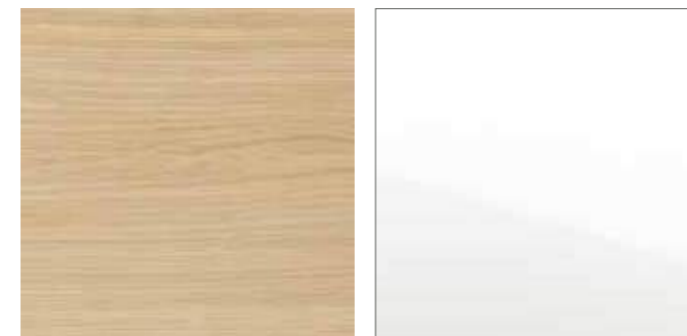

Oak

Gloss White

For use with modular units.

470mm D	502mm L	CTMR530	£105
470mm D	602mm L	CTMR630	£119
470mm D	802mm L	CTMR830	£145

For use with modular wall hung units

475mm D	505mm L	CT54722	£88
---------	---------	---------	-----

475mm D	605mm L	CT64722	£103
---------	---------	---------	------

475mm D	805mm L	CT84722	£124
---------	---------	---------	------

475mm D	2000mm L*	CT204722	£206
---------	-----------	----------	------

1200MM ONE PIECE BASIN AND COUNTERTOP†



1200mm one piece Softform basin and countertop.

Requires slotted waste (not included).

Designed to be used with a standard depth 600mm semi-recessed basin unit (SRBC638) and an additional standard depth 600mm unit (e.g. WC Unit or Base Unit)

Please specify the handing when ordering (e.g. L – Left Hand Basin)

1205W x 145H x 455D BASINSOFT12L £272

BASINSOFT12R £272

†Not recommended for use with San Marco

OPTIONS VESSEL BOWL

	Requires slotted waste (not included).
	420W x 160H x 420D VWBAS42 £233

Vitra

FINISHING TOUCHES

Personalise your bathroom with a wide range of practical and decorative accessories to make it truly unique.

From basins that suit every bathroom design to mirrors that light up to the latest LED strip lights and co-ordinating towel rail and glass shelves, Aquadi has all the finishing touches to create your perfect bathroom.



Complete your Aquadi bathroom with our range of co-ordinating accessories.

TAPS



Solo Basin Mixer tap
Includes slotted waste
Not compatible with the S50 reduced depth round semi-recessed basin
Minimum pressure required 0.5bar
159H
SAVV113 £179



Solo Bath Mixer tap
Minimum pressure required 0.5bar
140H
SAVV108 £282



Solo Tall tap
Includes slotted waste
Minimum pressure required 0.5bar
314H
SAVV113EX £242



Mini Basin Mixer tap
Includes slotted waste
Minimum pressure required 0.5bar
Ideal for use with reduced depth semi-recessed basin (SRBASINRD) 130H
VSN313 £142



Basin waste (slotted)
Order if additional wastes are required
BASINWASTE £31



Basin waste (unslotted)
Order if additional wastes are required
A351 £31

MIRRORS

Our range of mirrors includes illuminated mirrors with on/off sensors for LED lights, demister pads and shaving sockets as well as luxury mirror cabinets and wall mirrors.



Capella Mirror
LED Three Dimensional Infinity Mirror with Touch Sensor.
700H x 500W
MIRRORILUCAP £272



Enza Mirror
LED Mirror and Illuminated Glass Shelf.
LED Mirror with Demister Pad, Shaver Socket & Sensor Switch.
600H x 500
MIRRORILUENZ £258

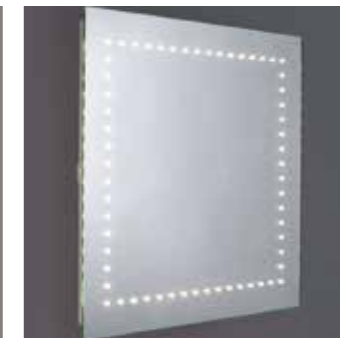

Savio Mirror
LED Mirror with Demister Pad, Shaver Socket & Sensor Switch.
600H x 600W
MIRRORILUSAV £283



Horizon Mirror
Fluorescent Illuminated Mirror with slimline Demister Pad, Shaver Socket & Sensor Switch.
600H x 1000W
MIRRORILUHOR £385



Lindo Oak Mirror
500W x 810H WM508MOD £227
600W x 810H WM608MOD £267
800W x 810H WM808MOD £357



Lindo White Mirror
500W x 810H WM508MOD £227
600W x 810H WM608MOD £267
800W x 810H WM808MOD £357

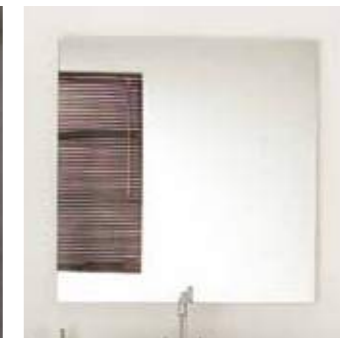

Frameless Mirror on white backboard
600W x 560H WM566 £63
600W x 724H WM672 £66
600W x 810H WM608 £68



Feature Mirror with adhesive back
1200W x 400H WM1240AD £75
1200W x 650H WM1265AD £97
1200W x 800H WM1280AD £116
with 2 glass shelves
1200W x 650H WM1265SHAD £190

ACCESSORIES



Top drawer organiser
Plastic insert with aluminium trim.
500W x 55H x 270D
BTDRWORG4 £74
600W x 55H x 270D
BTDRWORG5 £103



Expandable drawer storage
Set of 2 expandable frames for modular drawers and 2 drawer units.
236-286W x 129H
BTDRWSTREX £94

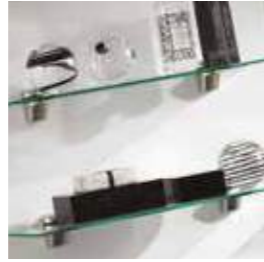

Glass shelving with nickel brackets
Includes 1 shelf and 2 brackets
600W x 200D
GLSHELF6NK £49



Square towel rail
300W x 50D
TOWELRAILSQ £34



Glass shelving with chrome brackets
Includes 1 shelf and 2 brackets
600W x 200D
GLSHELF6CX £49

UPSTANDS

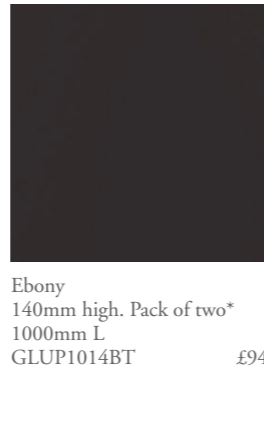

Bride
140mm high. Pack of two*
1000mm L
GLUP1014BT £94

Chalk
140mm high. Pack of two*
1000mm L
GLUP1014BT £94

Ebony
140mm high. Pack of two*
1000mm L
GLUP1014BT £94

Pewter
140mm high. Pack of two*
1000mm L
GLUP1014BT £94

*Glass is non-toughened so that it can be drilled and cut to size.

LIGHTS



IP Regulated LED Chrome Spotlight
Surface or recessed fitting.
Includes IP44 Driver and "Y" Splitter
LEDSURHDIP44 £112

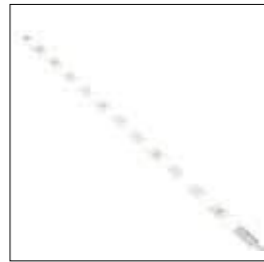

IP44 Flexible LED Strip Light Pack
Includes LED strip light, IP44 driver and link cable. Max 6 lights per driver
LEDFLX1BTPK £100



"Y" LED Strip Splitter for LEDFLEXI1BT. Use to split power cables for LEDFLEXI1BT, FLEXYSPLITBT £6



1000mm Connecting Cable for LEDFLEXI1BT. Use to connect driver to LEDFLEXI1BT light or to extend power from light strip to light strip
FLEXI1CON1 £4



IP 1000mm Flexible LED Strip Light. Cool white light output. Each light can be linked together by the connection cables at either end or with the link cable (FLEXI1CON1). The LED strip light is not cuttable. Driver not included. Clips provided for installation
LEDFLEXI1BT £68

COMPONENTS

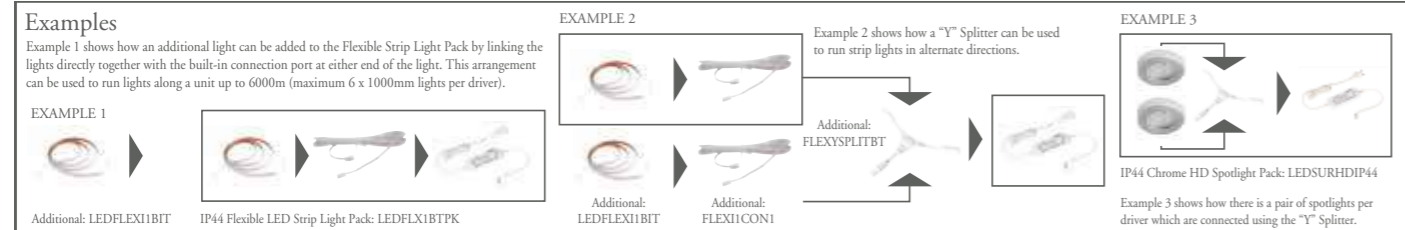

TECHNICAL GUIDE

GETTING STARTED

PLANNING GUIDE

CABINET SPECIFICATIONS

TECHNICAL INFORMATION

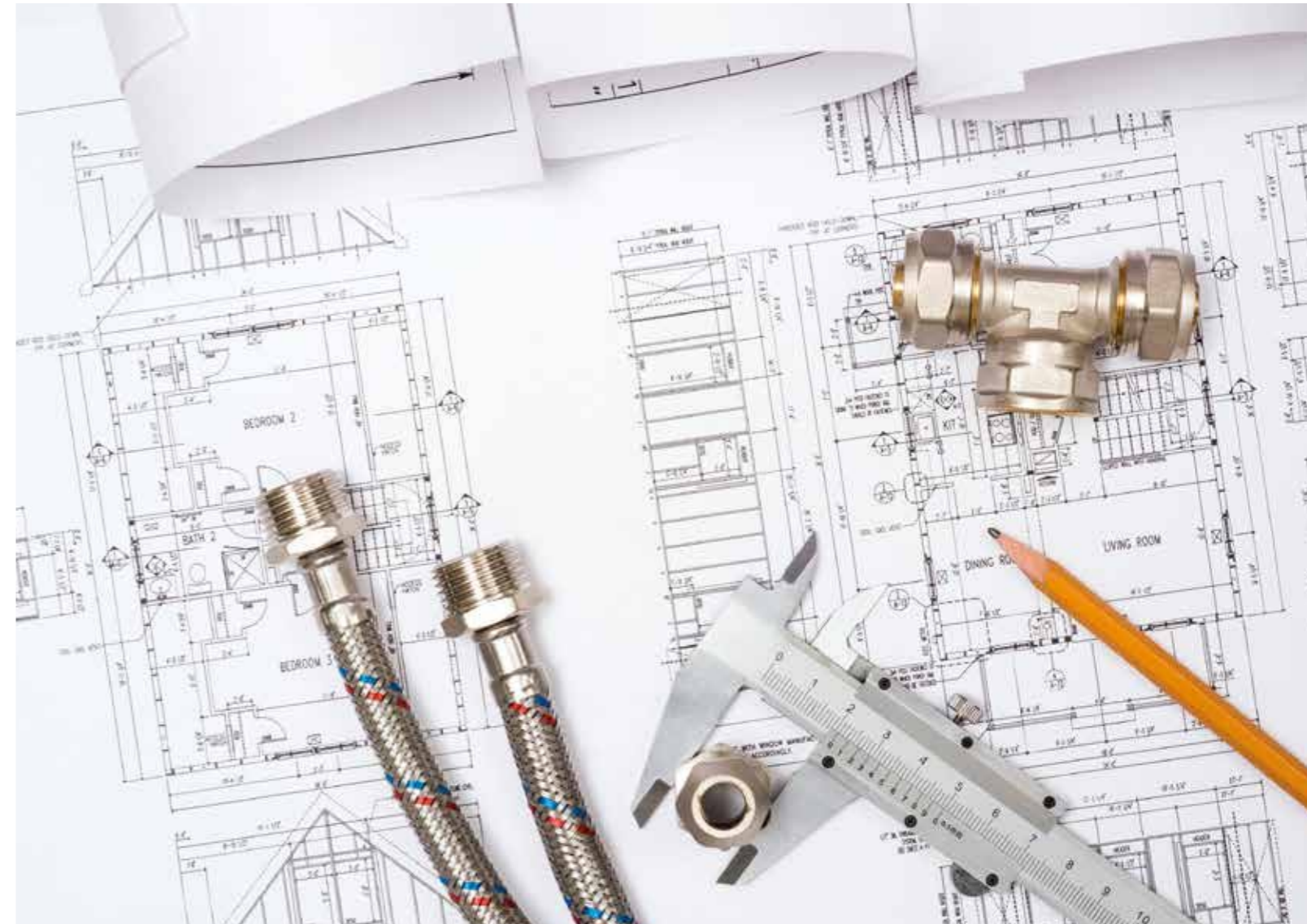

All Lindo Collection furniture is supplied in an assembled format only.
Aquadri bathroom furniture is subject to a ten year guarantee.

PLANNING GUIDE

Getting started

To begin with take an accurate measurement of your bathroom. Check the height from the floor to window sill to make sure that base units will fit underneath the window.

Check the dimensions and positions of windows, doors and any other obstructions, e.g. radiators, towel rails, soil and vent pipes and light switches, as these will determine the layout of your bathroom.

Transfer your room dimensions on to graph paper so that you can produce a scale drawing (use 1:10 or 1:20 scale). Mark the position of any waste pipes, soil pipes and incoming water supplies. The location of plumbing affects everything else, so this must be highlighted at the

start. Remember though that the beauty of fully fitted bathroom furniture is that your bathroom can be designed to completely conceal unsightly pipework.

Top Tip

If you are using wall units, try to get them to co-ordinate in size with your base units as this will be pleasing to the eye.

Top Tip

Always remember to allow for filler panels between a fitted unit and a wall. This prevents the unit door handle clashing against the wall and makes certain that the run of furniture will fit into your chosen space.

The next step is to list all the items you would like to have in your bathroom: shower, bath, hand basin, W/C, bidet, furniture pieces and storage units, mirror,

towel rail, etc. Obtain measurements of all these items and then add them to your plan. Full dimensions for all Aquadi bathroom furniture can be found in this Price Guide.

Once you have positioned your furniture on the plan you will be able to take final measurements of the runs of furniture and work out what size of countertop you will need.

Finally you can think about accessories. One of the most important things to consider is lighting. Aquadi offers a number of bathroom lighting options which are all IP regulated. You could choose LED Chrome Spotlights set into a flyover shelf, or flexible LED strip lighting underneath wall units. The illuminated mirrors are a 'must have' for any contemporary bathroom.



Space

The bathroom can often be one of the smallest rooms in the house, so if space is an issue or you are planning a cloakroom you may like to consider reduced depth bathroom furniture.

Aquadi offers a wide selection of base units with a depth of only 200mm across all ranges*. You may also like to consider the Cloakroom basin unit, a compact storage and basin solution which is perfect for smaller spaces.

Simple steps to select your furniture

Now that you have seen the style and choice that Aquadi has to offer and you have thought about the planning of your bathroom, simply follow the steps below to order your bathroom via your retailer.

1. Select your range.
2. Select style/colour.
3. Select your units and cabinet colour. Remember to state the handing of your units (if applicable).
4. Choose your handles.
5. Decide on your countertop.
6. Pick your accessories.

*Except Linear and Naples

CABINET SPECIFICATIONS

LINDO, INLINE AND NAPLES



Wall Unit Cabinet Design*

1. 18mm high density fully colour co-ordinated 0.8mm laser-edged MFC cabinet with matching interior/exterior finish.
2. Cam & dowel construction.
3. Two wall unit heights, 561mm and 724mm. 561mm are supplied with one glass shelf, 724mm are supplied with two glass shelves (shown here).
4. One-piece 8mm solid back
5. Concealed, fully adjustable wall hanging brackets.
6. 3-way fully adjustable all-metal clip-on hinge with integrated soft close buffer.
7. Double wall units available with mirrored doors.
8. Toughened 6mm glass shelf and chrome shelf bracket.

Modular Cabinet Design*

1. 18mm high density fully colour co-ordinated 0.8mm laser-edged MFC cabinet with matching interior/exterior finish.
2. Cam and dowel construction.
3. White metal sided drawer box with full extension, soft closing action, decorative chrome trim and frosted perspex sides.
4. Drawer boxes are shaped to accept wastes. Single, deep and 2 drawer units are additionally available in a full storage drawer option.
5. 18mm removable back with void of 50mm for pipes, etc.
6. Fully adjustable metal hanging brackets with nickel cover caps.



*Not available in Naples.

The Lindo Collection represents the latest design trends and features our unique fitted furniture concept. A 90mm high continuous plinth runs flush with the doors to give a contemporary linear styling and the 18mm cabinets are available in gloss black, gloss white and oak.

The Naples Collection incorporates the same high quality cabinet as Lindo with traditionally painted frontals. The 18mm cabinets are available in gloss white and oak.

The Inline Collection includes the same high quality modular and wall hung cabinet designs as Lindo with the chrome wave trim already attached.

The cabinet is designed to maximise storage space and features a concealed void at the back to allow for waste pipes.

All furniture is supplied in an assembled format only. Aquadi bathroom furniture is non-returnable and subject to a ten year guarantee.

Base Unit Cabinet Design*

(Standard Depth Units)

1. 18mm high density fully colour co-ordinated 0.8mm laser-edged MFC cabinet with matching interior/exterior finish.
2. Cam and dowel construction.
3. Toughened 6mm glass shelf and chrome shelf bracket.
4. 18mm MFC shelf.
5. Box at back of unit to run waste pipes along the concealed void if required. Side panel can be cut to fit pipes.
6. 8mm removable back with void of 75mm for pipes on basin units.
7. White metal sided drawer box with full extension, soft closing action and decorative chrome trim. Two drawer units feature frosted perspex sides.
8. 3-way fully adjustable all-metal clip-on hinge with integrated soft close buffer.
9. Supplied with four adjustable feet. These can be adjusted to raise the unit off the floor and to deal with uneven flooring.
10. Plinth clip for clip-on continuous plinth.
11. Wall and countertop fixing bracket are supplied (not illustrated).



*Not available in Inline.



Wall Unit Cabinet Design

1. 18mm high density Gloss White 0.8mm laser-edged MFC cabinet with matching interior/ exterior finish.
2. Cam & dowel construction.
3. Two wall unit heights, 561mm and 724mm.
4. One-piece 8mm solid back
5. Concealed, fully adjustable wall hanging brackets.
6. 3-way fully adjustable all-metal clip-on hinge with integrated soft close buffer.
7. Double wall units available with mirrored doors.
8. Toughened 6mm glass shelf and chrome shelf bracket.
9. Integrated concealed handle trim fitted.

Modular Cabinet Design

1. 18mm high density Gloss White 0.8mm laser-edged MFC cabinet with matching interior/ exterior finish.
2. Cam & dowel construction.
3. White metal sided drawer box with full extension, soft closing action, decorative chrome trim and frosted perspex sides.
4. Drawer boxes are shaped to accept wastes and are additionally available in a full storage drawer option.
5. 18mm removable back with void of 50mm for pipes, etc.
6. Fully adjustable metal hanging brackets with nickel cover caps.
7. Cabinet is not notched. Trim and fixing clips ordered separately.



Linear is a stunning design style that creates a handleless finish perfect for today's modern bathrooms. A 90mm high continuous plinth runs flush with the doors to give a contemporary linear styling.

The cabinet is designed to maximise storage space and features a concealed void at the back to allow for waste pipes. Linear handleless bathroom units are available on floorstanding units, wall units and modular wall hung units. The integrated trim needs to be ordered separately for base and modular units, it is pre-fitted in wall units.

Base Unit Cabinet Design

(Standard Depth Units)

1. 18mm high density Gloss White 0.8mm laser-edged MFC cabinet with matching interior/ exterior finish.
2. Cam & dowel construction.
3. Toughened 6mm glass shelf and chrome shelf bracket.
4. 18mm MFC shelf.
5. Box at back of unit to run waste pipes along the concealed void if required. Side panel can be cut to fit pipes.
6. 8mm removable back with void of 75mm for pipes on basin units.
7. White metal sided drawer box with full extension, soft closing action and decorative chrome trim. Two drawer units feature frosted perspex sides.
8. 3-way fully adjustable all-metal clip-on hinge with integrated soft close buffer.
9. Supplied with four adjustable feet. These can be adjusted to raise the unit off the floor and to deal with uneven flooring.
10. Plinth clip for clip-on continuous plinth.
11. Wall and countertop fixing bracket are supplied (not illustrated).
12. Cabinet supplied ready notched to accept trim.



TECHNICAL INFORMATION

LINDO FITTED UNIT DIMENSIONS (INCLUDING NAPLES)†

Available Widths and Heights (mm)



*Height based on nominal 30mm countertop.

†Naples only available in 300mm and 600mm base units, 600mm basin unit and 600mm WC unit.

TECHNICAL INFORMATION

LINEAR FITTED UNIT DIMENSIONS

Available Widths and Heights (mm)



Fitted Units/Heights and Depths (mm)

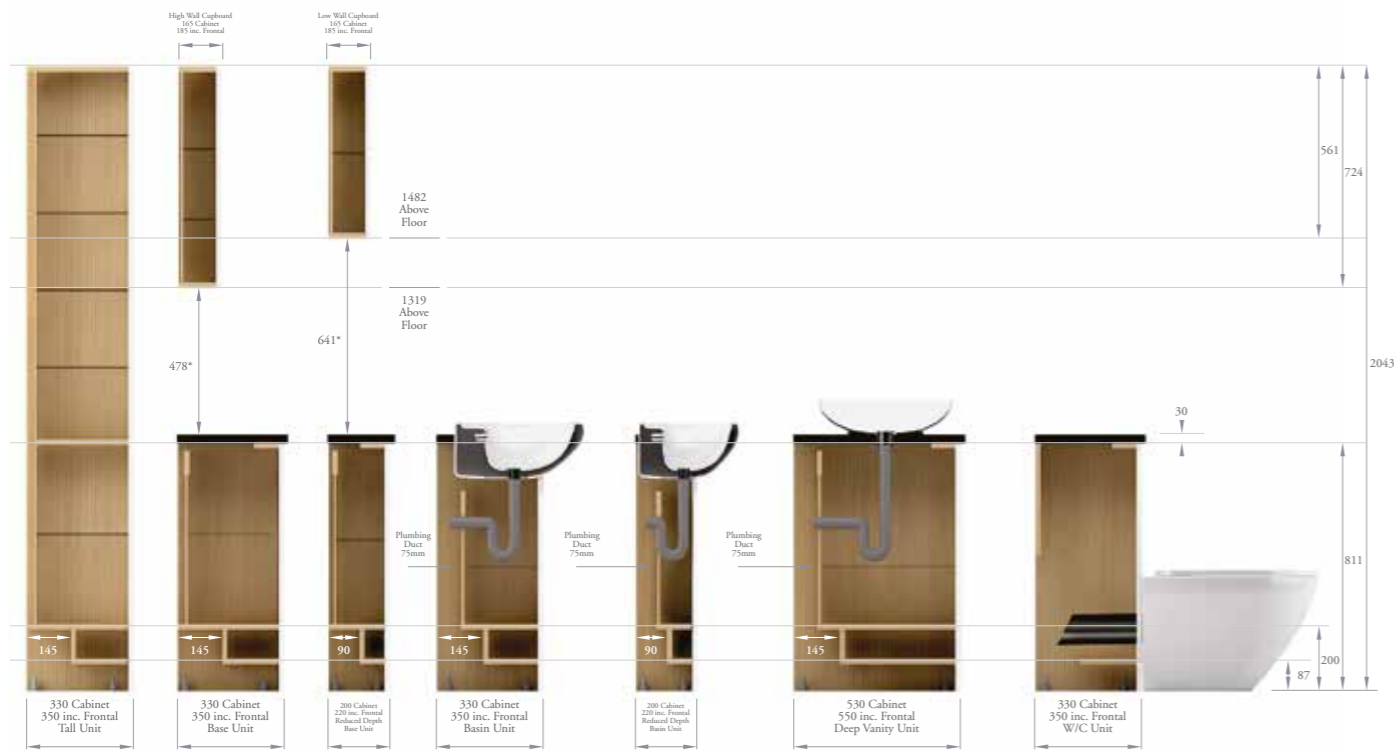

*Height based on nominal 30mm countertop.

Modular Wall Hung Units/Available Widths (mm)



Cloakroom Units - Internal Specification Modular Cloakroom Unit



Floor Standing Cloakroom Unit

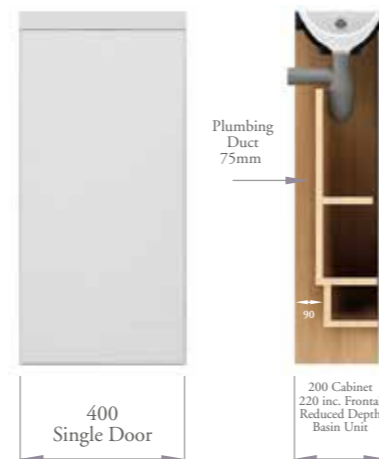

Modular Wall Hung Units - Internal Specification



Installation Guide

Always check for electrical wires, water pipes or other services before drilling the wall.

Lindo Base Units

Set height for base units at 811mm on wall above lowest point. Plumb and secure firmly through back rail and brackets. Adjust leg for base support. Scribe into side panels and plinth as required. It is recommended to seal plinth with plinth seal (PLINTHS). Continue adding adjoining units, screwing or bolting together and fixing as above. The Lindo Collection base units are boxed out at the rear to allow waste pipes to be run along the back of the units. In this scenario cut out the back of the side panel as required to fit/hold waste pipes (see below).



Lindo Wall Units

Determine the exact location of the unit(s) and mark a horizontal line 1831mm from the floor. Mark the position of each unit.

Fit the hanging bracket plates to the wall as illustrated and use adjustment to level. Secure with additional fixings through back support rail or bracket. Continue adding adjoining units, screwing or bolting together and fixing as above.

Modular Units

Firmly screw brackets to wall and use adjustment to level. Secure with additional fixings through back support rail or bracket.

IMPORTANT

All units should be fitted by a qualified fitter. Any screws and other fixings used must be suitable to support the units when loaded into the material they are to be fitted.

When fitting handles please be aware that doors are not pre-drilled for the handle. The drillings on the doors may be different between two doors in the same range, so we strongly recommend that each handle is measured and the door marked and drilled to fit the handle.

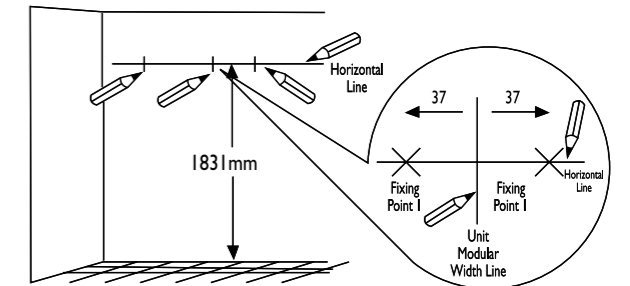

Installation Sequence

1. All hot and cold services turned off at appropriate positions.
2. Locate waste outlets according to the plan.
3. Fix base units to the wall.
4. Fit countertops.
5. Fit sanitaryware.
6. Fit wall units where appropriate.
7. Connect and check plumbing.
8. Fit continuous plinth if used, scribing as necessary.

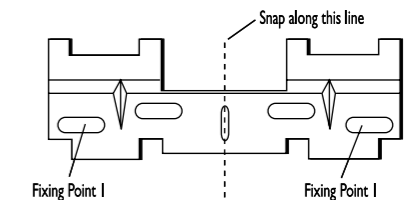

Corner Planning

Base Units

The Base Corner Unit is offset either 60mm or 75mm from the wall depending on the range ordered. The adjacent unit needs to be offset either 360mm or 375mm from this wall.

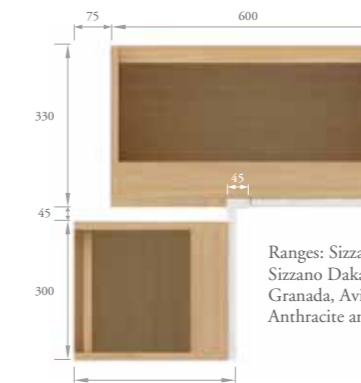
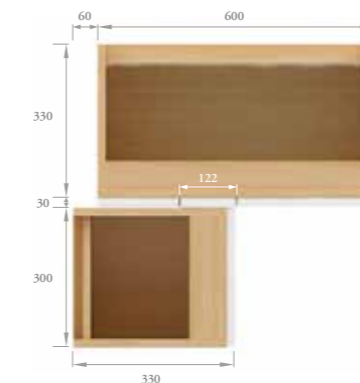

Ranges: Sizzano Grey, Sizzano Dakar, Carrara, Granada, Aviano, Fiora Anthracite and Cashmere

Wall Units

The Wall Units should be offset 210mm from the adjacent wall.

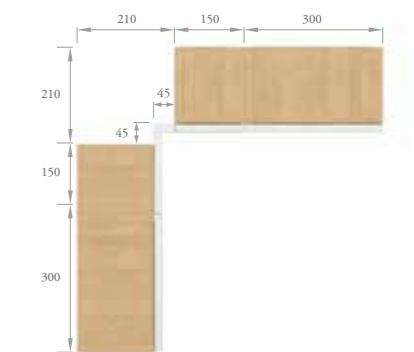

LINEAR BASE UNITS - HANDLE TRIM FITTING

LINEAR MODULAR UNITS - HANDLE TRIM FITTING

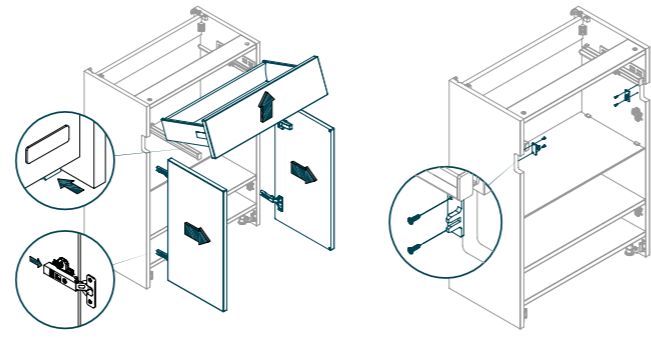
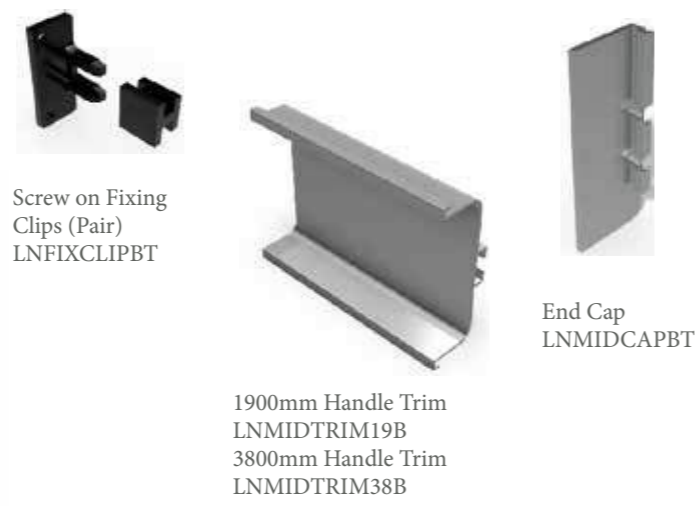
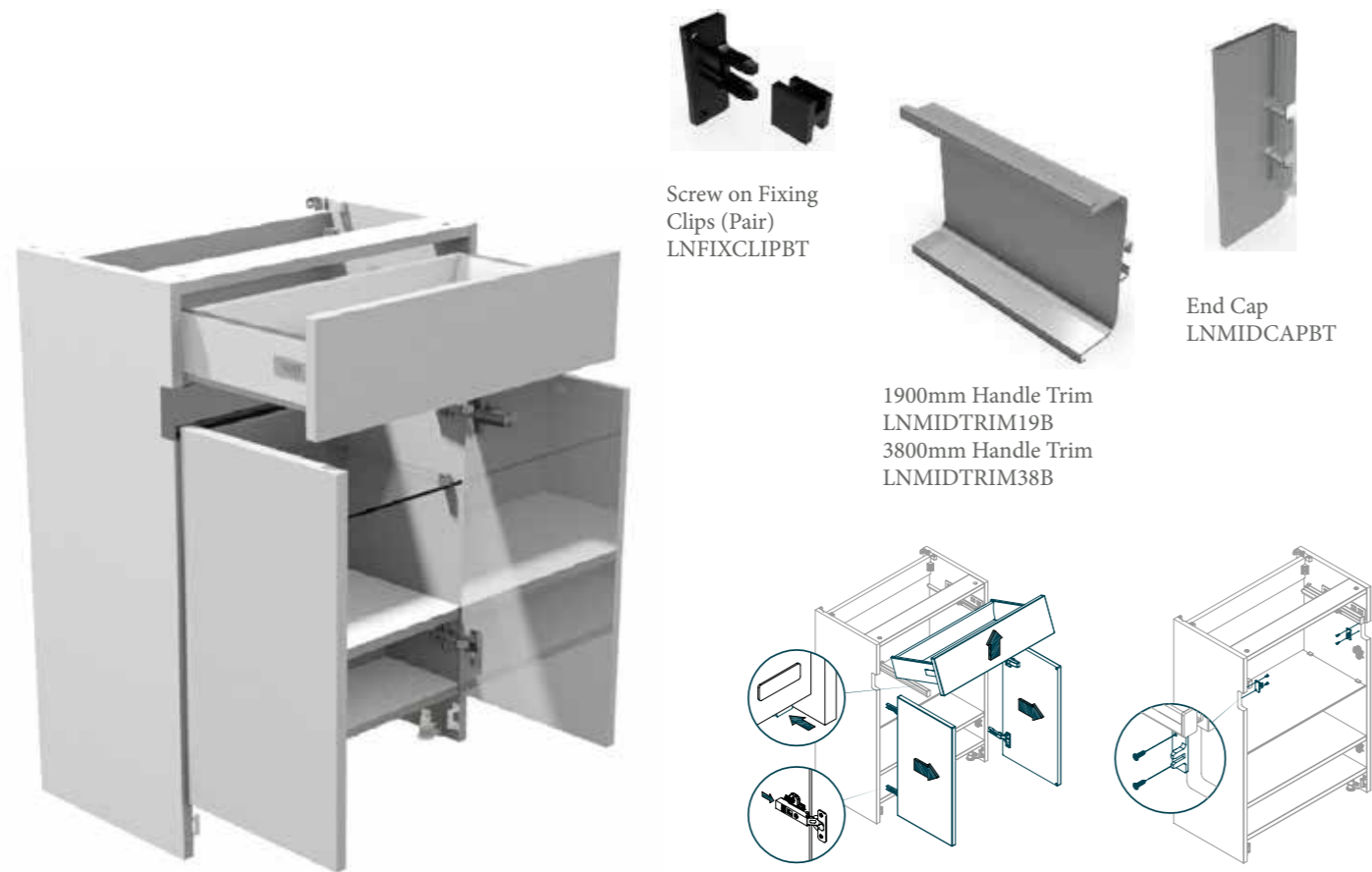

1. Once all units have been fitted, remove all frontal and drawers to allow fitting of the handle trim.
2. Fix the trim fixing brackets to the unit using 2x 0.5"x6 screws.

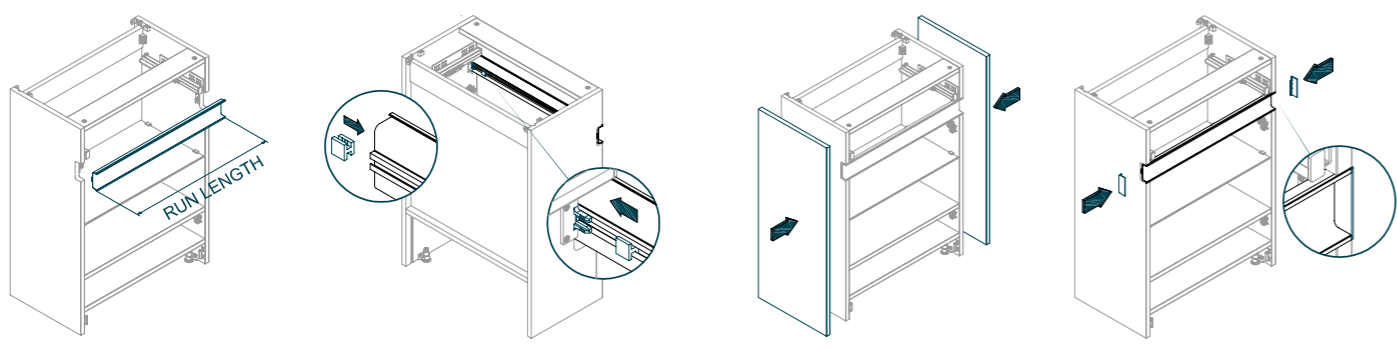

3. Determine the run length and cut the trim to suit. **Note:** If using end caps the trim will be smaller than the total run length by 2mm per cap.
4. Insert the fixing bracket lugs into the back of the trim and fix by clipping the lugs into the fixing brackets.
5. It is recommended to finish a run by using blender panels.
6. Alternatively, replacement ends or end caps can be used to finish a run.

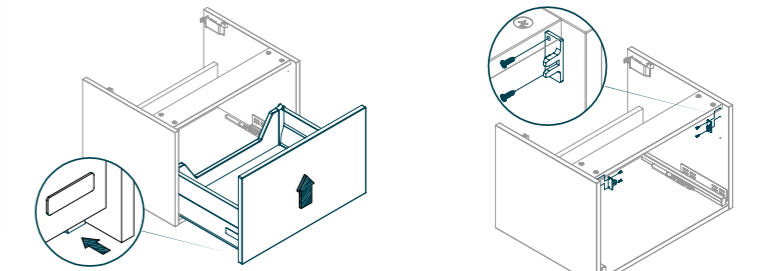
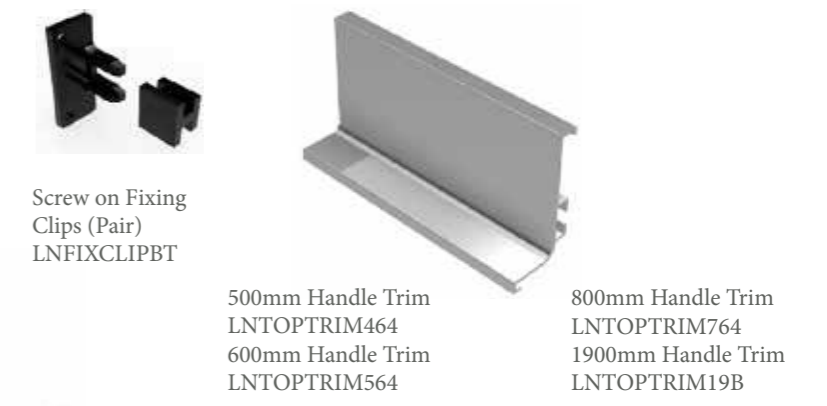
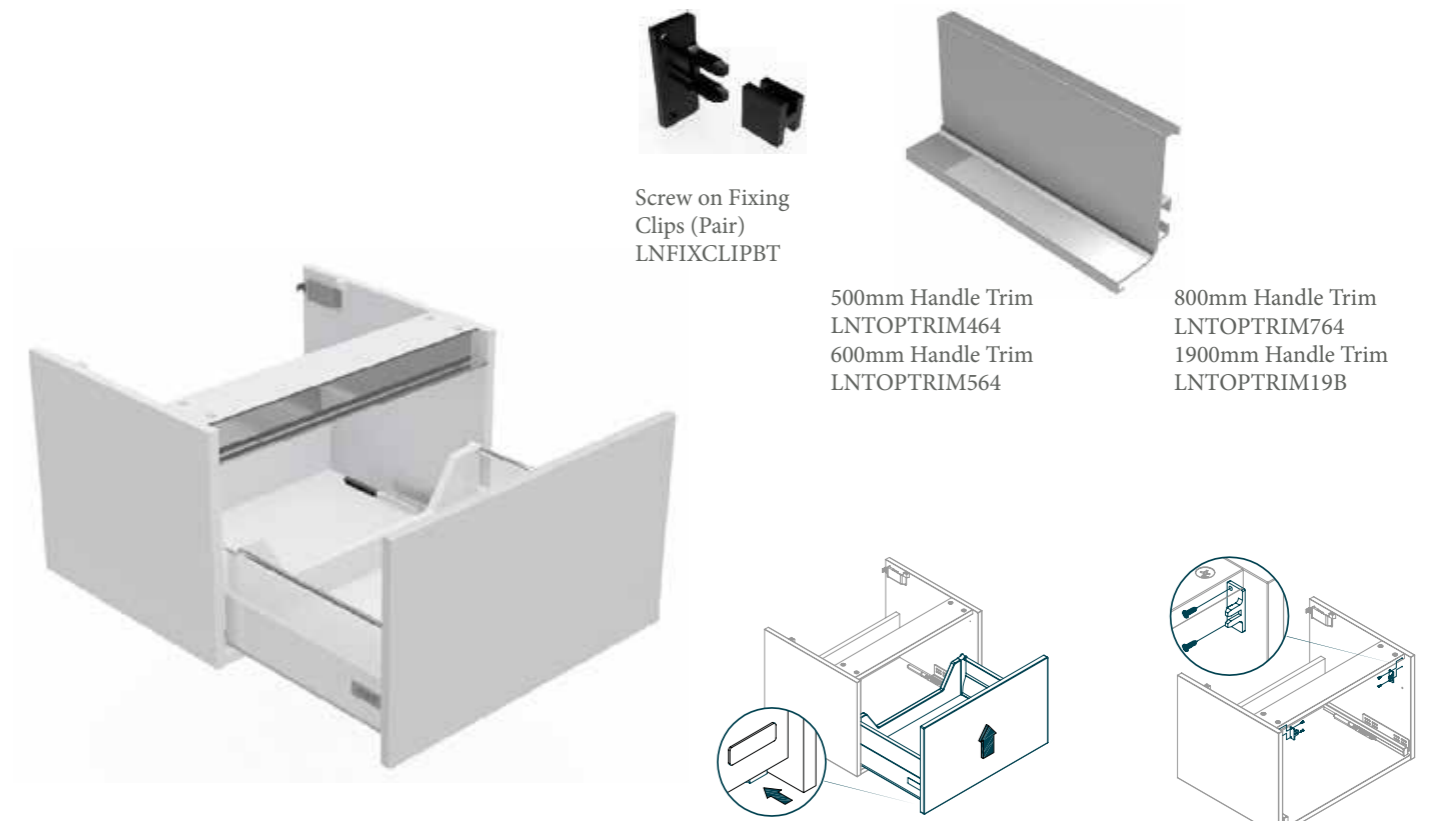

1. Once all units have been fitted, remove the drawers to allow fitting of the handle trim. **Note:** The handle trim should be fitted prior to fitting the countertop.
2. Fix the trim fixing brackets to the unit using 2x 0.5"x6 screws.

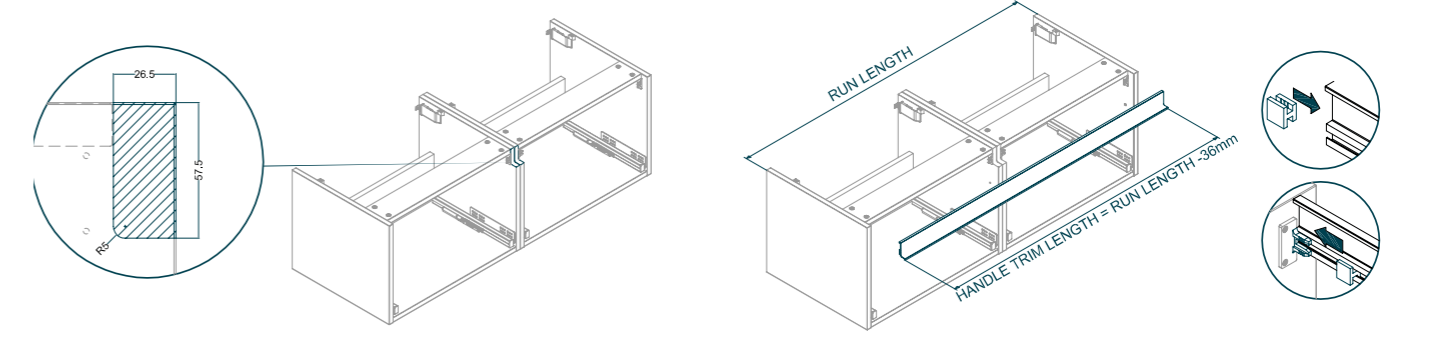

3. (Optional) To achieve a continuous handle trim when joining multiple units together, the joining side panels require notching.
4. (Optional) Determine the run length and cut the trim to suit.



- 1 Fiora Cashmere matches Urbano's Solar Gloss Cashmere
- 2 Naples Clay matches Urbano's Lunar Painted Clay



Co-ordinate your en-suites

What could be nicer than walking into a beautiful en-suite with all the style and panache of your sleek Urbano bedroom?

With a range of en-suites available from our fabulous Lindo range designed to fully co-ordinate with our Urbano bedrooms, you can easily create a seamless look throughout.



urbano[®]
by Symphony[®]

Aquadi...

Aquadi bathroom products are available from specialist interior retailers throughout the UK and Ireland. To find out more about our products and to locate your nearest retailer please log on to www.symphony-group.co.uk/aquadi

...by Symphony

Other brands within the Symphony Group include Gallery Kitchens and Urbano Bedroom Furniture. To find out more about these brands please visit www.symphony-group.co.uk

To find out more about co-ordinating Urbano bedrooms and to order a bedroom brochure please log on to www.symphony-group.co.uk/urbano



The FSC logo means that the paper used to produce this brochure is certified by the Forest Stewardship Council and comes from well managed forests and company controlled sources. FSC is an independent global organisation that sets standards for responsible forest management which support forest communities and protects the environment.

For more information see www.fsc-uk.org