

Luxury Bathroom Solutions *WAVE-Horizontal*

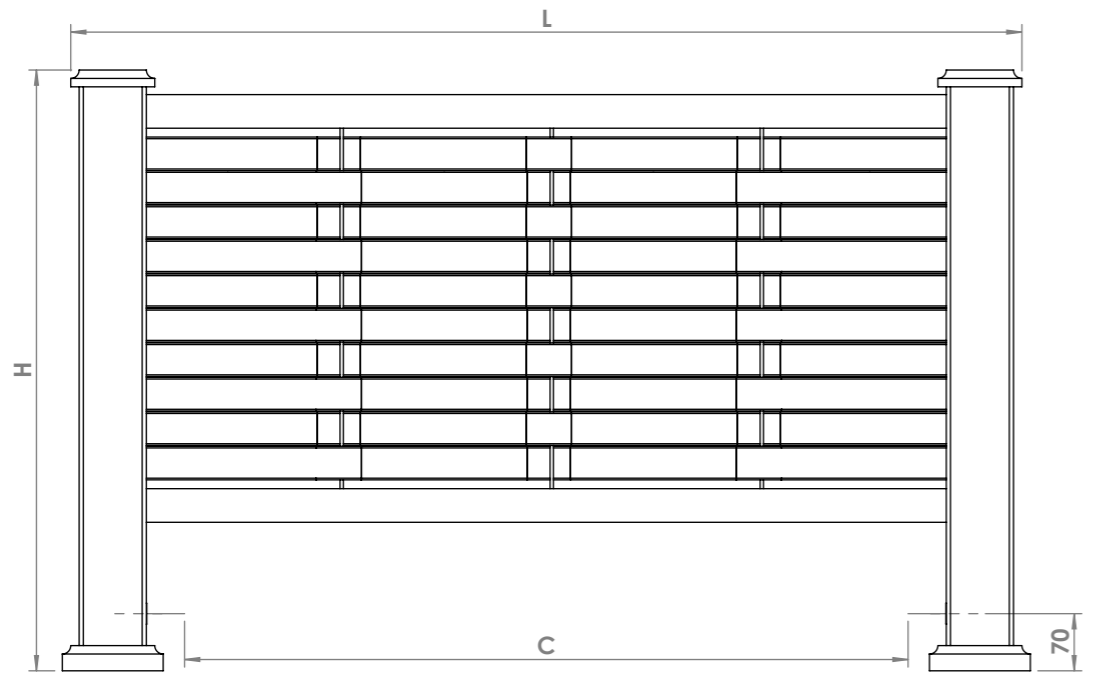

Front View

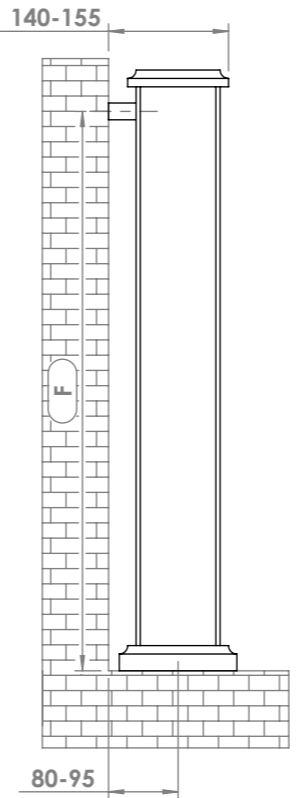

Side View

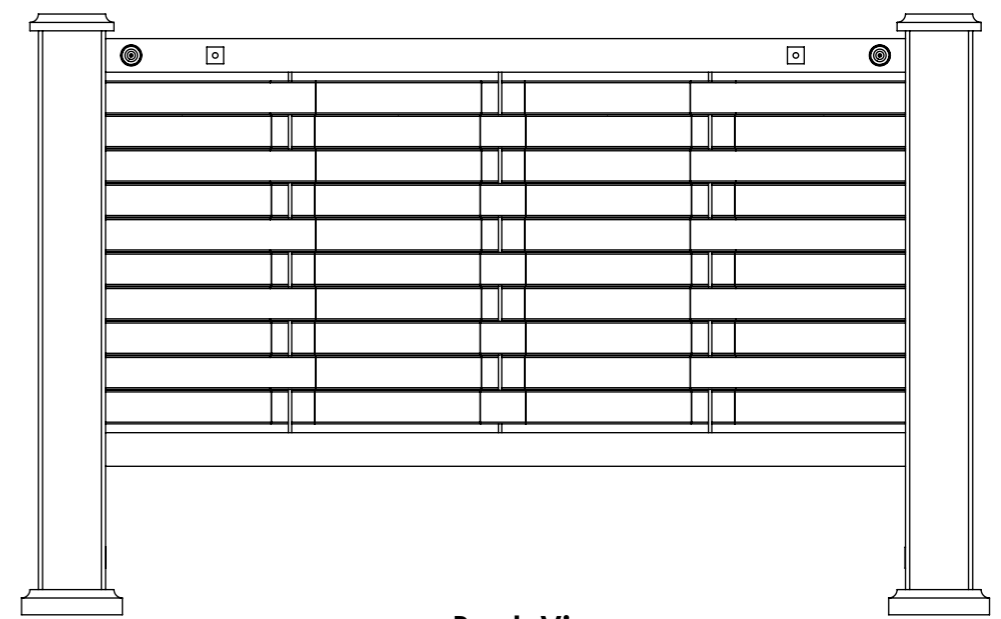

Back View

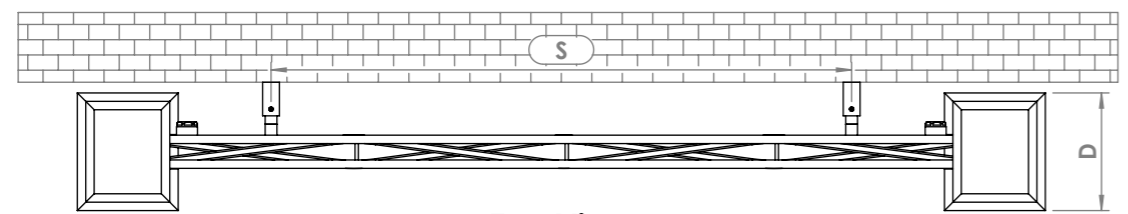

Top View

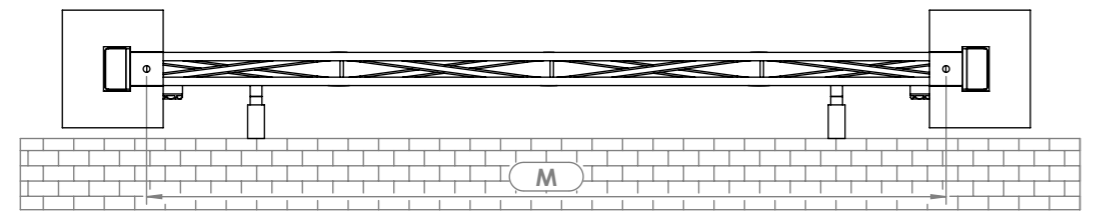

Bottom View

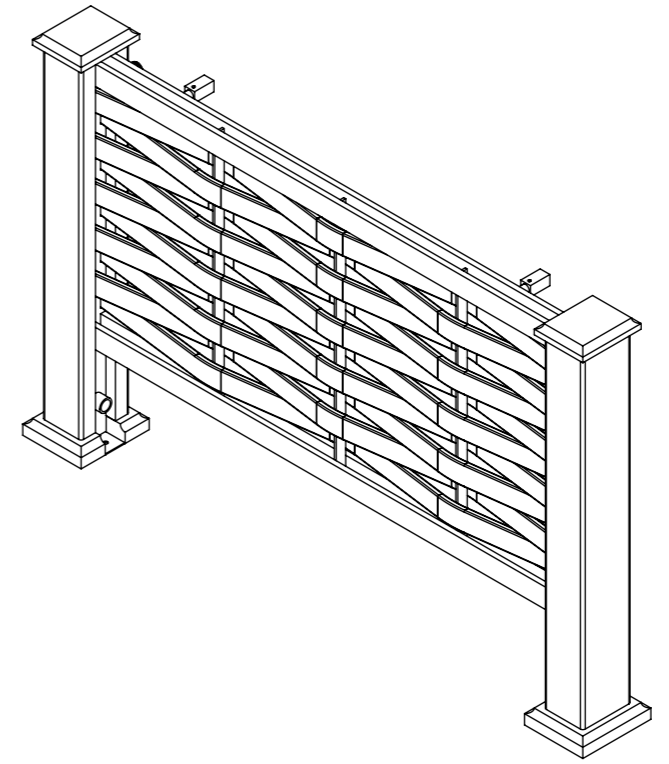



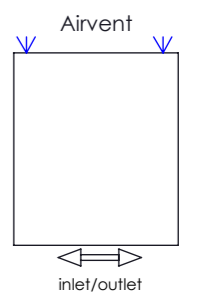



Plumbing Position:



Horizontal mount
 All Dimensions are in mm
 Max. Working Pressure: 8 Bar
 Max. Working Temperature: 95° C
 Inlet / Outlet : 1/2" BSP
 Fuel : H

Manufacturing Tolerance : - 5 mm

Installation Accessories:

-  x2  x4
-  x4  x2
-  x2  x1

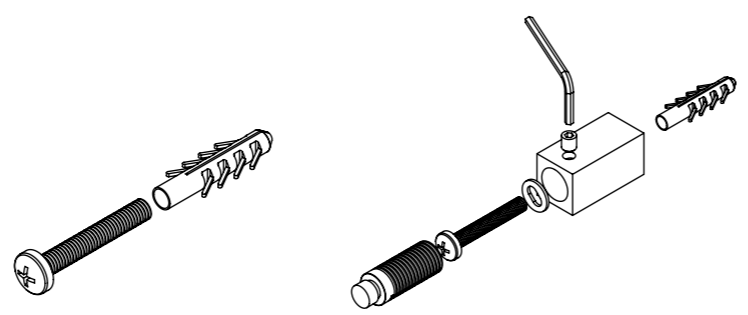

Height H mm	Length L mm	Depth D mm	Pipe Centres C mm	Heat Output	
				BTU	Watts
700	1141	100	860	3897	1141
700	1712	100	1360	5846	1712
700	2282	100	1860	7793	2282