

Front View

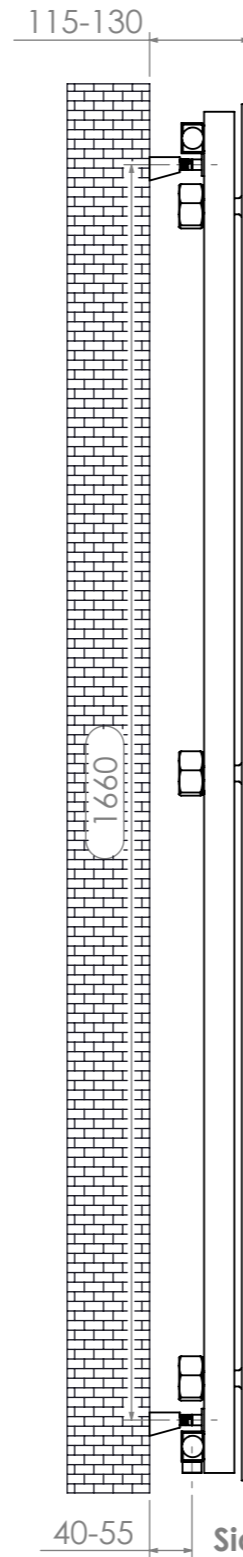

Side View

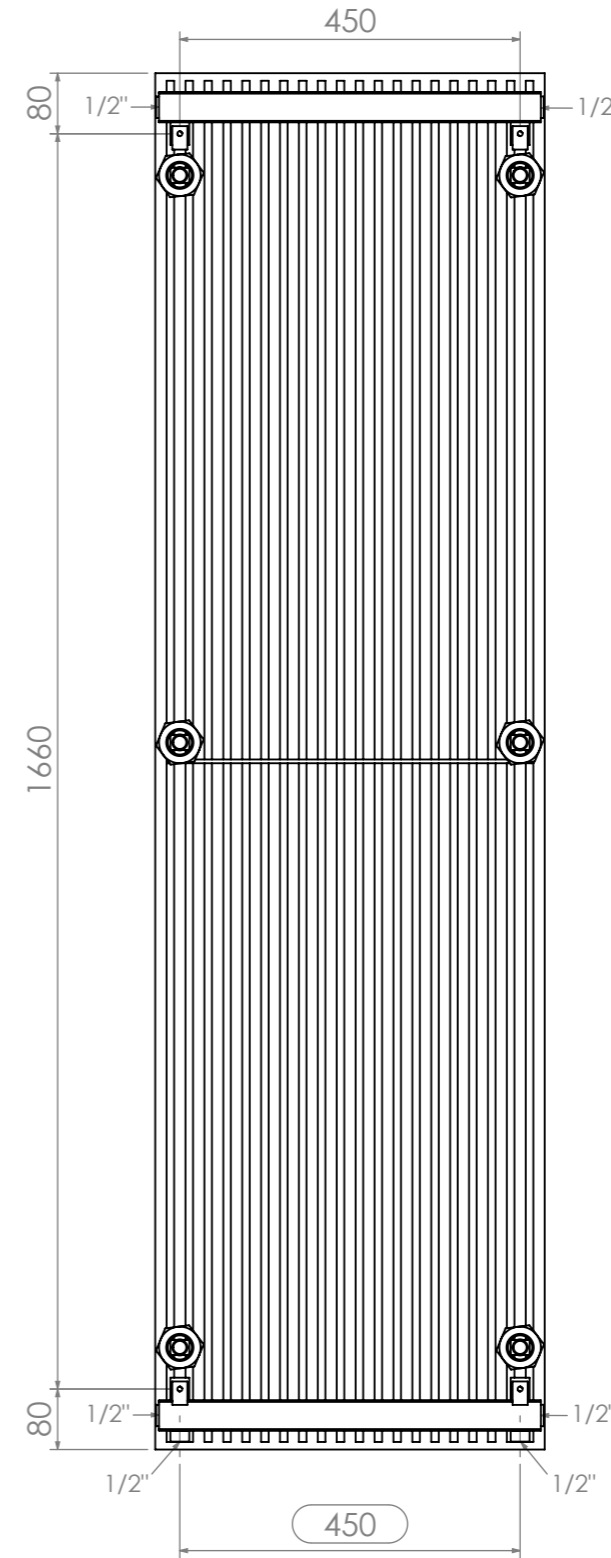



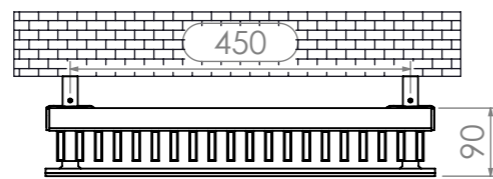
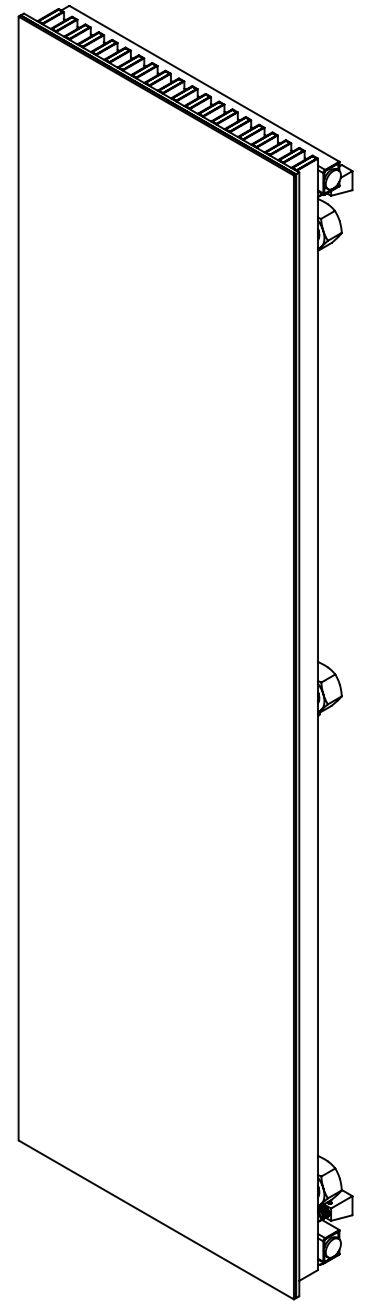

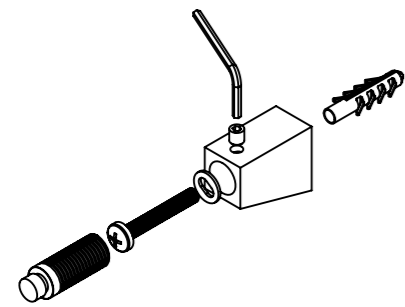

Back View



Top View



Installation Accesories:

-  x4  x4
-  x4  x4
-  x4  x1

Fitting Position:

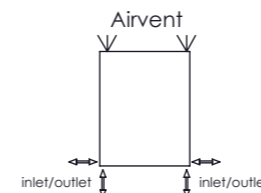

Vertical/horizontal mount
 All Dimension are in mm
 Max.Working Pressure = 10 Bar
 Max.Working Temperature=95° C
 Inlet / Outlet : 1/2" BSP

Height H	Length L	Depth D	Pipe Centres C1-C	Heat Output	
				BTU	Watts
1820 mm	515 mm	90 mm	450-50 mm	9290	2720