

Front View

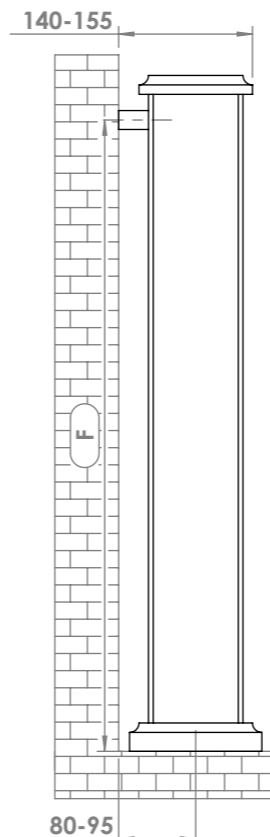

Side View

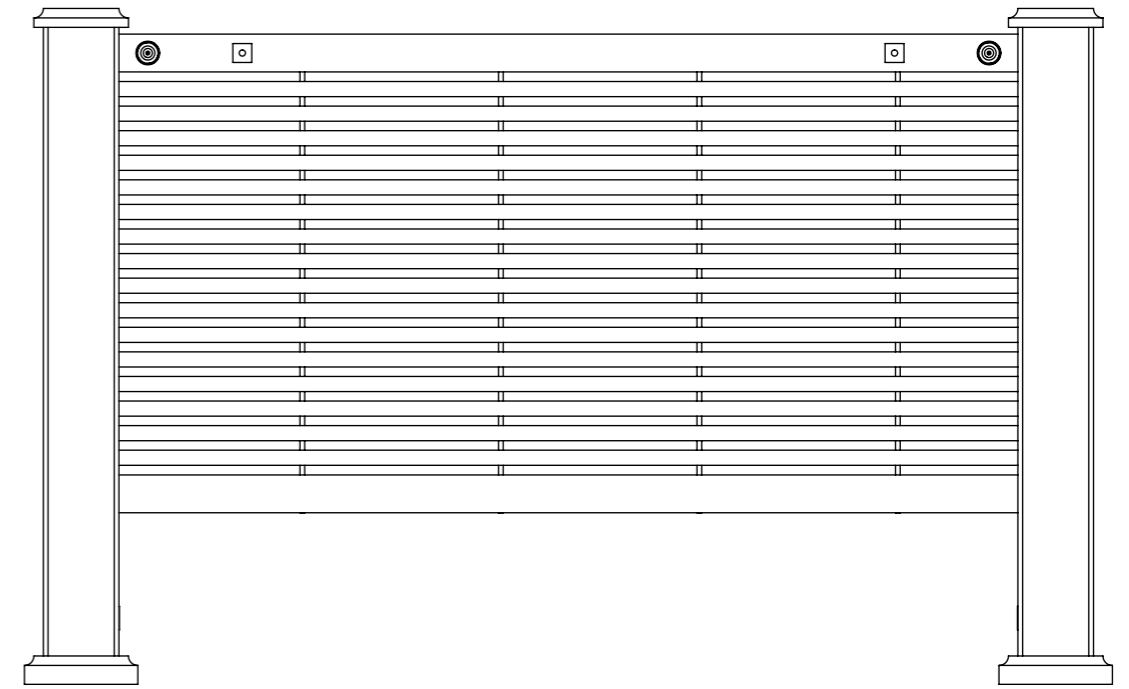

Back View

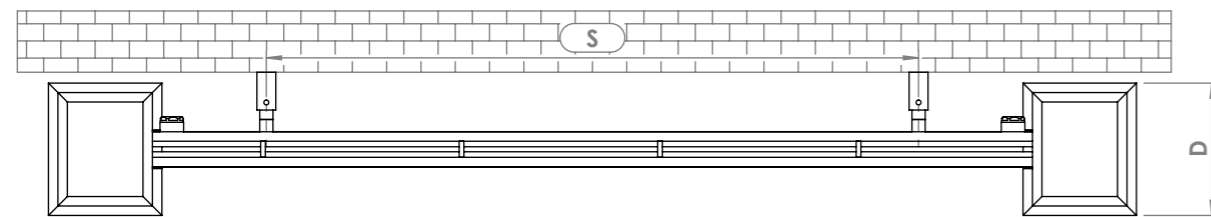
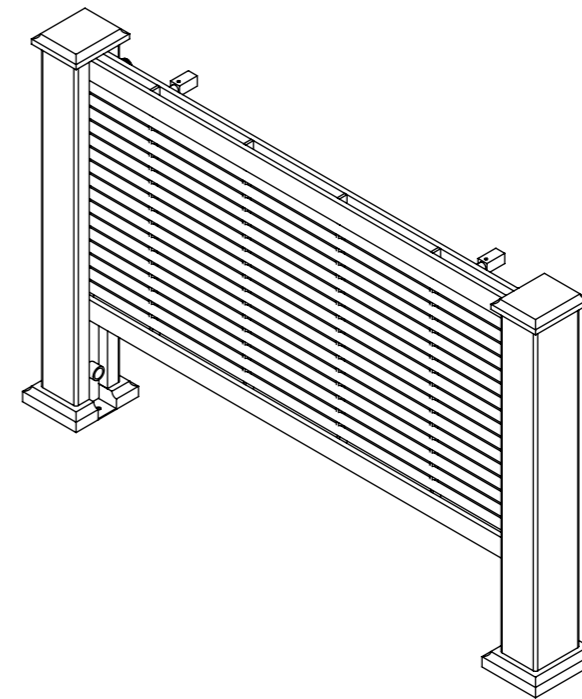

Top View

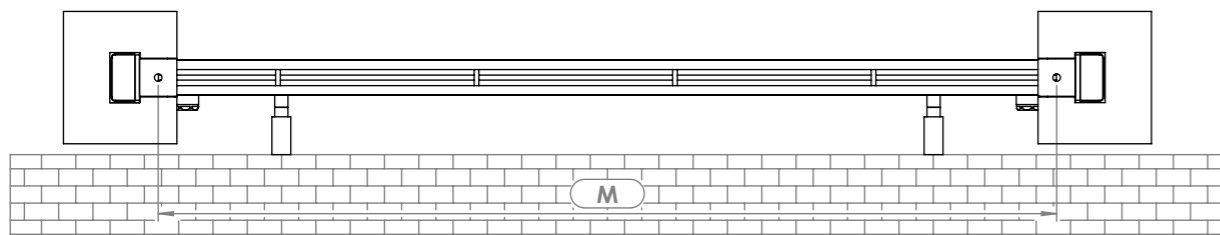

Bottom View



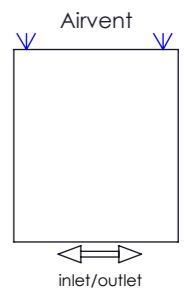



### Plumbing Position:



Vertical mount  
 All Dimensions are in mm  
 Max. Working Pressure: 10 Bar  
 Max. Working Temperature: 120° C  
 Inlet / Outlet : 1/2" BSP  
 Fuel : H

Manufacturing Tolerance : - 5 mm

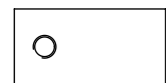
### Installation Accessories:

-  x2       x4
-  x4       x2
-  x2       x1

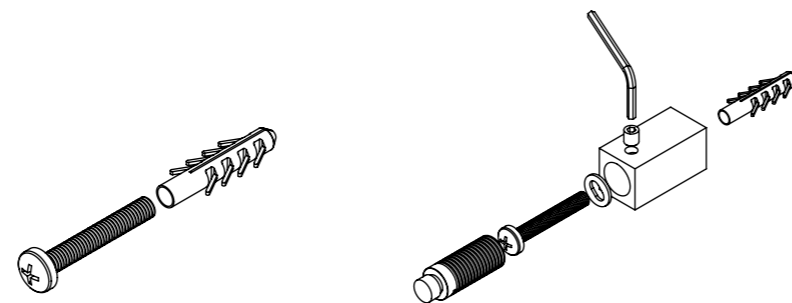

Height H mm	Length L mm	Depth D mm	Pipe Centres C mm	Heat Output	
				BTU	Watts
700	945	100	715	5533	1620
700	1090	100	860	6640	1944
700	1590	100	1360	8115	2376
700	1800	100	1570	8853	2592
700	2090	100	1860	9960	2916