

Luxury Bathroom Solutions **BAMBOO**

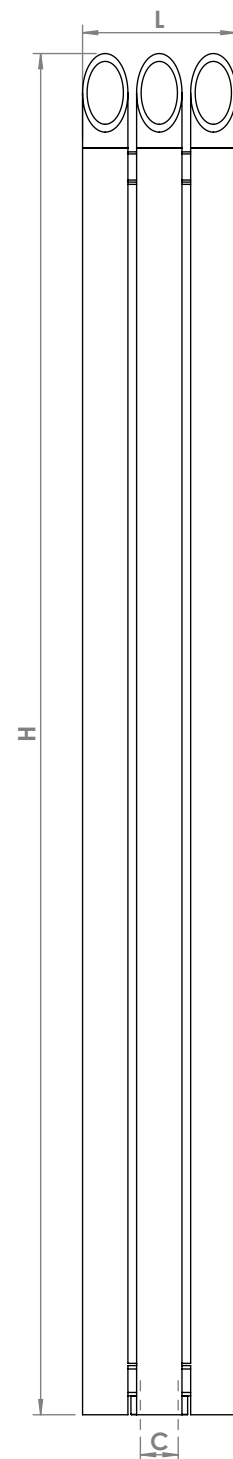

Front View

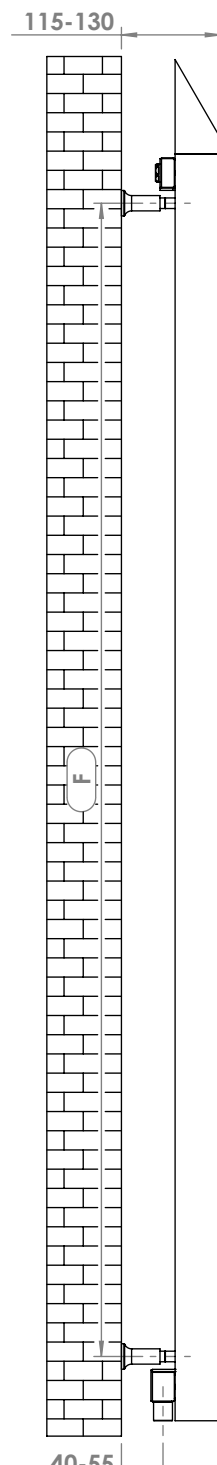

Side View

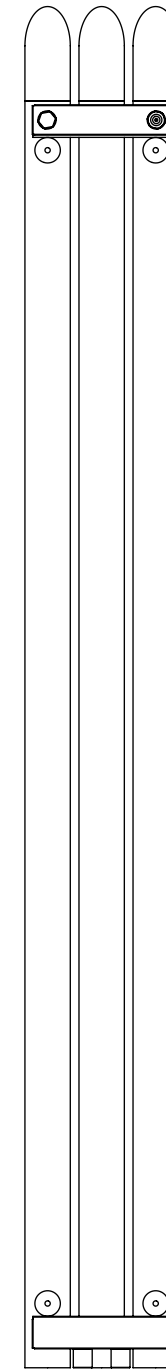

Back View

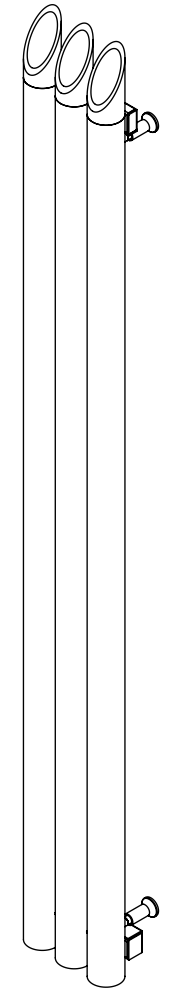

Plumbing Position:

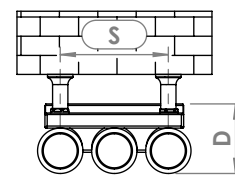
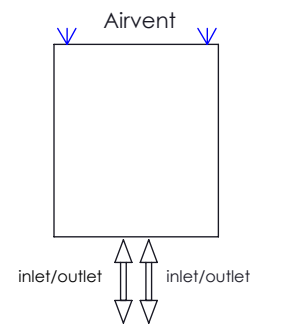

Top View

Installation Accessories:

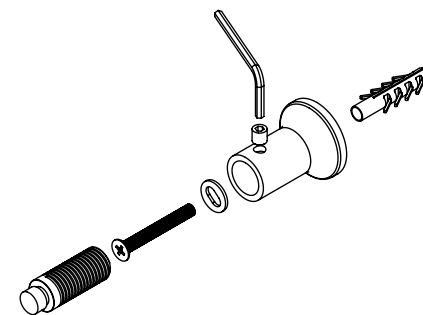
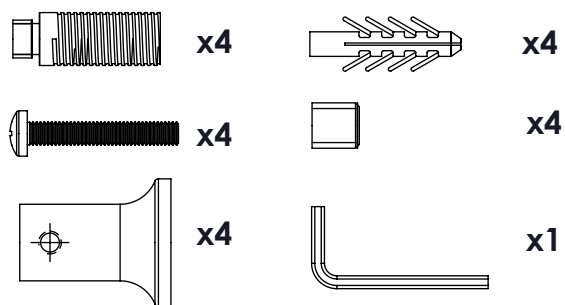

Vertical mount
 All Dimensions are in mm
 Max. Working Pressure: 10 Bar
 Max. Working Temperature: 120° C
 Inlet / Outlet : 1/2" BSP
 Fuel : E/H/D

Manufacturing Tolerance : - 5 mm

Height	Length	Depth	Pipe Centres	Bracket Centres	S	Heat Output	
						BTU	Watts
H	L	D	C	F	S		
mm	mm	mm	mm	mm	mm		
1800	80	60	170	1525	-	1023	300
1800	130	90	50	1525	70	2043	599
1800	200	90	50	1525	140	3066	899
1800	270	90	50	1525	210	4082	1197
1200	550	90	50	925	490	5442	1596