

Front View

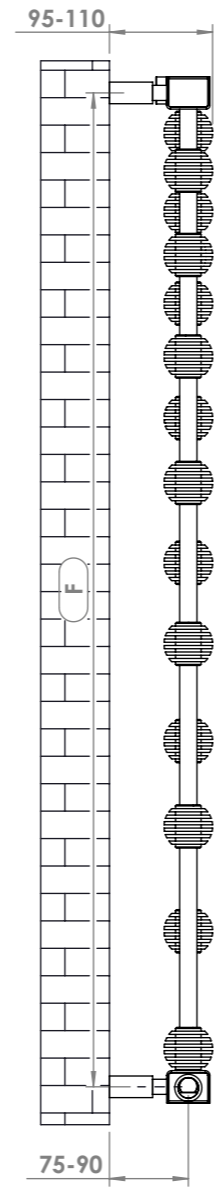

Side View

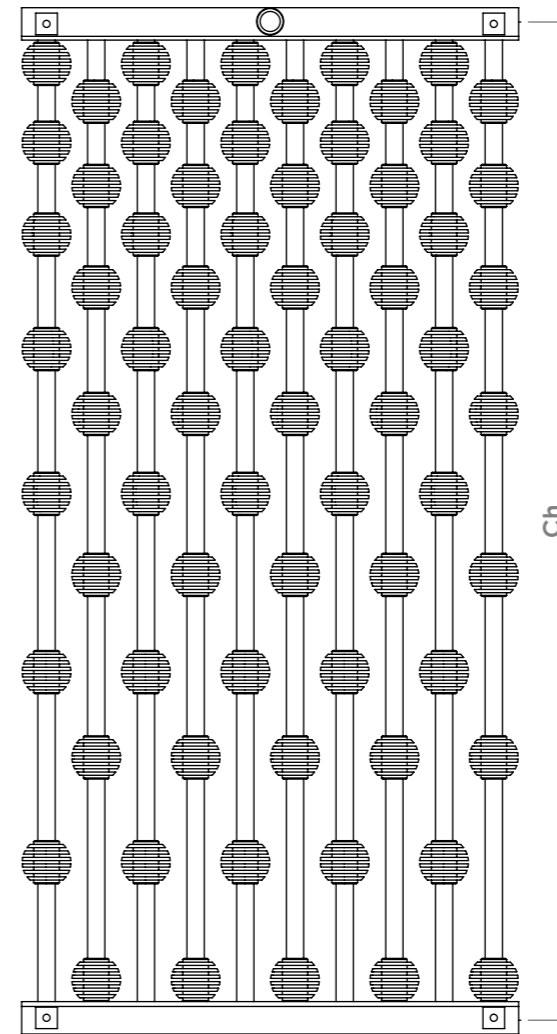



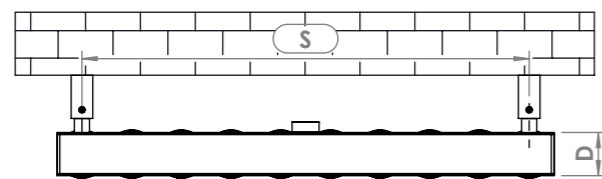
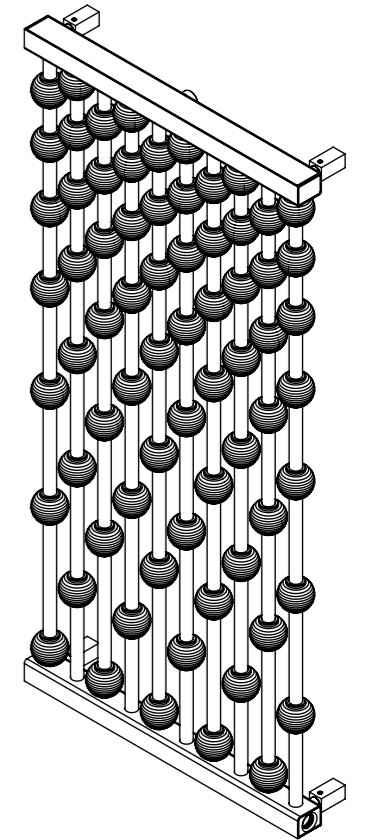



Back View



Top View

Installation Accessories:

-  x4  x4
-  x4  x4
-  x4  x1

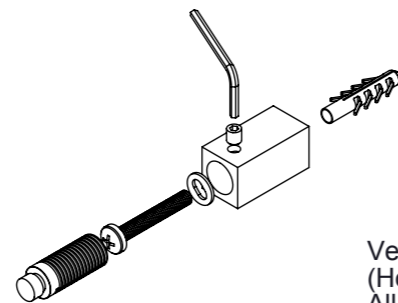

Vertical mount
(Horizontal mount is possible by special order)
All Dimensions are in mm
Max. Working Pressure: 10 Bar
Max. Working Temperature: 120° C
Inlet / Outlet : 1/2" BSP
Fuel : E/H/D

Plumbing Position:

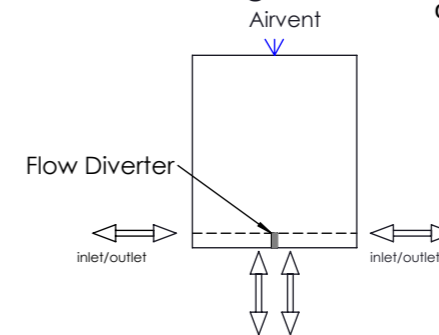

When mounting vertically, please observe that the collector fitted with a flow diverter is mounted at the bottom. This can be verified by visually checking or by referring to the installation diagram

When mounting horizontally, please knock through the centre hole of the diverter using a suitable rod. Please remove the disk if it comes loose and can be removed from a tapping

Manufacturing Tolerance : - 5 mm

Height	Length	Depth	Pipe Centres	Pipe Centres	Bracket Centres		Heat Output	
			Vertical	Horizontal	F	S	BTU	Watts
H	L	D	C-C1	Ch	mm	mm		
mm	mm	mm	mm	mm	mm	mm		
950	460	45	50-550	920	920	414	3349	982
1600	460	45	50-550	1570	1570	414	5159	1513